



Tysons
CORNER CENTER®

TENANT CRITERIA

MACERICH®

VISION STATEMENT

Welcome to Tysons Corner Center.

It is our vision and mission at Macerich to distinguish ourselves through superior performance in retail development and continuous improvement of our portfolio, to meet the changing needs of our customers and the retailers we serve. Our commitment is to furnish a well-designed, well-maintained and well-marketed retail environment, capable of maximizing traffic and sales.

We are pleased to become partners with retailers, striving for the same goals. We are ready to facilitate communication and share our expertise with you to complete your store within expected timelines.

These criteria act as a guide for the design of all work by Tenants in conjunction with the provisions of the Tenant's lease with the Landlord. Tenants are encouraged to express their own unique design statement within the parameters of the Design Criteria as outlined in this manual.

National and regional "standard" Storefront concepts are respected to the extent that they meet the Design Criteria. However, Tenants should be aware that some concept modifications might be necessary to comply with the Center's Criteria.

The same is true for proposed designs that are overly similar to a neighboring Tenant's Storefront design. We wish to make the Mall as diverse and interesting as possible and enable each Tenant to make a singular statement with their design.



CRITERIA MAIN CONTENTS

1.0

INLINE

CRITERIA FOR ARCHITECTURAL, SIGNAGE, AND TECHNICAL DESIGN FOR INLINE RETAIL LOCATIONS.

2.0

FOOD

CRITERIA FOR ARCHITECTURAL, SIGNAGE, AND TECHNICAL DESIGN FOR INLINE FOOD, FOOD COURT/HALL, AND RESTAURANTS.

3.0

KIOSK

CRITERIA FOR THE DESIGN AND CONSTRUCTION OF RETAIL AND FOOD KIOSKS.

4.0

BUILDING DETAILS

ARCHITECTURAL DETAILS, REQUIREMENTS AND REFERENCE PHOTOS BASED ON STORE LOCATION.

5.0

DESIGN INSPIRATION

SUGGESTED DESIGN MOTIFS AND INTRO TO KEY DESIGN ELEMENTS.

6.0

PROPERTY INFO

PROPERTY LOCATION, CONTACTS, UTILITIES OVERVIEW, OPERATIONS, AND LOCAL PERMITTING INFO.

7.0

SUBMITTALS

REQUIREMENTS TO SUBMIT CONSTRUCTION DRAWINGS, RENDERS, SIGN DRAWINGS, AND MATERIAL BOARDS.

8.0

ADDENDUM

SUPPLEMENTAL DESIGN AND CONSTRUCTION REQUIREMENTS AND DETAILS PROVIDED AS LINKS TO EXTERNAL DOCUMENTS.



INTERACTIVE NAVIGATION

This Criteria is an interactive document. You may tap or click the top Navigation Bar or the Side Content Bar to navigate directly to that section.

This page serves as a hub to the various sections included in this Criteria.

The sections in this Criteria break down the key categories of information to understand the design and construction requirements to incorporate a successful retail experience. Refer to the overviews included in the left side bar to learn more about the content included in each section.

It is the responsibility of the Tenant, its contractors, subcontractors, architects, engineers, employees, and agents to comply with terms of the Tenant Criteria, including the supplemental documents included in the Addendum.

The intent of this Criteria manual is to:

- Accelerate the leasing process by providing quick answers to questions about specific requirements.
- Establish the design expectations and technical requirements.
- Establish a coherent design by carefully curating and integrating within the Center.
- Guide the design standards.
- Answer basic questions about the design and construction process.
- Save time by minimizing design reviews.



INLINE RETAIL CONTENT OVERVIEW

1.1

DESIGN

CRITERIA FOR ARCHITECTURAL DESIGN REQUIREMENTS FOR RETAIL STOREFRONTS AND INTERIORS.

1.2

SIGNAGE

CRITERIA FOR PRIMARY AND SECONDARY STOREFRONT AND WINDOW SIGN DESIGNS.

1.3

TECHNICAL

CRITERIA FOR TECHNICAL DESIGN ELEMENTS TO ENSURE YOUR STORE CAN INTERFACE WITH THE PROPERTY'S BASE BUILDING UTILITY SYSTEMS.

SECTIONS OF INTEREST

BUILDING DETAILS

Includes property reference photos and specific Storefront design details.

PROPERTY INFO

Includes information on the Property's building codes, area permitting, and required contractors.

SUBMITTALS

Outlines requirements on how and what to compile for submittals to the Landlord for design reviews.

DESIGN INSPIRATION

Provides visual inspirations for design aesthetics.

The Inline Retail Criteria provides key technical information and design requirements to ensure your store enlivens the consumer experience and interfaces with the Center.

The Tenant and the Tenant's Architect assume the following important obligations:

- Fulfill the intent of the Criteria both in concept and in detail.
- Determine and respond to the actual physical conditions of the Tenant's location.
- Maintain and enhance the high standards of quality established in the construction of the Center.
- Ensure the quality of execution of all design material, finish, and detail concepts in the construction of the Tenant's improvement.
- Provide the required detail at all transitions from Tenant Storefront to neighboring Storefronts, as well as to the base building.



DESIGN CRITERIA

STOREFRONTS

- ENTRY
- POP-OUTS / HEIGHTS
- DIFFUSERS / NEUTRAL PIERS / CONSTRUCTION

DESIGN CONTROL AREA

- DESIGN REQUIREMENTS / WINDOW DISPLAY / PROHIBITED DESIGN ELEMENTS

MATERIALS

- GLAZING / DECORATIVE GLASS
- WOOD / STONE / PLASTER
- METAL / LEATHER
- WALLCOVERINGS / SOLID SURFACE
- PAINT / FAUX FINISHES / FABRIC / TILE

INTERIORS

- LIGHTING / FLOORING
- CEILING / WALLS & PARTITIONS
- EGRESS DOORS / RESTROOM

SECTIONS OF INTEREST

BUILDING DETAILS

Includes property reference photos and specific Storefront design details.

PROPERTY INFO

Includes information on the Property's building codes, area permitting, and required contractors.

SUBMITTALS

Outlines requirements on how and what to compile for submittals to the Landlord for design reviews.

DESIGN INSPIRATION

Provides visual inspirations for design aesthetics.

Tenants are encouraged to express the individuality of their brand through excellent design by forward thinking design teams.

This Design Criteria focuses on strong design details visible from the Center common areas. Focusing on a strong Storefront design enlivens the retail experience and draws customers in to shop. Macerich's Design team is always excited to partner with Retailers in curating a unique and memorable shopping experience. Our team is available to collaborate on your enticing Storefront designs. The [DESIGN INSPIRATION](#) section is also a great launching point to explore design concepts and methods to engage customers.

- All Tenants must engage a reputable Architect.
- Design drawings must all be reviewed and Approved by the Landlord.
- All design elements and finishes must adhere to local and national building code requirements.

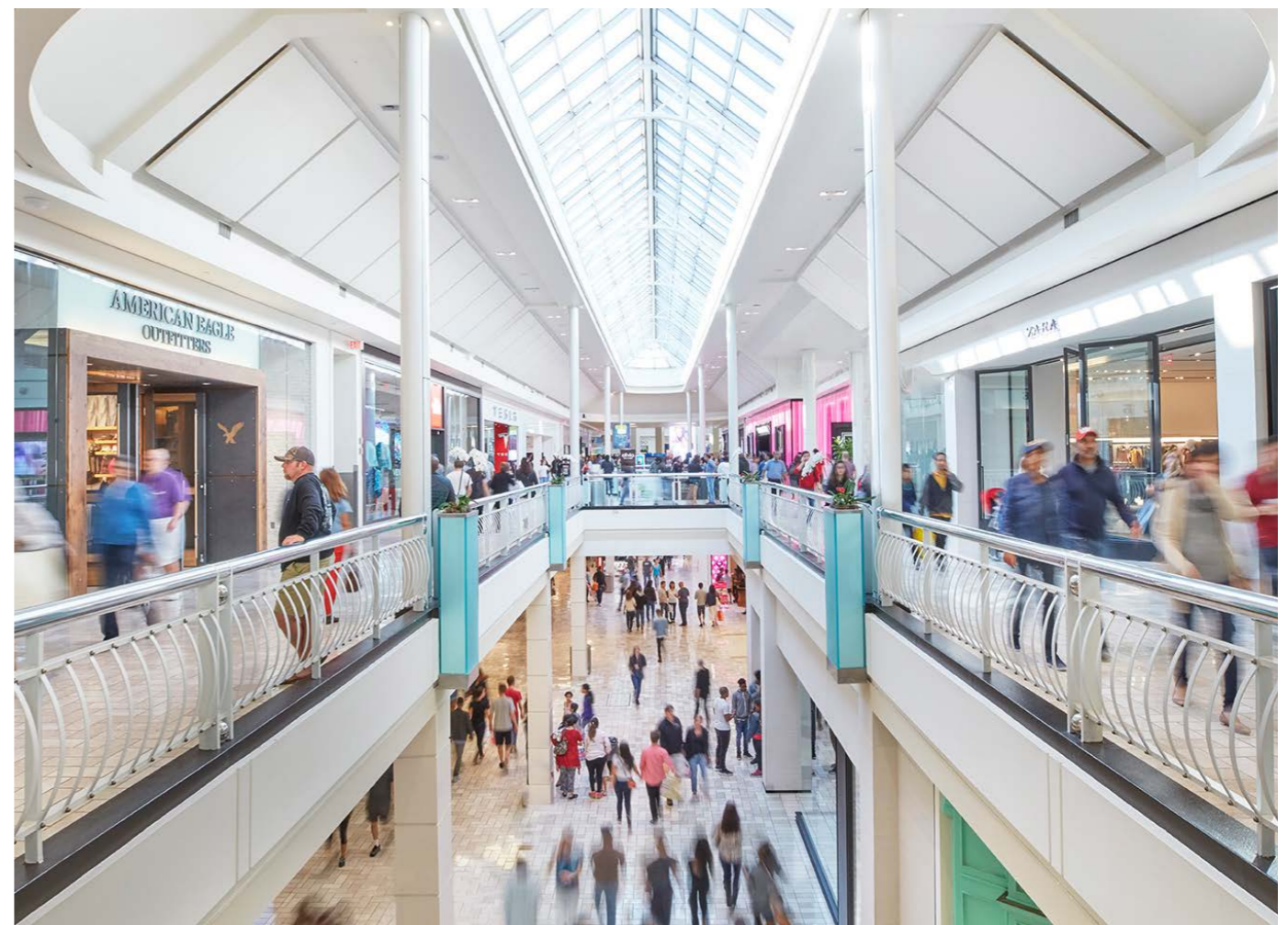

> STOREFRONTS

The Center's success is dependent on the creative design contributed by individual Tenants. It is vital that your Storefront design is integrated with the look and feel of the Center's aesthetic.

The [BUILDING DETAILS](#) section includes specific storefront design requirements based on your store's location. These location based requirements must be incorporated into your Storefront's final design.



> STOREFRONTS > ENTRY

ENTRY

Your Storefront entry is a critical design feature to create an invitation to shop, as such all stores must express the entry as an identifiable part of the Storefront. The underside of the entry portal soffit shall be finished to match the Storefront.

I. SWING DOOR ENTRY

- Swing doors should be located in a recessed vestibule a minimum of 3' from the storefront.
- No door swing shall project beyond the maximum allowable primary projection line.
- Minimum allowable door height is 9'-0".
- All other doors are to be hinged or pivot-type doors. Doors are suggested to be the height of the glazed storefront.
- Recessed entry flooring shall match the Centers' flooring requirements.

II. OPEN STOREFRONT ENTRY

- An open storefront must also present an entry zone. Macerich will review all open storefronts for alternate articulation and dimensional elements for all storefronts.
- Tenants choosing to have an open storefront are required to secure the premises after business hours with a coiling, sliding or folding security closure which comply with the following design guidelines:
 - Shall be set back from the lease line a minimum of 4".
 - Shall coil overhead or coil, fold or slide horizontally to retract into pockets or enclosures to conceal from view during business hours.
 - All supports, tracks, guides and operating devices must be concealed flush with adjacent storefront finishes when closure is in the open position and be integrated into the storefront overall design expression.
 - Horizontal tracks are not allowed in the floor surface.
 - Exposed locking devices or latches are not allowed. Key switches shall be concealed and mounted within the Tenant storefront proper.
 - All supports to be provided by Tenant. Suspending closures from existing building structure is not allowed.

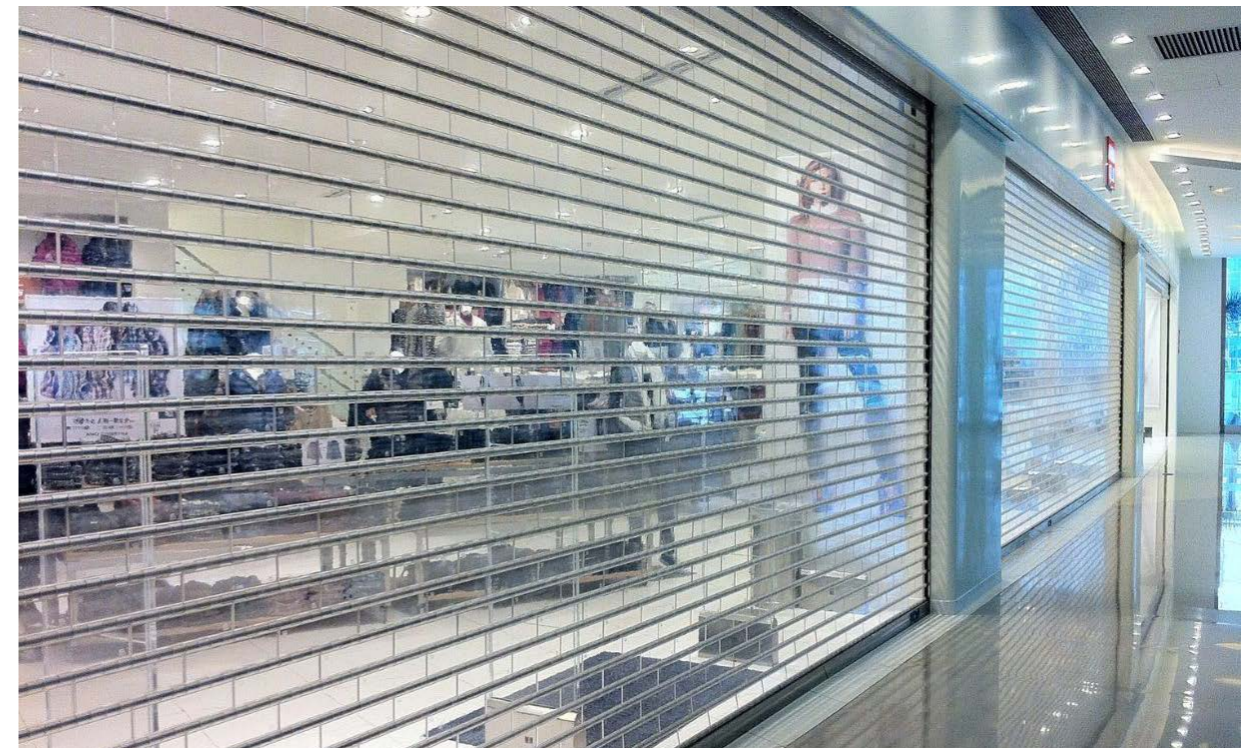

> STOREFRONTS > POP-OUTS / STOREFRONT HEIGHTS

POP-OUTS

Three dimensional pop outs in both plan and height are required for all Storefronts in all new Tenant areas.

- When storefronts are visible from the upper level, special care must be taken so the top is finished to match the Storefront design.
- Exposed conduits, raceways, access panels or equipment may NOT be visible.
- All surfaces of any visible projections must also be finished to match.
- No dust or falling debris may collect on surfaces visible from upper levels. Tenant is responsible for the upkeep of all surfaces.
- Designs may incorporate sloping tops at no less than a 3 in 12 pitch to create a debris resistant surface.

STOREFRONT HEIGHTS

All storefronts must extend up to a maximum height per specific location of your Store:

LOWER LEVEL

- 14'-0" a.f.f. (verify in field) Storefront heights shall terminate at either the ceiling above the store or at 14', whichever is lower.

UPPER LEVEL

- 13'-6" a.f.f



> STOREFRONTS > DIFFUSERS / NEUTRAL PIERS / CONSTRUCTION

STOREFRONT DIFFUSERS

Any existing mall HVAC diffusers within the Tenant Storefront shall be incorporated into the Storefront design utilizing full-width, linear style diffusers. Existing diffusers are rated for approximately 550 cfm.

NEUTRAL PIERS

Specific Neutral Pier requirements based on your store's location are detailed in the [BUILDING DETAILS](#) section.

The following applies to all Tenant designs:

- Regardless of the Neutral Pier condition, the Tenant storefront lease line is marked by the end of the first soldier course of Mall tile that borders the Mall field (Herringbone) pattern.
- The Tenant is responsible for maintaining, protecting, and refurbishing the Neutral Piers as affected by construction or as directed by the Tenant Coordinator.
- Where Tenant finishes terminate at the Neutral Pier, the use of 3/4" metal reveal channel is required. Black is the preferred reveal color. However, the Landlord may require a different color at their discretion.

STOREFRONT CONSTRUCTION

- All storefront construction shall be self-supported from the floor and independent of the building fascia and bulkhead structure.
- Storefronts may be braced to the overhead structure within the Tenant space.
- Connections to the deck, mall mechanical, electrical, plumbing, or fire protection equipment for support is not permitted. This includes ceiling splay wires.



> DESIGN CONTROL AREA

The Design Control Area (DCA) is the zone extended from the storefront lease line to 6'-0" inside your space, including all display windows and retail graphics, display fixtures, signs, materials, finishes, color and lighting fixtures within the area.

At Macerich, we take special interest in the DCA as an extension of the retail presentation and showcase of the store's merchandising. The intent is to convey excitement, and give the consumer a reason to shop.

Use of a professional Visual Merchandisers is highly encouraged. Design drawings shall have a display layout plan. The layout plan shall have cut sheets for fixture and/or mannequin types and include photographs of any existing Storefronts a Tenant may have that will enhance the layout plan. A rendering is required if photographs are not available.

Stores with both interior and exterior presence must activate both DCA areas. Tenants are encouraged to maintain open visibility into their Store to draw in customers.



> DCA > REQUIREMENTS / WINDOW DISPLAYS / PROHIBITED ELEMENTS

DESIGN REQUIREMENTS

- Ceiling must be a hard surface.
- Lighting fixtures must be consistent with the character of the Storefront design.
- Recess all lighting fixtures.
- A minimal profile track lighting system matching the color of the ceiling plane is allowed.
- Hard bases on the walls are required, including any permitted pop out areas.

WINDOW DISPLAYS

Displays should be deliberate and integrated into the Storefront. Modulation of display systems and built-in architectural components will reinforce the design.

- Display cases must be adequately lit and ventilated.
- Digital monitors are permitted within 10'-0" behind glazing if integrated into the design and approved by Landlord. Coordinate with Tenant Coordinator for exterior applications and to confirm code or local requirements.

PROHIBITED DESIGN ELEMENTS

- Temporary signs for sales or clearances shall not be hung in the DCA or affixed to the glass inside or outside.
- No pegboard, slat wall or metal shelving of any kind may be placed in or extend into any part of the DCA.
- Security devices or freestanding pedestals are not permitted. They must be integrated and concealed.
- Carpet, vinyl or rubber materials of any sort will not be permitted within the DCA.
- Exposure of incandescent bulbs and/or fluorescent tubes are not allowed.



> MATERIALS

As an important aspect of presenting the Tenant's unique brand image, finish materials are to be composed, articulated and executed in a creative and quality manner.

All materials and applied finishes on the Storefront are to be high-grade, durable, non-corrosive and code compliant. They are to be maintained by Tenant at the Tenant's expense. All materials and finishes are subject to Landlord approval, and the inclusion of natural materials is encouraged.

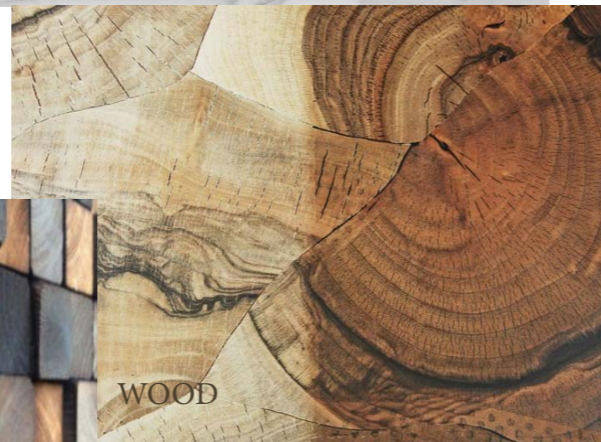

> GLAZING / DECORATIVE GLASS

GLAZING

Storefront glazing, particularly clear glazing, is a key component to establish design character and create an invitation for the customer to visit.

- A minimum of 60% of the Storefront is to be display windows with clear glass.
- Reflective glass (including extensive use of mirror) and/or tinted glass is not permitted on Storefronts or in the Storefront entry zone.
- Tinting or films applied after the glass is installed is prohibited.
- All glass shall be tempered. Glazing must be a minimum of ½" thick, and large panes of glazing must be of sufficient thickness to meet code and be properly supported.
- Tenants may be required to provide seismic clips to stabilize tall expanses of glass. Silicone sealant at glazing joints is not permitted.
- Butt-joint glazing is encouraged for show windows that in-fill larger Storefront forms. Glass shall be clear polished plate or tempered glass as required by code.
- Window mullions are required to meet all material and finish standards.
- Decorative glazing such as colored, beveled, sandblasted or etched glass may be used to create accent pattern and interest. Decorative glazing can be used as an accent, but must meet all material standards.



DECORATIVE GLASS

Decorative glass may be considered to provide a unique feature to the storefront.

- In frame-less assemblies, glass panel joint details edges must be polished, ground or chamfered. Glazing channels at corner conditions must be mitered.
- All exterior glazing units must have a solar heat gain coefficient (SHGC) of not more than 0.27 and a U-value of not more than 0.28.
- Exterior glass must be a minimum of 1" insulated, low E units. 0.27 and a U-value of not more than 0.28.



> WOOD / STONE / PLASTER

WOOD

Wood material can be used for Storefront construction but must comply with all local and national code requirements.

- Applications of painted or stained wood may include window frames, decorative trim, molding and solid areas, such as decorative bulkheads. In some cases, it may be used for larger architectural elements, such as columns and entablatures.
- Wood paneling and plank construction are not acceptable unless presented in a highly imaginative concept and approved by the Landlord.
- Wood specified for interior Storefronts must be kiln dried, mill quality hardwood and must meet local flame spread requirements (Class III 76-200), as well as comply with all code requirements.
- Painted wood must have a shop quality enamel finish. Wood without a paint finish must receive a clear, preservative sealant.
- A mock-up of the materials, colors, textures, or application may be required at Landlord's discretion.



STONE

Granite, marble, limestone, travertine, slate, adoquin and other natural stone materials may be used for storefront applications.

Stone may be polished, unpolished, sandblasted, flamed, honed, split-face or carved.

- Natural stone must be protected against staining and discoloration by means of sealers appropriate to the material.
- Craftsman-like attention to detail is required at all connections and transitions to other materials, and we recommend utilizing metal reveals for a clean finish.
- Corner and edge details must prevent visible unfinished edges. Exposed edges must be quirk mitered, chamfered or polished to match adjacent surface finish.

PLASTER

Cement plaster (stucco) and Venetian plaster finishes may be considered for limited storefront applications.

- Apply an even texture of light dash, sand or smooth finish.
- Plaster or stucco should not be the primary Storefront material. Finishes should be used in combination with other high quality materials.



> METAL / LEATHER

METAL

Metal panel may be used to provide alternate texture on a portion of the storefront.

- High quality is expected for all metal applications, including careful finishing and quality fastener detailing.
- Metals may include: shop-painted aluminum and steel, stainless steel, solid brass, bronze, pewter, or enamel coated steel, and may be used for hardware, trim and panels when well designed and detailed.
- The following notes on metal material details must be called out on the submitted drawing set:
 - Minimum 1/2" thick fire-rated plywood or other solid substrate is required behind all metal panels.
 - Minimum 18 gauge metal panels are required.
 - All seams between metal panels must be identified on the storefront elevation and must be properly addressed during design review process.
- The following metal surface treatments are not allowed:
 - Oil canning (resulting from light reflection on an uneven or buckled surface)
 - Scratches
 - Warps, dents, occlusions
 - Visible seams or other imperfections
- Reveals, turn-in seams, welding or similar must be specified and detailed for approval. Metal panels will not be allowed to directly come into contact with adjacent panel or other materials.
- No visible fasteners are permitted.
- Lap joints and seams must be even, straight, and concealed when possible. Outside corners are to be mitered or continuous break shaped.
- Sealants on natural metals are required to prevent tarnishing and must be maintained by Tenant at Tenant's expense.



LEATHER

The use of leather "tiles" for vertical application can add a level of depth and texture to the storefront. However, these tiles should not be used at an elevation that can be reached by the general population due to the more delicate nature of the finish on these tiles to prevent damage over time.

- The Landlord recommends keeping the use of leather tiles on the storefront above 7'-0" AFF.

> WALLCOVERINGS / SOLID SURFACES

WALLCOVERINGS

Wallcoverings can add depth and texture to Tenant Storefronts, but need to be applied accordingly based on the durability of the product.

Vinyl, Paper, or Fabric Wallcoverings are not considered durable and are expressly prohibited in the use of Tenant Storefronts.

- Any wallcoverings located at pedestrian level (below 7'-0" AFF) must be extremely durable and rated by the manufacturer for high traffic use.
- Any wallcoverings located above pedestrian level (higher than 7'-0" AFF) must be durable and washable for maintenance purposes.
- Removable/repositionable wall coverings are not permitted for Storefront use.
- All wallcovering applications must appear seamless and be securely affixed with commercial grade adhesive rated for high traffic use covering the entire back of the product.
- All maintenance of wallcoverings is by Tenant. No peeling, bubbling, or other separation of the wallcovering from the applied substrate is permitted to remain, and is the responsibility of the Tenant to repair in a time frame deemed acceptable by the Landlord.

SOLID SURFACE

The use of large format solid surface panels can effectively mimic luxury materials in places where cost may be an issue (IE: Caesar Stone or Cambria), or to provide even, diffuse lighting elements in the storefront (IE: Lumicor or 3Form).

- All solid surface products must be rated for heavy duty commercial applications – residential quality products are not permitted.
- Joints, flat seams, and corner conditions of solid surface materials must be tight and seamless.
- All visible edges must be finished to the same level and quality as the front face of the material.
- If the body of the product is not consistent throughout, a mitered corner detail is required to keep the presentation clean.
- All corners and edges must be eased for safety purposes.
- No adhesive can be visible in the final application.



> PAINT / FAUX FINISHES / FABRICS

PAINT

- Surfaces should be maintained as an even surface finish, at all times.
- Any paint application should show uniformity without evidence of touch-ups or batch variation.
- Paint should be colorfast, and well executed to prevent lap marks, brush marks, or poor coverage.
- Surfaces and materials shall be prepared and staged correctly to avoid problem conditions such as poor adhesion, sagging, chipping or flashing.
- Painted metal surfaces are not allowed.
- Painted gypsum board is not permitted on the Storefront.

FAUX FINISHES

Faux finishes may be used at the Landlord's discretion.

- Actual samples of the faux finish must be submitted to the Landlord. Photographs of previous examples are helpful but may not be substituted for an actual sample.
- Faux finishes must be executed by a commercial artisan specializing in that medium.

FABRICS

- Fabrics shall be commercial grade and tested in accordance with ACT Guidelines.
- Specifics for flammability and four aspects of fabric durability: Wet & Dry Crocking, Colorfastness to Light, Physical Properties, and Abrasion are to be documented for each fabric specified and available for Landlord review if requested.

TILE

- Tile may be used in diverse applications and is encouraged to introduce light, texture, and graphic quality to a Storefront.
- Porcelain, cermaic, or glass tile in glazed or natural finishes may be used as accents and in limited field applications. Patterns over a large area must be sophisticated and well executed.
- Small intricate mosaic tile may be utilized for detail and accents only.
- Lapped or butt joints are not permitted. Outside cornered must be bull nose edge or special corner trim.
- Grout color should match the background color of the tile so as not to emphasise the grid.



> INTERIORS > LIGHTING / FLOORING

The store interior design should emphasize your merchandise and create an exciting experience for the customer.

It is the Tenant's responsibility to survey, capture and address all existing conditions within the space.

LIGHTING

Lighting can greatly contribute to the design of a Tenant's store, by emphasizing architectural forms as well as highlighting signage, adding color and visual drama to walls and other design elements. The creative use of dramatic lighting is encouraged at entries, show windows and merchandise displays.

- Fixtures must be positioned to avoid glare directed into public areas. Do not over light.
- Wall sconces or decorative lamping may be used to cast light onto storefront forms, provided that bare bulbs are not exposed and that the finish and form of these fixtures coordinate with the overall Storefront design.
- Fixture cut sheets will be required to be submitted if this light form is used.
- Sconces shall be commercial grade in quality and size.
- Residential scaled sconces are not acceptable.
- Colors are subject to Landlord approval.
- 2'x2' or 2'x4' prismatic fluorescent lights are not allowed.
- All lighting must be LED.



FLOORING

- Flooring is required in the full premises including in the recessed entry conditions and storage areas of the store.
- Recessed entry flooring shall be mall common area tile up to the closure line of the entry doors. Tile is available through mall management.
- Stores with less than 800 sf. require finished flooring with hard surfaces.
- Apron areas must be signed off with the Tenant Coordinator as part of the submittal documentation.
- Hard surface base is required in all sales areas.
- Ensure floor material is durable.
- Carpet must be commercial grade and meet local code required fire-proof ratings.
- Exposed concrete floors must be sealed.
- Transitions between flooring and common areas must be flush.
- Tenant is responsible to mitigate any/all ADA issues and clear with the appropriate municipality.



> CEILING / WALLS & PARTITIONS

CEILING

- Recessed entry conditions must have a finished soffit matching the storefront.
- Concealed light coves to highlight architectural elements are encouraged.
- Multi-level ceilings are encouraged.
- Gypsum wallboard, concealed spline, decorative patterned ceiling panels, and other “high-tech” materials are encouraged.
- Standard 24”x48” acoustical panels are not allowed in sales areas.
- Tenants in Zone 6 shown in the [BUILDING DETAILS](#) section must install a ceiling throughout the entire space due to the plenum return system.

WALLS & PARTITIONS

- Demising walls are not designed to accommodate cantilevered or eccentric loads. If Tenant plans to use a demising wall for support of shelf standards, light softs or heavy attachments, Tenant shall reinforce the wall as required by providing additional steel studs or independent supports for the shelf standards.
- Demising walls and ceiling shall be sound insulated to achieve a minimum STC rating of 50 by Tenants who produce above 80 dB (including but not limited to music stores, arcades, etc.) The Landlord will strictly enforce all Tenant’s right to quiet enjoyment of their Leased Premises.
- Tenant shall protect fire proofed columns and braces with gypsum board, and furr out as required.
- The following are required for hair salons, pet shops and all food preparation type Tenants:
 - Walls containing “wet” areas to be constructed of metal studs with water resistant $\frac{5}{8}$ ” type “x” gypsum board.
 - Demising walls of pet shops shall have sheet metal installed on studs, behind drywall, up 3’-0” from floor.
- When Tenant chooses not to install a ceiling within Tenant’s stockroom, Tenant shall extend the partition separating the stockroom from other areas of the store, to the underside of the structure above in order to isolate the stockroom from the sales area attic space. Tenant to verify if this is allowed by code.
- Metal or plastic laminate inserts are required for slatwall. No visible substrate at slats.
- Recessed wall standards are permitted.
- No open shelving with visible brackets or surface mounted systems are allowed.
- Tenants in Zone 6 shown in the [BUILDING DETAILS](#) section must stop drywall 18”-24” below the deck above to maintain the return plenum.



> EGRESS DOORS / RESTROOM

EGRESS / SERVICE DOORS

- All secondary exit doors shall be backset so that the door does not swing into the corridor, or exit passageway.
- Doors entering a common exit passageway or corridor shall be labeled with the Tenant name and space number.

RESTROOM

- Floor drain and cleanout are required.
- Each restroom must have an exhaust system.
- A waterproof membrane beneath the finish floor surface up to a height of 4'-0" along all walls is required.



> CONTENTS

- PRIMARY SIGNAGE**
 - CONTENT / DESIGN ELEMENTS*
 - PLACEMENT / DIMENSIONS / CONSTRUCTION*

- SECONDARY SIGNAGE**
 - WINDOWS / THRESHOLD*
 - AWNINGS / BLADES / DIGITAL DISPLAYS*
 - PROHIBITED ELEMENTS*

- EXTERIOR SIGNAGE**
 - LIGHTING / DIMENSIONS / DESIGN & FABRICATION*
 - INSTALLATION / SPACE IDENTIFICATION*

SECTIONS OF INTEREST

- BUILDING DETAILS**
Includes property reference photos and specific Storefront design details.

- PROPERTY INFO**
Includes information on the Property's building codes, area permitting, and required contractors.

- SUBMITTALS**
Outlines requirements on how and what to compile for submittals to the Landlord for design reviews.

- ADDENDUM**
Includes additional info on exterior signage requirements.

Storefront signs are vital to the successful function of the Center.

The goal of this Criteria is to produce a colorful collage of signage that tastefully informs, delights, and stimulates the shopper.

All sign materials must be consistent with the design theme, enhancing the storefront and evoking a positive retail image.

Due to the variety of architectural treatments within the Center, each Storefront sign will be carefully considered in relationship to its particular location. What may be appropriate in one location may not work in another. Each proposed sign will be evaluated on its originality and compatibility with neighboring signs, and its overall image within the Shopping Center.

The Landlord reserves the right to disapprove any sign design that is not compatible with these criteria and the aesthetics of the Shopping Center.

This Criteria is intended to harmonize with the leasing documents. It is the responsibility of the Tenant to forward a copy of these Criteria to their architect, contractor and various consultants.

No deviation from the enclosed Criteria requirements will be accepted without prior written approval from Macerich.

Signage design and construction must be code compliant.



> PRIMARY SIGNAGE

Your primary sign is an opportunity to express your Brand's identity and individuality at the entry portal of your store.

The following sign types are encouraged as design options for your primary signage:

- **REVERSE CHANNEL (HALO LETTERS)** minimum of 3" deep and projected from the background.
- **INTERNALLY ILLUMINATED** sign housings having unique shapes with letters routed out and formed letters protruding beyond the routed out letter.
- **EDGE-LIT, SANDBLASTED GLASS** with a continuous light source.
- **CAST METAL LETTERS** raised or flush with the fascia surface.
- **GOLD LEAF** on glass or stone.
- **SILK-SCREENED** glass or metal panels.
- **INDIRECT ILLUMINATION** on non-internally illuminated signs (artisan type panel signs).

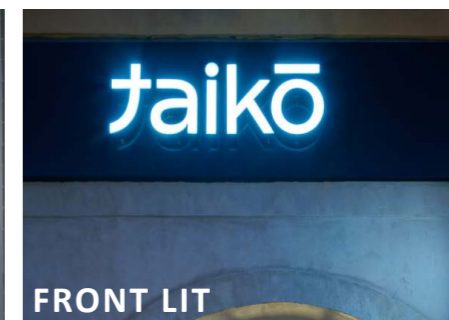
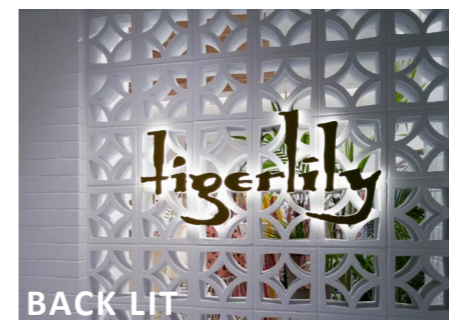

> PRIMARY SIGNAGE > CONTENT / DESIGN ELEMENTS

SIGN CONTENT

- Sign wording is limited to the Tenant's trade name and shall not include specification of merchandise sold or services rendered, regard-less of the Tenant's legal name. Corporate crests, logos or insignia may be acceptable pending the Landlord's approval and provided they are part of the Tenant's name.

SIGN DESIGN ELEMENTS

- All primary Storefront signs must be illuminated. External illumination designs are subject to Landlord approval.
- Imaginative signs utilizing a variety of materials are encouraged. Adaptation of current sign practices may be necessary in order to comply with these criteria.
- Backlit components must be contained wholly within the depth of the letter. Maximum brightness may not exceed one hundred (100) foot-candles.



> PRIMARY SIGNAGE > PLACEMENT / DIMENSIONS / CONSTRUCTION

SIGN PLACEMENT

- One sign is permitted per store frontage unless additional signage is approved by Tenant Coordinator. Tenants occupying corner spaces may utilize one sign per elevation with a maximum of two (2) signs, or one sign on a diagonal corner. For unusually long tenant storefronts, more than one sign may be allowed, with Landlord approval.
- Bottom of sign to be at 9'-0" A.F.F. minimum.

SIGN DIMENSIONS

- Signs shall be designed as an integral part of the storefront, with letter size and location proportional to the overall storefront design, and in compliance with the Design Criteria.
- Letter size: proportional letter required; max allowed for height of letter is 13% of overall storefront height. Example - a storefront that is 12'-0" in height will be allowed to have a maximum letter height of 18.72".
- Letter dimensions of greater proportions may be considered if, in the Landlord's opinion, the sign design is of exceptional merit and architectural quality.

SIGN CONSTRUCTION/INSTALLATION

- All storefront signage and lighting both interior and exterior is required to be on a separate circuit and controlled by a time clock. Storefront Signage and lighting are required to be on during operating hours and off during non-operating hours. This includes exterior building storefront signage.
- Electrical raceways are not to be visible.
- High quality fabrications are required. Hums, flickers and light leaks are not permitted. Attachment devices, bolts, clips, threaded rods, fasteners, tubes, raceways, conduit, and other mechanisms are to be concealed. All labels must be away from public view. Signs must comply with all codes and regulations, must bear the UL label, and must have current sign permits.
- Tenant may use Landlord bulkhead for lateral bracing only.
- Threaded rods or anchor bolts shall be used to mount sign letters spaced out from background pane. Angle clips attached to letter sides will not be permitted. All bolts, fastenings, and clips shall be of hot-dipped galvanized iron, stainless steel, aluminum, brass or bronze, and no black iron materials of any type shall be permitted.
- Advertising placards, banners, pennants, names, insignia, trade-marks and other descriptive material may not be attached to the storefront or glazing.
- Visible weep holes are not permitted.
- Any existing holes from previous Tenant signage must be patched and painted.



> SECONDARY SIGNAGE

In addition to the Primary Sign, all Signage visible from the exterior of the store are considered Tenant Signs. These do not include messages used to advertise products, sales, or special events. Several various Secondary Signs are allowed at the Center and detailed in this section.

The following general Secondary Sign requirements must be met by all Sign varieties:

GENERAL

- Signs must be kept within the projection.
- Signs must be in proportion to the overall storefront and composition.

MESSAGING

- Trade name and logo only, are allowed.
- No taglines may be incorporated.
- Established logos will be allowed and will be counted in the overall area calculations.



> SECONDARY SIGNAGE > WINDOW / THRESHOLD

Secondary signage types and their requirements include:

STOREFRONT WINDOW SIGNS

If the Tenant wishes to provide additional tenant identity, it is to be located at the pedestrian level on the inside face of the storefront glass.

- Glazing signs are to be translucent (similar to frosted glass), reverse-reading and applied directly to the interior of the glass surface.
- Tenant graphics on storefront glass shall be computer cut fat vinyl graphics (text/letter/logos)
- Maximum allowable area of signage is subject to Landlord's review and approval.
- Tenant graphics/logo will be limited to a maximum of three (3") inches in height.

THRESHOLD SIGNS

In addition to storefront signs, Tenants are encouraged to incorporate signs into their entry way flooring. Landlord will review threshold signs on an individual basis.

- Threshold signs are to be graphics comprised of logos, crests and accent.
- Finish is to be flush with adjacent materials and consistent with entry flooring quality.
- Recommended materials are wood, tile, stone, metal and terrazzo inlays.
- Threshold signs are not to extend beyond their lease line into the Center.



> SECONDARY SIGNAGE > AWNINGS / BLADE SIGNS / DIGITAL DISPLAYS

AWNINGS

Some Tenant storefront designs include projected awnings. Landlord will review awnings and their signage on an individual basis.

- Glass or metal are the preferred materials of choice, although fabric awnings will be considered.
- Awning signage may be considered as the main Tenant's identification at the sole discretion of the Landlord in the interior of the Mall only.
- Signage may occur on the valence of the awning and may be painted or silk screened in a contrasting color.
- Logos shall be silk-screened and submitted with awning and sign drawings. Size of the logo shall be proportionate to the overall width of the awning and subject to Landlords approval.
- The lowest point of the awning or shade shall be a minimum of eight feet (8'-0") above the finished floor. It is the designer's responsibility to ensure that awnings conform to all applicable codes.
- Materials such as Pana-flex, plastic or other vinyl materials shall not be permitted.
- Awnings shall be cleared and maintained in good condition at the sole expense of the Tenant's.
- Wording on awnings is limited to Tenant's DBA only.



BLADE SIGNS

Blade signs are not permitted at Tysons Corner Center.

DIGITAL DISPLAY

Storefront window digital display signs must meet the following requirements:

- The display is integrated into the Storefront design.
- Pole mounted monitors are not permitted.



> SECONDARY SIGNAGE > PROHIBITED SIGNS AND MATERIALS

PROHIBITED SIGNS AND MATERIALS

The following sign types and materials are not permitted:

- Internally illuminated plexi-faced channel letters.
- Vacuum-formed or injection-molded plastic signs.
- Cabinet or standard “can type” signs with illuminated translucent backgrounds and silhouetted letters.
- Exposed skeleton neon applied directly to fascia element.
- Temporary or ‘sales’ signs attached to storefront.
- Freestanding tripod signs.
- Flashing, scintillating, moving, sequencing, audible or odor producing signs.
- Paper, cardboard and Styrofoam signs.
- Credit card and advertising placards, decals, stickers or trademarks.
- Manufacturer labels.
- Carpet or rubber entry mat signs.
- Internally illuminated awnings.
- Signs employing un-edged or uncapped plastic logos or letters with no returns and exposed fastenings.
- No simulated materials (IE: wood grained plastic laminates, Zolatone etc.) or wall covering permitted.

> EXTERIOR SIGNAGE > LIGHTING / DIMENSION / DESIGN & FABRICATION

The following additional requirements must also be followed regarding Exterior Signage:

LIGHTING REQUIREMENTS

- Metal letters, back lit (halo effect) with warm white light (3200K^o - 3500K^o). Letters must be a minimum of 6" in depth, and must be projected from the background with one inch spacers.
- Internally illuminated channel letters, with opaque sides and plastic faces, (3200K^o - 3500K^o) luminous tubing illumination within letters. Letters should not be more than 9" in depth. The Plexi-glass color will be determined on an individual mall basis. Trim caps are to match letter color.

DIMENSION REQUIREMENTS

Coordinate with your Tenant Coordinator on the allowable sign dimensions for your design.

- Store sign shall not exceed 70% of the storefront width, a distance which shall be determined by the lineal footage of the Tenants lease line.
- Logos cannot exceed 30" square depending upon the application.
- Uppercase letters shall not exceed 24" in height.
- Lowercase letters shall not exceed 20" in height

DESIGN AND FABRICATION REQUIREMENTS

- Letters are to be individually illuminated with white neon. The "Plexiglas" color is to be determined on an individual mall basis. Trim caps are to match letter color.
- No exposed raceways, crossovers, conduit conductors, transformers, etc. shall be permitted.
- All signage and sign components shall be UL listed.
- No exposed raceways, crossovers, conduit conductors, transformers, etc. shall be permitted.
- All exterior signage components (logos and all individual letters) shall stand off the face of the wall surface by a distance of 1/4 inch. This shall be accomplished by the use of nylon spacers placed between the face of the wall and the back of the logo or letter.
- All metal letters shall be fabricated using full-welded construction.



> EXTERIOR SIGNAGE > INSTALLATION / SPACE IDENTIFICATION

INSTALL AND CONSTRUCTION REQUIREMENTS

- A building permit, Mall and City approval shall be obtained prior to sign installation.
- All sign installation will be coordinated with the Landlord prior to initiation of any work by the Tenant and/or his subcontractors.
- Tenant is responsible for the operation of the Tenant's sign contractor.
- The sign contractor, on drawings submitted to the Landlord, shall indicate location of all openings for conduit sleeves and supports in sign panels of building walls. Sign contractor shall install signage in accordance with the approved drawings.
- Tenant's sign contractor shall repair any damage to any finishes caused by his work.
- PK housing (or other U.L. approved insulating sleeve approved by Landlord and local building codes) is required for all through wall penetrations and must be indicated on the sign shop drawings.
- All signs, bolts, fastenings, and clips shall be of hot-dipped galvanized iron, stainless steel, aluminum, brass or bronze, and no black iron materials of any type shall be permitted. No toggle bolts shall be used for sign attachments.
- Electrical service to the Tenant's sign shall be installed by the Tenant and not be part of the Landlord's operating costs. The sign shall be controlled by a time clock.
- Any existing holes from previous Tenant signage must be patched and painted.

EXTERIOR SPACE IDENTIFICATION

- If Tenant has a non-customer door for receiving merchandise, Tenant may place its name and address on said door in a location approved in writing by Landlord's tenant coordinator, using two inch (2") high block letters. Where more than one (1) Tenant uses the same door, each name and address may be applied. Landlord's Tenant Coordinator shall also specify the size, type and color of numbers.
- Tenant may install on its Mall Storefront, if required by the US Postal Service, only the numbers of Tenant's street address and only in such location as Landlord shall specify. Landlord's Tenant Coordinator shall also specify size, type and color of numbers.



TECHNICAL CRITERIA > CONTENTS

- ELECTRICAL**
 - POWER SOURCE / METER / LOW VOLTAGE*
 - REQUIREMENTS / SYSTEM REUSE*
 - DATA & COMMUNICATIONS*
 - LIGHTING*
- LIFE SAFETY**
 - SPRINKLER*
 - FIRE ALARM*
 - EGRESS*
- PLUMBING**
 - REQUIREMENTS*
 - GAS*
- MECHANICAL**
 - GENERAL REQUIREMENTS / EXISTING SYSTEMS*
 - LOAD CALCS / BMS / EXHUAUST / ROOFTOP EQUIPMENT*
 - ZONE 1-4 & 7 SYSTEM DETAILS*
 - ZONE 6 VAV SYSTEM DETAILS*
- STRUCTURAL / EXIT CORRIDORS**

SECTIONS OF INTEREST

- BUILDING DETAILS**

Includes Property reference photos and specific Storefront design details.
- PROPERTY INFO**

Includes information on the Property's building codes, area permitting, and required contractors.
- SUBMITTALS**

Outlines requirements on how and what to compile for submittals to the Landlord for design reviews.
- ADDENDUM**

Includes additional info on exterior signage requirements.

The Inline Technical Criteria provides buildings details and design requirements for the Center's technical systems.

It is the Tenant's responsibility to verify existing conditions and comply with all applicable codes and standards for technical systems.

Tenants are required to adhere to the full Criteria during their design and construction.

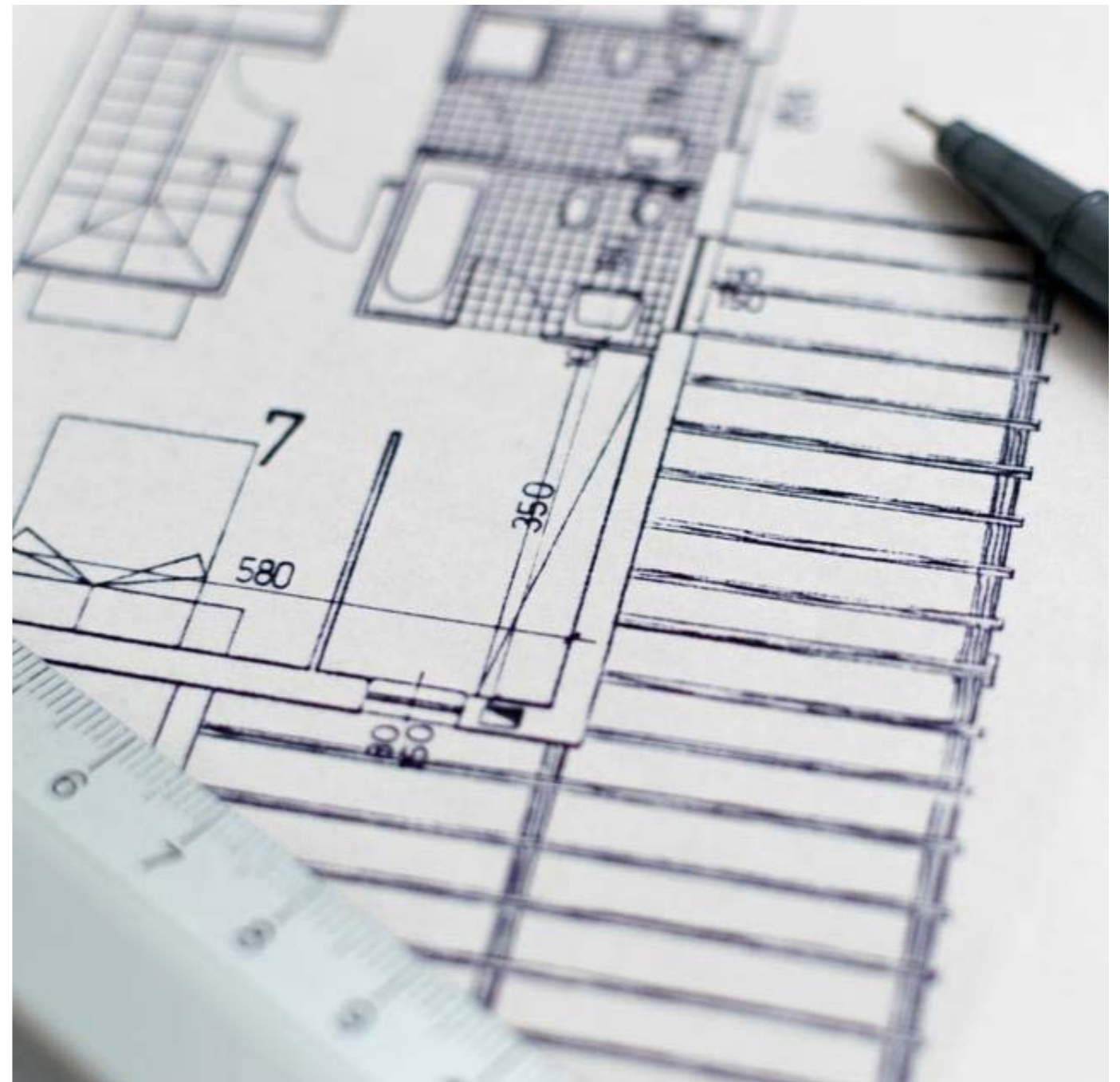

> ELECTRICAL > POWER SOURCE / METER / LOW VOLTAGE

PROVIDED POWER SOURCE

Tenant shell spaces typically provide an empty conduit to a main power source. The main power source available for Tenant connections will be 277/480v, 3 phase, 4 wire available from the nearest electrical room.

I. TENANT REQUIREMENTS

Tenants are required to meet the following requirements related to connecting to their power source:

- **MAIN POWER SOURCE CONNECTION** must be performed by the Landlord's designated electrician, at the Tenant's expense.
- **FEEDERS** to the tenant space are the Tenants responsibility, installation of a dry type transformer, panels and complete distribution throughout their space.
- **LARGER CONDUIT**, if required, is a Tenant responsibility to install from the power source to the demised premises.

METER DETAILS

Electrical use is charged by the Landlord per the Lease. Electrical meters are not permitted.

LOW VOLTAGE SPECIFICATIONS

Specification sheets for Low Voltage base building equipment in Zones 1-5 are in Exhibit 4 included in the [ADDENDUM: EXHIBIT 4. ELECTRICAL SPECS ZONES 1 THRU 5.](#)

Refer to the [BUILDING DETAILS](#) sections to locate your store's Zone location.

> ELECTRICAL > REQUIREMENTS / REUSE

SYSTEM REQUIREMENTS

- **NO DIRECT ATTACHMENT** to the slab, roof deck, ceiling system, ductwork, piping or conduit above. Conduit and raceway hangers, clamps, light fixtures, junction boxes, supports, etc. must be fastened to joists and/or beams.
- **ACCESS PANELS** must be provided at all junction box locations and at smoke detectors above the ceiling.
- **IDENTIFY** all Tenant equipment in the Mall electric room with clear labels that include the Tenant name and space number with panel ID and circuit number. Location of the equipment must be approved prior to installation..
- **TENANT EQUIPMENT** typically includes, but is not limited to: all outlet boxes, floor boxes, wire raceways, power/telephone poles, plug-in molding, wiring devices, and hanger supports for a complete distribution must be furnished and installed by Tenant.
- **EQUIPMENT POWERED BY TENANT** typically includes, but is not limited to: VAV units, water heater, store fixtures, signage, music systems and any other fixtures or equipment provided by Tenant.
- **FEEDERS** are typically the Tenant responsibility to the Tenant space.
- **UL LABELS** on all material and equipment must be new and of a commercial grade and where such labeling applies.
- **WATERTIGHT FLOOR BOXES** are required.
- **PULL BOXES/J-BOX MATERIAL** must be a minimum of 12 gauge galvanized steel outlets. Boxes in walls must be galvanized pressed steel or case metal. Caulk around boxes to eliminate noise transmission.
- **CONTROLS** including Manual or magnetic starters, switches, contactors, relays, time switches, safety devices, dimmers and other controls must be commercial type with heavy duty ratings and must be installed in strict conformance with the manufacturer's recommendation and applicable codes.
- **EXPOSED WIRING** is not permitted. All wiring of any type must be installed in conduit or must be metal clad cable (MC). Metal clad cable will only be allowed for concealed branch circuit wiring within the demised premises. Flexible conduits must be used for connections to vibrating equipment.

- **COPPER** is required for all wiring.
- **CONDUIT** is required for all wiring, including low voltage.
- **MAIN CIRCUIT BREAKER** for the Tenant will be furnished and installed by the Landlord at the Tenant's expense.
- **SERVICE SIZE** requested by Tenant is subject to approval by Landlord. If the Tenant's electrical requirements exceed the standard size provided by the Landlord, the Tenant will submit total Load Calculations to confirm their requirement. Tenant is responsible to confirm the service size before work commences.
- **SLAB TRENCHING** is not permitted without written permission from the Landlord. Tenant to provide all structural support needed if trenching is permitted, including written certification to the Landlord that the trenching has not affected the integrity or weighty capacity of the slab.
- **GRADE LEVEL SLAB** requires electrical conduit to be installed at least 4" under the slab with Schedule 40 PVC conduit. Conduit must not be installed in the slab or less than 4" below slab.

REUSE OF EXISTING ELECTRICAL SYSTEMS

Tenant's electing to re-use the existing electrical system (if applicable) in their Tenant space shall:

- **SUBMIT A LETTER** to the Landlord from the Tenant's electrical engineer stating that the existing electrical system is not being altered.
- **VERIFY SYSTEM CONNECTS** to the building management system for lighting controls and Fire Alarm. Tenant shall use mall required contractor at Tenant's expense to ensure code-compliant, connected system is complete.
- **TENANT IS REQUIRED** to circuit trace and label all circuits that are being reused.

> ELECTRICAL > DATA & COMMUNICATIONS / LIGHTING

DATA AND COMMUNICATIONS – INSTALL AND PROVIDER REQUIREMENTS

Telecommunications service is provided and administered throughout the Center by Granite Grid. The service includes a dedicated concierge customer service representative for each Tenant, high-bandwidth service (tailored to suit Tenant demand), centrally coordinated installations, moves and repairs.

- **ACCOUNT SETUP AND SERVICE INSTALLATION** is the Tenant responsibility to coordinate direct through Granite Grid. Other data providers are not permitted at this property as they do not have an access agreement in place. ****It is highly recommended to coordinate service install a minimum of 4 weeks in advance.**
- **WIRING IN COMMON ELECTRICAL ROOM** must be performed by Landlord's approved subcontractor.
- **TELEPHONE SERVICE** is the Tenant responsibility to contact the local Telephone Company and install within their premises.

LIGHTING – SYSTEM REQUIREMENTS

- **LIGHTING IN TENANT SPACE** is the Tenant's responsibility. The Tenant will not install any lighting outside the Tenant's space with the exception of Mall required standard lighting at back doors. These fixtures shall be photo cell controlled.
- **LIGHTING SCHEDULE** is required for review in conjunction with a reflected ceiling plan.
- **TIME CLOCK** is required to control display window lighting and be on during the hours the Shopping Center is open.
- **DISPLAY WINDOW LIGHTING** at the ceiling must be glare-free and at approved levels at the storefront glass line and not hang down below the top of storefront glass.
- **RECESSED LED LIGHTS** are permitted.
- **DECORATIVE LIGHTING FIXTURES** for storefront illumination, such as luminous ceilings, chandeliers, pendant or wall units or clear type glitter strips are permitted if approved by Landlord. No strobe, spinner or chase type lighting shall be used.
- **CODE REQUIRED LIGHTING** such as exit, emergency and night lights must be provided throughout.
- **SALES AREA LED LIGHTING** must be recessed and must use metal parabolic louver type lenses with a minimum of 18 cell configuration for a standard 2' x 2' fixture. Bare lamp LED or LED fixtures with acrylic prismatic lenses may be used only in concealed areas or stock rooms.
- **TRACK LIGHTING** may be used if the track is painted to match the ceiling color.
- **LIGHTING CONTROL SYSTEM** is the Tenant responsibility, including connection to the Building Management system and connection to the Fire Alarm system.

> LIFE SAFETY > SPRINKLER / FIRE ALARM / EGRESS

SPRINKLER SYSTEM REQUIREMENTS

- **SPRINKLER MODIFICATIONS** are the Tenant's responsibility, designed and installed in accordance with NFPA 13.
- **SPRINKLER DESIGN AND INSTALLATION** must be performed by the mall required sprinkler contractor.
- **DESIGN CONTROL AREA** requires flush mount heads.
- **FIRE EXTINGUISHER REQUIREMENTS** are the Tenant's responsibility to confirm with the local or state fire marshal relating to quantity and location of fire extinguishers. At minimum, Tenant is to install at least one wall hung, 2A 10BC dry type U.L.- listed fire extinguisher.
- **PIPING** must be as close to walls and as high to underside of roof framing as possible.
- **LANDLORD NOTIFICATION** is required in writing at least 24 hours in advance of making any modifications to the sprinkler systems. Contractor must notify the fire department and any alarm monitoring company for verification that the system is fully drained. The contractor must notify the Landlord when the system is back on line.
- **CLEARING ALARMS** must be coordinated with Security or Mall maintenance supervisor at least 60 minutes prior to any drain down. Contractor shall remain for one (1) hour after the system has been refilled to check for leaks or other problems.
- **OVERNIGHT DRAINING** is not permitted. All systems have to be charged and operational when worker leave for the night.
- **SPRINKLER WORK HOURS** all sprinkler work at Tysons Corner Center must be completed after mall hours (overnight). See the Tenant Contractor's Rules and Regulations for the cost for each shut down of the system, which is required to be paid before the system is drained. The Mall staff or approved contractor will drain and fill the system.

FIRE ALARM SYSTEM

Details on the Fire Alarm System Interface are located in the [ADDENDUM: EXHIBIT 2. FIRE ALARM SYSTEM INTERFACE](#).

FIRE ALARM REQUIREMENTS

- **FIRE ALARM DETECTION SYSTEM** is a Tenant responsibility to provide within the Tenant space as an extension of the Landlord's building-wide addressable fire alarm system.
- **FIRE ALARM INSTALLATION** must be performed by the Landlord's designated contractor.
- **FIRE ALARM TIE-IN** to the building wide addressable system must be performed by the Landlord's designated contractor.

FIRE ALARM ZONE REQUIREMENTS

The following requirements are location specific depending on the store's location within the Center. Refer to the [BUILDING DETAILS](#) sections to identify the Zone assignment for your store. These requirements do not replace individual Tenant code requirements based on occupancy or use.

ALL ZONES

All tenants will be required to install fire alarm systems complying with the requirements below.

TENANT INTERFACE CONNECTION BOX (TIC):

Tenant shall provide a minimum 8" x 8" RED Tenant Interface Connection (TIC), located in the Back of House corridor or at an approved location. Terminal cabinet shall include two (2) sets of four (4) pair terminal strips with screw terminals. Provide all cabling and conduit between the FATC and dedicated Fire Alarm Control Panel (FACP) within tenant space. Provide adequate cabling between FACP and TIC for a Signaling Line Circuit (SLC), Visual Notification Appliance Circuit (NAC) activation/synchronization, and Emergency Voice Alarm Evacuation audio circuit.

TENANT FIRE ALARM CONTROL PANEL (FACP):

Tenant shall provide an Emergency Voice Alarm Evacuation system throughout their space with the capability to accept and rebroadcast an Emergency Voice Alarm signal generated by the centers main Fire Alarm Control Panel. The tenant dedicated FACP shall be capable of accepting and rebroadcasting either a 70.7V RMS audio or 1 V peak-to-peak line level audio signal generated by the centers main FACP.

ZONES 1-5 & 7

If Tenant HVAC unit is over 2000 CFM, Tenant will be required to install a duct mounted smoke detector, per IMC requirements, connected to the Mall fire alarm system. A connection point is provided adjacent to the Tenant space in the service corridor. The Mall required fire alarm contractor is to be used at Tenant expense.

ZONE 6

This Tenant zone was previously required to have smoke evacuation and smoke detection systems within each of the Tenant spaces. These are no longer requirements. Tenants in this zone are required to remove all smoke detection/fire alarm devices, and associated wiring in the Tenant space prior to store opening. The Mall required fire alarm contractor is to be used at Tenant's expense for all fire alarm removals, permitting and re-programming of the Landlord system.

EGRESS REQUIREMENTS

- **ALLOWED UTILITIES** in exit passageways are limited to; Electrical wiring (no higher than 480 volts phase-to-phase and 277 volts phase to-neutral) in electrical conduit, Low-voltage wiring (security, music, telephone, data, etc.), enclosed junction boxes, Fire alarm equipment and wiring, Noncombustible piping, and Mechanical ductwork.
- **PROHIBITED UTILITIES** in exit passageways include; Electrical equipment such as panels, switchgear, and transformers, Grease traps, and Natural Gas piping.

> PLUMBING > METER / SYSTEM REQUIREMENTS

SYSTEM OVERVIEW

Tenant shell spaces are typically provided a domestic cold water line and sanitary line stubbed into the space.

The following criteria must be followed during the design and construction of the Tenant space:

WATER METER REQUIREMENTS

- **INSTALL** must be by a Landlord's designated controls contractor.
- **DEVICE** must be a MultiMag Cold Water Meter. See [WATER METER SPECIFICATIONS](#) linked in the [ADDENDUM](#) for device specifics.
- **VERIFICATION AND APPROVAL** of install must be obtained by the Operations Manager, or a member of the Operations staff at the property.
- **PROOF OF INSPECTION** sent to the Tenant Coordinator including:
 - Date of installation or recommissioning
 - Meter make and model
 - Picture of the meter at time of installation or recommissioning
 - Units that the meter reads in
 - Multiplier, if applicable
 - Confirmation that the meter covers whole tenant space

SYSTEM REQUIREMENTS

- **SHUT OFF VALVE** located at eye level in a wall behind a labeled access door is required. Locate in or near employee restroom and/or as designated by Landlord.
- **COPPER** is required for all domestic supply lines and condensate lines.
- **ELECTRIC WATER HEATERS** are required for domestic hot water.
- **SANITARY VENTS** through the roof shall be a minimum of 4" and extend a minimum of 8" above finish roof. All roof repairs to be by the Landlord's required roofer at Tenant's expense.
- **ABOVE GROUND SANITARY VENTS** (other than food waste) must be service weight BUILcast iron, with fittings matching the same weight as the pipe.
- **FLOOR DRAINS** are required in the toilet room and in all "wet" areas. All floor drains must have trap primer.
- **WATERPROOFING** must be installed in all "wet areas" such as kitchens, restrooms, mop sinks, drinking fountains, etc. The waterproof membrane must extend 4" vertically on all demising walls. This membrane will be water tested by the General Contractor and inspected and signed off by Mall Personnel. If the membrane fails the water test, it must be replaced.

- **CLEAN OUTS** must terminate flush with the finish floor or wall. No clean outs are permitted above the ceiling. Floor or wall cleanouts must be provided every 50' with ready access.
- **GARBAGE DISPOSALS** are not allowed.
- **HAIR SALONS/PET SHOPS** must provide hair and solids interceptors on all sinks and basins which may receive human or animal hair. After installation, these hair interceptors shall be properly maintained so as to keep the sanitary system free from any adverse conditions. A maintenance contract with Mall-approved vendor is required to be submitted for record with Mall Operations
- **HAIR RECEPTORS** must be installed on all sinks, basins, and special sanitary units which may in any way receive human or animal hair.
- **KITCHEN SINKS** including pot sinks, scullery sinks, pre-wash sinks and other kitchen units must be connected to a grease trap.
- **DISHWASHERS** may not be connected to grease trap.
- **GREASE INTERCEPTOR** must be designed and approved by Landlord prior to installation, especially if located outside the lease line.
- **OIL COLLECTION AND HAULING SYSTEM** is required for Tenants with fryers or other grease/oil generating equipment that does not run through an interceptor. Landlord does not provide a centralized collection point.
- **BACKFLOW PREVENTERS** are required for food service, hair salons or other Tenants with equipment or operations that have the possibility of backflow. These must be certified and acceptable to the water district and checked yearly or as required by the local authority having jurisdiction.
- **ADA RESTROOMS** are required in every Tenant space with a minimum of one water closet and one lavatory and in accordance with local code officials and must include a 3" floor drain. Mop sinks and water fountains must be installed per local code requirements. An exception to this requirement is only permitted for Food Court Tenants who are within close proximity to the public restrooms upon approval of the Landlord and local code official.
- **WATERLESS URINALS** are required in tenant restrooms when urinals are used.
- **LOW-FLOW WATER CLOSETS** using 1.6 GPF or less gallons per flush are required where water closets are used.
- **OPERATION SENSORS AND LOW-FLOW HEADS** using 0.5 GPM or less are required if Tenant is installing a Restroom.

> PLUMBING > GAS

GAS SERVICE

Gas may be available at the Center but is generally not available to Retail Tenants. If available, Tenant, at its sole cost and expense and in compliance with local code must procure gas service to and within the demised premises and will make all necessary arrangements with the local Gas Company for such service.

I. SERVICE REQUIREMENTS

- **GAS METER INSTALLATION** at gas meter header is the responsibility of the Tenant.
- **GAS PIPING INSTALLATION**, when allowed, is the responsibility of the Tenant to provide and install. Roof piping must be placed on pillow blocks or similar arrangement. All roof repairs to be by the Landlord's required roofer at Tenant's expense.
- **PRESSURE REGULATORS** required for connection to Tenant's equipment is the responsibility of the Tenant. Coordinate with Landlord for regulator vent routing.
- **SEISMIC AND MANUAL SHUTOFF DEVICES** are required for the entire gas piping system and equipment or fixtures and color coded or identified as such as required. Seismic valves must be: UL- approved; FM-approved; or, ACSE 25-compliant. All new development and newly tenanted restaurants need to have seismic gas shut-off valves installed on Landlord side of the meter, at each individual space.

> MECHANICAL > GENERAL / EXISTING

Tyson's Corner Center features various Mechanical systems providing HVAC. The following sections details general requirements as well as the system specific to each Zone as highlighted in the [BUILDING DETAILS](#) section.

MECHANICAL SYSTEMS OVERVIEW

Tyson's Corner Center utilizes three separate mechanical systems to provide HVAC based on your store's location:

ZONE 1-4, 7

- Tenants in these Zones are typically on a Chilled Water System.

ZONE 5

- Food Court Tenants in Zone 5 are on an Individual Rooftop System.

ZONE 6

- Tenants in this Zone are on typically on a Shared VAV System.

GENERAL REQUIREMENTS

- **VIBRATION ISOLATORS** are required to be installed on all HVAC equipment, whether on the roof or within the Tenants space.
- **MAXIMUM NOISE** criteria of NC40 is required for all spaces except kitchens and other similar work areas.
- **DUCT MOUNTED SMOKE DETECTORS** are required for systems that total 2,000 CFM or greater and must be connected to the main fire alarm panel, if applicable. Each duct smoke detector must have a remote key operated reset/test device mounted within the Tenant space and an addressable relay module. Use Landlord's designated contractor for connection to the main fire alarm loop. The cost associated in monitoring Tenant's space will be the Tenant's responsibility and will be included in Tenants monthly billing.
- **AIR BALANCE REPORT** is required prior to closing out construction and will be performed by an independent test and balancing agency at the sole cost and expense of the Tenant.
- **UNUSED EXISTING EQUIPMENT** shall be completely removed. Do not abandon in place.

EXISTING SYSTEMS

The Lease may allow some Tenants to reuse existing HVAC system equipment. In such cases, the following requirements must be followed:

- **CONFIRM** the existing system meets the Tenant Criteria requirements.
- **REPLACE** any units the Landlord deems in need of replacing. This may occur anytime during the terms of the Lease. Replaced units must adhere to the Tenant Criteria.
- **REUSE** of equipment older than 5 years is not permitted.
- **ALTERATION** of the existing system must be submitted and approved by the Landlord.
- **SUBMIT DOCUMENTATION** of the following prior to opening:
 1. A letter from an HVAC contractor asserting that the HVAC unit(s) operate in "like-new" condition.
 2. A copy of the maintenance agreement for the unit(s).
 3. Photographs of the existing unit(s) provided by the Tenant's HVAC maintenance contractor.
- **CLEAN** reused ductwork in accordance with NADCA
- **CLEAN** all unitary equipment and provide new filters. Provide MERV 13 filters.

> MECHANICAL > LOAD CALC/EXHAUST/BMS/ROOFTOP EQUIPMENT

LOAD CALCULATIONS

- **ASHRAE** standards must be followed.
- **TENANTS WITH MULTIPLE ZONES** may use the outside air calculation spreadsheet provided in the [ADDENDUM](#) to comply with Fairfax County Permit Office.

EXHAUST REQUIREMENTS

- **ODOR PRODUCING TENANTS** such as restaurants, pet shops, hair salons, nail salons, and the like must maintain 10% negative air pressure with respect to the Mall by providing make-up air equal to 90% exhaust air volume. Coordinate exterior exhaust locations with existing outside air intakes so that exhaust air does not re-enter the building. As part of the design, tenants may be required to demonstrate with computational fluid dynamics that exhaust air containing objectionable odors do not re-enter the building.
- **OPERATION** of the combined HVAC and exhaust system must be on during all hours that the Tenant is open for business.
- **STORE EXHAUST SOLUTIONS** shall not include air filtration systems or bathroom exhaust fans.

I. KITCHEN EXHAUST REQUIREMENTS

Food Tenants in Zones 2 and 5 shall refer to the Exhaust and Grease system specifications detailed in Exhibit 3 in the [ADDENDUM: EXHIBIT 3. FOOD TENANT EXHAUST AND GREASE SPECS FOR ZONES 2 AND 5.](#)

- **LANDLORD REVIEW** is required to ensure the exhaust does not compromise the ventilation air of adjacent mall roof top units.
- **EXHAUST FAN** must be a SWSI centrifugal fan which must be fitted with a minimum 10' stainless steel upblast. Guy wires must be attached to the roof in order to secure the stack. Use the mall roofer for connection of the guy wires at Tenant's expense.
- **GREASE GUARD CONTAINMENT SYSTEM** (or approved equal) must be installed to protect the Landlord's roof. A quarterly maintenance program must be in-place for the grease containment units. Proof of the maintenance contract must be presented to Operations Manager prior to the store opening.

BUILDING MANAGEMENT SYSTEM

If applicable, Tenant must connect to the Mall's existing Energy Management System. In the process of Tenant renovation, the system must be upgraded to meet current criteria at Tenant's expense. Tenant must contact Landlord's designated contractor for the purchase and installation of the necessary controls and connection to the main control panel.

Duct mounted smoke detectors if required by code, must be connected to the main fire alarm panel, if applicable. Each duct smoke detector must have a remote key operated reset/test device mounted within the Tenant space and an addressable relay module. Use Landlord's designated contractor for connection to the main fire alarm loop.

ROOFTOP EQUIPMENT REQUIREMENTS

- **PIPING** for the rooftop equipment must be provided and installed by the Tenant in coordination with the Landlord. Pipe type and dielectric unions when connection to dissimilar metals
- **INSTALLATION INFRASTRUCTURE** including all curbs, supports, lintels, pipes, ducts, vent caps, air inlets, exhaust hoods, louvres, flashings, counterflashing's, etc. are the Tenants responsibility.
- **CURB ADAPTERS** are not allowed.
- **PAVERS** must be placed around the roof top equipment and from the main pathway to the equipment in order to protect the roof from traffic.
- **EQUIPMENT SCREENS** for rooftop shall meet Landlord requirements.
- **PAINTING EQUIPMENT** including screening, equipment, ductwork, and piping is required to match the roof deck per Landlord specifications.
- **LABELS** are required on all Tenant equipment.
- **ABANDONED EQUIPMENT** must be fully removed, including any associated curbs and patched accordingly.
- **SEAL NEW PIPE PENETRATIONS** though the roof with new prefabricated lead or metal pipe sleeve flashing. Flashing flanges should be installed in a manner acceptable to the roofing manufacturer and the Landlord.
- **CONTROL AND ELECTRICAL WIRING ROOF PENETRATIONS** shall be made through the equipment curb or roofer required flashing.

I. ROOFTOP WORK

- **MALL APPROVED ROOFING CONTRACTOR** is required for all roof work throughout the center.
- **WARRANTY COMPLIANCE** is the responsibility of the Tenant and mall roofing contractor.
- **ROOF ACCESS** shall be coordinated and scheduled through Mall Operations.
- **DAMAGE** to the roof structure caused by hoisting installation and the maintenance and/or servicing of Tenant's equipment will be the sole cost and expense of the Tenant to repair.

> MECHANICAL > ZONES 1-4 & 7

ZONE 1-4 & 7 OVERVIEW

The Tenant provided HVAC system shall be VAV in nature for spaces with multiple zones and/or above approximately 3000 square feet, when required or deemed required by tenant's design engineer, AHU's/Mechanical equipment shall be equipped with a full airside economizer system when sufficient outside air and relief is available.

Single zone and less than 3000 sq. ft. - constant volume AHU's shall be provided with full airside economizer.

VAV AHU's shall utilize variable speed drives for the supply and return/relief fans. Control system shall utilize a BacNet compatible/compliant Direct Digital Control system that incorporates reset strategies for the static pressure setpoint and the supply air temperature setpoint (applicable to VAV), based on the loads being served by the AHU.

This design criteria is intended to guide the Tenant HVAC designer toward the use of a VAV system utilizing variable speed drive based blow through air handling units equipped with full airside economizers, and either return or exhaust/relief fans. Direct drive plug fans are desired but not mandated. Very low face velocity cooling coils are mandated to allow the use of high chilled water supply and return temperatures to improve the chiller plant system efficiency, and to reduce airside pressure drops and fan energy waste to maximize chilled water economizer operation.

AIR HANDLER REQUIREMENTS

- Provide AHU submittal(s) to landlord for review. All chilled water AHU submittals must be submitted to landlord and approved by landlord prior to unit being ordered.
- Commissioning of all AHU's are required once installed and operational. Contractor is responsible for coordinating start-up and com-missioning with landlord representatives. Contractor shall provide landlord a minimum of five (5) days' notice.
- Design Engineer shall note on drawing that the controls submittal shall be provided to landlord for review prior to installation.
- Contractor is responsible for providing controls submittal to landlord for review and approval to verify compatibility with building system. Submit documents on all control product components prior to installation.
- Contractor shall submit to landlord control point list prior to installation.
- Contractor shall submit BACNET conformance compliance statement to landlord prior to installation.
- The following are required from the contractor prior to final vendor contract payment:
 - Certified manufacturer's start-up and test report for all new HVAC units.
 - Certified air and water balancing test reports.
 - Bound O&M manuals for all new HVAC units outlining maintenance procedures, parts list, etc. and hard copies of approved shop drawing submittals.
 - New HVAC units warranty paperwork.

HVAC SYSTEMS DESIGN REQUIREMENTS

- All Tenant HVAC systems must utilize computerized Direct Digital Controls that are native BacNet compatible/compliant. No pneumatic or electric/electronic controls are permitted.
- Maximum outside air supply and re-circulated shall be equal to one hundred percent (100%) of CFM circulated – a full airside economizer is required.
- Minimum outside air supply shall be based the minimum required by applicable codes), plus any additional requirements to maintain air supply equal to total air exhausted. This shall not exceed twenty five percent (25%) of total air volume supplied. The Tenant's air handling system must be designed to operate under all conditions, without the need to relieve air into or take air from the adjacent enclosed mall.
- Fresh air dampers, exhaust fan discharge dampers and relief air dampers shall be low leakage, opposed blade type. Maximum open area face velocity of the various damper systems shall not exceed 800 FPM. Relief/exhaust/return fan with vfd or barometric relief damper/hood shall be provided for 100% outside air economizer mode.
- Air pressure drop in ductwork shall not exceed 0.075 inches H₂O per 100 ft. of straight run. The maximum air velocity in the main duct runs shall not exceed 1,500 FPM, and the maximum air velocity in the duct run-outs to the diffusers shall be 500 FPM. Duct tap-offs shall be made at a 45 degree angle in the direction of air flow. All branches and take-offs shall be equipped with volume controlling devices. All ductwork shall be designed, provided, and installed in accordance with the latest methods use in ASHRAE Guide and the SMACNA Standards.
- Motors shall be designed for variable speed inverter duty (applicable to VAV AHU only) and be rated as premium efficiency based on continuous duty NEMA Standards. Motors rated ½ HP and larger shall be 3-phase, 480 volts, motors rated less than ½ HP shall be single-phase, 120 volts. Provide inverter duty motors with harmonic filters
- Blower motors and other equipment vibrating shall be isolated from unit casing and from construction with vibration absorbing mountings.
- Ceiling diffusers shall be provided with volume control.
- Level One Tenants will need special Landlord permission for shafts or venting through Level Two spaces.

> MECHANICAL > ZONES 1-4 & 7

DESIGN CONDITION DETAILS

Tenant's heating and cooling system design shall be based upon the following conditions:

HEATING

- Inside dry bulb temperature: Sales 72°F Storage 70°F
- Outside dry bulb temperature: 10°F
- Average wind velocity: 7 mph
- When the space is not occupied, minimum temperature shall at no time go below 55°F and only recirculated air may be used by Tenant provided unit heater.

COOLING

- Inside dry bulb temperature: Sales and Storage: 72°F
- Relative humidity (maximum): 50%
- Outside dry bulb: 93°F
- Outside wet bulb: 78°F

LOAD FACTORS

- Roof U-Value: 0.084
- Wall U-Value: 0.300
- Lighting Density-per Lease Outline Drawing (maximum 3.0 watts per square foot of sales floor or customer accessible areas unless approved by Landlord, maximum of 1.5 W/SF for back of house operations).
- Cooling loads associated with lighting densities greater than 3.0 W/SF and 1.5 W/SF shall be cooled by separate tenant provided DX split systems, powered from the tenant meter.
- Population Density - 1 person per 50 sq. ft. of demised space shall be used when developing the cooling calculations and for fresh air requirements. Sensible heat shall be based on 315 BTUH/person,
- Latent heat shall be based on 325 BTUH/person. The square footage to be used for this calculation consists of the entire demised area, not just the customer accessible areas.

HVAC CALCULATION CRITERIA

All calculations shall be in accordance with all the latest edition of the ASHRAE Fundamentals Guide and Data Book, applicable codes and requirements and good engineering practice. All calculations shall be upon the included form, certified by a registered professional engineer and, submitted for Landlord's engineers' approval with final working drawings.

HEATING LOAD

Space shall be calculated to maintain the minimum space temperatures indicated with the equipment for day heating loads. However, no credit may be taken for lighting and people.

HEATING ENERGY SUPPLY

Heating energy supply will be electric and Tenant will make available from Tenant's electric service to power Tenant provided unit heaters.

If an SCR heater is used provide it with a harmonics filter.

COOLING LOAD

Cooling load calculations (lights, equipment and occupants) shall take into account all interior heat producing items, as well as the loads imposed by the fresh air component and the walls, windows, skylights etc. For spaces utilizing full airside economizer, loads exceeding 40.0 BTU per hour per square foot (300 SF/Ton) shall be cooled by separate tenant provided supplemental split system AC unit, powered from the tenant meter, unless approved in advance by the Landlord. For economizer limited tenants, loads exceeding 31.1 BTU per hour per square foot (385 SF/Ton) shall be cooled by a separate tenant provided supplemental split system AC unit.

The minimum outside air shall be provided per code and shall be used when developing the heating and cooling calculations. Outside code calculation spreadsheet similar to that provided (if requested) shall be provided on plans for satisfactory permit review.

The peak design CFM for the AHU shall be based on either the design supply air temperature for the unit on the peak load day, or 63°F supply air temperature based on the peak loads in existence when the OSA temperature is 60°F, whichever is higher.

> MECHANICAL > ZONES 1-4 & 7

COOLING MEDIA/EQUIPMENT

- For the purposes of sizing and selecting the AHU and cooling coils, the temperature of the chilled water supply provided by landlord, if applicable, shall not be less than 50 degrees Fahrenheit EWT and the temperature of the chilled water return provided back to the system by the tenant AHU shall not be less than 64 degrees Fahrenheit.
- If Tenant uses chilled water service it shall be made available during normal “business hours” whenever outdoor temperature is equal to or above 60 degrees Fahrenheit. The temperature will be varied based on the cooling loads being served by the chiller plant, and may be higher or lower than described in this Design Criteria at any given time of day or time of the year.
- Minimum working pressure of all Tenants’ chilled water equipment will be 125 PSIG.
- Maximum allowable pressure drop through all Tenant’s chilled water piping and equipment (measured at connecting points to main) shall be fifteen feet (15’-0”) Water Gauge (WG) at the 14 degree temperature differential described above.
- The cooling coil shall be 5/8” minimum tube diameter, copper with a 0.28” wall thickness minimum. The fin thickness shall be 0.008” minimum.
- The maximum distance between cooling coil drain pans that pass 100% of the way thru the coil finned surface area, shall be 24”. If the cooling coils are taller than 24”, provide intermediate drain pans to limit the vertical distance between drain pans to 24” maximum.
- The cooling coil drain pans and cooling coil casings shall be 304 stainless steel, of adequate thickness to provide the intended duty, and double sloped to encourage water drainage from the drain pans. The drain pans shall drain dry within 15 minutes of the air handling unit being shut down.

I. TENANT’S WITH LIMITED/PARTIAL AIRSIDE ECONOMIZER CAPABILITY

- The tenant shall be responsible for installing an economizer system (fresh air intake duct and return fan system with exhaust ducting) that will utilize the greatest economically feasible amount of fresh air possible. Zones 1-4 shall install a fresh air fan with airflow station to provide the minimum ventilation above when applicable to partial economizer in this zone.
- The cooling coils in the air handling units, the AHU fan system and the distribution ductwork must all be increased in size to meet the tenant calculated peak winter cooling loads when the chiller plant is delivering 60 degree F chilled water temperatures and the ambient conditions are 60 degree F or less. The load being served by the AHU system shall be reduced by the amount of load that can be served with the design volume of fresh air at a 63 degree F supply air temperature from the economizer system. The chiller plant system will be providing flow to the loads at an expected chilled water temperature differential of 10 degree F, so the design chilled water return temperature shall be 70 degree F.
- Since the supply air temperature will be higher than would be delivered in the summer, the supply air volume shall be increased to accommodate the peak loads when using the higher AHU supply air temperatures.
- The AHU’s shall be blow thru in design, to reduce the supply air temperature as far as possible, while increasing the chilled water return temperature.

II. SPECIFIC REQUIREMENTS FOR RESTAURANTS

- There is no requirement for full airside economizer.
- The cooling coils in the air handling units, the AHU fan system and the distribution ductwork must all be increased in size to meet the tenant calculated peak winter cooling loads when the chiller plant is delivering 60 degree F chilled water temperatures and the ambient conditions are 60 degree F or less. The load being served by the AHU system shall be reduced by the amount of load that can be served with the design volume of fresh air at a 63 degree F supply air temperature from the economizer system.
- The chiller plant system will be providing flow to the loads at an expected chilled water temperature differential of 10 degree F, so the design chilled water return temperature shall be 70 degree F.
- Since the supply air temperature will be higher than would be delivered in the summer, the supply air volume shall be increased to accommodate the peak loads when using the higher AHU supply air temperatures.
- The AHU’s shall be blow thru in design, to reduce the supply air temperature as far as possible, while increasing the chilled water return temperature.

> MECHANICAL > ZONES 1-4 & 7

LEVEL TWO TENANTS HEATING AND COOLING AIR SUPPLY SYSTEM

The air supply system for existing Level Two Tenants utilizes a Chilled water cooling coil, as part of air handling unit described, with the following characteristics:

- Entering minimum water temperature: 50 degrees F.
- Water temperature rise across coil: 14 degrees F.
- Minimum number of rows: 8 rows. Fin per inch count: 12 FPI, no more, no less. Coil thickness minimum is 0.028", fin thickness minimum is 0.008" minimum.
- Maximum air pressure drop through coil: 0.70 in WC
- Maximum air face velocity across coil finned surface area: 300 FPM for draw through cooling coil configurations, 350 FPM for blow through cooling coil configurations.
- Maximum water pressure drop through coil (including valves, devices, and connected piping): 15 ft.

I. DESIGN REQUIREMENTS

- BacNet room thermostat governed full modulating two-way throttling type control valve. Belimo Energy Valve - EV Series. Provide with inlet strainer, balancing valve on chilled water circuit of coil, manual and automatic air vents piped to floor sinks, freeze stats, freestats, and one hundred percent (100%) O.A. Economizer, BacNet compliant DDC controls system as described elsewhere, return or relief/exhaust fan, air flow switches and high limit safety cut out for electric coils.
- Electric resistance type heating coil(s) installed in Tenant provided unit heaters shall not exceed 7.5 KW per step and be thermostatically controlled by the DDC system supply air temperature setpoint. The heating system control signal shall be 0% to 100% heating unit output based on the space temperature being between -1.5°F and -5°F of the space temperature setpoint. If an SCR heater is used provide it with a harmonics filter.
- All supply duct work and chilled water piping shall be insulated one inch (1") and condensate lines one-half inch (1/2") with glass fiber with non-combustible UL rated vapor barrier.
- Provide the BacNet interface hardware and software required to send this information to the Landlord DDC system. The Landlord will provide the cable and hardware necessary to receive this information. Provide technical assistance from your DDC system provider to facilitate this interface. Provide IP connection in Tenant control panel for future mall connection for monitoring. The tenant shall obtain the services of the landlord designated controls contractor to provide necessary cabling, hardware and interface work. Tenant controls contractor to provide technical information and coordination to achieve the connection to the landlord DDC system.
- Make and control diagram and description, and equipment submittals Sequence of Control Operation.

- Seasonal selection shall be by fully automatic "Summer – Winter" switch based on outside air temperature. These are generic sequences, the Tenant HVAC Design Engineer shall develop sequences that follow these basic guidelines and reset strategies, adapted for the specific needs of the individual tenant.

II. HEATING AND VENTILATING CYCLE:

DAY CYCLE:

(9am – 10p.m.) on days the Demised Premises is open for business

- BacNet compatible/compliant DDC control system shall energize the supply fan (the fan shall run continuously during the day cycle, utilizing the variable speed drive to maintain the static pressure set-point) and the electric heating coil. If a separate unit heater is utilized, the BacNet DDC system shall also have control of that equipment. Controller of electric heating coil will gradually turn on all circuits. The BacNet compatible/compliant DDC control system shall also energize the outside air, return air and relief air damper motors and place them under the control of the daytime space thermostat setpoint.
- As space temperature increases and approaches the space thermostat setting, the heating coil multi-step controller shall modulate toward the "off" position. When the space temperature has reached 1.5°F below the set point of the thermostat the controller shall have modulated the heating coils to "off".
- The outside air damper shall remain closed until the space temperature approaches the modulating range of the day time space thermostat setpoint at which time a set of contacts controlled by the DDC system shall energize a minimum positioning switch to open the outside air damper to minimum position. An auxiliary switch mounted on the outside air damper motor shall modulate the relief air damper motor open as required. When heating coil control is in the "off" position (coil de-energized) and on a further rise in a room temperature, the economizer control system is enabled and the relief dampers open and return air damper closed to maintain temperature. The return/exhaust/relief fan speed shall be controlled to maintain the relative pressure between the Tenant space and the mall space as described elsewhere. The Freezestat shall override entire system. If the mixed air temperature drops below 45°F, an audible and visual alarm will be sent to the tenants from their DDC system, and the chilled water valve will be opened to the 100% open position. The return/relief/exhaust fan shall be shut down, the relief and fresh air dampers shall be commanded closed and the supply fan shall be shut down.
- When temperature increases above 48°F, the reverse shall occur.
- Low limit controller located in the discharge air shall override the BacNet space thermostat control logic to maintain a minimum discharge air temperature.

> MECHANICAL > ZONES 1-4 & 7

NIGHT CYCLE:

- BacNet compatible/compliant DDC control system shall de-energize the fan circuit and damper motors and place fan operation under the control of the night space thermostat setpoint. The DDC system shall operate the fan intermittently to maintain space temperature. Outside and relief air dampers shall be closed and return air damper open; electric coil shall be operating as in daytime.

INTERLOCKS:

- Interlock will keep electric coil(s) de-energized whenever respective supply fan is not running.
- Whenever electric coil is de-energized, controller shall return to "off" position. The electric coils shall always start unloaded.
- Chilled water coil control valve shall be closed whenever the heating coil system is in operation, except as described by Freez-stat logic.

III. COOLING CYCLE

DAY CYCLE:

- BacNet compatible/compliant DDC control system shall energize the supply fan (the fan shall run continuously during the day cycle) and shall energize the minimum positioning switch of the outside air damper opening same to the minimum position. The economizer system shall be enabled if the outside air temperature is 10°F (adjustable) lower than the return air temperature.
- The DDC system shall vary chilled water flow rate by means of modulating the control valve of the cooling coil to maintain the AHU supply air temperature setpoint. The AHU supply air temperature setpoint shall be reset based on the offset of the space temperature from the space temperature setpoint as described below. The space temperature shall be compared to the space temperature setpoint in control at the zone thermostat. If the space temperature is above or below the setpoint as described below, the supply air temperature setpoint and the static pressure setpoint for the AHU shall be gradually decreased or increased in a proportional manner, each minute, as described in the Sequence sections in the following column.

NIGHT CYCLE:

- This BacNet compatible/compliant DDC control system shall de-energize all systems.

SUPPLY AIR TEMPERATURE SETPOINT RESET SEQUENCE

- If the space temperature is between -0.5°F below the space temperature setpoint and 3.5°F above the space temperature setpoint and the space temperature is increasing, proportionally decrease the supply air temperature setpoint that controls the cooling coil control valve by 0.02°F (adjustable) to 0.15°F (adjustable) each minute that the unit is in operation.
- If the space temperature is more than 1.5°F above the space temperature setpoint whether the space temperature is increasing, decrease the supply air temperature setpoint that controls the cooling
- Coil control valve by 0.12°F (adjustable) each minute that the unit is in operation, in addition to the reset described above. A minimum supply air temperature setpoint of 55°F shall be utilized.
- If the space temperature is between +0.5°F above the space temperature setpoint and -3.5°F below the space temperature setpoint, and the space temperature is decreasing, proportionally increase the supply air temperature setpoint that controls the cooling coil control valve by 0.008°F (adjustable) to 0.10°F (adjustable) each minute that the unit is in operation.
- If the space temperature is more than 0.75°F below the space temperature setpoint whether the space temperature is decreasing, increase the supply air temperature setpoint that controls the cooling coil control valve by 0.08°F (adjustable) each minute that the unit is in operation, in addition to the reset described above. A maximum supply air temperature setpoint of 72°F shall be utilized.
- The supply air temperature setpoint shall be started when the AHU starts based on a proportional reset: if the space temperature offset from setpoint is between -2°F and +2°F, start the AHU with the supply air temperature setpoint between 72°F and 55°F. Run with this set-point for a 10 minute period, then release the setpoint to the automatic reset routines.

> MECHANICAL > ZONES 1-4 & 7

SUPPLY AIR STATIC PRESSURE SETPOINT RESET SEQUENCE

- If the space temperature is between -0.5°F below the space temperature setpoint and 3.5°F above the space temperature setpoint, and the space temperature is increasing, proportionally increase the supply fan static pressure setpoint that controls the variable speed drive for the supply fan by 0.01 inches WC (adjustable) to 0.125 inches WC (adjust-able) each minute that the unit is in operation.
- If the space temperature is more than 1.25°F above the space temperature setpoint whether the space temperature is increasing, increase the supply fan static pressure setpoint that controls the variable speed drive for the supply fan by 0.08 inches WC (adjust-able) each minute that the unit is in operation, in addition to the reset described above. A maximum supply air static pressure setpoint of 1.50 inches WC, as measured at 10' from the discharge of the AHU shall be utilized.
- If the space temperature is between $+1.5^{\circ}\text{F}$ above the space temperature setpoint and -3.5°F below the space temperature setpoint, and the space temperature is decreasing, decrease the supply fan static pressure setpoint that controls the variable speed drive for the supply fan by 0.005 inches WC (adjustable) to 0.025 inches WC (adjustable) each minute that the unit is in operation.
- If the space temperature is more than -0.75°F below the space temperature setpoint whether or not the space temperature is decreasing, decrease the supply fan static pressure setpoint that controls the variable speed drive for the supply fan by 0.008 inches WC (adjust-able) each minute that the unit is in operation, in addition to the reset described above. A minimum supply air static pressure setpoint of 0.45 inches WC, as measured at 10' from the discharge of the AHU shall be utilized.
- If the heating system is enabled, set the static pressure setpoint to 1.5" WC and disable the static pressure resets. At fan startup, the initial static pressure setpoint shall be 1.5" WC. The resets shall be enabled once the fan has been enabled without the heating system being enabled for 10 minutes.

> MECHANICAL > ZONES 1-4 & 7

DESIGN SUBMITTALS

TENANT SHALL SUBMIT TO LANDLORD THE FOLLOWING:

DESIGN CALCULATION SHOWING:

- Peak cooling load, and cooling load at 60°F ambient with full occupancy and equipment loads.
- Peak heating load
- Instantaneous cooling load for each space served by an individual terminal unit if more than one is required.
- Circulated CFM required for peak cooling load, using 55°F supply air temperature and a 63°F supply air temperature.
- Instantaneous heating load for each heated space.
- Toilet room exhaust air calculation, including static pressure.
- Static pressures on the low pressure duct system connected to the VAV terminal.
- Exhaust quantities and static pressure for kitchen for kitchen exhaust.
- Tenant VAV system shall be designed to provide no less than 1.75 CFM per demised S.F.

HEATING COIL DATA SHOWING:

- Make, type and capacity.
- Coil width, length and power requirements and number of circuits.
- CFM handled by coil and coil face velocity (ft/min).
- Entering and leaving air temperatures. BTU provided by air.
- Air pressure drop through coils (inches of water).

COOLING COIL SHOWING:

- Make, type and capacity.
- Make, type and cooling capacity, blow-thru or draw-thru.
- Header width, length and number of circuits.
- CFM handled by coil and coil face velocity (ft/min).
- Entering and leaving air dry and wet bulb, dew point and entering and leaving water temperatures and total heat of entering and leaving air. GPM of water used and coil water velocity (ft/min).
- Water pressure drop through coil (ft. of water).
- Air pressure drop through coil (WG – inches of water).
- Water pressure drop through the cooling system from the POC's at the entry to the demised space, through all of the Tenant equipment and back to the POC.
- Coil thickness
- Fin thickness

SUPPLY FAN DATA:

- Make, type.
- Air delivery. CFM using 63°F supply air temperature and CFM using 55°F supply air temperature, and CFM per square foot of demised space at these two conditions.
- Static pressure developed, static pressure required with 1" pressure drop across a dirty air filter bank.
- Motor RPM and HP using 63°F supply air temperature and motor RPM and HP using 55°F supply air temperature. Fan RPM at these two conditions:
- Type, size and capacity of air filters.
- Voltage, Amps, KW.

UNIT HEATER DATA:

- Make, type and size (motor HP and RPM for unit heaters).
- BTU/Hr. rating.
- Entering and leaving air temperatures CFM circulated.
- Voltage, Amps, kW per stage and total kW.

HVAC MONITOR DATA:

- Monitoring points shall be made available to the Landlord system for the purposes of improving overall system energy efficiency and also tenant comfort. These points shall be BacNet compatible controls available from each cooling or heating unit to connect to the Landlord system:
- Supply air temperature setpoint.
- Actual supply air temperature
- Chilled water valve position command (0% to 100%)
- Static pressure setpoint
- Actual supply air static pressure
- Thermostat setpoint (for each thermostat)
- Actual temperature at each thermostat
- Return air temperature
- Mixed air temperature
- Supply fan kW (from Variable Speed Drive or kW transducer)
- Return/Relief/Exhaust fan kW (from Variable Speed Drive or kW transducer)
- AHU status (on-off)
- Supply fan speed
- Return/relief/exhaust fan speed
- Unit heater status (on-off)
- Smoke Detector Monitor Input
- Unit heater total kW draw (analog signal)

> MECHANICAL > ZONES 1-4 & 7

FAN COIL UNIT SPECIFICATIONS & REQUIREMENTS

- Tenant must replace existing fan coil units serving their space with new if existing units are over 10 years old. All new fan coil units must be either Carrier 39L or Trane (LPC or MCC) series units.
- If existing fan coil unit is less than 10 years old, the unit must be completely refurbished by the Landlord's approved Mechanical Contractor at the Tenant's expense. Contact Tim Penatzer at WEBowers at 571-383-7657 for pricing.
- All fan coil units within the Tenant's space must have a secondary drain pan installed underneath each unit.
- All fan coil units must have a strainer and circuit setter installed at each unit with a pressure / temperature plug installed on the inlet and outlet of the system, as well as across the strainer. The strainer must have a ball type isolation valve installed at the drain port for service.
- All fan coil units must have an automatic air vent installed with the discharge piped to the condensate drain. A ball type isolation valve must be installed between the air vent and chilled water line. Air vents must be installed at the highest point of the supply waterline.
- Each fan coil unit must have isolation valves installed on both the supply and return chilled water lines. A ball type isolation valve must be used.
- Chilled water lines to each fan coil unit must be insulated with fiberglass insulation.
- All fan coil units must have disposable 2" pleated air filters. All units must accommodate one or more of the following filter sizes in any combination: (16x20x2, 16x25x2, 20x20x2, 20x25x2). MERV 8 or better.
- Fan coil units are not allowed to share taps off of the main chilled water loop.
- Each fan coil unit must have a dedicated tap off of the mall's main loop. All new taps must be performed by the Landlord's required Mechanical Contractor, at the Tenant's expense. Contact Dave Mure with Mechanical Air Design at 480-483-9622 for this pricing.
- The fan coil unit must not have anything attached to it, nor within two feet around each unit. This includes all conduits and piping of any kind that is not directly for the unit. The unit must not be up against any walls or other structural members that would not allow for the minimum 2' - 0" of clearance around the entire unit.
- All condensate drain lines must use copper piping. PVC piping will not be allowed. A union type fitting must be installed in the condensate drain line within 18" of the fan coil unit. All condensate drain lines should be piped to a floor sink within the Tenant's space, if possible. The drain line must be insulated with fiberglass insulation. Condensate pumps are not allowed.
- Condensate drains on draw-through units must have a p-trap equal to the negative static pressure plus one inch. Condensate drains on blow-through units must have a p-trap equal to the fan total static pressure.
- Chilled water valve must be purchased through the Landlord's required controls contractor and installed by the Tenant's mechanical contractor. Chilled water valve must be two-way only.

- Provide a harmonics filter for fan coil units with ECM motors
- Provide a harmonics filter for fan coil units with SCR electric heaters.

VARIABLE AIR VOLUME BOXES (PHASE II ONLY)

- All new VAV boxes shall be Titus brand.
- Fan powered parallel boxes with electric heating to be installed.
- No serial flow boxes are allowed.
- All new VAV boxes must be installed and ducted back to the Landlord's main trunk line by the Landlord's required mechanical contractor, at the Tenant's expense.
- The maximum pressure drop after the VAV box shall not exceed .25" Duct penetrations at the Landlord's main trunk line must not exceed the size of the inlet at the VAV box by more than one nominal size.
- Maintain at least 3 duct diameters of straight ductwork prior to the inlet of the VAV box.

HVAC CALCULATION CRITERIA

- All calculations shall be in accordance with all the latest edition of the ASHRAE Fundamentals Guide and Data Book applicable codes and requirements and good engineering practice. All Calculations shall be certified by a registered professional engineer and submitted for Landlord's engineers' approval with final working drawings.
- Provide, at minimum, code required outside air based on the occupancy when developing the heating and cooling calculations.

HEATING LOAD:

- Space shall be calculated to maintain the minimum space temperatures indicated with the equipment for day heating loads. However, no credit may be taken for lighting and people. Landlord does not provide heating. Landlord VAV system provides cooling only.

COOLING LOAD:

- Cooling load calculations (lights and occupants) shall consider all interior producing items, not to exceed 40.0 BTU per hour per square foot (300 SF/TON) of the Demised Premises. Cooling loads in excess of this amount shall be cooled by separate Tenant provided DX split systems, powered from the Tenant electric panel.

HEATING ENERGY SUPPLY:

- Heating energy supply will be electric, and Tenant will make available from Tenant's electric service. Tenant will provide unit heating as required to condition the space.

> MECHANICAL > ZONE 6 VAV SYSTEMS

Tenants in ZONE 6 with VAV systems shall adhere to the following design and operations requirements:

DESIGN CONDITIONS

HEATING:

- Inside dry bulb temperature: Sales 72°F; Storage 70°F.
- Outside dry bulb temperature: 10°F.
- Average wind velocity: 7 mph
- When the space is not occupied, minimum temperature shall at no time go below 55°F and only recirculated air may be used.

COOLING:

- Inside dry bulb temperature: 72°F.
- Relative humidity (maximum): 50%.
- Outside dry bulb: 93°F.
- Outside wet bulb: 78°F.

LOAD FACTORS:

- Roof U-Value: 0.084.
- Wall U-Value: 0.300.
- Lighting Density- per Lease Outline Drawing (maximum 3.0 watts per square foot of sales floor or customer accessible areas unless approved by Landlord, maximum of 1.5 watts per square foot for back of house operations). Cooling loads associated with lighting densities greater than 3.0 watts per square foot and 1.5 watts per square foot shall be cooled by separate Tenant provided DX split systems, powered from the Tenant electric panel.
- Population Density- code required occupancy based on space type shall be used when developing the cooling calculations. Sensible heat shall be based on 315 BTUH/person. Latent heat shall be based on 325 BTUH/person.

EQUIPMENT CONTROLS

All HVAC energy management controls shall be purchased through and installed by Landlord's required controls contractor at Tenant's expense. Tenant shall contract directly with Landlord's required controls contractor to install a fully functional direct digital control (DDC) system that must be interfaced into the Landlord's building automation system (BAS). These controls shall provide the following data at a minimum:

- Space temperature
- Supply air temperature
- Parallel fan status
- CFM
- Occupied Setpoint
- Unoccupied Setpoint
- CFM setpoint

Tenant shall purchase a new chilled water valve from Landlord's control contractor at Tenant's expense. Automated chilled water valves are to be installed by Tenant's mechanical contractor and wired by Landlord's control contractor at Tenant's expense. Tenant is not allowed access to the Landlord's BAS. If a Tenant desires to monitor space conditions, then Tenant can install, at their expense a stand-alone BAS to monitor conditions within their space if desired. Any stand-alone monitoring system shall not be attached to the Landlord's BAS in any way.

Tenant shall contract directly with the Landlord's required controls contractor to remove all DDC components and disconnect all network cabling before demolition.

Tenant's General Contractor shall be held responsible to maintain the integrity of the BAS network cable within their space during all phases of construction. General Contractor shall bear sole responsibility for any damage or disruption to the BAS network.

All new tenant HVAC and lighting controls must meet the following specifications:

- Open protocol, BACnet, based communications backbone.
- New controllers must be natively tied into existing Tridium Niagara based BMCS.
- Macerich Preferred controllers are BACnet Testing Laboratories (BTL approved and meet all requirements for BACnet advanced application controllers (B-AAC).

> MECHANICAL > ZONE 6 VAV SYSTEMS

COOLING MEDIA:

- The owner will be providing cooled supply air to the Tenant spaces. Landlord VAV system is designed to provide 58-60°F supply air temperature.
- If Tenant uses cooling air from the Landlord VAV system, it shall be made available during normal mall “business hours”.
- Minimum working pressure of all Tenants’ ductwork, equipment and VAV boxes will be 4” Water Gauge (WG).
- Maximum allowable pressure drop through all Tenant’s air distribution systems and VAV boxes (measured at connecting point to main ductwork) shall be one inch (1”) Water Gauge (WG). This means that the VAV box will need to be sized to deliver the required design air flow at 58-60°F dry bulb temperature at approximately 0.5” WG, if the remainder of the Tenant ductwork system has a pressure drop of 0.5” WG.

VENTILATION SYSTEM DESIGNS:

- All Tenant HVAC systems must utilize electronic controls with BACNET controls/ compatibility. No pneumatic controls are permitted. Tenant control systems are local to the Tenant premise only. No connection to Mall control system is required.
- Minimum outside air supply shall be based on the code mandated OSA CFM, plus any additional requirements to maintain air supply equal to total air exhausted. This shall not exceed twenty percent (20%) of total air volume supplied.

SEQUENCE OF CONTROL OPERATION

Relay activated by outdoor thermostat.

Occupied mode Cooling :

VAV damper with modulate to maintain the max/min design CFM based on space temperature demand.

Occupied mode Heating:

Inlet air will be set to minimum and parallel fan will start followed by electric heat stages to maintain space temperature.

Unoccupied mode :

Parallel fan with start and cycle heat to maintain unoccupied heat set point.

INTERLOCKS:

- Interlock will keep electric coil(s) de-energized whenever respective unit heater is not running.
- Whenever electric coil is de-energized, controller shall return to “off” position. Coil shall always start unloaded.
- The exhaust fan must be interlocked with the light switches for the store customer service area.
- The combined HVAC and exhaust system must be in operation during all hours that the Tenant is open for business.

SUBMITTALS

Tenant shall submit the following information where applicable, for approval and acceptance in writing, before ordering any work to commence:

- Peak cooling load.
- Peak heating load.
- Instantaneous cooling load for each space served by an individual VAV Box if more than one is required.
- Instantaneous heating load for each heated space.
- Toilet room exhaust air calculation, including static pressure.
- Exhaust quantities and static pressure for kitchen exhaust
- Landlord VAV system designed to provide 58°F supply air temperature on peak cooling days.
- Unit Heater Data:
 - Make, type and size (motor HP and RPM for unit heaters).
 - BTU/Hr. rating.
 - Entering and leaving air temperatures, CFM circulated.
 - Voltage.
 - kW rating per stage of heating
- Temperature Control System Data:
 - Make and control diagram and description

The [ADDENDUM](#) includes several Exhibits related to HVAC criteria.

> STRUCTURAL / EXIT CORRIDORS

STRUCTURAL

The following criteria is provided for the purpose of designing the Tenant's structural drawings. This criteria is provided as a guideline for Tenant's Engineer. It is the Tenant's responsibility to verify existing conditions and comply with all applicable codes and standards.

Complete Engineered drawings must be submitted to the Landlord's Tenant Coordinator for review and approval. Landlord will review the plans for conformance to basic Mall requirements. The Landlord does not review for design, nor does the Landlord accept responsibility for the Tenant's adherence to governing codes.

The documents to be submitted for Landlord approval must include complete plans and specifications for all structural work. Documents must be signed and sealed by a Licensed Engineer in the state where the Shopping Center is located.

The [ADDENDUM](#) includes several Exhibits related to structural certifications and work at the Center. The specifications and details in these exhibits must be followed during design and construction:

EXHIBIT 1a. Structural Certification for Zones 1 and 3

EXHIBIT 1b. Structural Certification for Zones 2 and 4

EXHIBIT 5. Typical Roof Penetration Detail

EXHIBIT 6. Typical Slab on Grade Detail

EXHIBIT 7. Floor Penetration Detail

EXHIBIT 8. Typical Joist Reinforcement Detail

I. GENERAL REQUIREMENTS

- The Tenant's storefront must be structurally self-supported. Tenant may not support the storefront from the bulkhead or fascia. Structural support for Tenant storefronts must be from the roof joists for lateral bracing.
- Fixtures and equipment may not be attached to or supported from the floor or roof deck.
- Structural drawings are required for all items that require support from the steel structure or for all roof top equipment weighing 300 lbs. or more.
- Joist reinforcing is required for roof top equipment as well as steel support for all roof openings. Details of joist reinforcing are to be included in the Tenant plans submitted for Landlord review. Upper level Tenant's must review base building structural drawings prior to installing a security safe, ovens or any equipment weighing 300 lbs. or more.

EXIT CORRIDORS

Distribution of utilities through a newly constructed or an altered exit passageway is prohibited except for equipment and ductwork specifically serving the exit passageway, sprinkler piping, standpipes, electrical raceway for fire department communication and electrical raceway serving the exit passageway.

FOOD CRITERIA CONTENT OVERVIEW

2.1

FOOD COURT

DETAILS SPECIFIC DESIGN, SIGNAGE, AND TECHNICAL REQUIREMENTS FOR FOOD COURT TENANTS.

2.2

INLINE COUNTER SERVICE

DETAILS SPECIFIC DESIGN, SIGNAGE, AND TECHNICAL REQUIREMENTS FOR FOOD TENANTS WITH COMMON AREA FACING COUNTER SERVICE AND LIMITED TO NO SEATING.

2.3

RESTAURANTS

DETAILS SPECIFIC DESIGN, SIGNAGE, AND TECHNICAL REQUIREMENTS FOR FOOD TENANTS WITH INTERIOR OR EXTERIOR FACING RESTAURANT SERVICE.

SECTIONS OF INTEREST

INLINE CRITERIA

Standard design, technical, and sign requirements in addition to the contents in this section.

DESIGN INSPIRATION

Provides design inspirations for visual aesthetics.

BUILDING DETAILS

Includes property reference photos and specific Storefront design details.

PROPERTY INFO

Includes information on the Property's building codes, area permitting, and required contractors.

SUBMITTALS

Outlines requirements on how and what to compile for submittals to the Landlord for design reviews.

This Food Tenant Criteria is specifically tailored to highlight unique technical and design requirements for Tenant's cooking, preparing, and selling food products.

Through the application of the Criteria guidelines, Food Tenants will produce distinctly original designs unique to their brand and the Center. These guidelines are to help maintain a consistent design quality while still allowing each Tenant to achieve a high level of expression and diversity.

The goal is to enhance the shopping experience for our Customer through the quality and artfulness of Tenant design.

This Criteria will often point to the [INLINE RETAIL CRITERIA](#), as several requirements and design concepts are shared.

The Tenant's Architect is encouraged to contact the Landlord's Tenant Coordinator to discuss any specific design intentions prior to commencing design work. The Tenant Coordinator will strive to resolve all outstanding design issues. However, the Tenant Coordinator may, in the best interest of the Center, reject any aspect of the Tenant's design.

If an acceptable design cannot be agreed upon, the Landlord may, at the Tenant's expense, provide an additional concept Storefront design for consideration.



> CONTENTS

- FOOD COURT ZONE PLAN**
- DESIGN**
 - STOREFRONT*
 - FOOD DISPLAY & PREP / SEATING / QUEUING*
 - LAYOUT / SERVICE COUNTER DESIGN*
 - STOREFRONT & COUNTER MATERIALS / COUNTER ELEMENTS*
 - LIGHTING*
 - STOREFRONT CEILING / ROLLING GRILLE / NEUTRAL PIERS & DEMISING WALLS*
 - INTERIOR & PREP AREAS*
- SIGNAGE**
 - STOREFRONT*
 - MENU BOARD*
- TECHNICAL**

SECTIONS OF INTEREST

- DESIGN INSPIRATION**
Provides design inspirations for visual aesthetics.
- PROPERTY INFO**
Includes information on the Property's building codes, area permitting, and required contractors.
- SUBMITTALS**
Outlines requirements on how and what to compile for submittals to the Landlord for design reviews.

The Food Court Criteria provides key technical information and design requirements to ensure your food service enlivens the consumer experience and interfaces with the Center's food court design.

The Tenant and the Tenant's architect assume the following important obligations:

- Fulfill the intent of the Criteria both in concept and in detail.
- Determine and respond to the actual physical conditions of the Tenant's location.
- Maintain and enhance the high standards of quality established in the construction of the Center.
- Ensure the quality of execution of all design material, finish, and detail concepts in the construction of the Tenant's improvement.
- Provide the required detail at all transitions from Tenant Storefront to neighboring Storefronts, as well as to the base building.



> ZONE PLAN

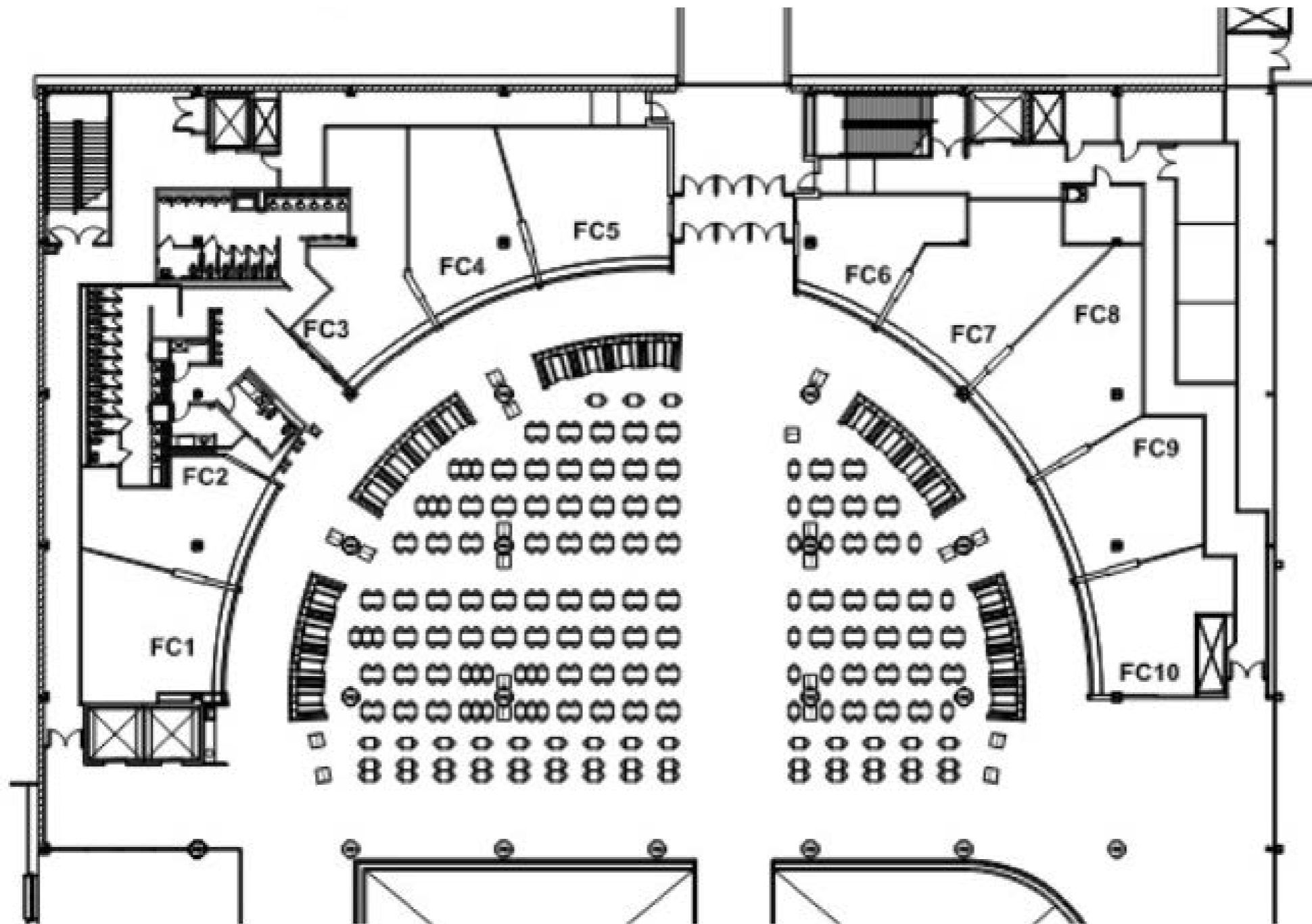

> ZONE DESIGN



Following the design criteria outlined in this section, Food Court Tenants must incorporate the below scope of work into their design and construction:

- Remove the overhead ceiling element and the tube steel support frame (non-building structural); allowing finishes to extend up to the mall ceiling.
- Install new glass with an opaque panel at existing opening along the demising wall. New glass panel can be utilized for logo or signage, refer to rendering on this page.
- Install own finishes and material along the neutral wall.

> DESIGN > STOREFRONT

OVERVIEW

Food Courts may include a variety of spaces that are comfortable and stylish, inviting the Customer to come, stay, eat, and enjoy.

The design of each unit, as viewed from the common area, must convey the unique character and sense of identity for each Tenant and also be compatible with the overall Architectural design of the Food Court.

The storefront design area considers all portions of the store that are visible to the public, in front of the full height service area partition.

Unique and unexpected storefront design will spark interest for to draw in Customers.

Encouraged storefront design traits include:

- Use of contrast:
 - Mixing modern and traditional design elements.
 - Mixing neutrals with colors.
 - Blending shiny and matte surfaces.
- Combining patterns with solids.
- Embracing unique craft and technology.
- Using special features, tasteful props, and displays.



> DESIGN > FOOD DISPLAY & PREPARATION / SEATING / QUEUING

FOOD DISPLAY

Showcases must reinforce the Tenant's image and be an integral part of the design within the counter.

Glass must be tempered or a safety type. Plexiglas is not permitted.

Showcases shall not exceed 14" above counter and 36" overall width. It shall not be more than 50% of the counter length and located no closer than 48" from the neutral pier.

FOOD PREPARATION AS THEATRE

When food preparation is visible to the public, the area is required to be designed with a sense of theater.

The need for an authentic, shared, and unique experience has grown over time. Unique experiences are the opposite of one-size-fits-all approach of the "chain". Tenants that offer a peek into the making of what they sell help include the customer and make for an authentic experience.

SEATING

- Tenants shall typically not provide, place, or install any seating, carts, etc. inside or outside the lease premises.
- Select specific areas may include private and bistro style seating. These options are site specific, so discussing early with Leasing and Tenant Coordination is recommended. Design Approval is required for all common area Tenant seating.

QUEUE AREAS

- All food venues must provide a queue layout that allows for the mall circulation to maintain its code minimum distances for general circulation.
- Stanchions are not allowed. Other indicator for customer directional flow will be considered.



> DESIGN > LAYOUT / SERVICE COUNTER DESIGN

LAYOUT

Due to the high visibility of the Customer Service Area, particular attention is given to the design review of this area. Service areas, furnishings, display cookery, food prep and cooking areas visible from the mall common area must meet strict design standards.

- Support rooms and storage shall be concealed from public view.
- A full-height partition wall must separate the Customer Service Area and Prep Area.
- Access to the Prep Area shall be via a self-closing door or between staggered “blind walls”.
- Pass-thru windows with any customer views into kitchen zone are not allowed.
- Landlord may require that any storefront setback area shall have flooring compatible in quality, color and pattern to the mall flooring material.
- All Tenant construction shall be self-supporting from the floor and structurally independent of the mall fascia and bulkhead structure. Tenant Construction may be braced horizontally/laterally to the overhead structure (not to the roof deck) within the Tenant space as depicted on Tenant plans and approved by the Landlord.

FRONT SERVICE COUNTER DESIGN

- The vertical counter face cannot be on one plane. Design must include areas that pop in and pop out to create movement. This can be achieved by recessing a small portion of the counter face by a few inches or can be more dramatic. This can also be achieved by ranging counter heights and taller vertical elements. Taller vertical elements must not block visibility.
- Counter face cannot be all one material. Must incorporate a minimum of two to three different types of material that coordinate well together.
- Vertical elements can include a plasma screen menu board or can have additional vertical signage.
- Tenant to specify a protective edge at the bottom of the counter.
- The form and materials used for counters shall be designed to be inviting to the public to help lure them to the space.
- The toe kick material must be a minimum of 3” behind the face of the counter.
- All Tenant build out must be contained within the lease line unless specifically noted in this criteria.
- Counter tops must be “Corian” or similar solid surface materials, metal or stone. Tenant counter and counter tops are to be custom designed and fabricated. Plastic laminate is prohibited.
- Plastic laminated countertops are prohibited.
- Maximum counter height is 3’-6”. Counter design, including heights, must comply with all accessibility guidelines enforced by national or local jurisdictions and the Americans with Disabilities Act.
- Sneeze guards shall be used above the front counters as required.

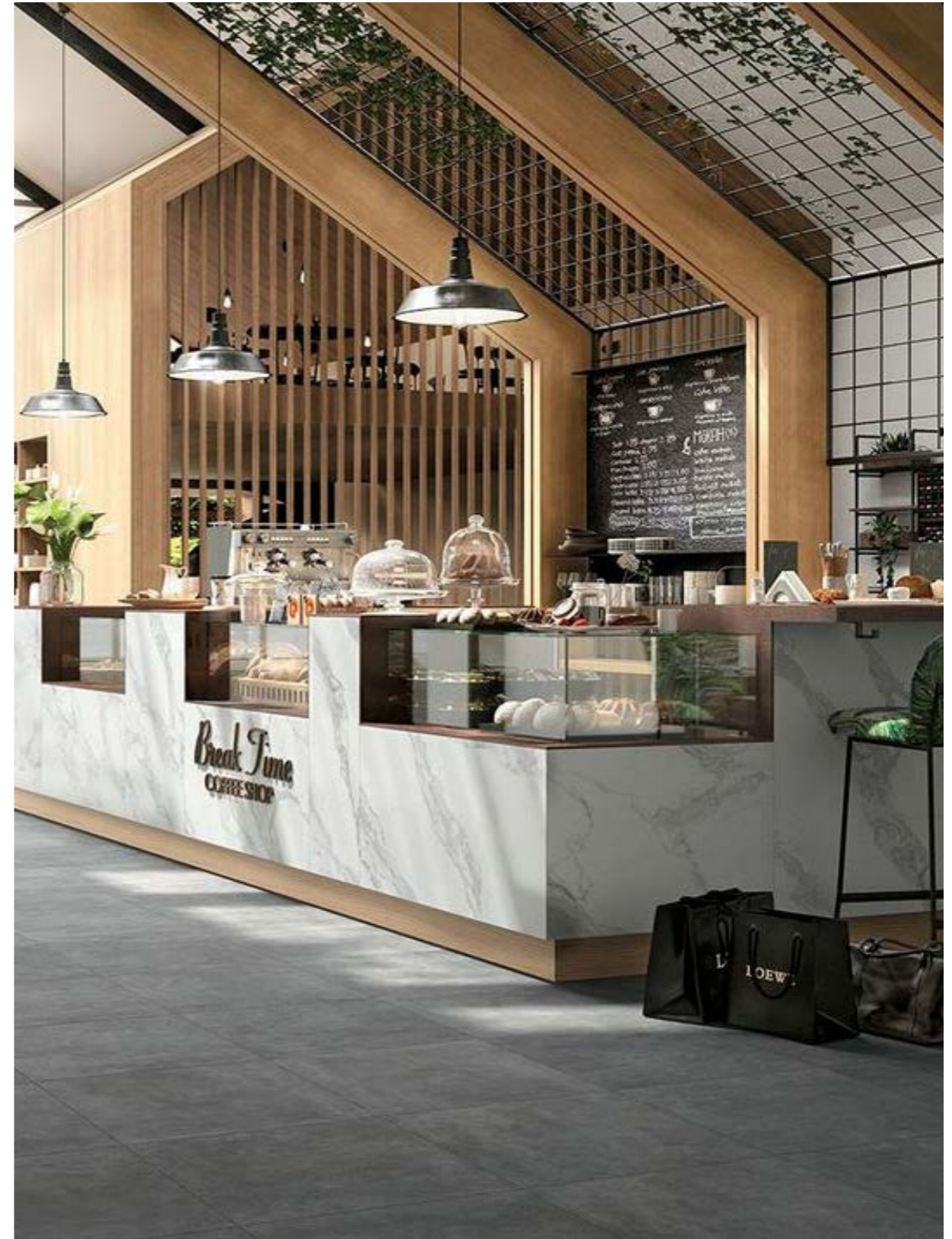

> DESIGN > STOREFRONT & COUNTER MATERIALS / COUNTER ELEMENTS

FRONT SERVICE COUNTER AND STOREFRONT MATERIALS

All finish materials must be backed by a minimum 5/8" solid surface material and may include the following:

- Counter tops must be solid surface materials, metal or stone. Tenant counter and counter tops are to be custom designed and fabricated.
- All stone/tile colors must be integral throughout.
- Metal panels and architectural hardware shall have a professional and durable finish.
- Color anodized, baked painted or antique finish
- Wood veneers and weathered or distressed wood (submit specification for approval)
- Resin panels such as 3-Form products
- Back-painted tempered glass panels
- Glass tiles

Finish materials shall NOT include the following materials:

- 4"x4", 6"x6", 12"x12" glazed tiles
- Shingles or boards
- Plastic laminate
- Faux or plastic formed brick, block or stone
- Clear anodized aluminum
- Other materials as deemed unacceptable by Landlord

COUNTERTOP ELEMENTS

- Cash registers must be recessed so that they extend no more than 9" above the counter top.
- Condiment and utensil displays or dispensers must be fully recessed into the counter.
- Fully-recessed counter-top trash receptacles (for straw wrappers, etc.) must be provided near the condiment and utensil displays.
- Tray rails, if used shall be integrated into the counter design, be contained within the lease line.
- Drink dispenser and other utilitarian kitchen equipment may not be placed on the front counter.



> DESIGN > LIGHTING

LIGHTING

Tenants must light both their storefront as well as the countertop.

Lighting on architectural elements and menu boards are also required.

- Tenant is responsible for all lighting within the entire demised premises.
- Foot-candle levels at counter height shall be 50 FC average maintained.
- The use of decorative lighting such as luminous ceilings, chandeliers, pendant, wall units or clear type glitter strips are permitted if the location is approved by Landlord.
- No lighting shall be installed outside the demised premises.
- All Tenant lighting shall be controlled separately, and illuminated during mall hours.
- To retain and protect the visual environment of the area and for the benefit of all Tenants, each individual Tenant shall limit the brightness of their lighting fixtures, which shall be subject to the Tenant Coordinator's approval.
- Emergency lighting must be fully recessed in the front-of house, (sales) areas. No surface mount type is allowed.
- No track lighting is permitted in the front of house area unless specifically approved by Landlord. It can be used if it is hidden or recessed into ceiling, otherwise Tenant should use mono-point type fixtures.
- Use of high quality fixtures is required. Submit cut sheets of fixtures including manufacturer, model and any photos of specific fixture to Landlord for design approval.
- Use staggered under counter lighting for an even distribution of light.
- Vertical storefront surfaces must be lit.
- Bottom of pendant light to be at 6'-8" minimum, a.f.f. installed

Recommended lighting approaches include but are not limited to:

- Pendant fixtures that are suspended by cord, cables or chain with uplight and/or downlight components.
- Recessed downlights
- Surface mounted high-tech, high quality, low profile and decorative fixtures
- Indirect ceiling cove lighting system using linear lamps.

Unacceptable lighting approaches include but are not limited to:

- H.I.D. lighting unless approved by the Architect and the shielding is specified in submittal.
- Direct visual exposure of incandescent lamps and/or fluorescent tubes.
- Acrylic or plastic lensed fixtures, or bare lamps
- Fluorescent fixtures
- Track light fixtures
- Strobe moving or fiber optic lights
- Floor-mounted fixtures
- Incandescent fixtures

To create a consistent theme of lighting and appetizing color, lamp or "bulb" requirements must be adhered to as follows:

- No linear T-5, T-8 or T-12 fluorescent lamps are allowed, unless specifically installed in a ceiling cove where the lamp is not visible.



> DESIGN > STOREFRONT CEILING / GRILLE / NEUTRAL PIERS & WALLS

STOREFRONT CEILING

- Suspended ceiling of gypsum board, (hard lid), is required in customer areas.
- Tenant must provide a reflected ceiling plan indicating any and all Tenant lighting, suspended design elements and signage for Landlord approval.
- Ceiling access panels, where required must be depicted on the Tenant's plans, approved by Landlord and be provided at Tenant's expense.
- Allow for access to all structural mechanical, plumbing, electrical, telephone and fire protection systems including all junction boxes, switches, valves, etc. and other equipment for purposes of servicing, and maintaining this infrastructure.

ROLLING GRILLES

Rolling grilles are not allowed.

NEUTRAL PIERS AND DEMISING WALLS

The Customer Service Area shall address the full opening width, abutting the Neutral Walls and Neutral Knee Walls on each side of the leased space and extending full height to the Mall soffit.

- Mall structural columns, excluding those treated as neutral piers, located either within the Storefront Zone or along the store frontage, must be integrated into the store design unless otherwise directed by Landlord.
- Special condition neutral walls may be low and extend back from the face of the lease line. This condition increases visibility into the store, however, it requires close coordination with the Tenant Coordinator in the design process.



> DESIGN > INTERIOR AND PREP AREA

Kitchen areas, storage, dish areas, and any other areas not visible to the public must meet the following design requirements:

LIGHTING

Lighting may include, but is not limited to:

- 2'x4' lay-in surface-mounted fluorescent light fixtures.
- Any fixture allowed by code necessary for food preparation.

FLOORING

The entire Lease Premises shall be completely and properly sealed using a 'Dex-o-tex' NEOBOND II Fracture Resistant Membrane Waterproofing or equal membrane type sealer approved by Landlord, prior to the installation of any finished flooring material.

The membrane must be turned up all perimeter storefront walls, counters and surfaces a minimum of 24", to protect the adjacent Tenants and Mall common areas. Then, either FRP (prep area only), or tile is to be installed up to at least 4'.

Tenant to submit detail to Landlord for approval prior to installation.

Tenant shall furnish and install floor tile over waterproof membrane throughout the entire premises.

The finished floor must be sloped to the Tenant installed floor drains.

Allowed flooring materials include:

- Quarry tile
- Porcelain ceramic tile

Prohibited flooring materials include:

- Vinyl
- Glazed ceramic tile
- Carpet
- Any other material deemed unsuitable by the Landlord

CEILING

2'x4' drop-in panels with an approved finish shall be permitted in storage areas so long as they are not visible to the customers.

WALLS

All walls in the Prep Area must be of a durable, non-porous, washable surface as required by health codes.

EXIT DOORS

All exit door specifications, hardware, door handles, recess dimensions, etc. shall be per Landlord criteria and conform to local codes and ordinances.



> SIGNAGE > STOREFRONT

Food Court Tenant's primary storefront sign must be creative, imaginative and incorporated into the overall storefront design.

DESIGN REQUIREMENTS

Design requirements include:

- Sign must be proportional to overall elevation. Landlord will review sign size on an individual basis. Sign length must not be more than 1/3 of the overall storefront length.
- Sign must complement overall design and add visual interest.
- Power must be concealed.
- 12" max letter height will be enforced.
- Back of sign must be finished.
- Tenant's storefront sign shall use reverse channel letters fabricated of painted stainless steel or aluminum, without exposed mechanical fasteners or fabricator identification tags.
- Signs shall not utilize prefabricated edging materials such as "Jewelite" and sintra (expanded PVC).
- Return edges on channel letters must be a minimum of 1-1/2" and a maximum of 4". All channel letters are to be stem mounted 2" of the sign board. Illumination to each letter should be 3500K warm white neon.
- All stems are to be finished to match adjacent surface sign board.
- All wiring, shields, and insulators, are to be hidden on the front and the sides by the sign board. All transformers are to be remotely located and may not be visible to the public. Signs are to be wired to the Tenant's panels, by Tenant.
- Tenant signs graphics will be limited to trade name and nationally recognized logo only. No so-called "tag-lines" will be allowed on Tenant's sign. The graphic may be of any font style. All graphics must be centered on the sign board. Tenant sign graphics may not extend outside of the designated sign area.
- Only one sign per Tenant is allowed.

PROHIBITED ELEMENTS

The following types of signs, sign components and devices shall not be permitted:

- Any sign, advertisement, notice stickers, decals or lettering other than the Tenant's name or graphic logo exhibited, inscribed, painted or affixed on any part of the storefront counter.
- Cloth, Styrofoam, cardboard, or paper signs.
- Handwritten signs except chalkboards used as menu boards.
- Visual or audio animated signs.
- Exposed neon crossovers or raceways.

CONSTRUCTION REQUIREMENTS

Construction/Installation requirements include:

- The Tenant is responsible for all signs, permits, power sources, connections and installations.
- All raceways, transformers, ballasts, PK housing, conduit boxes, electrode boxes and other wiring shall be concealed from public view.
- Exposed crossovers between letters or words are not permitted.
- Metal sign materials, fastenings and clips of all types shall be hot-dipped galvanized iron, stainless steel or brass. Black iron materials of any type are not permitted.
- Labels on exposed sign surfaces are not permitted except those required by local ordinances. Any required labels must be inconspicuous.
- All electrical sign components must be U.L. labeled.



> SIGNAGE > MENU BOARDS

Menu board applications must be a part of the overall store design. We strongly encourage using a graphic designer to create your boards.

DESIGN REQUIREMENTS

The following requirements must be when designing your menu boards:

- All menu boards must be submitted to the Landlord for review and approval prior to start of Tenant construction.
- Professional quality drawings/renderings must be submitted for approval.
- Design shall be an integral part of the graphics and complimentary to primary signage character.
- Overall width of menu board cannot exceed 60% of overall storefront width.
- Mounting height to be a minimum of 7'-0" to bottom of sign with maximum height of 10'-0" and held a minimum of 10" from edge of walls.
- The menu board must be non-reflective to avoid glare.

PERMITTED ELEMENTS

Permitted menu board design elements include:

- Artisan type quality such as chalkboards, painted wood or unusual materials and combinations of material.
- Frames, holders, text, photo displays, lighting and materials must be creatively designed.
- High quality digital print outs for menu board may be approved at Landlord's discretion.
 - Photographs used in menu boards must be professionally produced and approved by the Landlord.
- Externally illuminated menu boards are allowed.
 - Tenant is required to submit light fixture cut sheet for approval.

PROHIBITED ELEMENTS

Not permitted menu board design elements include:

- Standard factory designs.
- Standard surface-mounted box-type internally illuminated menu boards are not permitted.



> TECHNICAL

Food Court Tenants must adhere to the technical requirements found in the [INLINE TECHNICAL CRITERIA](#).

In addition to the requirements detailed in the Technical Criteria, Tenants cooking food in their space must adhere to the following:

GENERAL REQUIREMENTS

- **KITCHEN SINKS** including pot sinks, scullery sinks, pre-wash sinks and other kitchen units must be connected to a grease trap.
- **DISHWASHERS** may not be connected to grease trap.
- **GREASE INTERCEPTOR** must be designed and approved by Landlord prior to installation, especially if located outside the lease line.
- **OIL COLLECTION AND HAULING SYSTEM** is required for Tenants with fryers or other grease/oil generating equipment that does not run through an interceptor. Landlord does not provide a centralized collection point.
- **BACKFLOW PREVENTERS** are required for food service, hair salons or other Tenants with equipment or operations that have the possibility of backflow. These must be certified and acceptable to the water district and checked yearly or as required by the local authority having jurisdiction.

KITCHEN EXHAUST REQUIREMENTS

- **LANDLORD REVIEW** is required to ensure the exhaust does not compromise the ventilation air of adjacent mall roof top units.
- **EXHAUST FAN** must be a SWSI centrifugal fan fitted with a minimum 10'-0" stainless steel upblast. Guy wires must be attached to the roof to secure the stack.
- **GREASE GUARD** containment system must be installed to protect the roof. Quarterly maintenance program is required for the grease containment system. Proof of maintenance contract must be presented to the Landlord prior to opening.
- **"SUPREME" HEAVY DUTY GBD BLOWERS** are required for all kitchen exhaust or grease laden air removal.

FUMES AND ODORS

The following constitutes the minimum requirements for special exhaust systems which Tenant must furnish and install in the Leased Premises for the elimination of fumes and odors due to Tenant operations:

- A total negative pressure of ten percent (10%) must be maintained during all hours that Tenant is operating its business in the Leased Premises.
- The HVAC system must be modified to provide additional make-up supply air to offset the quantity of air exhausted.
- The Tenant must have a certified air balancing contractor test the completed system and verify its operation according to these specifications. A copy of the air balancing report must be submitted to the Mall General Manager for review and approval prior to opening for business.
- The combined HVAC and exhaust system per the above-noted specifications must be in operation during all hours that Tenant is operating its business in the Leased Premises.
- The combined HVAC system must be connected to the Landlord EMS by the Landlord required contractor. See the Technical Criteria section for specifics.
- Indoor tenants which will be using any type of gas, liquid or solid fuel for heating, cooking or other use, must have an active carbon monoxide detector installed. The type should be and Hardwire Interconnectable 120- Volt Carbon Monoxide Alarm with Digital Display and Battery Backup.
- Carbon dioxide detection is required if tenant has a carbon dioxide systems with 100 lbs. or more of carbon dioxide used in their beverage dispensing applications.

> TECHNICAL

STRUCTURAL

The structure or sub-structure that supports any new or replacement HVAC unit, transformer, other heavy equipment or modification of any structure or substructure, shall be designed, engineered and installed at Tenant's sole cost and expense.

Tenant shall provide structural engineering calculations and drawings from a licensed structural engineer (Registered in the State of the Center where the work is located) to Landlord for review and approval prior to installation of any such items or equipment.

All equipment is to be installed over structural members that can support the weight of the equipment in areas designated by Landlord.

All recommendations of design and verification of completion shall include the structural engineer's embossed seal from the state.

ELECTRICAL

An empty, separate meter socket will be stubbed to the Tenant premises from the Mall electrical room. Tenant must install a demand check meter per Landlord specs using the Landlord required contractor. See the Technical Criteria section for specifics.

MECHANICAL

Tenants must furnish and install their own mechanical systems as required for their operation.

NATURAL GAS

Natural gas service is available for Tenants to obtain from the local gas company. Gas is permitted for cooking equipment only. Gas is not available for HVAC.

POTABLE WATER

A single water stub-in will be supplied by the Landlord from the Landlord's meter to each Tenant space. Tenant shall provide a water sub-meter that is accessible to Mall management.

SANITARY WASTE

A 4" sanitary waste line shall be stubbed below each Tenant space by Landlord. Tenant shall route their own vent lines to a point above the roof.

GREASE WASTE

Tenant must provide their own grease interceptors, within the demised premises.

FIRE PROTECTION / SPRINKLER SYSTEM

Tenants must use the Mall's required sprinkler contractor as well as connect to the Landlord's fire alarm system, using the Landlord required fire alarm contractor.

> CONTENTS

❑ DESIGN

- ❑ *PREP & FOOD DISPLAY / QUEUE / LAYOUT*
- ❑ *QUEUE / PATIOS / SEATING*
- ❑ *COUNTER DESIGN / COUNTER ELEMENTS*
- ❑ *MATERIALS / LIGHTING / FLOORING*

❑ SIGNAGE

- ❑ *PRIMARY SIGNAGE / MENU BOARDS*

❑ TECHNICAL

SECTIONS OF INTEREST

❑ *INLINE CRITERIA*

Includes standard design, technical, and sign requirements in addition to the contents in this section.

❑ *DESIGN INSPIRATION*

Provides design inspirations for visual aesthetics.

❑ *BUILDING DETAILS*

Includes property reference photos and specific storefront design details.

❑ *PROPERTY INFO*

Includes information on the Property's building codes, area permitting, and required contractors.

❑ *SUBMITTALS*

Outlines requirements on how and what to compile for submittals to the Landlord for design reviews.

The Inline Food Counter Service Criteria provides key technical information and design requirements to ensure your common area facing counter food service enlivens the consumer experience and interfaces with the Center.

This criteria will often point to the [INLINE RETAIL CRITERIA](#) as several requirements and design concepts are shared. The content in this section highlights the unique concepts for food service design.

The tenant and the tenant's architect assume the following important obligations:

- Fulfill the intent of the Criteria both in concept and in detail.
- Determine and respond to the actual physical conditions of the Tenant's location.
- Maintain and enhance the high standards of quality established in the construction of the Center.
- Ensure the quality of execution of all design material, finish, and detail concepts in the construction of the Tenant's improvement.
- Provide the required detail at all transitions from Tenant storefront to neighboring storefronts, as well as to the base building.



> DESIGN > PREP & FOOD DISPLAY / QUEUE / LAYOUT

Inline and Restaurant Food Tenants must adhere to the design requirements found in the [INLINE RETAIL DESIGN CRITERIA](#).

In addition to the requirements detailed in the Design Criteria, Tenants serving food in their space must adhere to the following design requirements:

PREPARATION AS THEATER

Tenant's offering a peek into the making of food, by nature, include the customer and make for an authentic experience. This inclusion of the customer will increase engagement and is highly encouraged.

FOOD DISPLAY

When displaying food, the following requirements must be followed:

Showcases must reinforce the Tenant's image and be an integral part of the design within the counter.

Glass must be tempered or a safety type. Plexiglas is not permitted.

Showcases shall not exceed 14" above counter and 36" overall width. It shall not be more than 50% of the counter length and located no closer than 48" from the neutral pier.

LAYOUT

Due to the high visibility of the Customer Service Area particular attention is given to the design review of this area. Service areas, furnishings, display cookery, food prep and cooking areas visible from the mall common area must meet strict design standards.

- Support rooms and storage shall be concealed from public view.
- A full-height partition wall must separate the Customer Service Area and Prep Area.
- Access to the Prep Area shall be via a self-closing door or between staggered "blind walls".



> DESIGN > QUEUE / PATIOS / SEATING

QUEUE AREAS

All food venues must provide a queue layout that allows for the Mall to maintain its code minimum distances for general circulation.

Stanchions are not allowed. Other indicators for customer directional flow will be considered.

PATIO AREAS

Exposed patios are encouraged however, they should not extend beyond the lease line. In special cases there may be opportunity to extend the patio but it must be in compliance with all common mall code, circulation requirements, and leasing agreements.

Projection or canopy may increase the visibility of the storefront over seating areas. They also help with lighting the Storefront.

- Common mall flooring must be maintained. Coordinate with Landlord design if railings or other elements will have an effect on the flooring.

SEATING

Where interior seating is needed or desired, it is suggested that the enclosure line be moved into the lease space by approximately 12 feet.

- Patio seating must be separated from the common area circulation in the Mall. A layout will be required.
- All visible furniture must be reviewed by the Landlord for suitability both aesthetically, as well as for performance specifications.
- Tenant is responsible to confirm additional requirements with the local authorities for any railing or barrier for the Tenant's proposed area.
- In some cases options for furniture may be supplied by the mall design team for the Tenant to choose from.



> DESIGN > COUNTER DESIGN / COUNTER ELEMENTS

FRONT SERVICE COUNTER DESIGN

- The form and materials used for counters shall be designed to be inviting to the public to help lure them to the space.
- Tenant to specify a protective edge at the bottom of the counter.
- Counter tops must be “Corian” or similar solid surface materials, metal or stone. Tenant counter and counter tops are to be custom designed and fabricated. Plastic laminate is prohibited.
- Plastic laminated countertops are prohibited.
- Maximum counter height is 3’-6”. Counter design, including heights, must comply with all accessibility guidelines enforced by national or local jurisdictions and the Americans with Disabilities Act.
- Sneeze guards shall be used above the front counters as required.

COUNTERTOP ELEMENTS

- Cash registers must be recessed so that they extend no more than 9” above the counter top.
- Condiment and utensil displays or dispensers must be fully recessed into the counter.
- Fully-recessed counter-top trash receptacles (for straw wrappers, etc.) must be provided near the condiment and utensil displays.
- Drink dispenser and other utilitarian kitchen equipment may not be placed on the front counter.



> DESIGN > MATERIALS / LIGHTING / FLOORING

FRONT SERVICE COUNTER AND STOREFRONT MATERIALS

All finish materials must be backed by a minimum 5/8" solid surface material and may include the following:

- Counter tops must be solid surface materials, metal or stone. Tenant counter and counter tops are to be custom designed and fabricated.
- All stone/tile colors must be integral throughout.
- Metal panels and architectural hardware shall have a professional and durable finish.
- Color anodized, baked painted or antique finish, (minimum of 3/8" thick), solid material, dents, dings or oil canning.
- Wood veneers and weathered or distressed wood (submit specification for approval)
- Resin panels such as 3-Form products
- Back-painted tempered glass panels
- Glass tiles
- Wood veneers

Finish materials shall NOT include the following materials:

- 4"x4", 6"x6", 12"x12" glazed tiles
- Shingles or boards
- Natural, polished or honed stone and/or porcelain tile, standard square tile design or glazed tiles
- Plastic laminate
- Faux or plastic formed brick, block or stone
- Clear anodized aluminum
- Other materials as deemed unacceptable by Landlord.

LIGHTING

Tenants must light both their storefront as well as the countertop. Lighting on architectural elements and menu boards are required.

FLOORING

All "wet" areas must install a waterproof membrane that is tested and confirmed by the Landlord. Full requirements can be found in the plumbing section of the [INLINE TECHNICAL CRITERIA](#).



> SIGNAGE > PRIMARY / MENU BOARDS

PRIMARY STOREFRONT SIGN

Inline and Restaurant Food Tenants must adhere to the signage requirements found in the [INLINE SIGN CRITERIA](#).

MENU BOARDS

Inline and Restaurant Food Tenants must adhere to the menu board requirements found in the [FOOD COURT SIGN CRITERIA](#).



> TECHNICAL

Inline and Restaurant Food Tenants must adhere to the technical requirements found in the [INLINE TECHNICAL CRITERIA](#).

In addition to the requirements detailed in the Technical Criteria, Tenants cooking food in their space must adhere to the following:

GENERAL REQUIREMENTS

- **KITCHEN SINKS** including pot sinks, scullery sinks, pre-wash sinks and other kitchen units must be connected to a grease trap.
- **DISHWASHERS** may not be connected to grease trap.
- **GREASE INTERCEPTOR** must be designed and approved by Landlord prior to installation, especially if located outside the lease line.
- **OIL COLLECTION AND HAULING SYSTEM** is required for Tenants with fryers or other grease/oil generating equipment that does not run through an interceptor. Landlord does not provide a centralized collection point.
- **BACKFLOW PREVENTERS** are required for food service, hair salons or other Tenants with equipment or operations that have the possibility of backflow. These must be certified and acceptable to the water district and checked yearly or as required by the local authority having jurisdiction.

KITCHEN EXHAUST REQUIREMENTS

- **LANDLORD REVIEW** is required to ensure the exhaust does not compromise the ventilation air of adjacent mall roof top units.
- **EXHAUST FAN** must be a SWSI centrifugal fan fitted with a minimum 10'-0" stainless steel upblast. Guy wires must be attached to the roof to secure the stack.
- **GREASE GUARD** containment system must be installed to protect the roof. Quarterly maintenance program is required for the grease containment system. Proof of maintenance contract must be presented to the Landlord prior to opening.
- **"SUPREME" HEAVY DUTY GBD BLOWERS** are required for all kitchen exhaust or grease laden air removal.

FUMES AND ODORS

The following constitutes the minimum requirements for special exhaust systems which Tenant must furnish and install in the Leased Premises for the elimination of fumes and odors due to Tenant operations:

- A total negative pressure of ten percent (10%) must be maintained during all hours that Tenant is operating its business in the Leased Premises.
- The HVAC system must be modified to provide additional make-up supply air to offset the quantity of air exhausted.
- The Tenant must have a certified air balancing contractor test the completed system and verify its operation according to these specifications. A copy of the air balancing report must be submitted to the Mall General Manager for review and approval prior to opening for business.
- The combined HVAC and exhaust system per the above-noted specifications must be in operation during all hours that Tenant is operating its business in the Leased Premises.
- The combined HVAC system must be connected to the Landlord EMS by the Landlord required contractor. See the Technical Criteria section for specifics.
- Indoor tenants which will be using any type of gas, liquid or solid fuel for heating, cooking or other use, must have an active carbon monoxide detector installed. The type should be and Hardwire Interconnectable 120- Volt Carbon Monoxide Alarm with Digital Display and Battery Backup.
- Carbon dioxide detection is required if tenant has a carbon dioxide systems with 100 lbs. or more of carbon dioxide used in their beverage dispensing applications.

RESTAURANT SPECIFIC REQUIREMENTS

PLANS MUST SHOW sizes and locations for all duct and piping through roof as well as all required fireproofing.

CONTAIN ALL GARBAGE AND REFUSE AREAS WASH DOWN "grey" water and properly drain off into city approved system (i.e. sewer or storm).

GAS UTILITY

Natural gas service is available for Tenants to obtain from the local gas company. Gas is permitted for cooking equipment only. Gas is not available for HVAC.

> CONTENTS

DESIGN

STOREFRONT / PREPARATION AS THEATER

CONTROL AREAS / SEATING

EXTERIOR

SIGNAGE

STOREFRONT / MENU BOARDS

TECHNICAL

SECTIONS OF INTEREST

INLINE CRITERIA

Includes standard design, technical, and sign requirements in addition to the contents in this section.

DESIGN INSPIRATION

Provides design inspirations for visual aesthetics.

BUILDING DETAILS

Includes Property reference photos and specific Storefront design details.

PROPERTY INFO

Includes information on the Property's building codes, area permitting, and required contractors.

SUBMITTALS

Outlines requirements on how and what to compile for submittals to the Landlord for design reviews.

The Restaurant Criteria provides key technical information and design requirements to ensure your interior or exterior facing restaurant food service enlivens the consumer experience and interfaces with the Center.

This criteria will often point to the [INLINE RETAIL CRITERIA](#) as several requirements and design concepts are shared. The content in this section highlights the unique concepts for food service design.

The tenant and the tenant's architect assume the following important obligations:

- Fulfill the intent of the Criteria both in concept and in detail.
- Determine and respond to the actual physical conditions of the Tenant's location.
- Maintain and enhance the high standards of quality established in the construction of the Center.
- Ensure the quality of execution of all design material, finish, and detail concepts in the construction of the Tenant's improvement.
- Provide the required detail at all transitions from Tenant Storefront to neighboring Storefronts, as well as to the base building.



> DESIGN > STOREFRONT / PREPARATION AS THEATER

Restaurant Food Tenants must adhere to the design requirements found in the [INLINE DESIGN CRITERIA](#).

In addition to the requirements detailed in the Design Criteria, Tenants serving food in their space must adhere to the following design requirements:

GENERAL STOREFRONT AND DESIGN

We encourage a cohesive presentation of the brand within the context of the whole Mall design, while the individual brand is important and the two must harmonize. Design should be tailored to its location both within the community and the whole Center's aesthetics.

Restaurants may face both the interior and the exterior, and are often located adjacent to a Mall entry. The exterior and the interior are subject to different Criteria standards, both for presentation and signage.

Interior restaurants oftentimes have a waiting area within the common space.

- If needed these must be shown in the submissions and be approved by Landlord. They must be coordinated with common area needs and code requirements.

PREPARATION AS THEATER

Tenant's offering a peek into the making of food, by nature, include the customer and make for an authentic experience. This inclusion of the customer will increase engagement and is highly encouraged.



> DESIGN > CONTROL AREAS / SEATING

CONTROL AREAS

The DCA is the area at the front of the Tenant space that extends from the lease line to all points 6'-0" into the space. It should convey excitement and give the consumer a reason to engage.

Exposed patios are encouraged however, they should not extend beyond the lease line. In special cases there may be opportunity to extend the patio but it must be in compliance with all common Mall code and circulation requirements.

Projection or canopies may increase the visibility of the Storefront over seating areas. They also help with lighting the Storefront.

In addition to the general DCA Criteria for inline stores the following requirements must be met:

- All patio rails, reception podiums, waiting areas, menu presentations, lighting, heating, visible banquet detailing, and material palettes must be presented for review and approval.
- Common Mall flooring must be maintained. Coordinate with Landlord design if railings or other elements will have an effect on the flooring.

SEATING

Where interior seating is needed or desired, it is suggested that the enclosure line be moved into the lease space by approximately twelve (12') feet.

Seating design requirements include:

- Patio seating must be separated from the common area circulation in the Mall. A layout will be required for review.
- All visible furniture must be reviewed by the Landlord for suitability both aesthetically, as well as for performance specifications.
- Tenant is responsible to confirm additional requirements with the local authorities for any railing or barrier for the Tenant's proposed area.



> DESIGN > EXTERIOR

Restaurants with exterior storefronts will be subject to the general inline design criteria in this manual, for aesthetics.

Exterior design should be tailored to its location both within the community as well as the whole Center and its aesthetics.

SITE PLANS

- A Site Plan must be submitted that includes all required calculations for GLA, GBA, and parking requirements.
- Site Circulation must be included showing the adjacent intersections, driveways, drive directions, and dimensions of all access points.
- Photos of adjacent and onsite conditions may be required by ownership for the review process.

AMENITIES

- Planters, heat lamps, tables, chairs etc., must be submitted for approval. All amenities must be commercial grade and suitable for outdoor use.
- Pendant or sconce lighting must be submitted for approval by Landlord.
 - Lighting plans of canopies and trellis are available in Landlord supplied base drawings.
- Umbrellas are only allowed in the designated areas and cannot overhang into the public right-of-way.
 - Umbrellas should be small in scale (maximum 6'-0" in diameter) and no more than 9'-0" high at the peak.
 - Wood or metal are the only acceptable materials for the umbrella structure. No insignia, graphics or text are permitted on the umbrella fabric.
 - The umbrella fabric must be flame retardant material in a color approved by Landlord's Tenant Coordinator.

EXTERIOR PATIOS

- Any changes to an existing patio must be approved by Landlord. Tenant is responsible to confirm the requirements with the local municipality for proposed use.
- Temporary elements such as greeting stands, waiting areas must be submitted for review.
- Confirm code height and density of railings for of any necessary barriers.
- Patio layouts with adjacent circulation dimensioned must be included in the first submittal of documents for design review.
- Railing design details should be submitted with the concept and construction packages for approval by the Landlord design team.

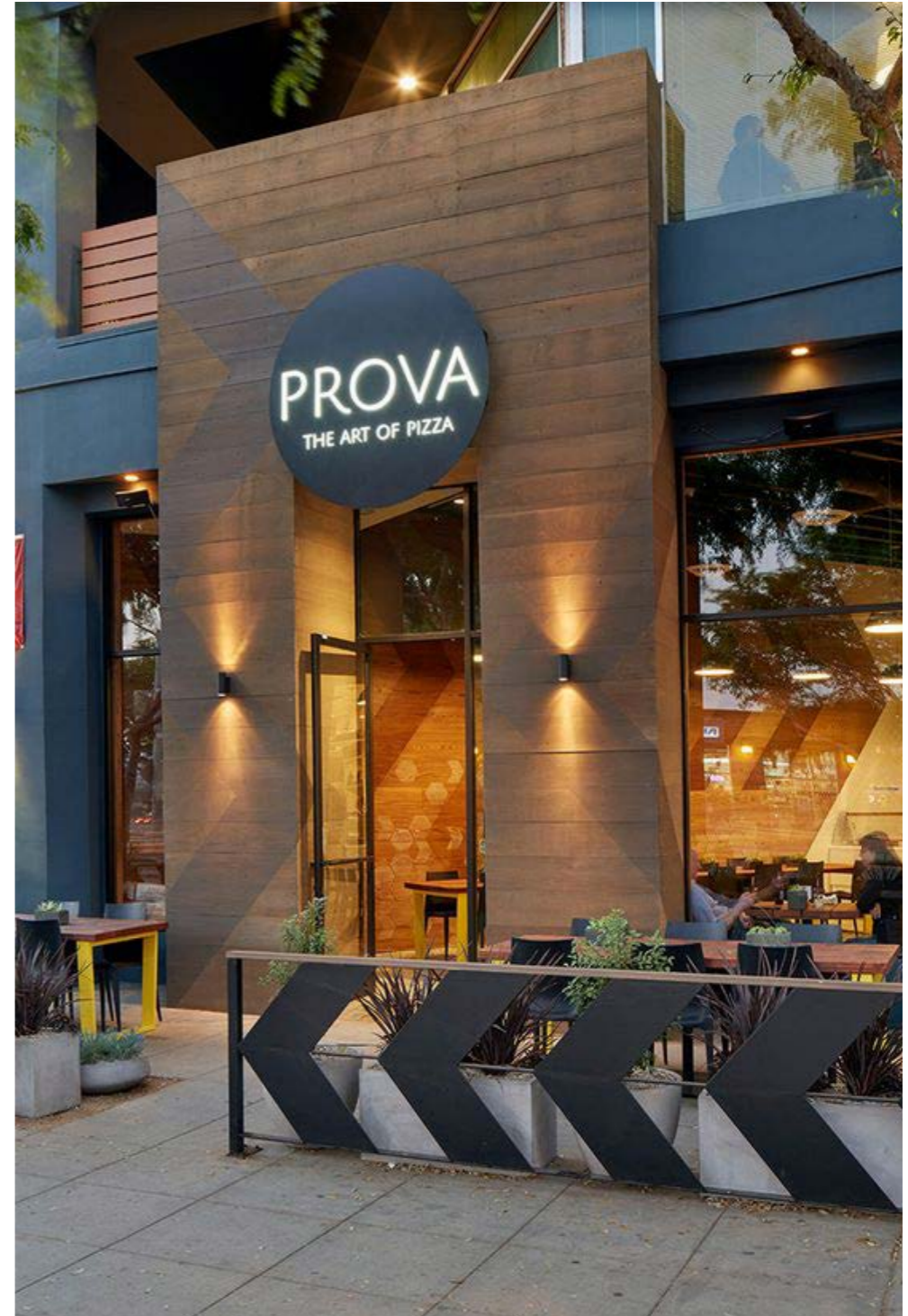

> SIGNAGE > PRIMARY / MENU BOARDS

PRIMARY STOREFRONT SIGN

Inline and Restaurant Food Tenants must adhere to the Signage requirements found in the [INLINE SIGN CRITERIA](#).

Exterior signage must adhere to the requirements established by the local municipality.

MENU BOARDS

Inline and Restaurant Food Tenants must adhere to the menu board requirements found in the [FOOD COURT SIGN CRITERIA](#).



> TECHNICAL

Inline and Restaurant Food Tenants must adhere to the technical requirements found in the [INLINE TECHNICAL CRITERIA](#).

In addition to the requirements detailed in the Technical Criteria, Tenants cooking food in their space must adhere to the same requirements found in the [INLINE FOOD TECHNICAL CRITERIA](#).

CONTENT OVERVIEW

3.1

DESIGN INSPIRATION

PROVIDES DESIGN INSPIRATIONS AS TO WHAT KIND OF KIOSK DESIGNS CAN BE PRODUCED.

3.2

DESIGN ELEMENTS & REQUIREMENTS

DETAILS DESIGN CONCEPTS AND REQUIREMENTS TO INCORPORATE INTO THE OVERALL KIOSK DESIGN.

3.3

FOOD DESIGN ELEMENTS & REQUIREMENTS

DETAILS SPECIFIC DESIGN ELEMENTS AND REQUIREMENTS FOR KIOSKS SELLING AND COOKING FOOD.

3.4

TECHNICAL

DETAILS THE TECHNICAL DESIGN REQUIREMENTS TO INSURE THE KIOSK INSTALLATION INTERFACES WITH THE UTILITIES AT THE CENTER.

3.5

PROCESS

PROVIDES AN OVERVIEW OF THE DESIGN, CONSTRUCTION, AND INSTALLATION OF KIOSKS.

3.6

DESIGN DETAILS

SPECIFIC DESIGN DETAILS REQUIRED TO BE ADOPTED AND SHOWN IN THE KIOSK DESIGN SUBMITTAL DRAWINGS.

SECTIONS OF INTEREST

DESIGN INSPIRATION

Provides visual inspirations for design aesthetics.

PROPERTY INFO

Includes information on the Property's building codes, area permitting, and required contractors.

SUBMITTALS

Outlines the requirements on how and what to compile for submittals to the Landlord for design reviews.

Macerich strives to differentiate its shopping environment through fresh, innovative design and unique retail offerings. We transform everyday shopping into a truly unexpected and exhilarating experience.

Innovative design has proven to stimulate customer interest which in turn drives sales. For Macerich and kiosk Tenants to achieve this goal, we ask our tenants to fabricate a high quality, experiential retail design that is cohesive and complimentary to the overall shopping center environment.



> CONTENTS

- URBAN
- ARTISAN
- WHIMSICAL
- INVITING
- ARTSY
- THEATRICAL

SECTIONS OF INTEREST

The following sections provide additional details and requirements related to this Criteria:

- DESIGN INSPIRATION*
Provides additional visual inspirations for design aesthetics.

GET INSPIRED!

The following inspirations are intended to help you visualize what kind of kiosk design can be produced. These aesthetic examples encourage bold design to draw customers and enliven the common area visuals of the Center. By the nature of their prominent locations, kiosks require great design and an attention to detail to ensure high quality retail experiences.

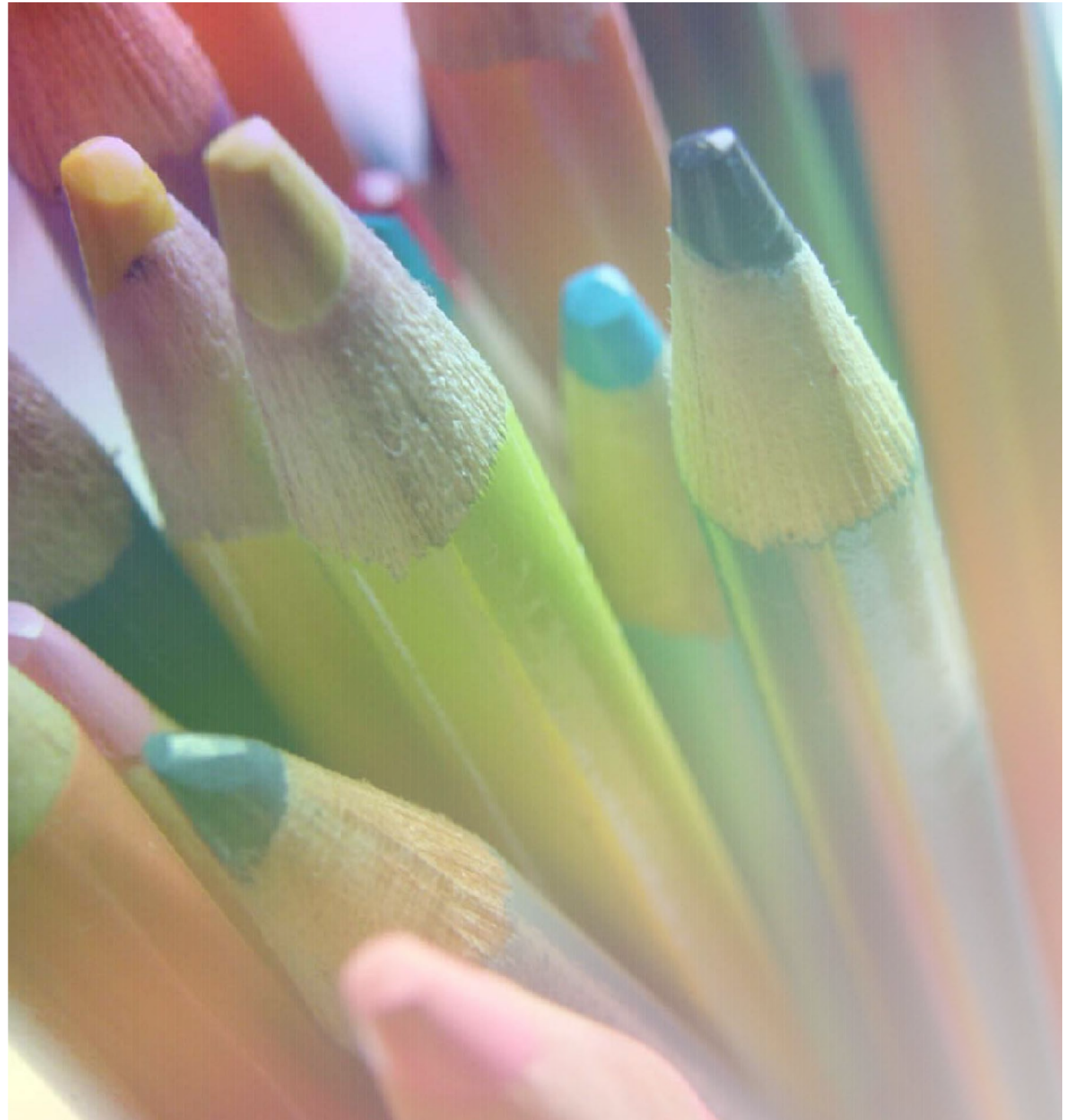

> URBAN

URBAN

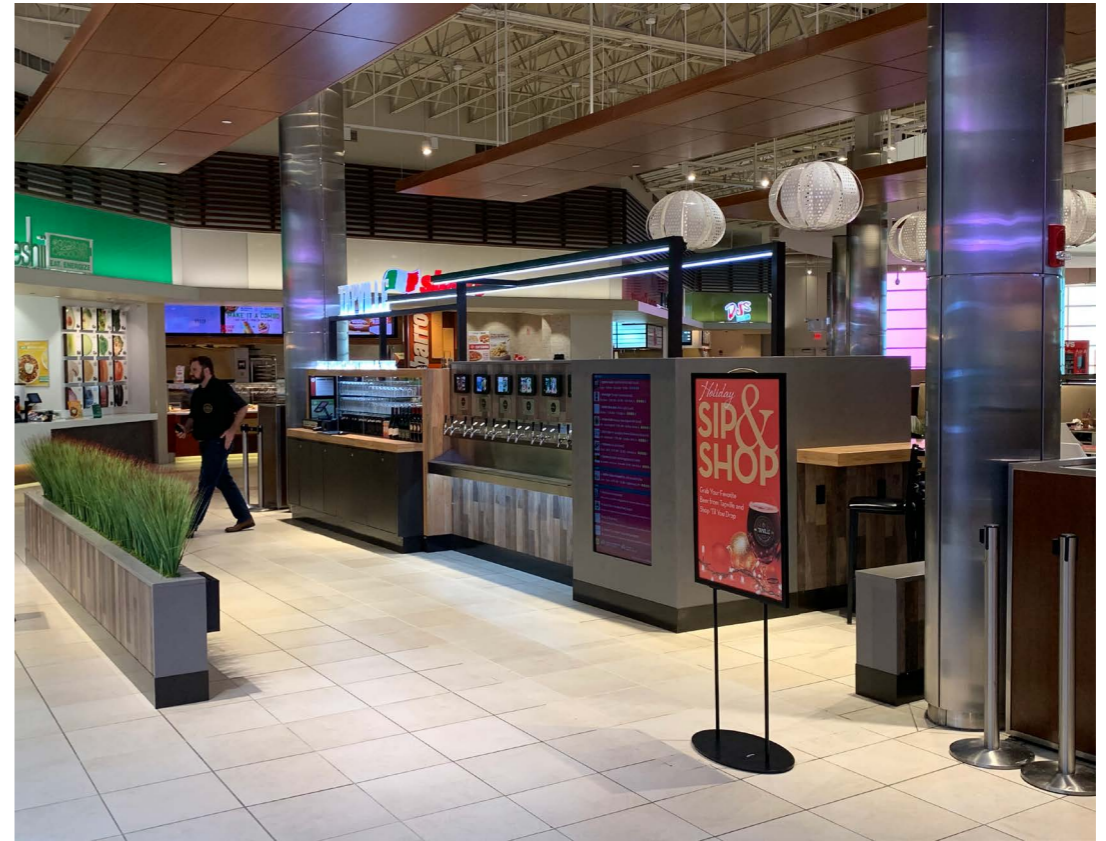

EDGY, FUNKY, STREET SAVVY STYLE, INDUSTRIAL

> ARTISAN

ARTISAN



NATURAL, SOPHISTICATED, UNIQUE

> WHIMSICAL

WHIMSICAL



UNEXPECTED, PLAYFUL, COLORFUL

> INVITING

INVITING

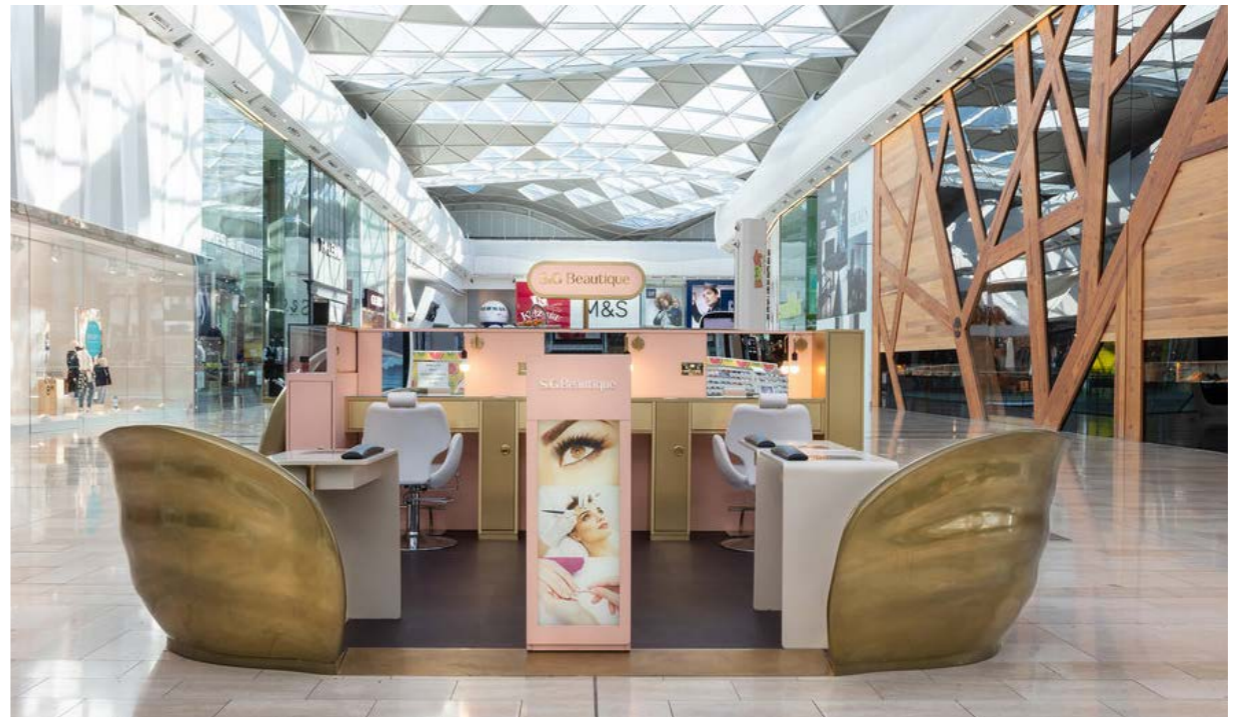

WARM, CALM, OPEN, SOFT

> ARTSY

ARTSY



QUIRKY, AVANT GARDE, SURPRISING

> THEATRICAL

T H E A T R I C A L



DRAMATIC, HIGH CONTRAST, MOVEMENT

> CONTENTS

WELCOME!

This section provides an overview of the numerous design elements and requirements to consider and follow when designing your kiosk. The elements detailed in this section apply to both dry retail kiosks and “wet” food kiosks that prepare food within the kiosk. The next section will detail specific additional elements for food kiosks.

- TRAFFIC FLOW
- QUEUING
- SEATING
- LAYERING ELEVATIONS
- VISUAL MERCHANDISING
- BRANDING
- TECHNOLOGY AND MEDIA
- MATERIALS AND FINISHES
- LIGHTING & ILLUMINATION
- ACCESS GATE
- FLOORING
- STORAGE
- TOE KICK
- PYLONS
- DIMENSIONS

SECTIONS OF INTEREST

The following sections provide additional details and requirements related to this Criteria:

- DESIGN INSPIRATION*
Provides visual inspirations for design aesthetics.
- PROPERTY INFO*
Includes information on the Property’s building codes, area permitting, and required contractors.
- SUBMITTALS*
Outlines the requirements on how and what to compile for submittals to the Landlord for design reviews.



> TRAFFIC FLOW

TRAFFIC FLOW

Taking into account the flow of mall traffic, an open layout can:

- Increase SKUs. The unit can be shopped from the inside and outside.
- Encourages interactive shopping.
- Let's the customer assess your product before they engage, decreasing your sales transition time.
- Creates a more sculptural design, drawing more attention to your product.

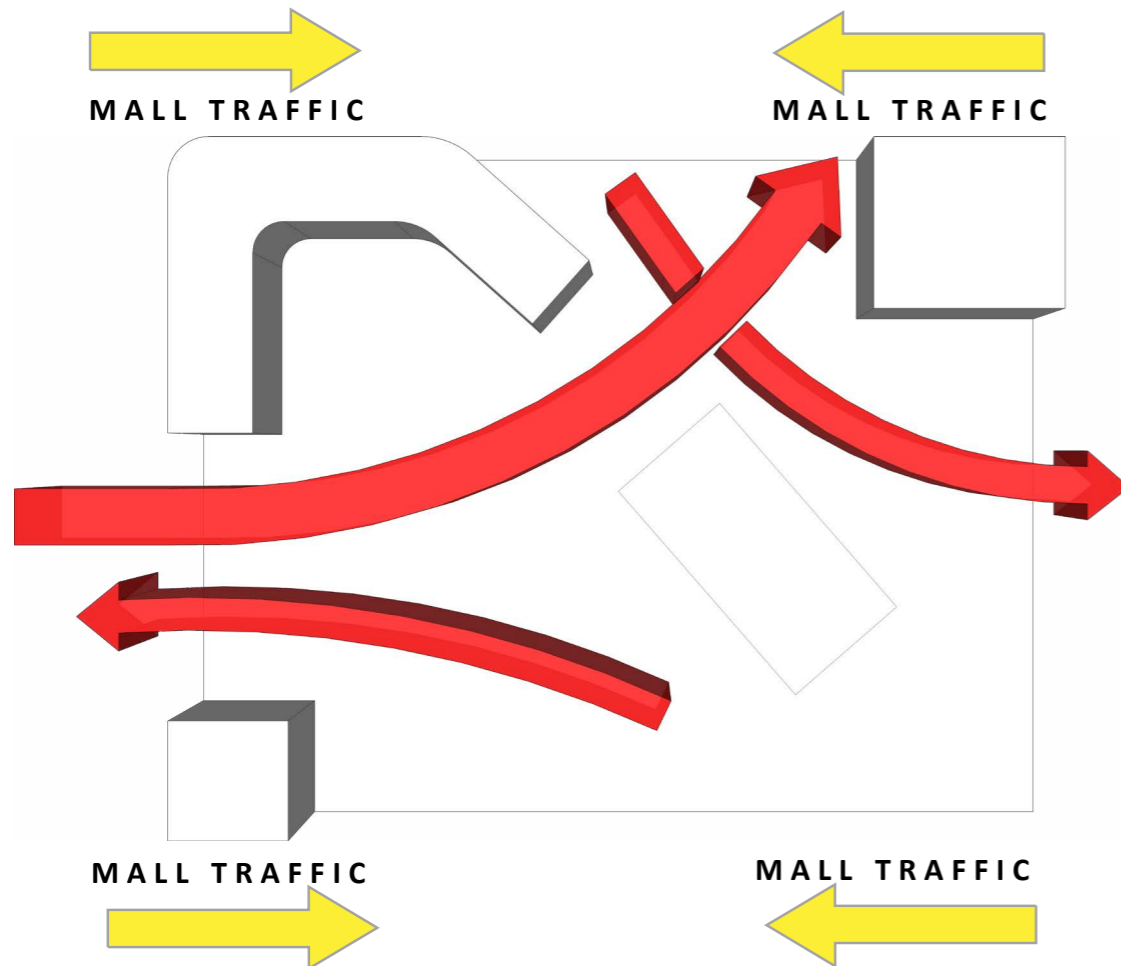

> QUEUING

QUEUING

It is important to consider the flow of customer traffic as they queue to place an order. Be certain to make accommodations for lines of customers navigating the space around your kiosk.

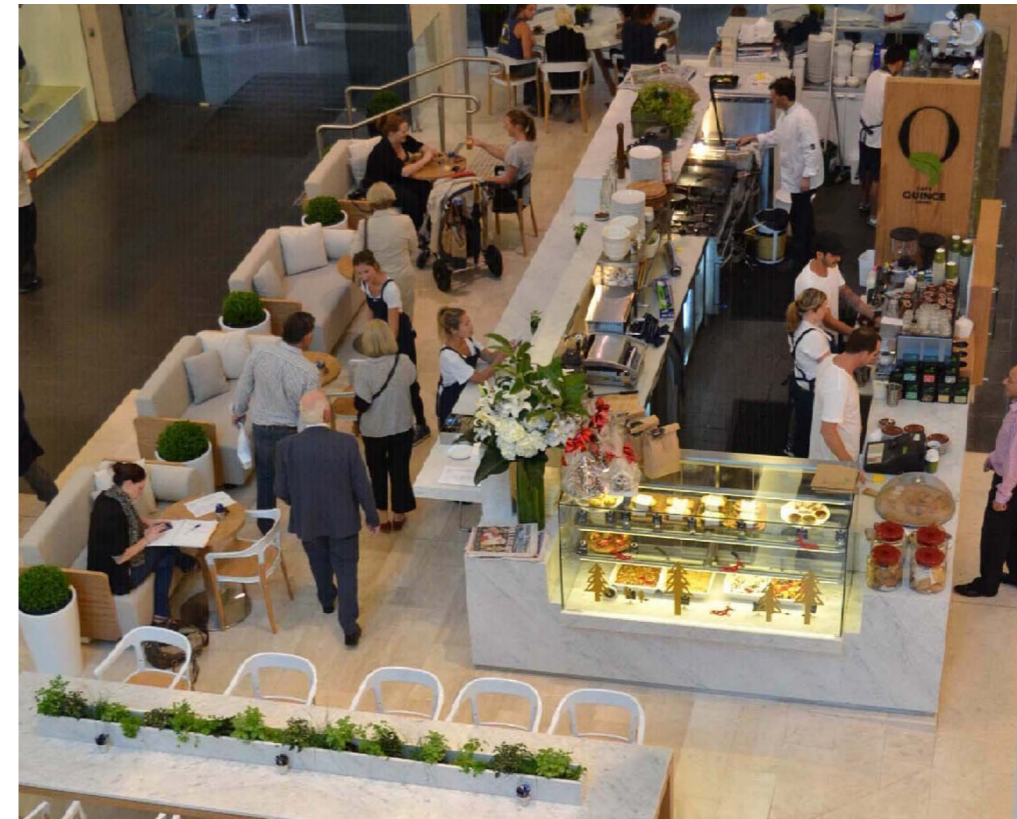

> SEATING

SEATING

Macerich's vision is to create food uses as "dwell" areas or destinations for the core malls.

We encourage curves and angles to differentiate public spaces versus back of house areas for the following reasons:

- Encourages areas for seating and dwelling.
- Creates transitional areas for shopping versus resting.
- Makes for a sculptural design, which in turn draws attention to your business.
- Curves, plants, soft lines create an inviting and relaxing atmosphere to encourage dwell time.

Dedicated kiosk sitting is also encouraged.

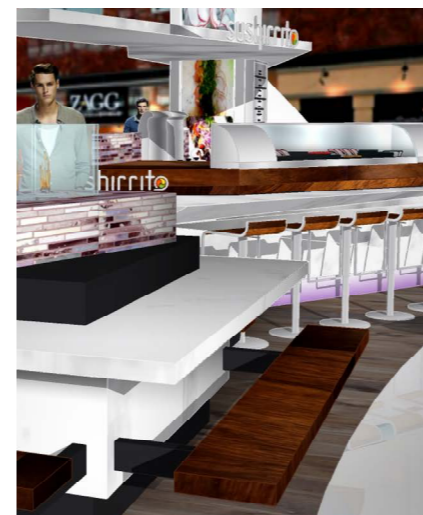
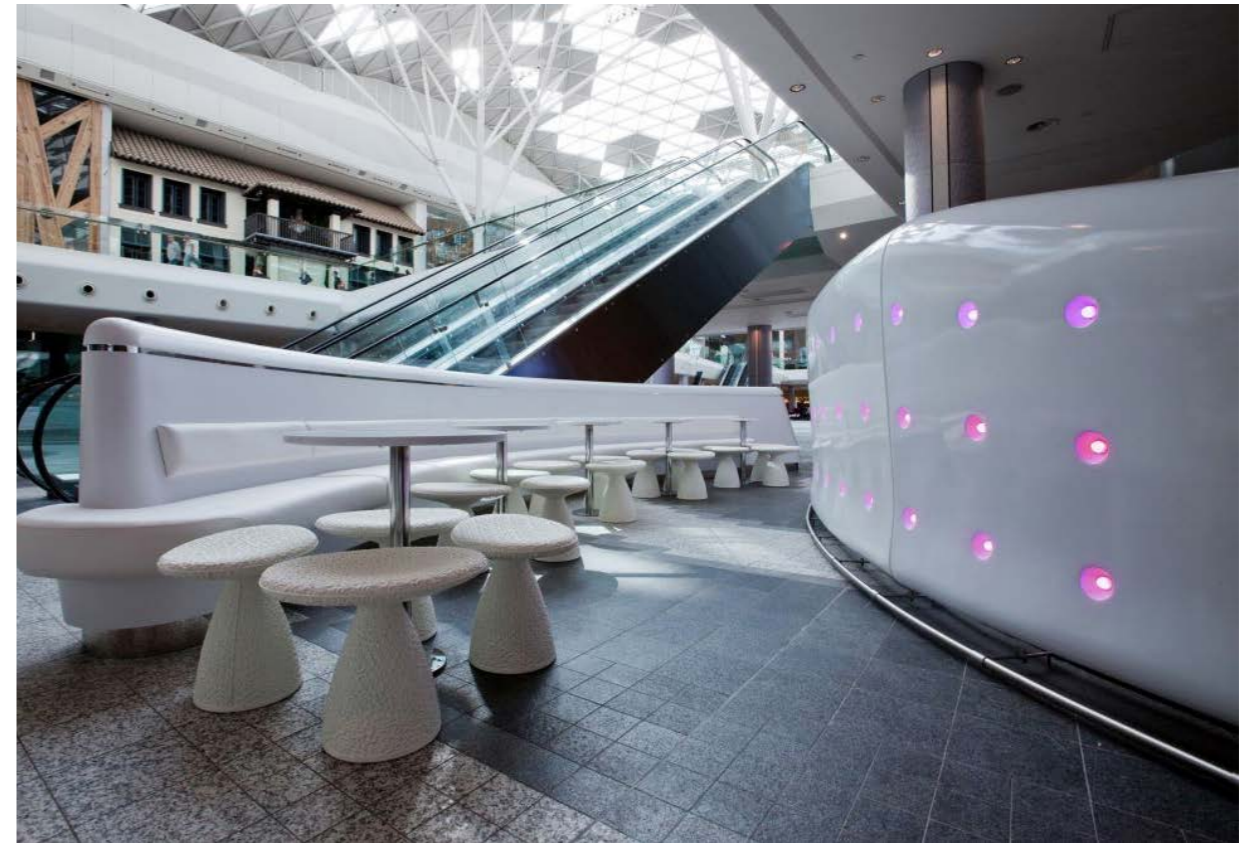

> LAYERING ELEVATIONS

LAYERING ELEVATIONS

Walls and elevations can be used to make a canvas that communicates to your customer. An eye catching layered elevation may include:

- Walls with patterns and textures
- Overlays of materials
- Dimensionality
- Molded shapes
- Overlaps to create shadows and depth
- Cove lighting for extra dimensions



> VISUAL MERCHANDISING

VISUAL MERCHANDISING

Strong visual presentation and merchandising are essential and integral components of retail design.

- Always try to create a triangular composition within style groups or color groups. (display in groups of three or five).
- Start with a center feature, (best sellers / hot items), and merchandise out symmetrically.
- Balance merchandise.
- Color block merchandise to create organized zones.



S E T Y O U R S T A G E ,

S E L L A S T O R Y

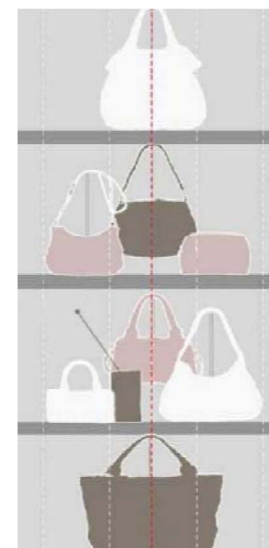

> BRANDING

BRANDING

A brand is a name, term, design, symbol, color or some other feature that identifies a seller's product or services as distinct from those of other seller's.

Whether you have an established brand or are starting your first business, the kiosk team will work closely with you to enhance your brand look, so you stand out to potential customers and fit with the Macerich experience. This will help you towards the success of your business.

Your branding can be communicated with signage, graphics, materials, shapes, colors, textures, patterns and the overall look and feel of your kiosk, to tell a story and create a lasting experience.

- Taglines are not permitted.
- Graphics must be mounted behind glass or acrylic and secured with stand offs.
- Handwritten signs are not permitted.
- All signage must be Approved by the Landlord.



	£3.95	£3.90	£4.50	£2.45
1 serving	£3.70	£4.25	£5.25	
2 servings	£4.45	£5.00	£5.00	
3 servings	£5.40	£5.65	£5.65	

Shake up your Snog
Over 100 toppings to mix with yogurt in a variety of ways

£3.95				



> TECHNOLOGY & MEDIA

TECHNOLOGY AND MEDIA

Technology can enhance your on line operation by transforming your kiosk space into a multifunctional one, that lends itself to being an in store pick up location, payment booth or advertising billboard.

Integrating technology into your kiosk can:

- Become an extension of you.
- Supplement your salesforce with interactive screens for ordering, design yourself functions and more.
- Keep your business connected with your customer.
- Help you tell a story.
- Help make menu boards easier to update and better communicate your offerings to your customer via LCD screen loops.

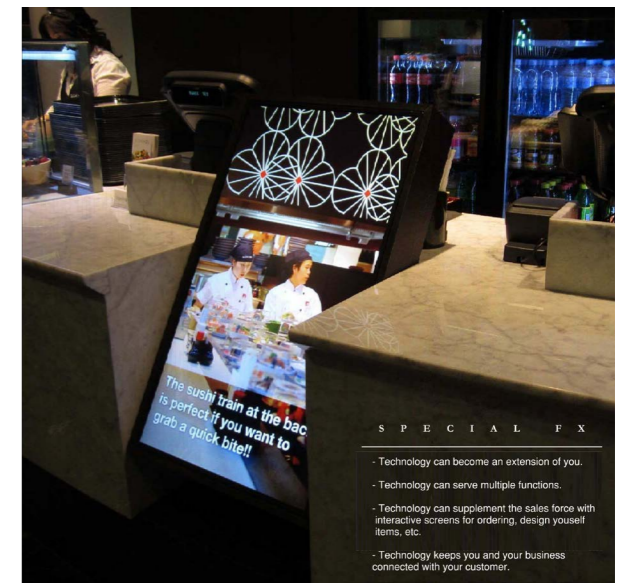

> MATERIALS & FINISHES

MATERIALS AND FINISHES

Kiosks experience heavy foot traffic and engagement. As such, kiosk materials and finishes must be durable and designed to withstand heavy wear and cleaning machinery.

- A material sample board must be submitted for Landlord approval before fabrication can begin.
- Building materials must be fire retardant, fire treated or non-flammable. Class A materials per building codes must be used.
- Selected materials must be authentic and natural such as woods, stones, reclaimed woods, mosaic tiles, etc.
- Plastic laminates are not permitted with the exception of color core or wood pattern high performance plastic laminates.

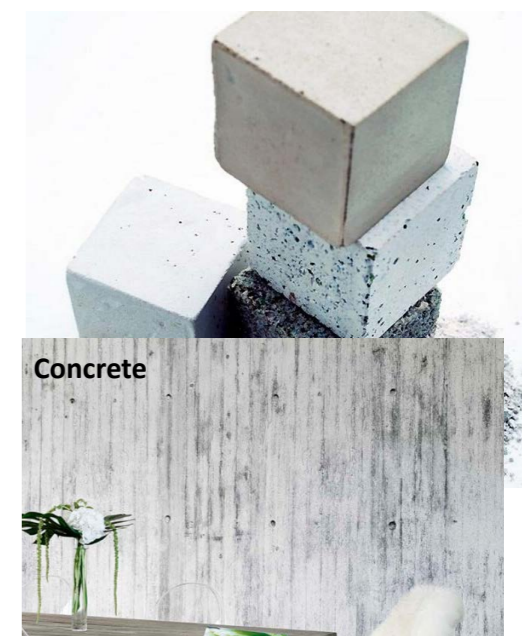
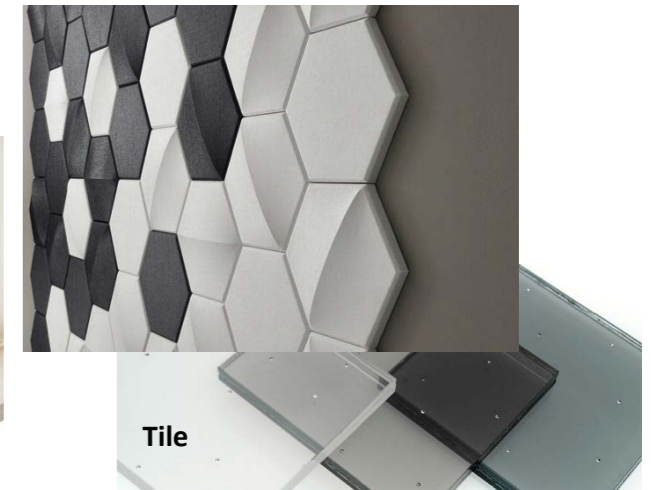

> LIGHTING & ILLUMINATION

LIGHTING AND ILLUMINATIONS

Lighting can be used to draw attention, create depth, and enhance the overall design of your kiosk.

- Light fixtures must be low profile and approved by the Landlord.
- Case lighting must be seamlessly integrated into the design.
- Ensure that the light source is concealed.
- If your kiosk is located under the ceiling, additional lighting elements may be considered but it must be connected to the Tenant's circuit.
- No track lighting or cable hung fixtures are allowed.
- No overhead canopies are allowed.
- All lighting must meet applicable building codes and safety requirements and will require Landlord approval prior to installation.



> FLOORING

FLOORING

Flooring is an important design element in an open kiosk layout for the following reasons:

- It is inviting and welcoming.
- It defines your footprint.
- Conduits can be run between cabinetry beneath the floor.

We encourage a wood flooring material like plank, for a warm look and feel.

Flooring requirements include:

- All flooring must be approved by Landlord prior to installation.
- It is a code requirement to comply with the ADA. (1" = 12" - transitional slope).
- Flooring must be laid over existing mall flooring. Mall flooring is not permitted to be removed.

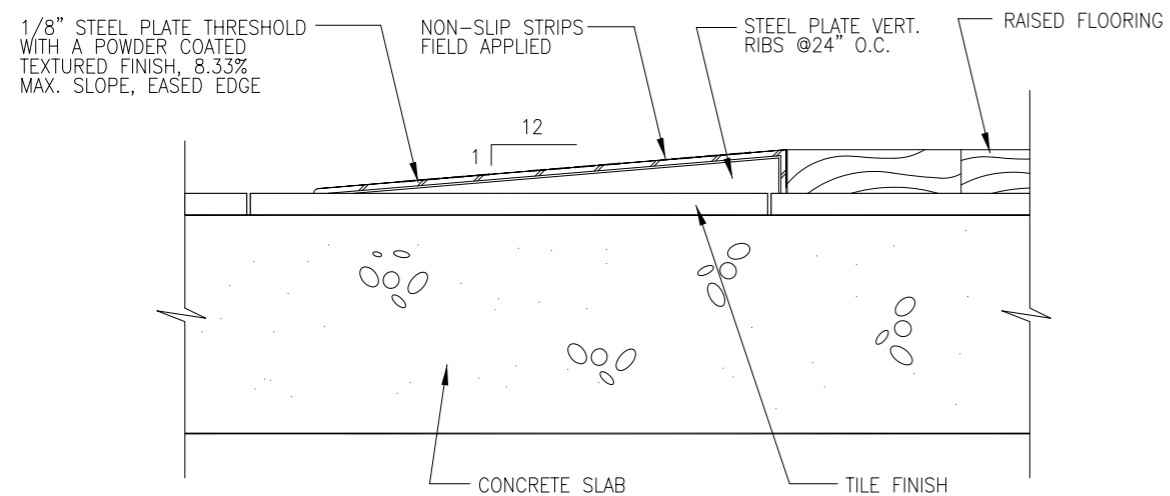

RAISED FLOOR THRESHOLD

SCALE
6" = 1'-0"

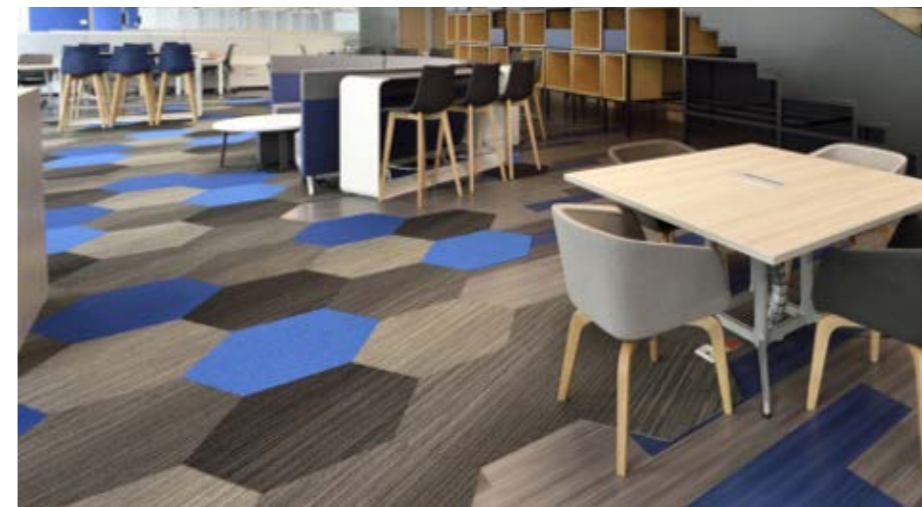

> ACCESS GATE

ACCESS GATE

A gate to enter a kiosk is a necessity. However it is not necessary for the customer to know where the gate is located.

- The gate must be seamlessly integrated into the overall design, to avoid being an eyesore.
- The gate shall be installed no more than 1" maximum above the finished floor.



> STORAGE

STORAGE

Maximizing sales volume naturally requires product storage within your kiosk. Storage should be integrated into your design to make it invisible to the customer.

- All interior storage must have doors or fixed fronts within the retail space.
- All cabinet hardware must be low profile, commercial grade stainless steel.
- Integrate all counter top displays into the design. No freestanding loose spinners or displays are permitted.
- All front counter service equipment must be shrouded to conceal cables or loose items from public view.
- Bins and brochure holders must be integrated into the overall design.
- Low profile hardware for cabinets and drawers are required.
- Merchandise must be placed in shelving that designed in line with the kiosk's overall look and feel.
- Equipment, cords, cables, and loose items are required to be hidden from the public view. Your kiosk design should include shrouding.

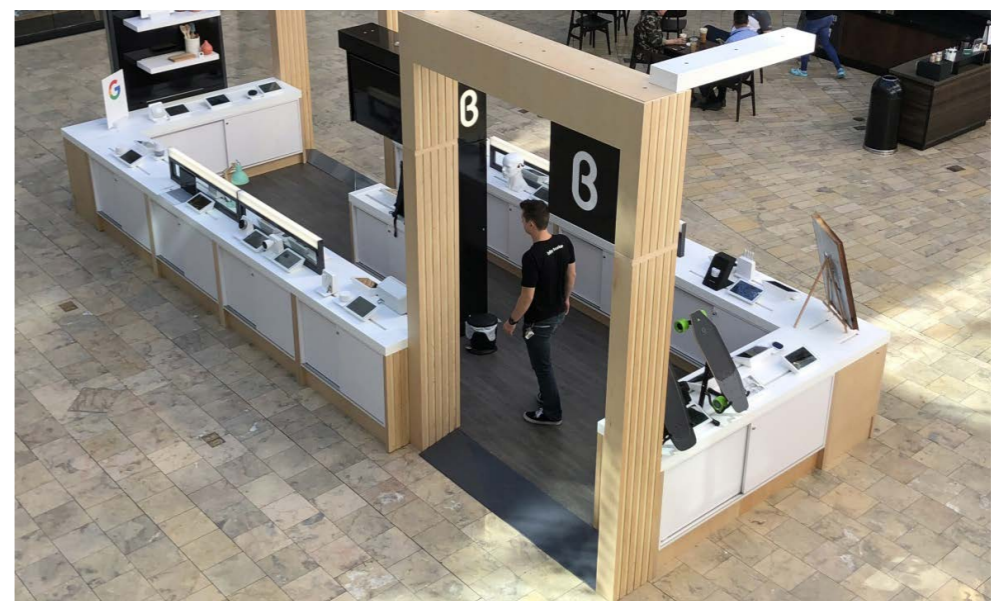

> TOE KICK

TOE KICK

Toe kicks are important as they minimize damage to your kiosk from foot traffic and cleaning machinery.

- Kick material must be durable.
- Kick should be 6" high and 3" inset.
- An 1/8" metal extrusion at the toe kick is required to protect kiosk finishes from foot traffic and cleaning machines.



> PYLONS

PYLONS

We encourage your design incorporate a pylon shape that enhances your brand experience and communicates what you are offering.

If your lease line includes a column, you have a unique opportunity to brand it with additional signage and accent lighting.

- Design must be integrated and coherent with the retail design.
- Max allowable size is 7' tall by 3' wide.
- Secondary pylons are encouraged at a maximum size of 4' tall by 3' wide.
- Freestanding neon or neon lit signs are not permitted.
- All signage must be Approved by the Landlord prior to installation.

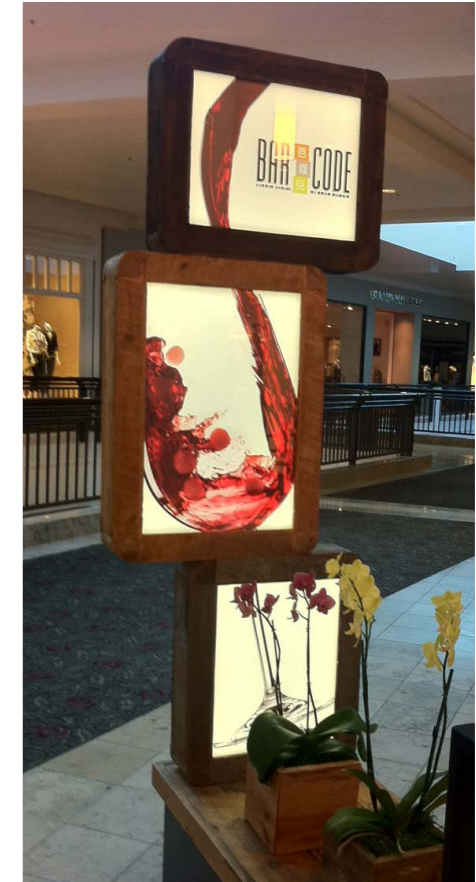

> DIMENSIONS

DIMENSIONS

We want your kiosk to stand out and attract customers through excellent design. With that in mind, it is also important to keep common area sight lines open. To achieve this, we have a few dimensional requirements to follow:

- A maximum height for opaque walls is 4'-0", with a 1'-0" translucent glass shroud up to a 5'-0" total height, where required by the Health Department.
- Max allowable pylon size is 7' tall by 3' wide.
- Secondary pylons are encouraged at a maximum size of 4' tall by 3' wide.

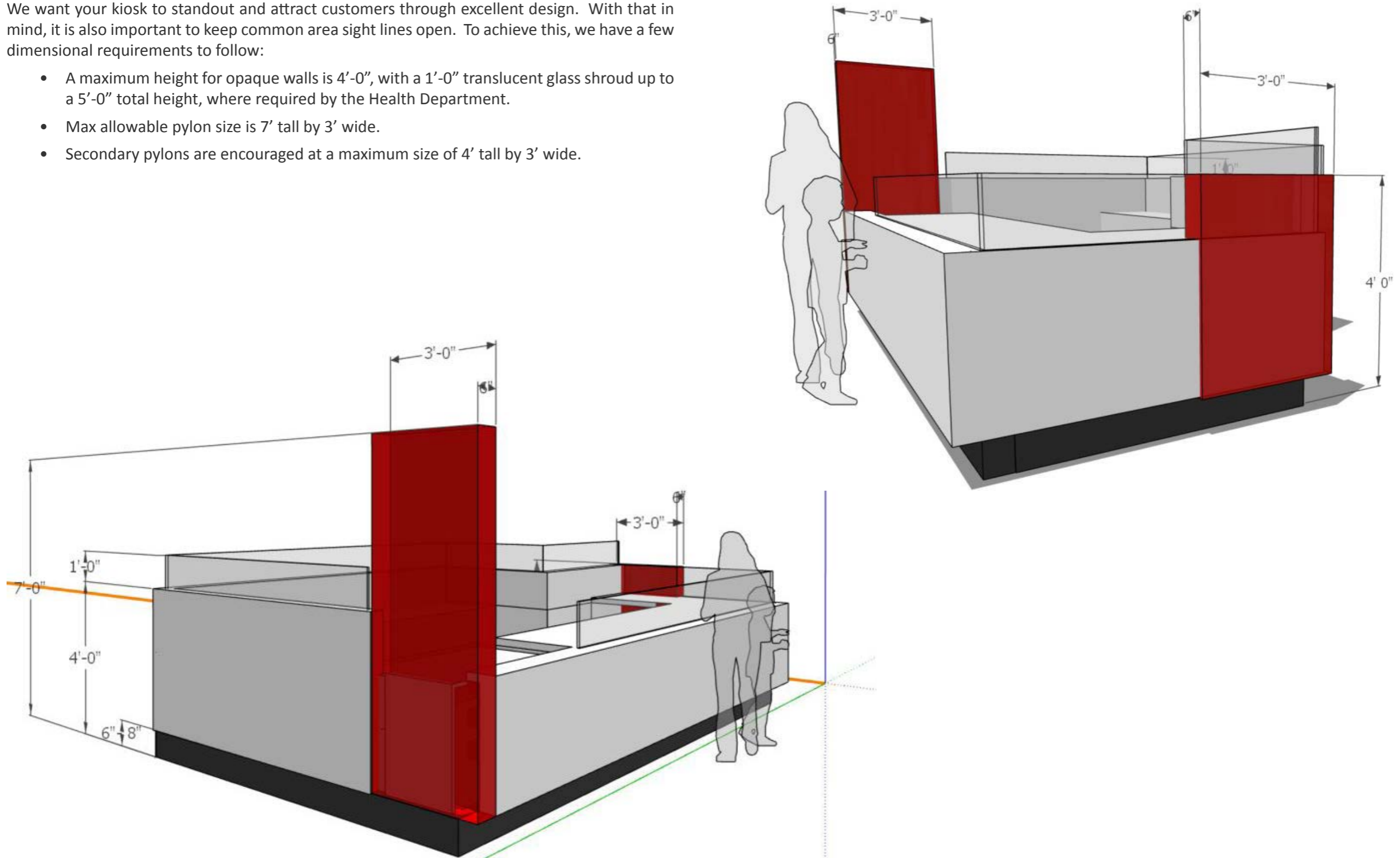

> CONTENTS

- FOOD DISPLAY**
- FOOD PREPARATION AREA**
- MENU BOARDS**
- CONDIMENTS AND UTENSILS**

SECTIONS OF INTEREST

The following sections provide additional details and requirements related to this Criteria:

- DESIGN INSPIRATION**
Provides visual inspirations for design aesthetics.
- PROPERTY INFO**
Includes information on the Property's building codes, area permitting, and required contractors.
- SUBMITTALS**
Outlines the requirements on how and what to compile for submittals to the Landlord for design reviews.

A FEAST FOR YOUR EYES!

This section provides an overview of the specific design elements and requirements to consider for a “wet” food producing kiosk. It is important to embrace the cooking and display of food as an integral design element to your kiosk. Food is a great tool to entice the consumer.



Visible food preparation is an added value, resulting in excitement and interaction for the customer.

> FOOD DISPLAY

FOOD DISPLAY PRESENTATION

We encourage you to incorporate food display of your goods to showcase your brand to customers. Presenting freshly made options from the menu will entice the eyes of your customer and provide an instant way to purchase an item. Labeling your items helps identify your offerings.

- Food displays must be appetizing and behind clean and clear glass.
- Labels should accent the design of your kiosk.
- Signage should be professionally printed on card stock and utilize proper display methods.



DISPLAY THE GOODS IN AN APPETIZING MANNER.



> FOOD PREPARATION AREA

FOOD PREPARATION AREA

Visual food preparation is an added value to your brand experience, resulting in excitement and interaction for the customer.

- Obstructive overhead canopies are not permitted. An alternative solution to an overhead canopy should be used if one is required by the Health Department.
- Check local building codes for requirements on plumbing venting inside a wall or if it occurs on the exterior wall.
- Odor producing equipment is not permitted. Tenants must enclose all odor within their premise.

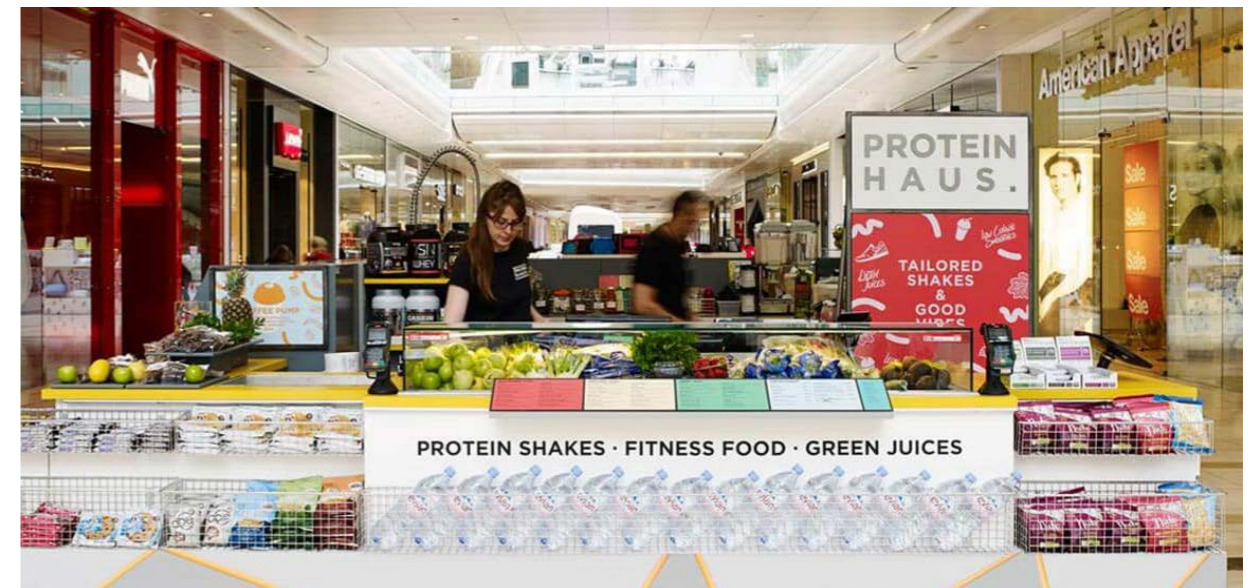

> MENU BOARD

MENU BOARD

Your menu board is a vital brand element to communicate your product to the customer.

- Design must be integrated and coherent with the retail design.
- Loose menu boards are not permitted.
- The top of the menu board may not exceed a height of 5'. The only exception is when the menu board is located on a pylon.



> CONDIMENTS & UTENSILS

CONDIMENTS AND UTENSILS

Condiments, utensils, napkin holders, etc., can be an eyesore if not properly accounted for in the kiosk design.

- Items must be integrated seamlessly into the overall kiosk design.
- Loose items on the countertops are not permitted.



> ELECTRIC / DATA / PLUMBING / STORAGE

OVERVIEW

The Technical Criteria is designed to provide building details and design requirements for the Property's technical systems.

It is the Tenant's responsibility to verify existing conditions and comply with all applicable codes and standards for all technical systems.

Tenants are required to adhere to the full criteria during their design and construction.

ELECTRIC

Most retail kiosk spaces are typically provided 20 amps of low voltage power stubbed into a J-Box under the floor. In certain kiosk locations, more power exists. It is the responsibility of the Tenant to field verify the amount of existing power in their Premises, to ensure it suits the Tenant's needs, prior to signing the Lease.

Tenant kiosk installations are typically required to tap into the provided power, and distribute inside their kiosk. The following requirements must be met:

- **IDENTIFY** all Tenant equipment in the Mall electric room with clear labels that include the Tenant name and space number.
- **CUTTING AND PATCHING** must be provided by Tenant.
- **UL LABELS** on all material and equipment must be new and of a commercial grade and where such labeling applies, with panel ID and circuit number.
- **WATERTIGHT FLOOR BOXES** are required.
- **EXPOSED WIRING** is not permitted. All wiring of any type must be installed in conduit or must be metal clad cable (MC). Metal clad cable will only be allowed for concealed branch circuit wiring within the demised premises. Flexible conduits must be used for connections to vibrating equipment.
- **EXPOSED LOW VOLTAGE** wiring must be plenum graded.

DATA AND COMMUNICATIONS

Kiosk spaces are typically provided a conduit stubbed into a J-Box under the floor.

- **DATA SETUP AND SERVICE INSTALLATION** is the Tenant's responsibility to coordinate direct through Granite Grid. Other data providers are not permitted at this property as they do not have an access agreement in place.
- **TELEPHONE DEMARC WORK** must be performed by Landlord's approved telephone subcontractor, Granite Grid.
- **TELEPHONE SERVICE** is the Tenant responsibility to coordinate directly through Granite Grid and install within their premises.

PLUMBING

Kiosk spaces may or may not have existing wet utilities. It is the responsibility of the Tenant to field verify the wet utilities in their Premises, to ensure it suits the Tenant's needs, prior to signing the Lease.

Tenant kiosk installations are typically required to core into the floor, tap into the provided plumbing, and distribute inside their kiosk. The following requirements must be met:

- **GARBAGE DISPOSALS** are not allowed.
- **HAIR RECEPTORS** must be installed on all sinks, basins, and special sanitary units which may in any way receive human or animal hair.
- **GREASE INTERCEPTORS** must be installed within the kiosk footprint.
- **KITCHEN SINKS** including pot sinks, scullery sinks, pre-wash sinks and other kitchen units must be connected to a grease trap as per code.
- **DISHWASHERS** may not be connected to grease trap.
- **OIL COLLECTION AND HAULING SYSTEM** is required for Tenants with fryers or other grease/oil generating equipment that does not run through an interceptor. Landlord does not provide a centralized collection point.
- **FLOOR PENETRATIONS AND PLUMBING** by Tenants must be coordinated with the Landlord.

> DESIGN KICKOFF / DESIGN SUBMISSION / PERMITTING & CONSTRUCTION

This section provides a brief overview of the design, permit, and installation process steps to get your kiosk open.

DESIGN KICKOFF

We want to help you create an incredible kiosk to maximize your brand’s potential. Your Tenant Coordinator will contact your team to schedule a design kickoff call. The purpose of this call is to collaborate on your design intent and help you understand the requirements in this Criteria.

DESIGN SUBMISSION AND REVIEW

Requirements on how and what to submit for the Landlord drawing review of your kiosk can be found in the [SUBMITTALS CRITERIA](#).

PERMITTING AND CONSTRUCTION

An overview of both the City/Municipalities permit process and the Landlord’s construction requirements can be found in [PROPERTY INFO](#).

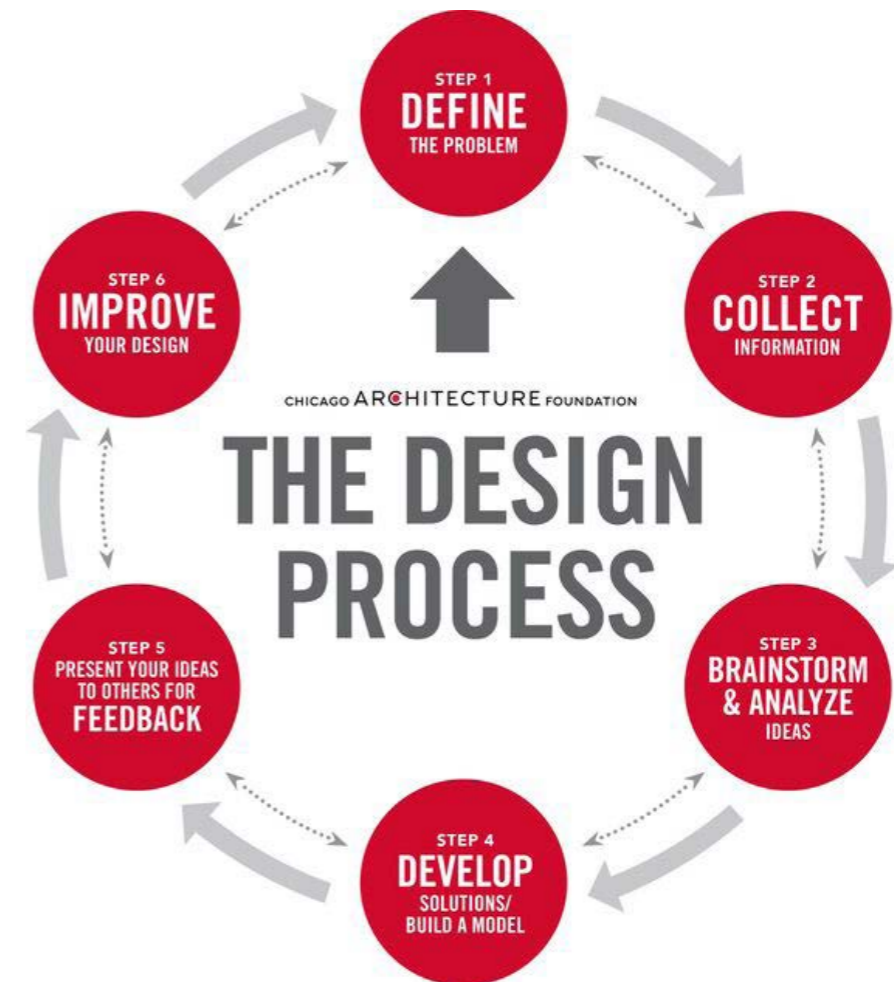

> GLASS SHROUD / GATE

The following design details are required to be shown in your final design drawings. These details will help to ensure your kiosk is sturdy and built to last.

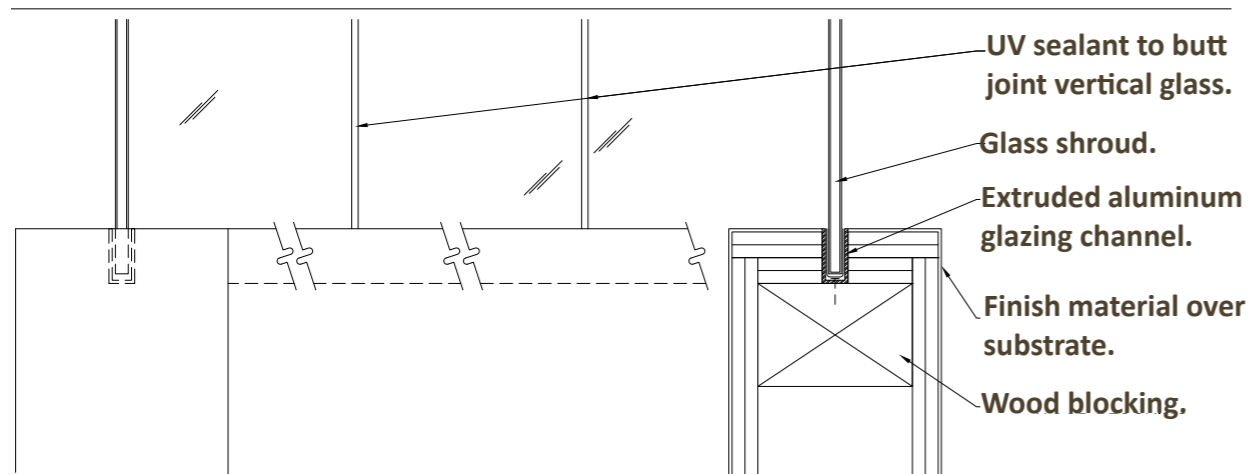

GLASS SHROUD DETAIL

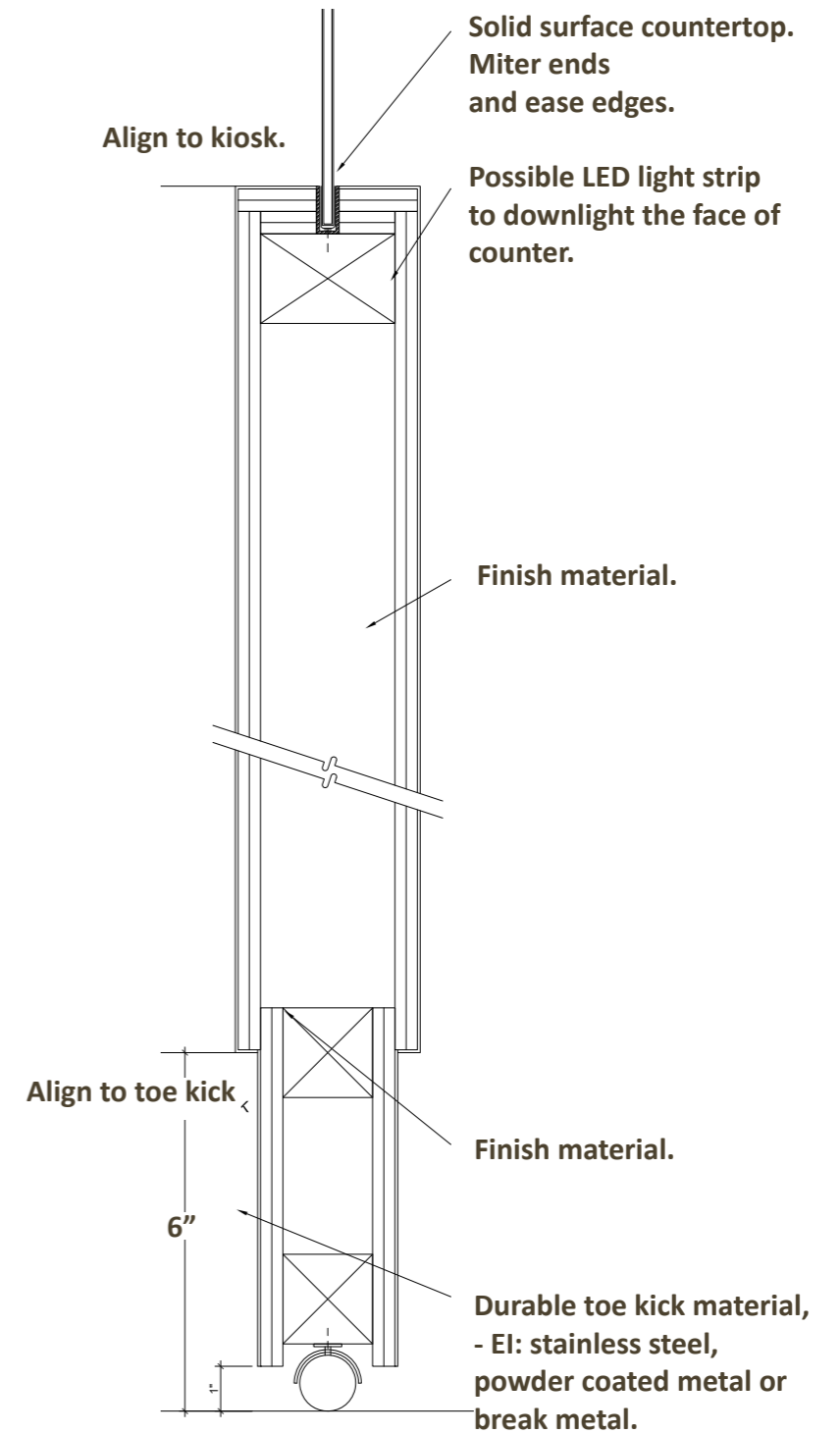

GATE DETAIL

> CORNER / GRAPHIC FRAME

NOTE: CAN BE USED FOR VERTICAL CORNER ONLY

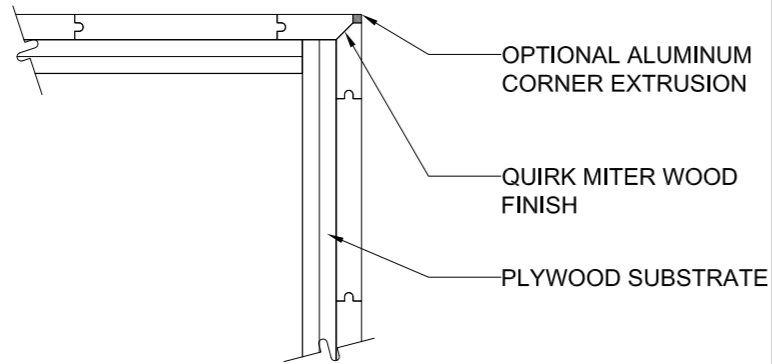

CORNER DETAIL

SCALE	1
HALF SIZE	

NOTE: CAN BE USED FOR VERTICAL CORNER ONLY

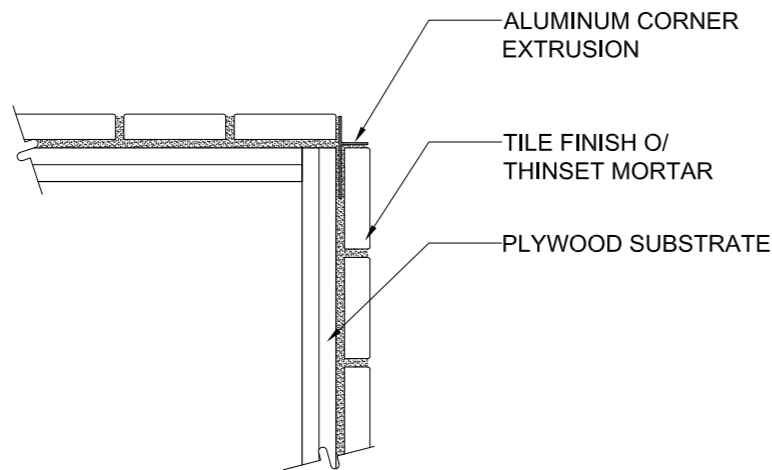

CORNER DETAIL

SCALE	1
HALF SIZE	

NOTE: FOR INTERCHANGEABLE FRAMELESS GRAPHIC PANEL, CHANGE GRAPHICS FROM BACK BY DOING CONCEALED HINGES AND REVEAL DETAILS, USE FOR BACK LIGHT PANELS AS WELL FOR EASY ACCESS IN REPLACING LIGHTS, USE CONCEALED/MAGNET ACTIVATED LOCKS TO SECURE DOOR

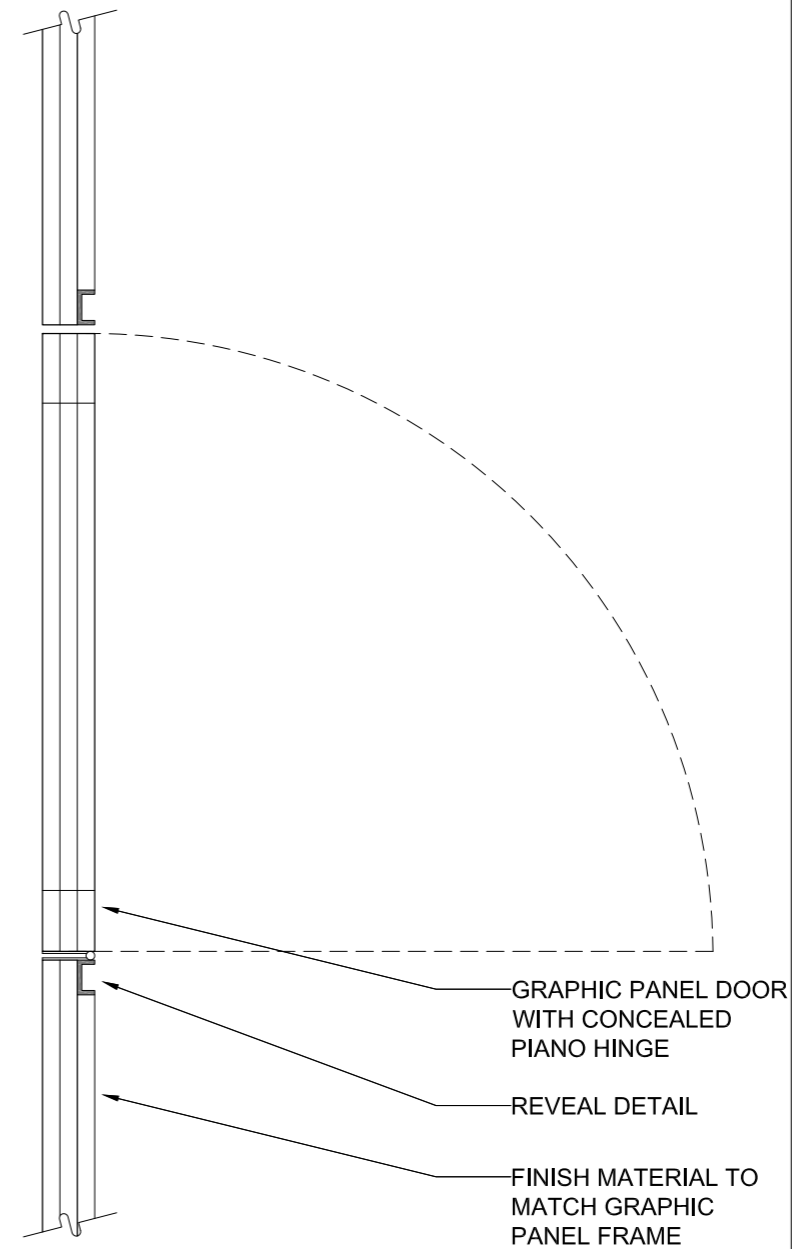

GRAPHIC FRAME

SCALE	1
HALF SIZE	

MALL ZONES > OVERVIEW MAP

This section provides storefront design details, requirements, and visual references specific to the primary zones located within Tysons Corner Center. These are additional design requirements that must be followed to ensure your store correctly interfaces with the immediate surroundings. Click or tap on a colored Zone to navigate directly to that Zone's details.



Click or tap on a colored Zone to view that Zone's construction details.

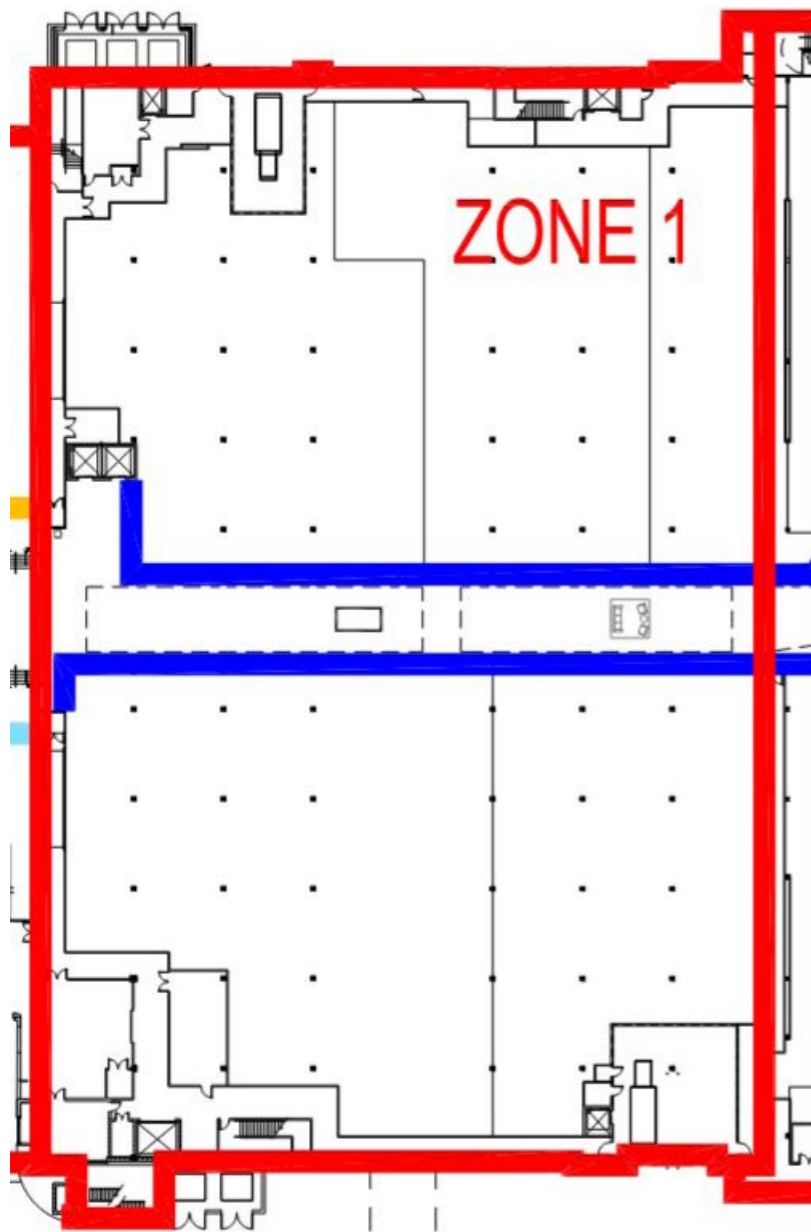

6" or 8" 'C' Channel (Typical)

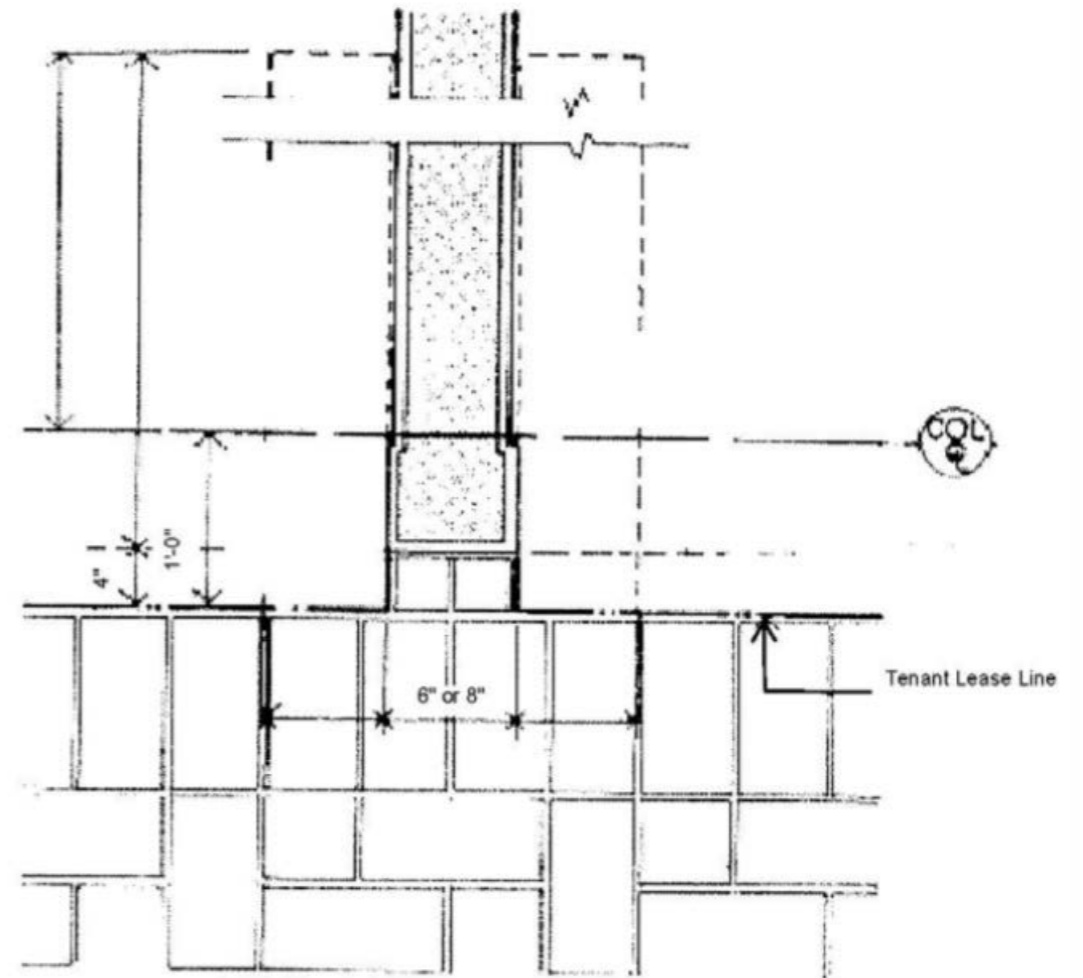

ZONE 1 REQUIREMENTS

- Neutral Pier design shall include a 6" C channel.
 Extend storefront up to 14'-0" or to ceiling above store, whichever is lower.



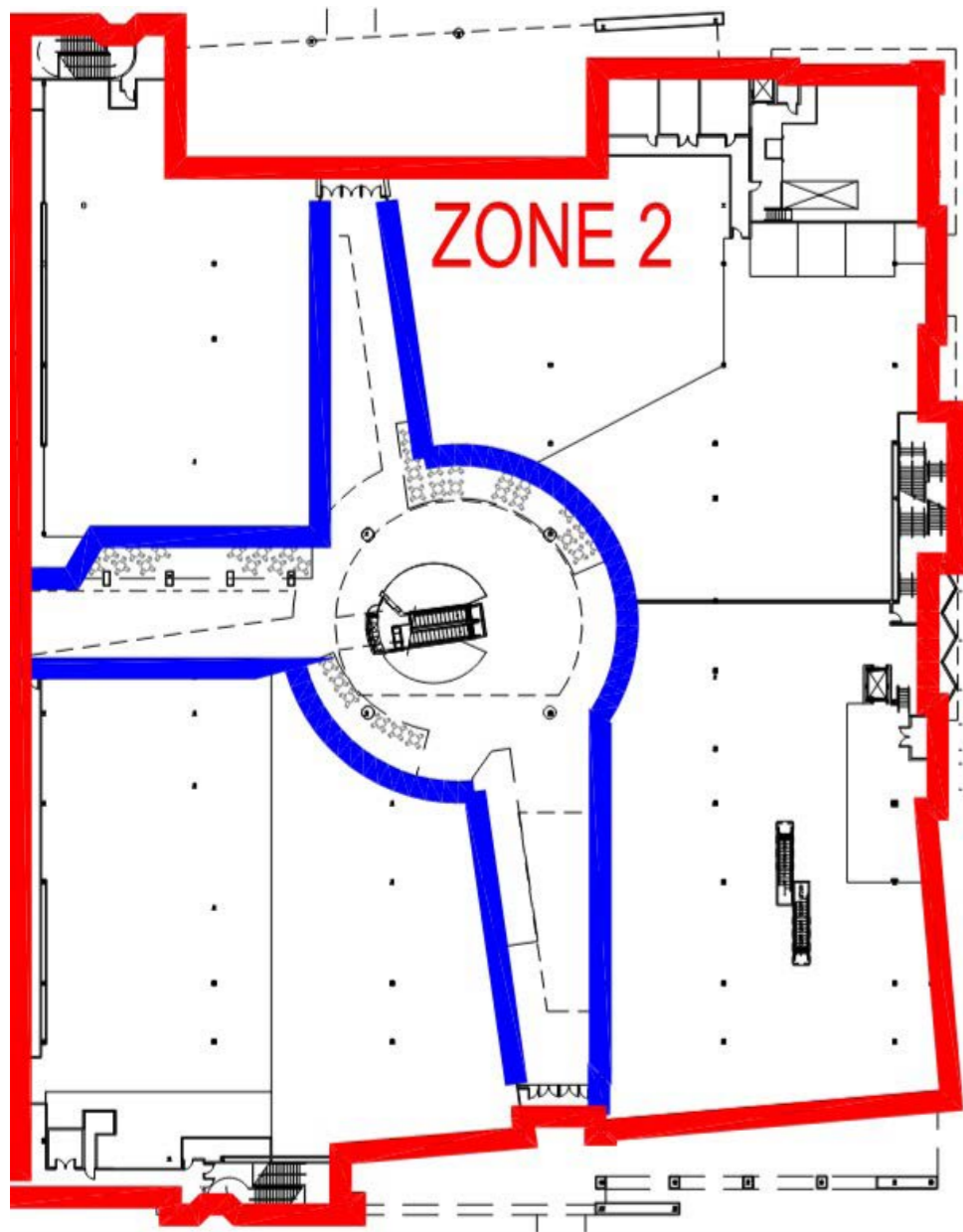

6" or 8" 'C' Channel (Typical)

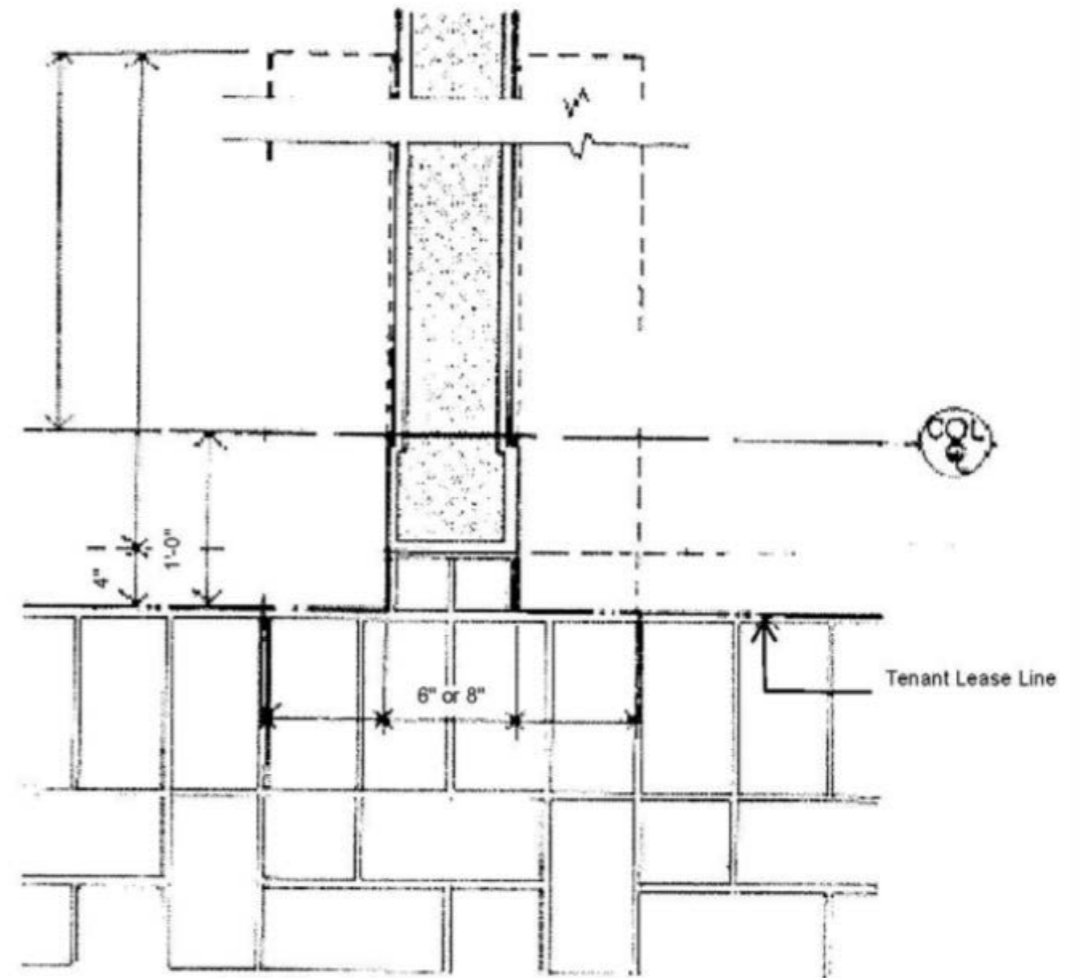

ZONE 2 REQUIREMENTS

- Neutral Pier design shall include a 6" C channel.
 Extend storefront up to 14'-0" or to ceiling above store, whichever is lower.



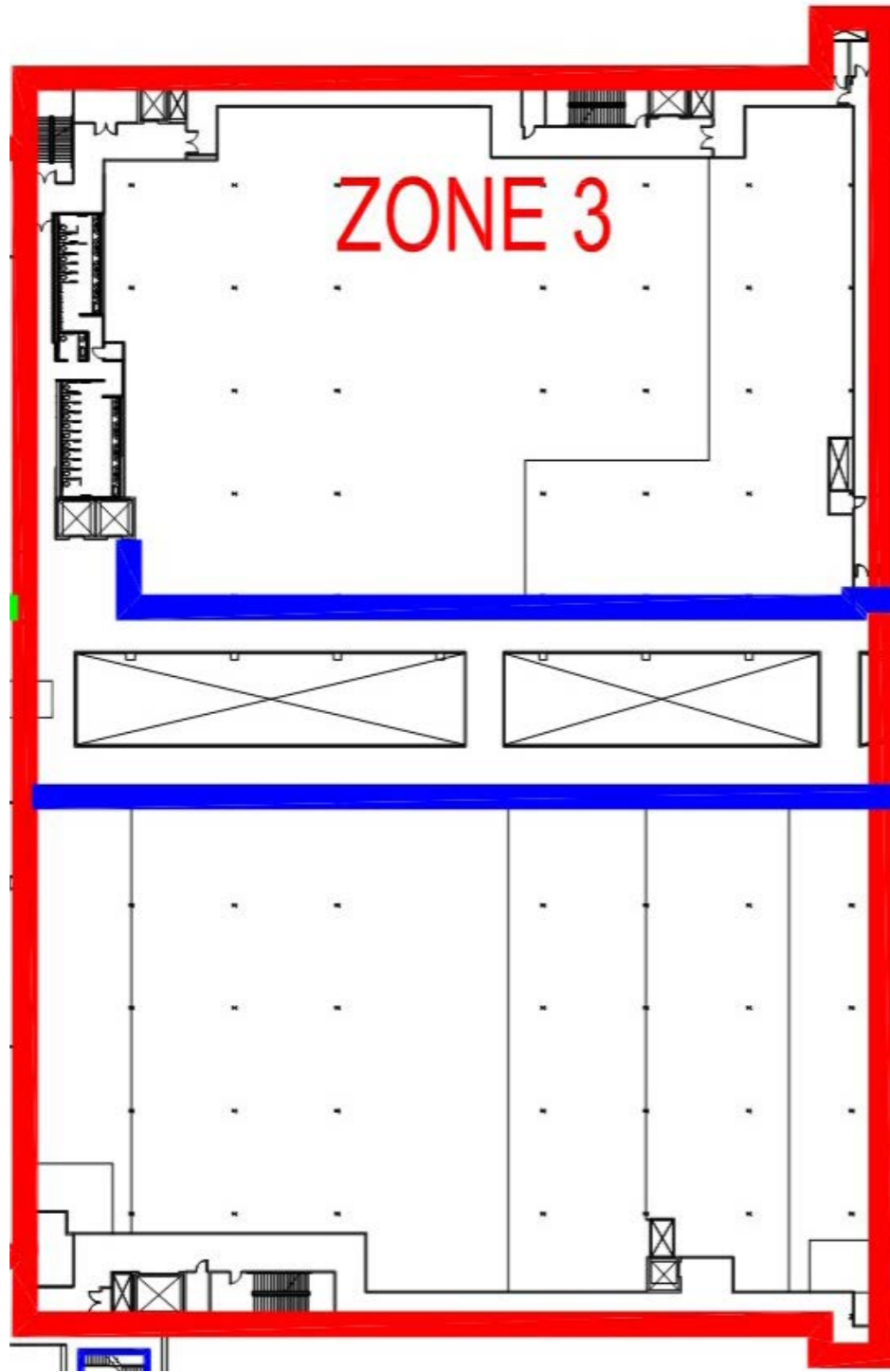

ZONE 3 REQUIREMENTS

- Neutral Pier design shall include a 6" C channel. Extend storefront up to 13'-6".

6" or 8" 'C' Channel (Typical)

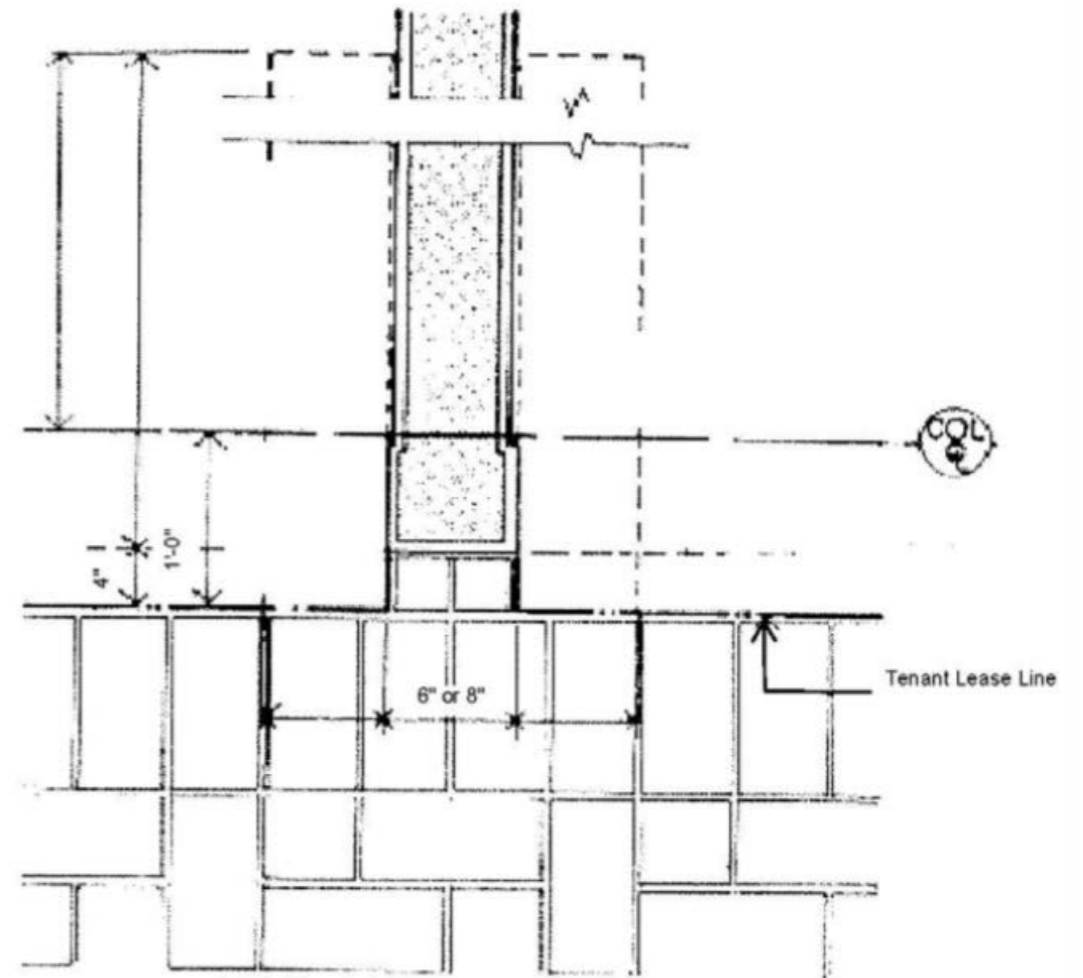

6" or 8" 'C' Channel (Typical)

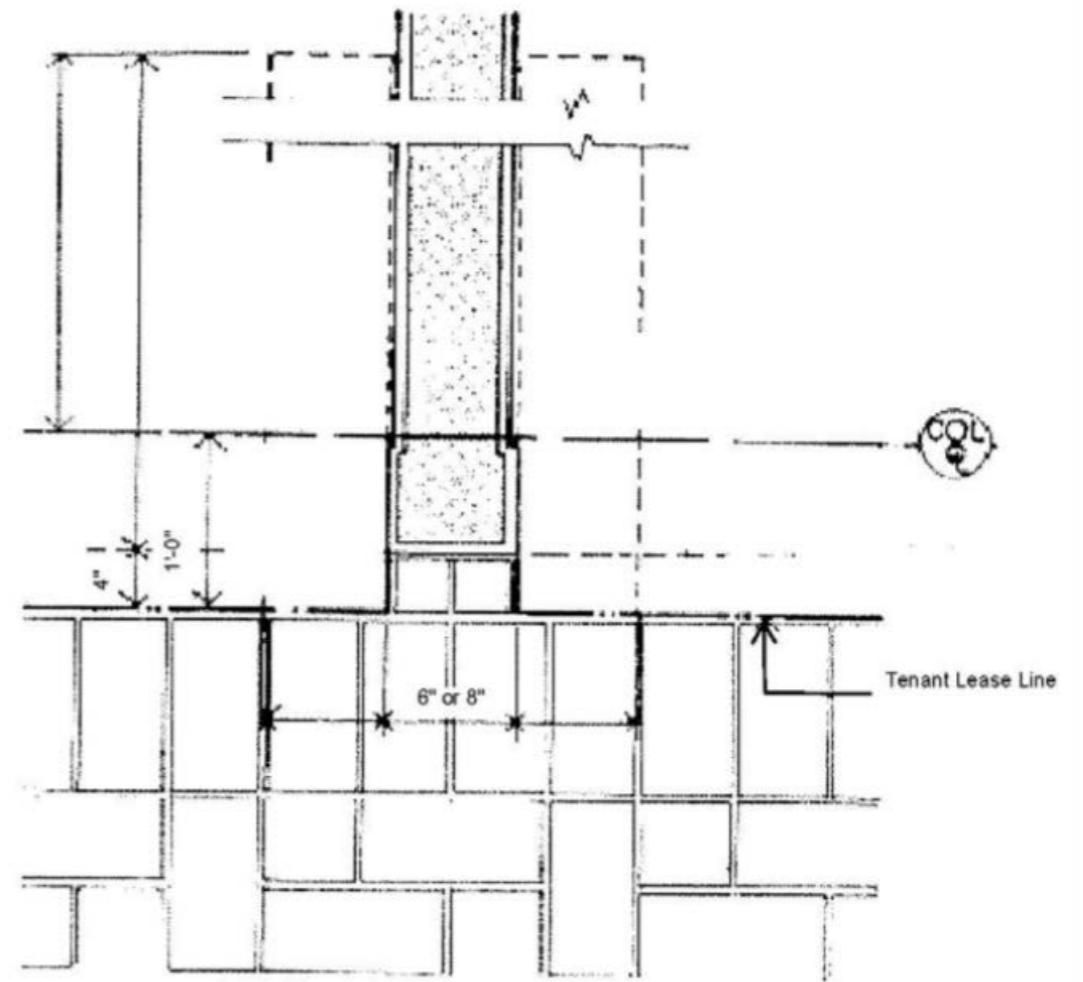
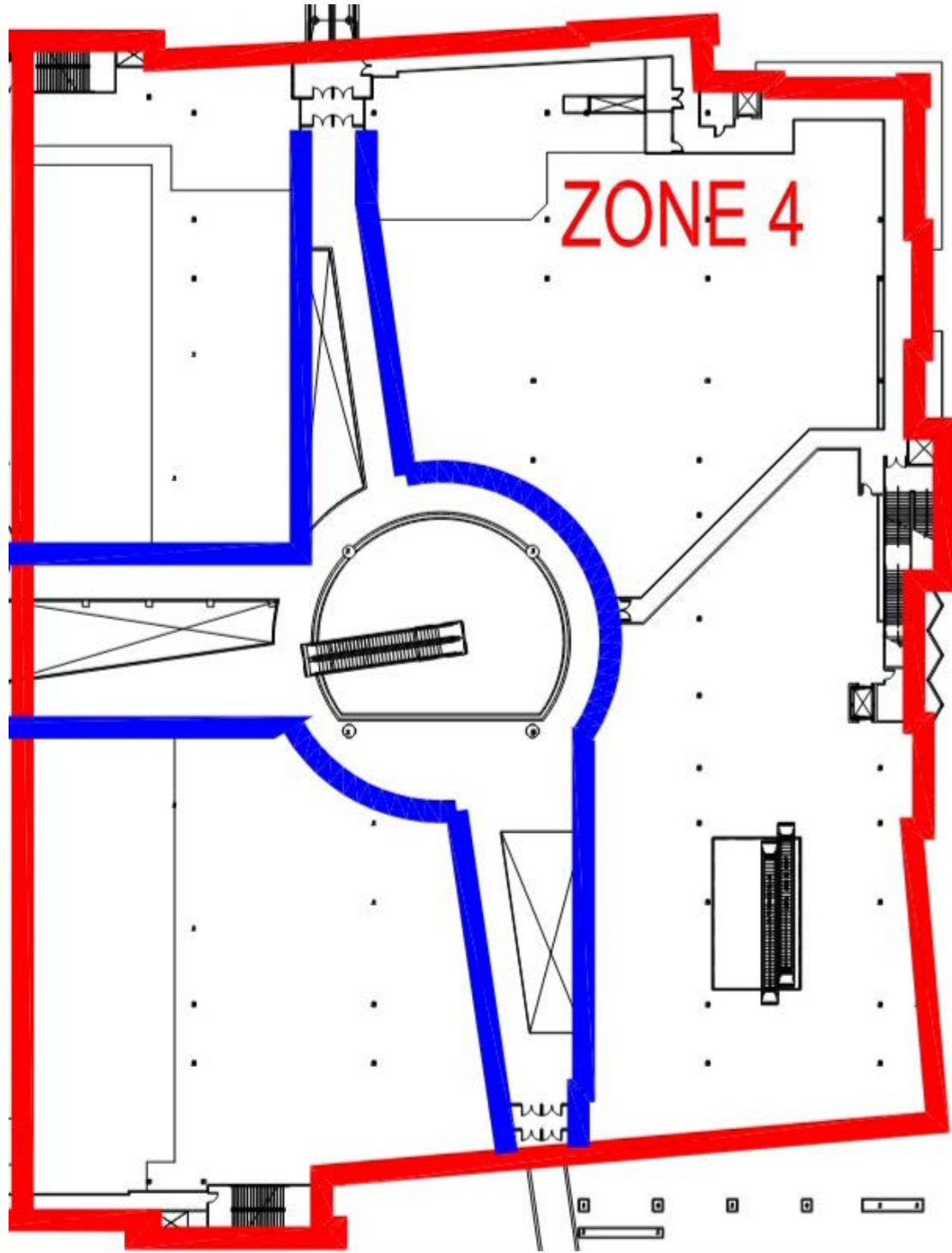

ZONE 4 REQUIREMENTS

- Neutral Pier design shall include a 6" C channel.
Extend storefront up to 13'-6".



REFER TO NO DIG ZONE 4 EXHIBIT

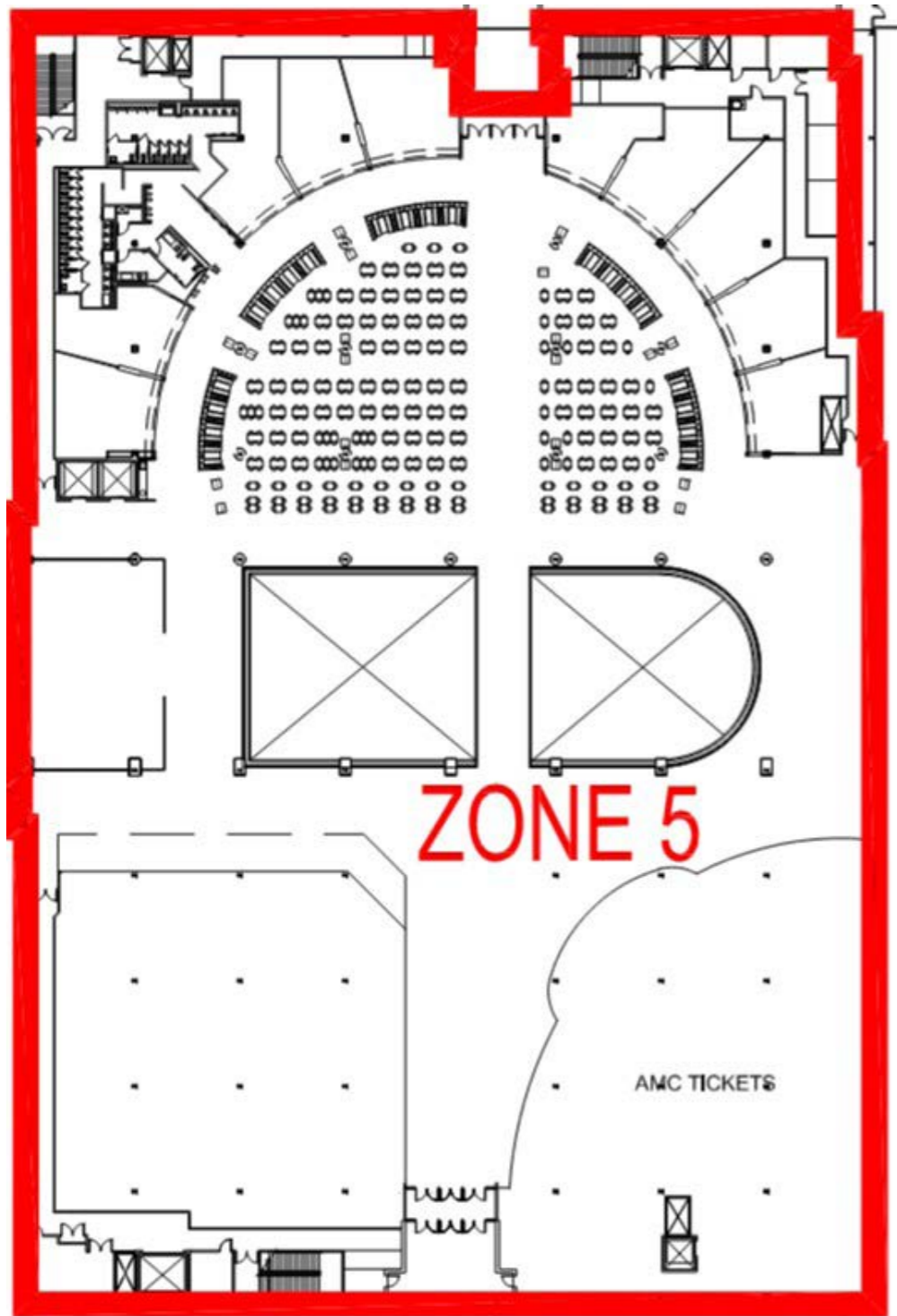

ZONE 5 REQUIREMENTS

Zone 5 is the Food Court. Specific design requirements can be found in the [FOOD CRITERIA](#) Section.



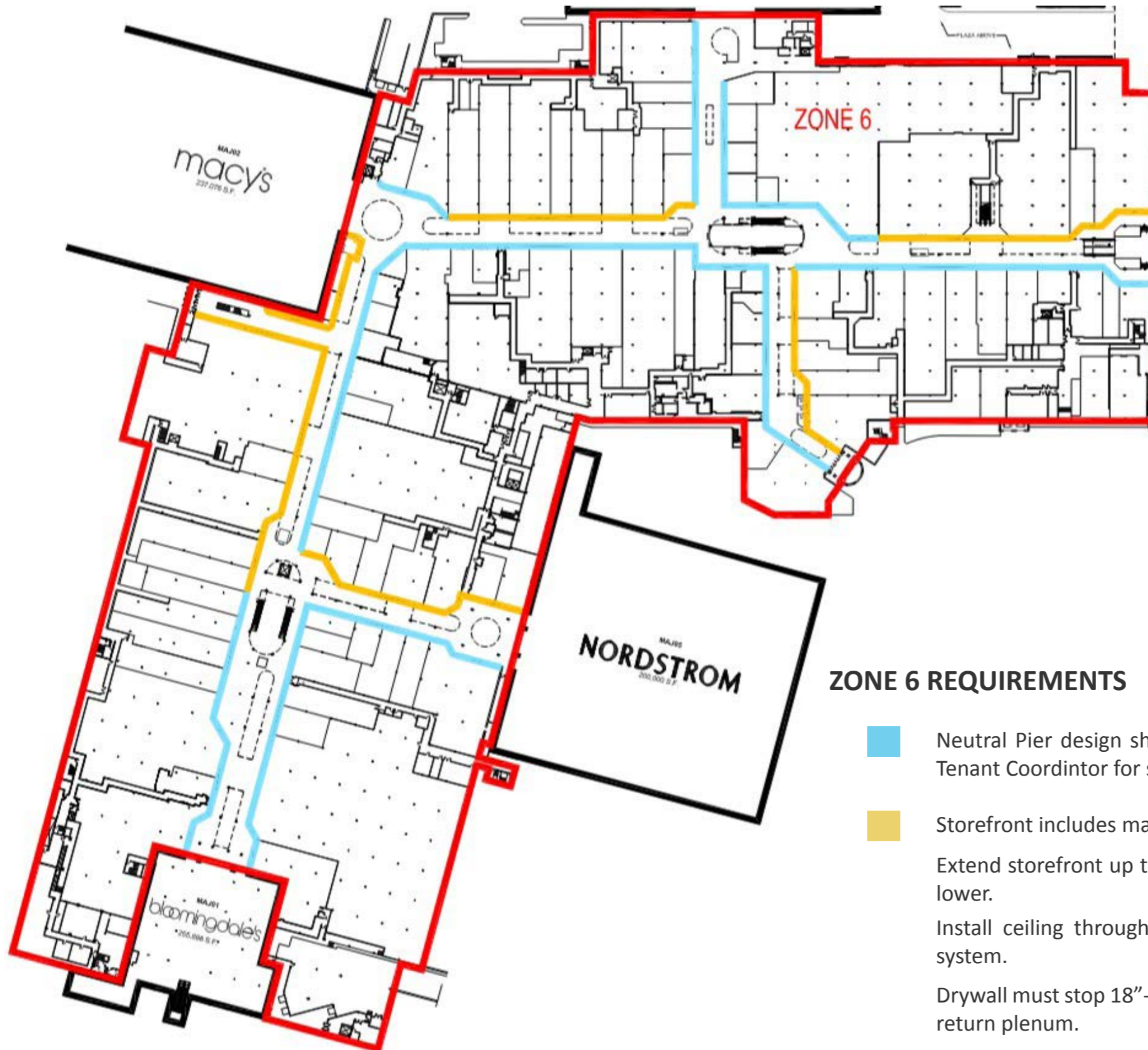

ZONE 6 REQUIREMENTS

- Neutral Pier design shall include a 6" or 8" C channel. Consult the Tenant Coordinator for specific conditions.
- Storefront includes mall feature column as detailed on the next page. Extend storefront up to 14'-0" or to ceiling above store, whichever is lower. Install ceiling throughout space to account for the plenum return system. Drywall must stop 18"-24" below the deck above to maintain the HVAC return plenum.

Mall Feature Column (Typical)

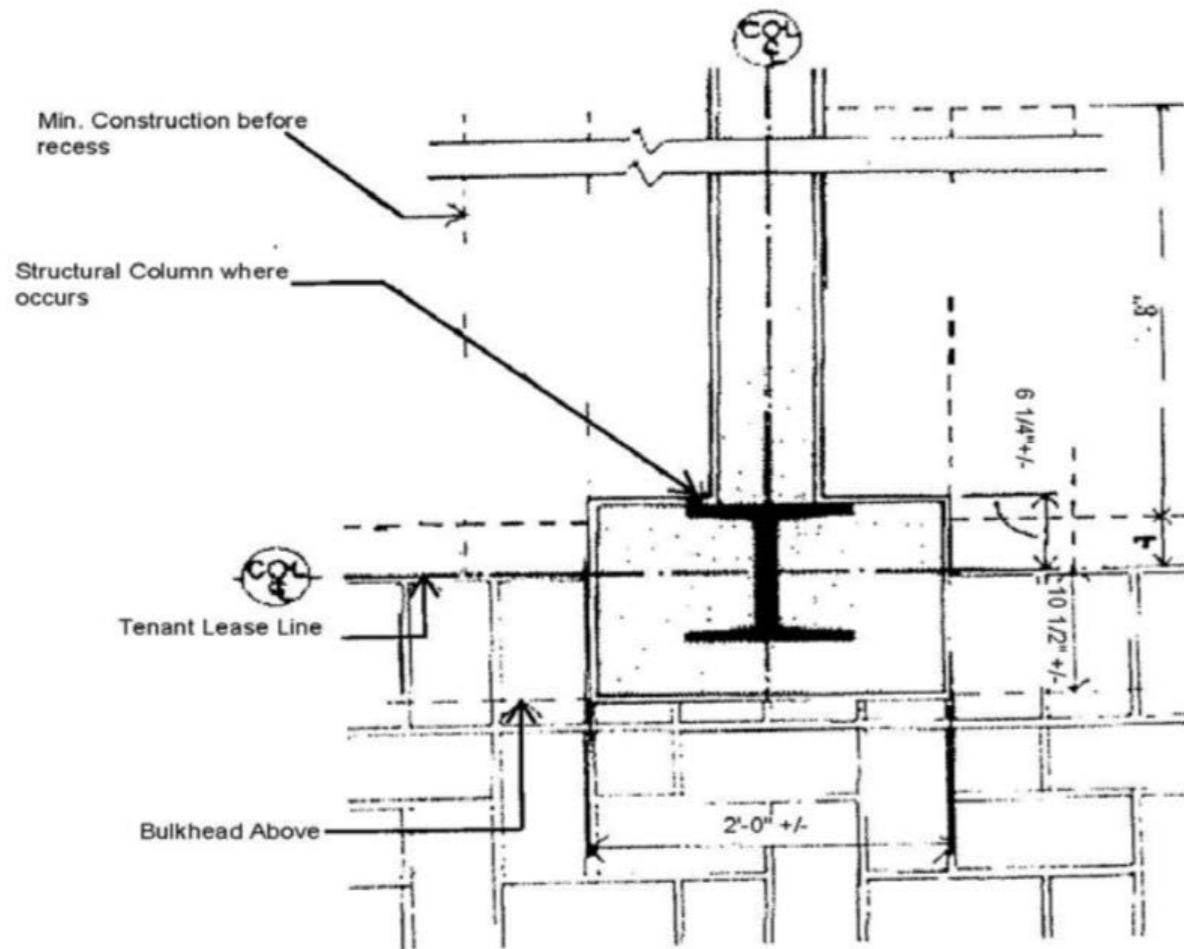

6" or 8" 'C' Channel (Typical)

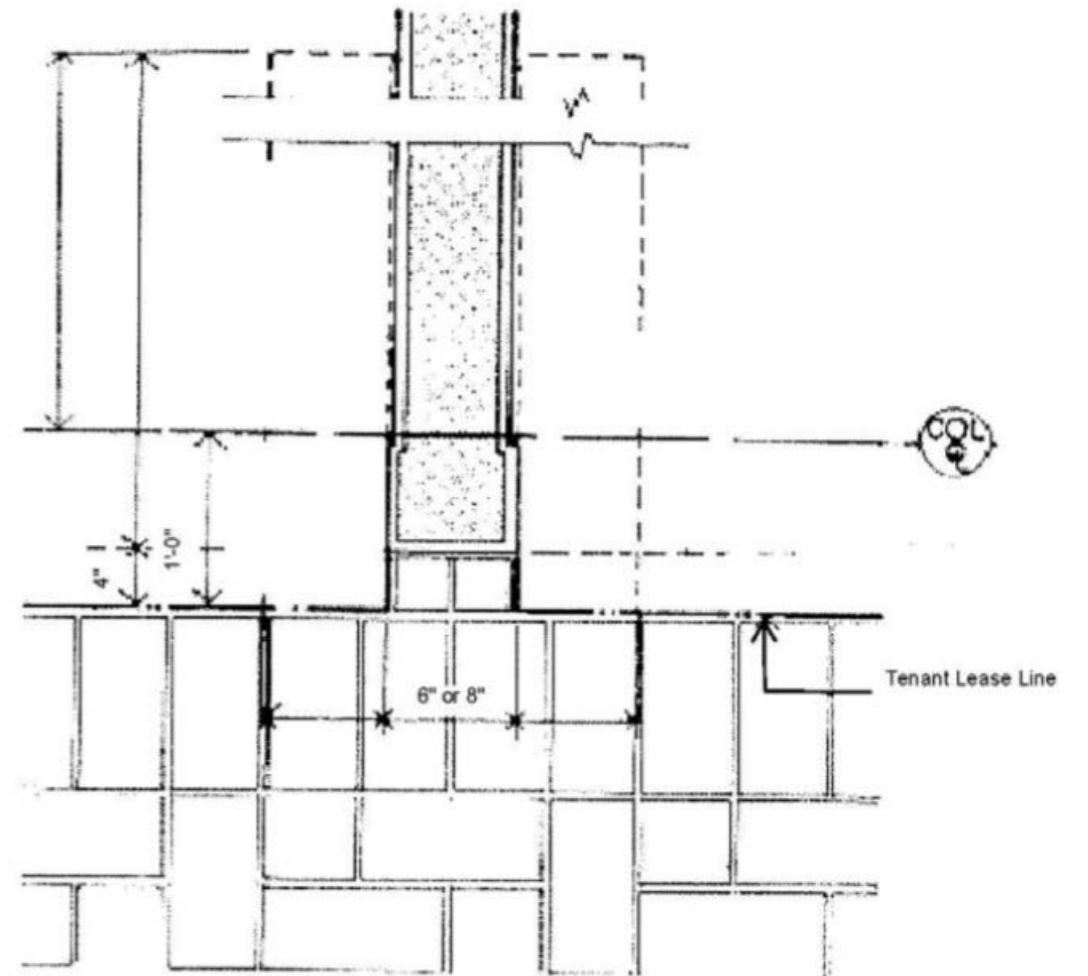

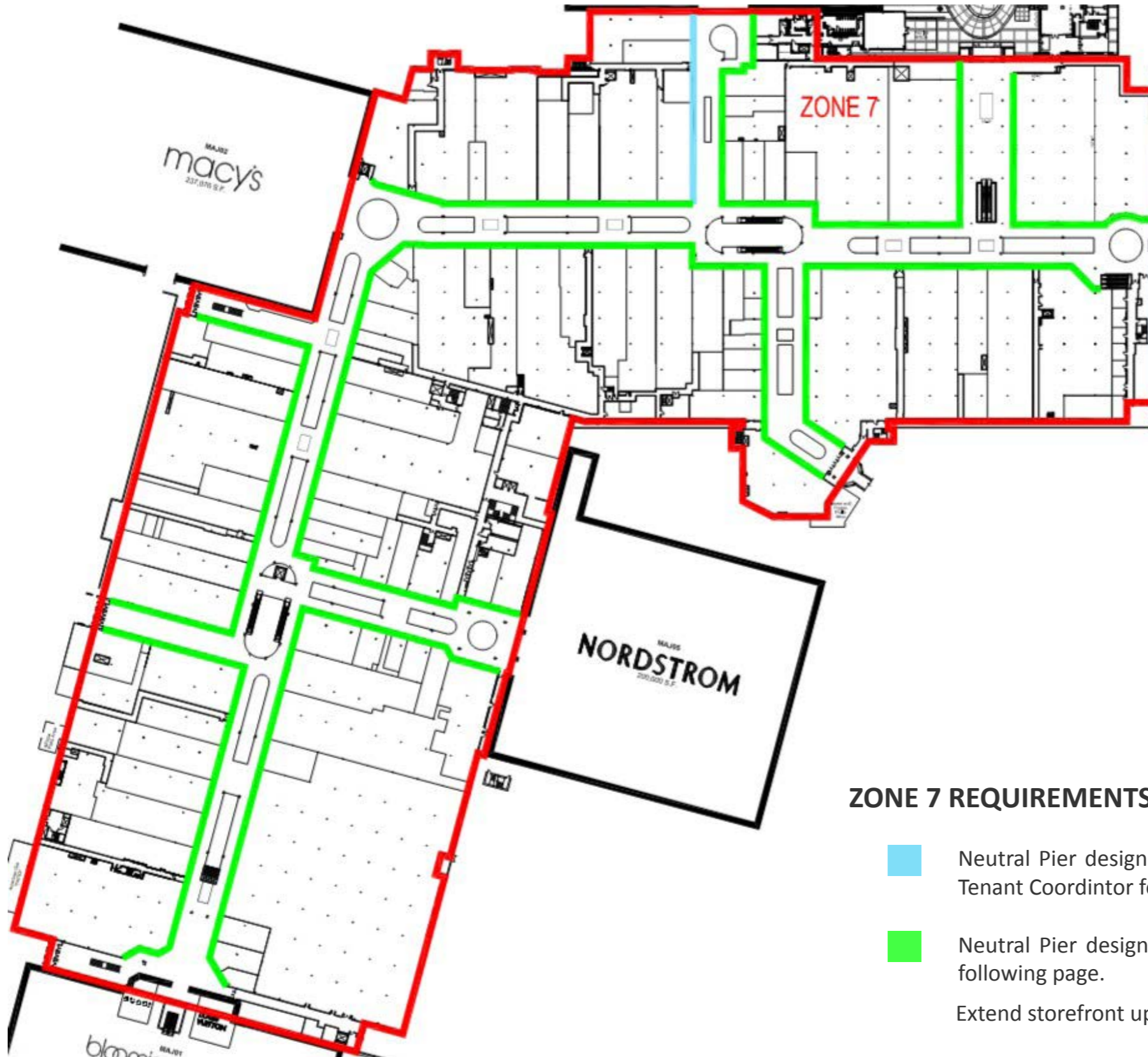

ZONE 7 REQUIREMENTS

- Neutral Pier design shall include a 6" or 8" C channel. Consult the Tenant Coordinator for specific conditions.
- Neutral Pier design shall include a 8" C channel as detailed on the following page.
 Extend storefront up to 13'-6".

6" or 8" 'C' Channel (Typical)

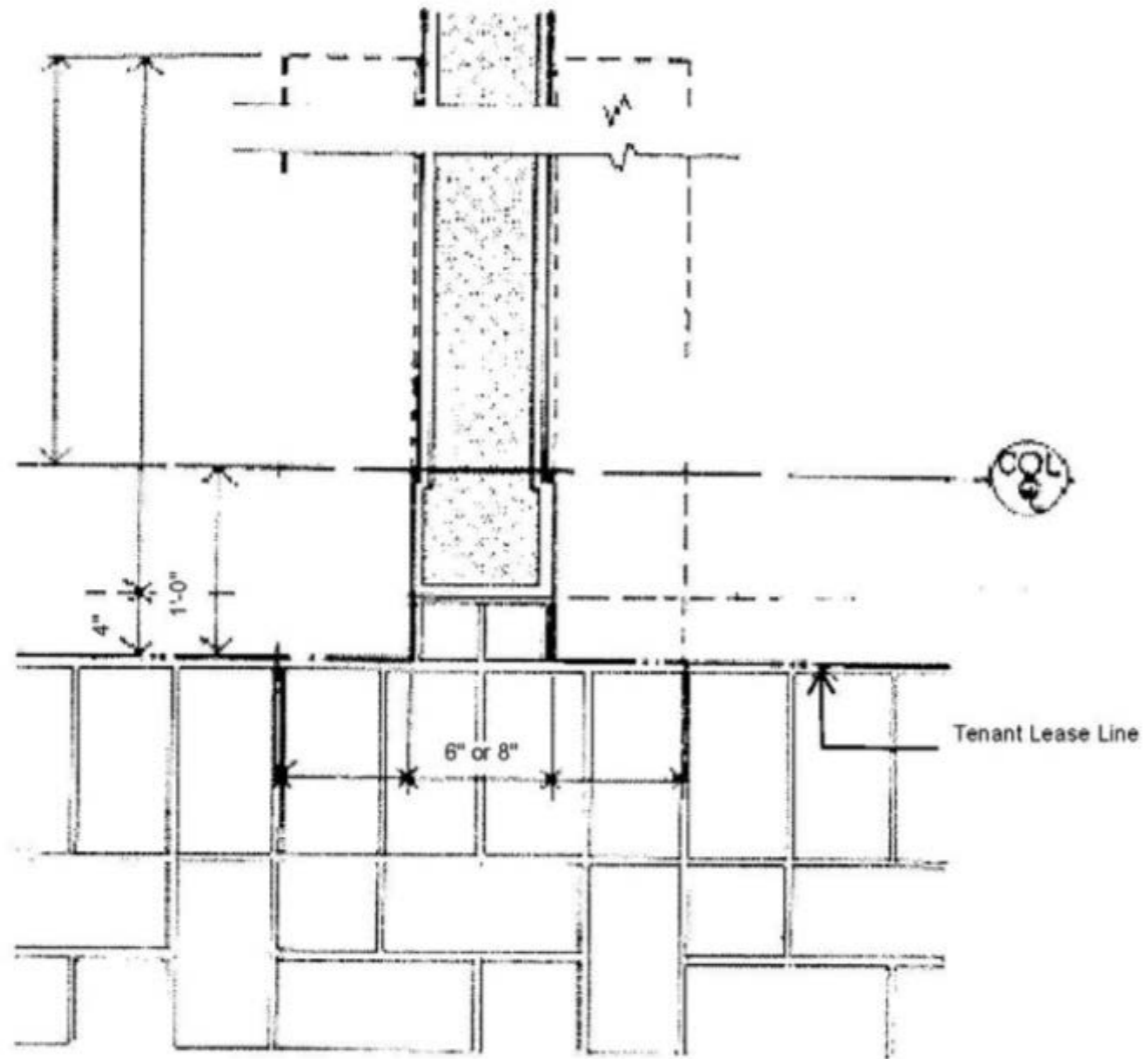

CONTENT OVERVIEW

5.1

VISUAL CONCEPTS

GUIDE TO DIFFERENT AESTHETIC CONCEPT ENCOURAGING VIBRANT STORE DESIGNS.

5.2

KEY DESIGN ELEMENTS

OVERVIEW OF THE CORE DESIGN ELEMENTS TO EMBRACE WHEN CREATING AN ENLIVENING RETAIL EXPERIENCE.

The vibrant character of great shopping destinations is comprised of exceptional storefronts with texture, color, lighting, graphics and merchandising enlivening the pedestrian experience.

Tenants are encouraged to express their individuality and their brand identity through excellent design by forward thinking design teams.



> OVERVIEW

- ARTISAN
- URBAN
- WHIMSICAL
- INVITING
- ARTSY
- THEATRICAL

This section highlights six design concepts encouraged by Macerich for Tenant's looking for additional store design inspiration. Our design team welcomes Tenants to engage in these concepts and invites open collaboration in an effort to create store designs that enhance the retail experience.

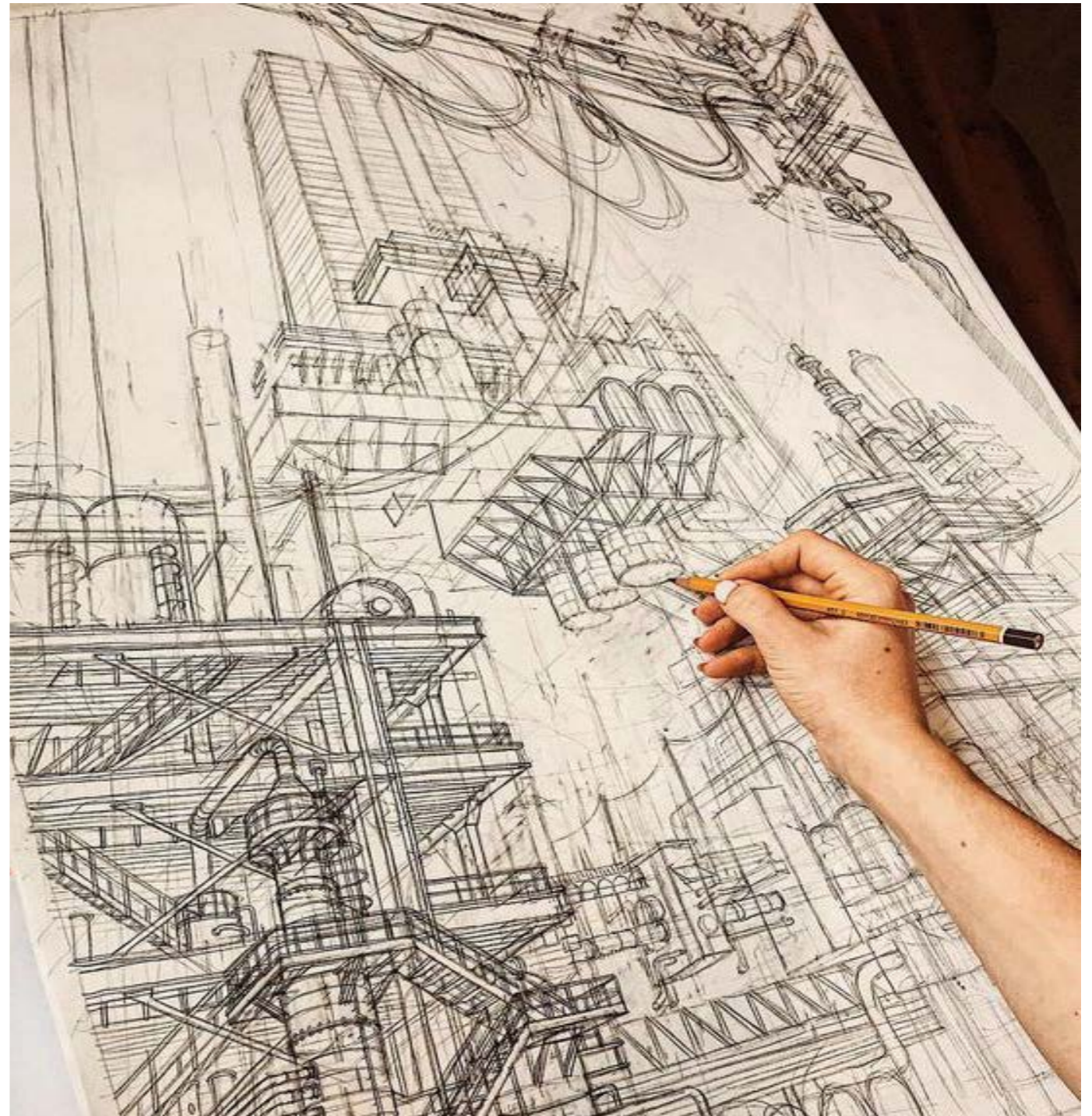

> ARTISAN

ARTISAN

NATURAL, SOPHISTICATED, UNIQUE



> URBAN

URBAN

EDGY, FUNKY, STREET SAVVY STYLE, INDUSTRIAL

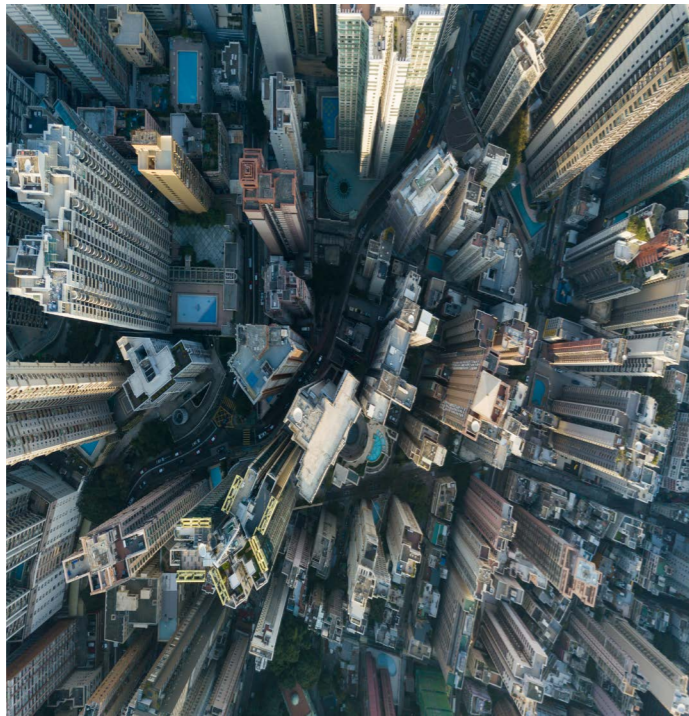

> WHIMSICAL

WHIMSICAL

UNEXPECTED, PLAYFUL, COLORFUL



> INVITING

INVITING
WARM, CALM, OPEN, SOFT



> ARTSY

ARTSY

QUIRKY, AVANT GARDE, SURPRISING



> THEATRICAL

T H E A T R I C A L
DRAMATIC, HIGH CONTRAST, MOVEMENT



KEY DESIGN ELEMENTS > BRANDING / VISUAL MERCHANDISING

Macerich embraces four key design elements to engage customers and encourage store traffic and sales. Strong use of textures, colors, lighting, graphics, and merchandising in these elements help draw customers and inviven the pedestrian experience.

BRANDING

A brand is a name, term, design, symbol, color or some other feature that identifies a seller's product or services as distinct from those of other seller's.

Your branding can be communicated with signage, graphics, materials, shapes, colors, textures, patterns and the overall look and feel of your kiosk, to tell a story and create a lasting experience.



VISUAL MERCHANDISING

Strong visual presentation and merchandising are essential and integral components of retail design.

- Attempt to create triangular composition within style groups or color groups. (display in groups of three or five).
- Start with a center feature, (best sellers and hot items), and merchandise out symmetrically or asymmetrically in a balanced manner.



KEY DESIGN ELEMENTS > LAYERING / TECH AND MEDIA

LAYERING

How can you make a wall / elevation into a canvas for communication to the customer as they walk towards or by your store?

- Incorporating patterns and textures.
- Overlaying materials to create dimensionality.
- Molding shapes to create softness.
- Overlapping to create shadows and depth.



TECHNOLOGY AND MEDIA

Technology can enhance your on line operation by transforming your retail space into a multifunctional one, that lends itself to being an in store pick up location, payment booth or advertising billboard.

Integrating technology into your store design can:

- Become an extension of you.
- Supplement your salesforce with interactive screens for ordering, design yourself functions and more.
- Keep your business connected with your customer.
- Help you tell a story.
- Help make menu boards easier to update and better communicate your offerings to your customer via LCD screen loops.

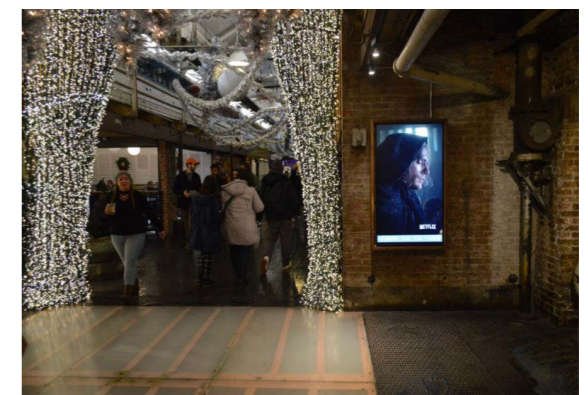

PROPERTY INFO CONTENT OVERVIEW

6.1 ADDRESS & HOURS

LOCATION AND SCHEDULE INFORMATION.

6.2 SITE PLAN

OVERVIEW MAP OF CENTER.

6.3 CONTACTS

MALL CONTACTS, REQUIRED CONTRACTORS, LOCAL MUNICIPALITIES, AND UTILITY CONTACT INFO.

6.4 CODES AND PERMITTING

OVERVIEW OF BUILDING CODE, CLASSIFICATIONS, AND LOCAL PERMITTING.

6.5 OPERATIONS AND UTILITIES

OVERVIEW OF CENTER OPERATIONS AND TYPICALLY AVAILABLE UTILITIES.

6.6 CONSTRUCTION

OVERVIEW OF CONSTRUCTION PROCEDURES.

SECTIONS OF INTEREST

The following sections provide additional details and requirements related to this Criteria:

ADDENDUM

Provides additional construction requirements to contractors.

The Property Info Criteria provides an overview of the Center's building classification, contacts, local permitting, and typically provided utilities.

It is important to note that the Contacts section includes the Center's required contractors. These contractors **must** be used during the design and buildout of your store.



ADDRESS AND HOURS

Tysons Corner Center is located at a major interection between Interstate 495, Chain Bridge Rd., and Leenbug Pike in Tysons Corner, VA. The Center is open 7 days a week. Open hours for individual restaurants and entertainment venues may vary.

Center Address

1961 Chain Bridge Road, Suite 105
Tysons Corner, VA 22102

Center Hours

Monday - Saturday: 10:00 AM to 9:30 PM
Sunday: 11:00 AM to 7:00 PM

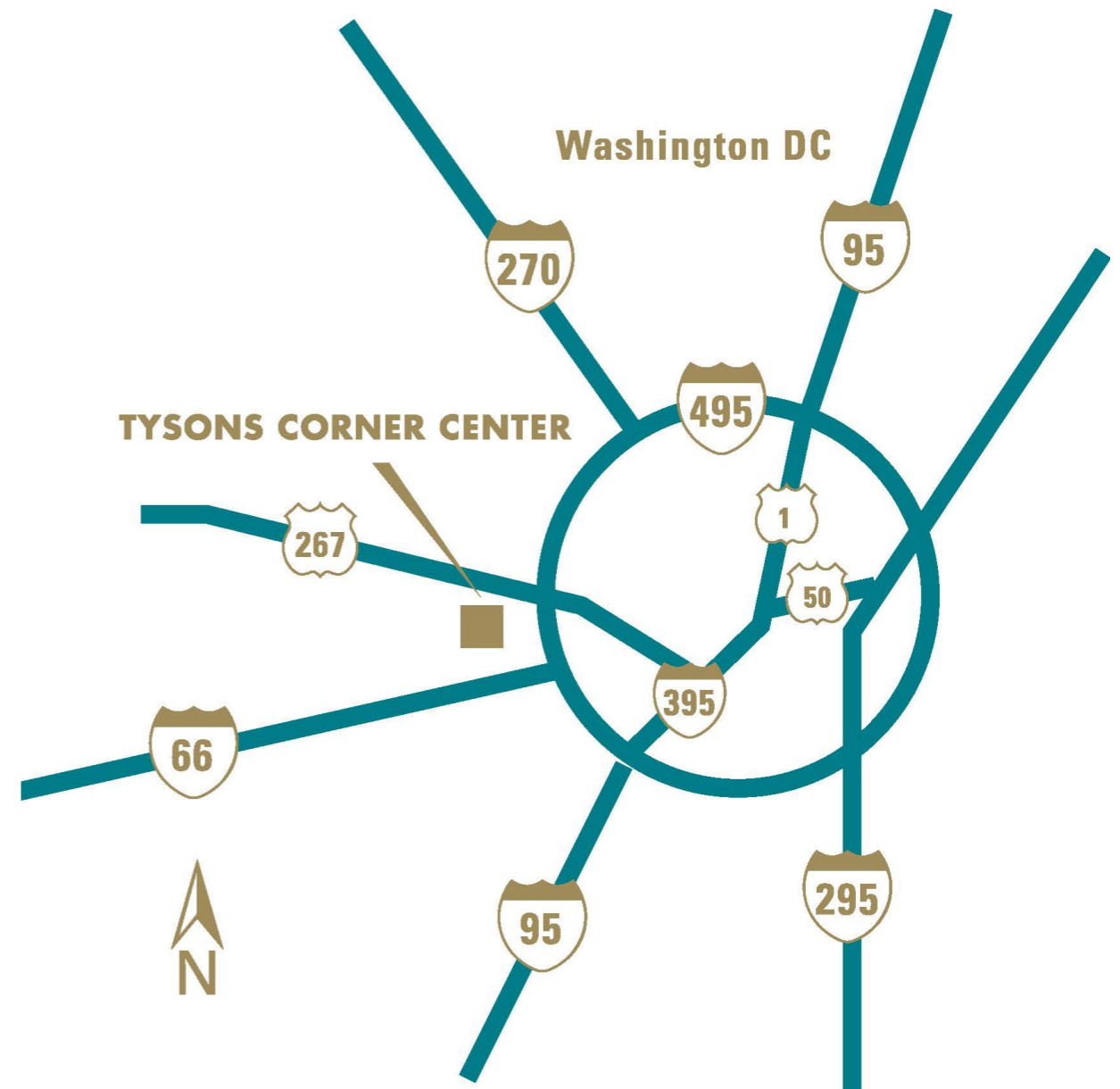

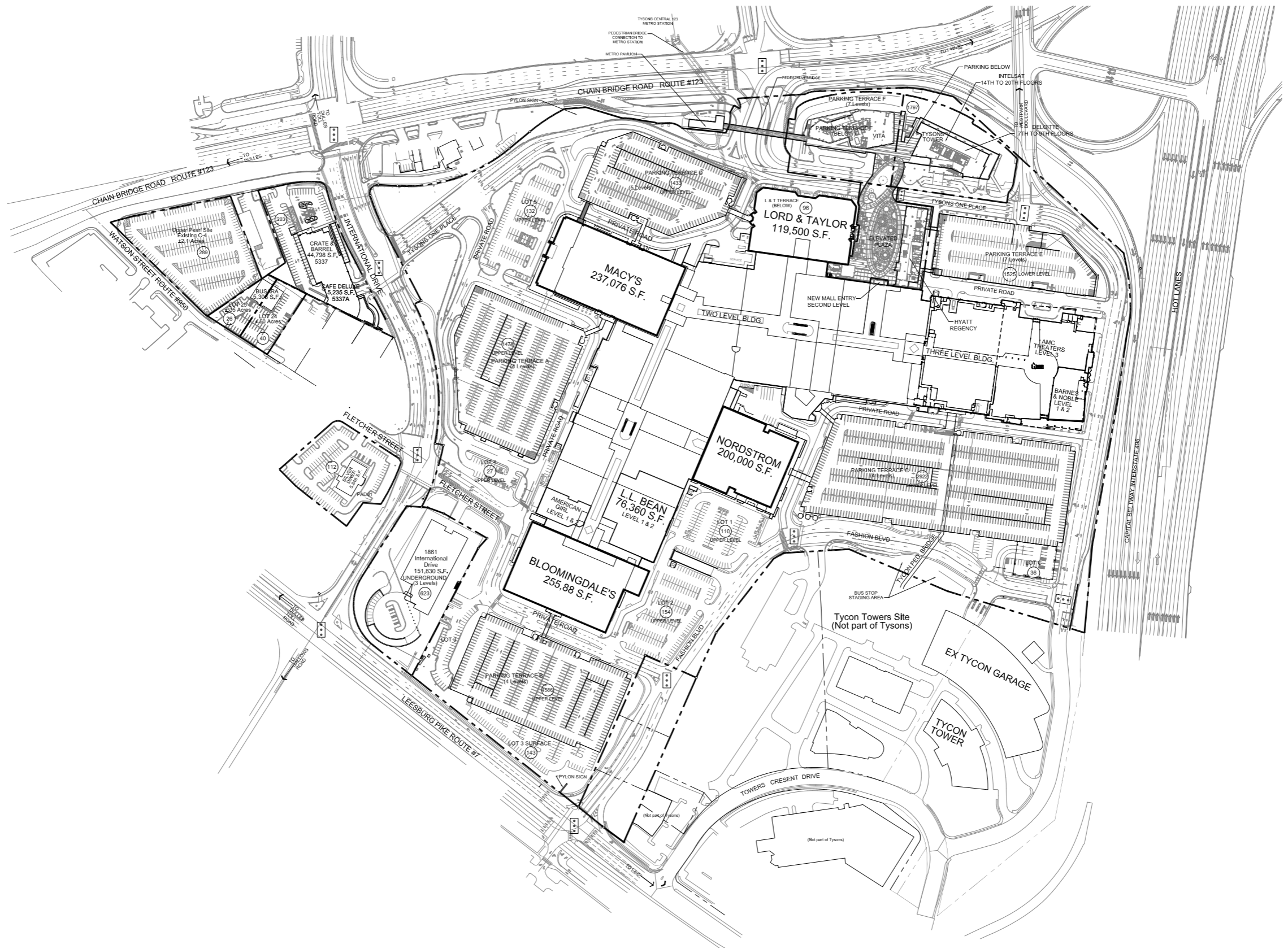

> PROPERTY TEAM / UTILITIES / LOCAL AGENCIES

PROPERTY TEAM

The following points of contacts are available to discuss site details and procedures. The primary point of contact for inquiries is the Tenant Coordinator.

SENIOR OPERATIONS MANAGER

Kevin Marroquin

Phone: (703) 893-9401

kevin.marroquin@macerich.com

ASSISTANT MANAGER, OPERATIONS

Mike Mudd

Phone: (703) 893-9401

(301) 503-8175

mike.mudd@macerich.com

TENANT COORDINATION

Ryan Nauman

Phone: (571) 271-7705

ryan.nauman@macerich.com

Greg Wojcik

Phone: (585) 249-4440

greg.wojcik@macerich.com

LEASING

Hillary Muss

Phone: (212) 405-8804

hillary.muss@macerich.com

MARKETING

Lindsay Petak

Phone: (703) 770-1143

lindsay.petak@macerich.com

LANDLORD/OWNER

The MACERICH Company

401 Wilshire Blvd., Suite 700

Santa Monica, CA 90401

UTILITIES

The following points of contacts are the utility companies necessary to interface with to set up utility accounts:

DATA

*Data is required to be set up through Granite Grid. Other service providers do not have a Right of Entry agreement and are not permitted. **It is highly recommended to coordinate service install a minimum of 4 weeks in advance.*

Rob Norton

Phone: (781) 884-5545

rnorton@granitenet.com

GAS

Gas utility is only available for food use. Gas is not available for heating.

Washington Gas

6801 Industrial Road

Richmond, VA 22151

Phone: (703) 750-4584

CABLE TV

Tyson's Corner Center is not wired for Cable TV. Tenant must provide their own service and coordinate with Mall Operations.

LOCAL AGENCIES

The following points of contacts are the local agencies responsible for plan reviews and inspections:

BUILDING PERMITS

Fairfax County Department of Environmental Management

12055 Government Center Parkway

Fairfax, VA 22035

Phone: (703) 324-1645

www.co.fairfax.va.us/gov/gov/dem/

FAIRFAX FIRE AND RESCUE

www.co.fairfax.va.us/ps/fr/homepage.htm

Fire Alarm Permits

Phone: (703) 246-4821

Sprinkler Permits

Phone: (703) 246-4821

HEALTH DEPARTMENT

Fairfax County Health Department

10777 Main Street, Suite 111

Fairfax, VA 22030-6903

Phone: (703) 246-2444

BUILDING AND SAFETY

Dept. of Public Works and Environmental Services

12055 Government Center Parkway

Fairfax, VA 22035

Phone: (703) 324-1060

OFFICE OF THE FIRE MARSHAL

County of Fairfax Fire Marshal

10700 Page Avenue

Fairfax, VA 22030

Phone: (703) 246-4800

BUSINESS LICENSING

Fairfax County Business Experience Program

12000 Government Center Pkwy

Fairfax, VA 22035

Phone: (703) 324-2694

LIQUOR LICENSING

Department of Alcoholic Beverage Control

6308 Grovedale Drive

Alexandria, VA 22310

Phone: (703) 313-4432

> REQUIRED CONTRACTORS

REQUIRED CONTRACTORS

The following points of contacts are the required contractors that must perform the construction for their related systems. These contractors are required since they have intimate knowledge of the property building systems and can properly interface Tenant systems with the base building infrastructure.

SPRINKLER CONTRACTORS

Tysons Corner Center allows any of the following Sprinkler contractors to work in the Center:

Summit Fire & Security

Vince Edwards

4230 Lafayette Center Drive, Suite G

Chantilly, VA 20151

Phone: (703)550-9400

www.summitfiresecurity.com

VSC Fire & Security

Paul Martin

7708 Fullerton Road

Springfield, VA 22153

Phone: (703) 584-2200

pmmartin@vscfs.com

Freedom Fire Protection, LLC

John Perlow

3510 Mountain Road

Haymarket, VA 20169

Phone: (703) 754-2445

john@freedomfireprotectionllc.com

SimplexGrinnell

22712 Commerce Center Court, Suite 114

Dulles, VA 20166

Phone: (703) 996-0728

FIRE ALARM CONTRACTOR

Haislip Corporation

John Haislip

14325-F Willard Rd.

Chantilly, VA 20151

Phone: (703) 930-0943

john@haislipcorp.com

DATA PROVIDER AND LOW VOLTAGE

Rob Norton

Granite Telecommunications

Phone: (781) 884-5545

rnorton@granitenet.com

ROOFING CONTRACTOR

Function Enterprises

7954 Cameron Brown Court

Springfield, VA 22153

Phone: (703) 569-2422

BARRICADES

Boston Barricade

Chris Danielson

Phone: (772) 766-2527

cdanielson@bostonrs.com

ENERGY MANAGEMENT

WE Bowers

Tim Penatzer

Phone: (571) 383-7657

tpenatzer@webowers.com

ENGINEER OF RECORD

RTKL

901 South Bond Street

Baltimore, MD 21231

Phone: (410) 537-6060

GREASE WASTE

Keter Environmental Services

Yani Ferreira, Regional Manager

Cell: (317) 935-7075

yferreira@keteres.com

www.keteres.com

BUILDING CODE OVERVIEW

Tysons Corner Center offers spaces for retail, restaurants, and entertainment. Below are the pertinent property details related to local building codes. It is the sole responsibility of the Tenant's Architect, Engineers, Consultants, and Contractors to comply with all applicable federal, state, and local codes and ordinances for their occupancy type.

BUILDING TYPE

Two and three-level regional shopping center of approximately 2,300,000 square feet of gross leasable area.

APPROVED OCCUPANCY TYPES

Mercantile (M)

CONSTRUCTION CLASSIFICATION

Covered Mall building of type II-B construction, mercantile, with business, storage.

APPLICABLE CODES

Currently adopted edition of the Uniform Building Code as amended and adopted by Fairfax County, Virginia.

All design and construction work shall comply with all applicable statutes, ordinances, regulations, laws and codes of Fairfax County, Virginia.

It is the sole responsibility of the Tenant's Architect, Engineers, Consultants, and Contractors to comply with all applicable federal, state, and local codes and ordinances for their occupancy type.

CODE CLARIFICATION

In an effort to streamline the building review process for all Tenants in the Tysons Corner Center, The Macerich Company has taken steps with the County of Fairfax to resolve numerous code related issues pertaining to design, permitting, and required inspections at Tysons Corner Center.

Due to the number of code modifications agreed upon, the County Building Officials have requested that all Tenant inquiries be made to the Landlord representatives.

PLEASE DO NOT CONTACT FAIRFAX COUNTY DIRECTLY.

PERMITTING

Tenant construction, signage, and food service all require permitting from the Fairfax County Building Department

I. BUILDING PERMIT

For all construction, prior to work commencement, building and other required permits shall be obtained by the Tenant.

- Tenant's architect must utilize the address provided on the Master Zone and Address Plan, not the space number shown.
 - For example: Space number M1L = "7876L Tysons Corner Center, McLean, VA 22102."
- The Tenant street address must be noted on the Building Permit application and on any County required shop drawings.
- All subcontractors must utilize the same mailing address information for Tenant specific Permits. Please contact the Tenant Coordinator with any questions and mailing address information for Tenant specific permits.
- Tenants who occupy locations on two levels must utilize the lower level address for Building Department submittal. For example: 7851L for combined spaces M13L & M17U.
- Sprinkler/Fire Alarm/Kitchen Range Hood Fire Protection System shop drawings must be submitted to the County. Hydro tests on the sprinkler system, and a mechanical inspection of the kitchen range hood fire protection system must be performed and inspected/passed by Fairfax County Officials as part of the build-out process.

The Fairfax County requires the following documents be included in the submittal package:

- Property Location Map
- Property Site Plan
- Project Key Plan
- A Structural Requirements for Hung Equipment Letter depending on your location as highlighted in the [BUILDING DETAILS](#) section.
- Fairfax County [Permitting links](#).

II. HEALTH DEPARTMENT SUBMITTAL

All restaurant and food court Tenants are advised to contact the Fairfax County Health Department at (703) 246-8468 to discuss specific questions and the information requested on the enclosed "Requirements for Proposed Food Service Facilities" checklist.

OPERATIONS

The following is a brief overview of the site infrastructure available during retail operations and construction.

PARKING

Parking for constructon personnel will be permitted in Landlord designated areas only.

DELIVERIES

Deliveries will be made only through entrances and routes designated by Landlord. Landlord will establish delivery routes, which are subject to change.

SERVICE CORRIDORS

Service corridors shall, at all times, be kept clear of materials, equipment, debris and trash. Landlord will charge the General Contractor to clear service corridors of any and all such items. General Contractor agrees to pay such charges to Landlord upon demand.

SITE UTILITIES AND SERVICES

The following is an overview of the utilities and services typically available for in-line retail spaces. Please refer to lease language for any agreed upon changes that may overwrite these typical service provisions. It is the Tenant's responsibility to verify existing conditions and comply with all applicable codes and standards for all Technical systems.

ELECTRICITY

Tenant shell spaces typically provide conduit to a main power source.

DATA AND COMMUNICATIONS

Tenant shell spaces typically provide a conduit with pull string to nearest Granite rack.

Phone and internet services are provided on-site through Granite Grid.

Tenants must coordinate directly with Granite Grid to set up their data utility.

Other data providers do not have a right of access agreement and are not permitted access to the property.

SPRINKLER SYSTEM

Tenant shell spaces typically provide an automatic sprinkler system according to NFPA guidelines.

Tenants are responsible for contracting with the Landlord's required sprinkler vendor to adjust any existing grids, or install new if none exist, and tie into the main system.

LOADING ZONES

Loading Zones will be kept open for deliveries when possible. Parking in Loading Zones is strictly PROHIBITED. Delivery vehicles must be completely unloaded at curb side and then moved out. Unattended parked vehicles in Loading Zones will be tagged or towed at the expense of the Tenant serviced by the vehicle.

FIRE ALARM SYSTEM

Tenants are responsible for contracting with the Landlord's required fire alarm vendor to install all code-required alarm, horns, strobes, conduit within the Tenant's space to tie into the Landlord's main fire alarm panels.

WATER

Tenant shell spaces typically provide domestic cold water stubbed into the space. Size and location of the pipe varies per space. Spaces also typically provide a sanitary line stubbed into the space or located under the floor slab. Size and location of the line varied per space.

Water use is metered and charged by the Landlord for retail Tenants. A separate account with a water utility company is usually not required, unless Tenant is a food use.

HVAC

Tenants are required to furnish and install their own rooftop packaged units to provide HVAC to their space.

GAS

Gas utility is not available for in-line retailers. It is possibly available for food cooking equipment only.

> PRE-CONSTRUCTION / CLOSE OUT

CONSTRUCTION

The following is a brief overview of the construction process and requirements for a tenant build outs:

PRE-CONSTRUCTION

Prior to any construction commencement, the contractor's site superintendent is required to meet with the Landlord to review property construction requirements, submit construction documentation, and provide payment for property construction fees.

Required pre-construction documents include:

- Landlord Approved Construction Drawings
- Contractors Rules & Regulations to be completed and signed in full
- Approved GC Certificate of Insurance
- A copy of the Building Permit issued by the City
- General Contractor's state license
- Construction Progress Schedule
- Subcontractor List (include associated trade, contact name and phone number)

The Landlord will send a Preparedness Letter detailing the fees required for collection prior to scheduling this pre-construction meeting.

CLOSE OUT

At construction completion, the Landlord will meet with the superintendent to perform a punch list walkthrough. The created punch list is required to be completed to the Landlord's satisfaction in order to close out the construction project. All construction charges must be paid in full.

To complete closeout, the following documents are required to be submitted:

- Copy of Certificate of Occupancy or equivalent and Proof of Passing Final Inspections.
- Final list of Subcontractors (please make any changes or additions from the list supplied at pre-con)
- Unconditional Lien Waivers from all contractors, subcontractors and materials and service suppliers.
- Notarized Affidavit from General Contractor stating that no liens exist as a result of Tenant's work.
- Notarized AIA documents G702 & G703 (if the job is \$100,000.00 or more) / General Contractors Final Billing
- AABC or NEBB Certified Air Balance Report
- As-Built Documents (record set of what was constructed at the site, including Architectural, Structural, Mechanical, Plumbing, Electrical, Fire Protection, etc.) Electronic (PDF) format preferred.
- Utilities Form

> PRE OPENING CONDITIONS

PRE-OPENING CONDITIONS

The following conditions are typically required to be addressed during Tenant space construction.

ELECTRIC

Tenant is required to install permanent electric service immediately.
No temporary electric service is available.

WATER

The Tenant will have a water connecton available within the space.

TELEPHONE

Tenant is required to arrange for telephone service directly with telephone carrier. No temporary telephone service is available.

TOILETS

No public restrooms are available during constructon.

TRASH REMOVAL

Tenant will be required to bring trash to a centralized locaton.

Landlord will provide and coordinate dumpsters.

A map will be provided to the Tenant by the Mall Office, as part of the Tysons Corner Center Merchant Handbook, showing the locaton of permanent dumpsters to be utlized upon store opening.

Tenants are required to directly contract with the Mall designated trash removal service.

FOOD TENANT SPECIFIC

A map of the designated grease drop-of barrel locatons will be provided by the Mall Office, as part of the Tysons Corner Center Merchant Handbook. Tenants must contract directly with the following company to arrange for pick-up and billing:

Keter Environmental

Yani Ferreira, Regional Manager

Cell: (317) 935-7075

yferreira@keteres.com

www.keteres.com

**All kitchen plumbing must be connected to a grease interceptor.

> RULES AND REGULATIONS

CONSTRUCTION RULES

Contractors are required to review and sign each page of the Contractor Rules and Regulations document linked in the Addendum. Below is an overview of some of the rules to follow during construction.

WORK AREA

All of contractor's work, storage of materials, construction office, etc., must be confined to within the Demised Premises. Landlord shall have no responsibility or liability whatsoever for any loss or damage to property belonging to Tenant or its contractor, and left in the Demised Premises or anywhere else.

FIRE PROTECTION

Tenant contractor shall provide fire extinguishers within the premises as required by Landlord's Insurance Company and/or Public Safety Officials.

TEMPORARY STOREFRONT CLOSURES

Barricades will be necessary for all construction projects.

Construction barricades will be built by the Mall and graphics for the barricade will be installed by the Mall and both will be paid for by the Tenant's General Contractor upon check-in. Tenant must provide a proof or spec of the graphic artwork in advance for a timely installation.

Barricades can only pop out a maximum of 18" of the Storefront.

Upon completion of construction and with permission from the Mall operations manager, the Landlord will remove the barricade.

Contact: Jim McGrath

ABC Imaging

Phone: (732) 608-3954

jimmcgrath@peeqimaging.com

UNDERSLAB WORK

Zones 3, 4, 5 and 7 - Tenant contractors shall have the right to enter the space below to perform necessary underslab work provided they do not interfere with the work of the Tenant or Tenant Contractor working in said space below and then only at times appointed by Landlord. Such work is to be coordinated by on-site Landlord designated representative.

USE OF MALL

Access to the Mall shall be subject to control at all times by Landlord's Designated Representative.

At no time shall the Mall be used by Tenant Contractor or its employees for lounging, eating, rest breaks, etc.

Smoking or the use of alcohol is strictly prohibited.

Tenant shall be responsible for seeing that this rule is strictly observed by his contractor(s).

ESCALATORS AND ELEVATORS

Designated freight elevators will be available for transporting materials and personnel. At no time shall Tenant Contractor or its employees use escalators for transporting materials, tools, equipment or personnel.

PROTECTION OF WORK AND PROPERTY

Tenant and Tenant Contractor shall protect their work and the work of other Tenants and Landlord from all damage.

STRICTLY PROHIBITED WORK PRACTICES

- Any combustible materials above finished ceilings or in any other concealed non-sprinklered space.
- Imposing any structural load, temporary or permanent, on any part of the Landlord's work or structure without the approval of Landlord's Engineer.
- Cutting any holes in Landlord installed floor slabs, walls or roof, other than those indicated on the Landlord approved Tenant plans, and tampering or removing fireproofing (if applicable) from demised premises.

CORRECTIVE WORK BY LANDLORD

Any fees which shall become due to Landlord by Tenant or its contractor as a result of, and arising out of, Tenant's construction work (including without limitation, electricity charges during construction, trash removal, and damage to Landlord's property) shall be considered as additional rent, and shall become payable immediately upon demand by Landlord.

CONTENT OVERVIEW

7.1

CONSTRUCTION DRAWINGS

SUBMITTAL REQUIREMENTS FOR ARCHITECTURAL AND TECHNICAL DESIGN DOCUMENTS.

7.2

SIGNAGE DRAWINGS

SUBMITTAL REQUIREMENTS FOR PRIMARY AND SECONDARY STOREFRONT SIGN DESIGNS.

7.3

KIOSK DRAWINGS

SUBMITTAL REQUIREMENTS FOR ARCHITECTURAL AND TECHNICAL KIOSK DESIGN DOCUMENTS.

The Submittals Criteria highlights the Landlord review process and drawing submittal requirements to ensure a quick and smooth drawing review for your design and construction drawings.

Tenant construction and signage drawings must be reviewed and Approved by the Landlord before the drawings can be submitted for permit. Permits from the local Municipality are required for all incoming Tenant construction and signage.

It is always the Tenant's responsibility to ensure:

- Compliance with the Lease document.
- Field verification of conditions and dimensions.
- Discrepancies between the drawings and the as-build conditions.
- Coordination with trades to ensure compliance with all local and national codes.

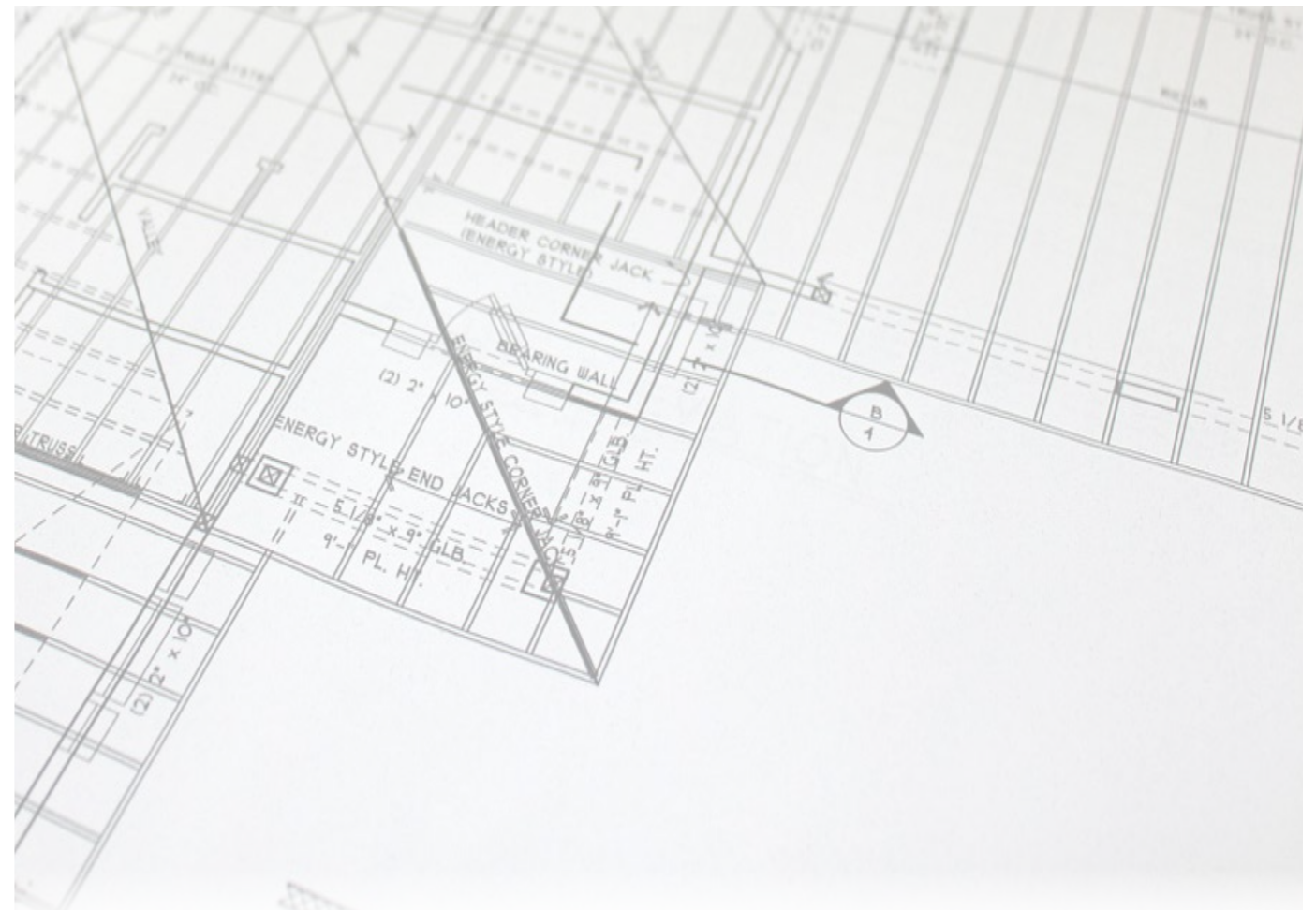

> PROCESS & TIMELINE

DRAWING REVIEW PROCESS

Drawing reviews are required to be submitted in two stages for Landlord review; Preliminary and final Construction Drawings. Preliminary drawings are required to ensure the design process moves quickly by ensuring that all Criteria requirements are understood and adopted early in the design. This helps ensure an expedited review of the final Construction Drawings.

REVIEW TIMELINE

Step	Action	Time Period
1	Tenant submits preliminary design.	Required 20 days after Lease Execution or 10 days following previous submittal disapproval.
2	Landlord Approved Preliminary Design.	15 days after confirmed completion of Step #1.
3	Tenant submits final construction drawings.	Required 20 days after Tenant Coordinator approval at Step #2.
4	Landlord Approves final documents.	15 days after completion of Step #3.
5	Tenant submits drawings for permit. (If applicable)	5 days after confirmed completion of Step #4.
6	Tenant responds to any requests from or comments by permitting jurisdiction.	5 days.
7	Upon permit review approval, Tenant pays all fees and logs out permit.	5 days.

> SUBMITTAL REQUIREMENTS > PRELIMINARY

PRELIMINARY DESIGN SUBMITTAL

The Preliminary Document review process will evaluate all the criteria discussed in this manual, including overall three-dimensional form, degree of design uniqueness and identity, use and detailing of materials, colors and lighting, and integration of signage and graphics.

Submittals are to provide the reviewer with a clear understanding of proposed design concepts.

The submission must be complete in order to fairly evaluate the proposal and prevent continuation of work on an unacceptable design.

Tenant shall submit to Landlord electronic PDF files of the following:

- **Color and Material Sample Board**
Include actual samples of all Tenant colors and materials visible to the public, on a digital sample board. Clearly label all materials and reference to floor plan elevations.
- **Perspective and/or Photo Image(s)**
Colored perspective rendering and/or prototypical photo images of the proposed storefront, including graphics and signage.
- **Cover Sheet**
Include: Name of Tenant, name of Mall or Center, space number, Applicable Codes, Building Type and Occupancy Type, Leased square footage, and Key Plan
- **Floor Plan**
¼" Scale Minimum showing: Entire lease dimensioned space with room names, floor finishes, casework and fixture locations.
- **Reflected Ceiling Plan**
¼" Scale Minimum showing: Lighting design, including fixture types and locations, signage, access panels, Overhead projections such as light coves and fascia systems, and Entrance.
- **Sections**
1" Scale Minimum showing: Entry, Display windows and fascia, Sign integration into storefront design.
- **Storefront Elevations**
½ Scale Minimum showing: Exterior views - front and sides, Signs, graphics, logos.

A physical sample board is also required, mounted on foam core or card stock to be sent in coordination with your Tenant Coordinator.

> SUBMITTAL REQUIREMENTS > FINAL

FINAL DRAWING SUBMITTAL

After Preliminary Drawing Approval, it is critical to quickly complete and submit Final Construction Drawings for Landlord review.

If any questions arise from the Tenant's interpretation of the design and criteria information, the Tenant shall assume all responsibility for clarification by written request to the Tenant Coordinator. The Landlord plan review and approval process is independent of local permitting for construction. The Tenant is responsible for procurement and compliance with local, state and federal codes and requirements.

Tenant shall submit to Landlord electronic PDF files of the following:

- **Responsibility Schedule**
Any work, which is the Landlord's responsibility, must be listed clearly on a responsibility schedule on the cover sheet.
- **Cover sheet**
Include a Key Plan, Name of Tenant, name of Mall or Center, space number and location leased premises within Mall or Center, Applicable codes, building type and occupancy type, Leased square footage, Responsibility schedule, and Drawing index.
- **Floor Plans**
¼" Scale Minimum showing: Entire lease space with room names, Floor finishes, casework and fixture locations, and Demolition plan.
- **Reflected Ceiling Plan**
¼" Scale Minimum showing: Complete lighting design, including fixture types and locations, signage, access panels, Overhead projections such as light coves and fascia system, Entry, Connection to Landlord's work, Tenant's framing and/or additional structure showing freestanding from Landlord's structure.
- **Sections**
1" Scale Minimum showing: Entry, Display windows and fascia, Sign integration into storefront design, Connection to Landlord's work, Tenant's framing and/or additional structure showing freestanding from Landlord's structure.
- **Interior Elevations**
¼" Scale Minimum showing: All sales floor interior views, Built-in casework, signage, and display systems.
- **Storefront Elevations**
½" Scale Minimum showing: Exterior views - front and sides, Signs, graphics, logos, Landlord neutral piers, Storefront finishes (to be referenced to finish schedule)
- **Architectural Details**
½" Scale Minimum.
- **Door Schedule**
Include floor transition details and anti-theft security system details.
- **Details, Catalogue Cut Sheets, and Fixture Finishes**
- **Finish & Color Schedule**

> SUBMITTAL REQUIREMENTS > FINAL ENGINEERING

FINAL DRAWING SUBMITTAL - ENGINEERING DRAWINGS

The Landlord does not review for mechanical, electrical, plumbing, or structural design, nor does the Landlord accept responsibility for the Tenant's adherence to governing codes.

Tenant shall submit to Landlord electronic PDF files of the following engineering drawings included in the final drawing set:

I. MECHANICAL DESIGN DOCUMENTS

- Make, type, and performance of all equipment.
- Sign and seal by a Licensed Engineer in the state where the Shopping Center is located.
- Calculations showing the heating and cooling required, including transmission and ventilation losses in the space, and heat and cooling provided for the ventilation supply, and exhaust required for the space. Calculations must be performed in accordance with the latest ASHRAE standards and tabulated in a concise, orderly manner.
- Temperature control system data showing make, control, and energy management systems.
- Exhaust system layout including CFM and equipment specifications.
- Reflected ceiling plan showing HVAC equipment.
- Roof plan with equipment locations.
- Structural details for support of all rooftop equipment and equipment suspended from the steel structure.

II. PLUMBING DESIGN DOCUMENTS

- Make, type, and performance of all equipment.
- Sign and seal by a Licensed Engineer in the state where the Shopping Center is located.
- Complete plumbing system design and floor plan for the Tenant space including, but not limited to the toilets, sinks, urinals, drains, hot water heaters, water coolers, grease trap/interceptors and connections into existing water and sewer lines.
- Single line diagram.
- Fixture schedule.
- Water heater detail as applicable.
- Grease trap cut sheets as applicable.

**All kitchen plumbing must be connected to a grease interceptor.

III. FIRE PROTECTION / SMOKE EVACUATION DESIGN DOCUMENTS

- Reflected ceiling plan, with revised sprinkler head locations.
- Design must be City approved before construction

IV. ELECTRIC DESIGN DOCUMENTS

- Sign and seal by a Licensed Engineer in the state where the Shopping Center is located.
- Panel schedules, load calculations, and meter information, if applicable.
- Structural drawings for all equipment that will be suspended from the steel structure.
- Electrical load summary and Title 24 Energy Calculations (for State of California).
- Floor plan depicting equipment locations and branch circuitry.
- Reflected ceiling plan depicting the layout of light fixtures.
- System one line diagrams.
- Lighting fixture schedule.
- Equipment legend.

V. STRUCTURAL DESIGN DOCUMENTS

- Design elements affecting the structure of the base building.
- Alterations, additions, modifications and reinforcements to the base building which shall be required to accommodate Tenant's Work.
- All calculations & details (Include ICBO numbers on all framing details, Seismic bracing details for State of California.)
- All forms required by governmental agencies and Governmental Regulations, fully and properly completed and executed by Tenant.
- Partial structural framing plan showing existing conditions for new and existing rooftop installations and proposed reinforcement, which shall be accompanied by structural engineers' calculations, drawn on a scale of $\frac{1}{2}''=1'0''$.
- Ceiling, soffits, storefront attachment details to existing base building.
- A letter from a state-registered structural engineer certifying that all new equipment and design elements serving the Premises are adequately supported to carry the new load.

> PROCESS & TIMELINE

DRAWING REVIEW PROCESS

Sign drawing reviews are required to be submitted in two stages for Landlord review; Preliminary and final Construction Drawings. Preliminary drawings are required to ensure the design process moves quickly by ensuring that all Criteria requirements are understood and adopted early in the design. This helps ensure an expedited review of the final Construction Drawings.

REVIEW TIMELINE

Step	Action	Time Period
1	Tenant submits preliminary design.	Required 20 days after Lease Execution or 10 days following previous submittal disapproval.
2	Landlord Approved Preliminary Design.	15 days after confirmed completion of Step #1.
3	Tenant submits final sign drawings.	Required 20 days after Tenant Coordinator approval at Step #2.
4	Landlord Approves final documents.	15 days after completion of Step #3.
5	Tenant submits drawings for permit. (If applicable)	5 days after confirmed completion of Step #4.

> SUBMITTAL REQUIREMENTS > PRELIMINARY, FINAL

PRELIMINARY DESIGN SUBMITTAL

The Preliminary Document review is intended to acquaint the Landlord with the Tenant's signage design intent.

Submittals are to provide the reviewer with a clear understanding of proposed design concepts.

The submission must be complete in order to fairly evaluate the proposal and prevent continuation of work on an unacceptable design.

Tenant's licensed sign contractor shall submit to the Center's Tenant Coordinator electronic PDF files of the following:

- **Perspective and/or Photo Image(s)**
Colored perspective rendering and/or prototypical photo images of the proposed storefront, including graphics and signage.
- **Storefront Elevations**
½ Scale Minimum showing: Exterior views - front and sides, Signs, graphics, and logos highlighting sign dimensions and materials.

FINAL DRAWING SUBMITTAL

After Preliminary Drawing Approval, it is critical to quickly complete and submit Final Construction Drawings for Landlord review.

If any questions arise from the Tenant's interpretation of the design and criteria information, the Tenant shall assume all responsibility for clarification by written request to the Tenant Coordinator. The Landlord plan review and approval process is independent of local permitting for construction. The Tenant is responsible for procurement and compliance with local, state and federal codes and requirements.

The Landlord does not accept responsibility for the Tenant's adherence to governing codes or verification of job site conditions.

Tenant's licensed sign contractor shall submit to the Center's Tenant Coordinator electronic PDF files of the following:

- Elevation of the storefront including signage and graphics; showing all doors, architectural features, etc., and fully detailed/dimensioned sections and details through the storefront.
- These fully detailed and dimensioned drawings shall be drawn to scale as noted:
 - Storefront Plan, Elevation and Sectional views at 1/2 inch scale.
 - Details of the Signage at 1/2 inch scale or larger.
 - Storefront Signage at 1/2 inch scale.
- Letter style and typeface specifics.
- Color and finish qualities of all portions of signage.
- Material specifications and thickness.
- Transformer specifications, including input and output voltage of transformers. PK housing, (or other UL approved insulating sleeve approved by Landlord and local building codes), is required for all through wall penetrations and must be indicated on the sign shop drawings. Wiring specifications.
- Locations of service switches, access panels and transformers. NONE of these items shall be visible to the public from any portion of the Mall.
- Neon tube specifications, including color and dimension (in mm) of tubes to be used.
- Type of lamps.
- Mounting hardware.

> PROCESS & TIMELINE

DRAWING REVIEW PROCESS

Kiosk drawing reviews are required to be submitted in two stages for Landlord review; Preliminary and final Construction Drawings. Preliminary drawings are required to ensure the design process moves quickly by ensuring that all Criteria requirements are understood and adopted early in the design. This helps ensure an expedited review of the final Construction Drawings.

REVIEW TIMELINE

Step	Action	Time Period
1	Tenant submits preliminary design.	Required 20 days after Lease Execution or 10 days following previous submittal disapproval.
2	Landlord Approved Preliminary Design.	15 days after confirmed completion of Step #1.
3	Tenant submits final construction drawings.	Required 20 days after Tenant Coordinator approval at Step #2.
4	Landlord Approves final documents.	15 days after completion of Step #3.
5	Tenant submits drawings for permit.	5 days after confirmed completion of Step #4.

> SUBMITTAL REQUIREMENTS > PRELIMINARY, FINAL

PRELIMINARY DESIGN SUBMITTAL

The Preliminary Document review is intended to acquaint the Landlord with the Tenant's signage design intent.

Submittals are to provide the reviewer with a clear understanding of proposed design concepts.

The submission must be complete in order to fairly evaluate the proposal and prevent continuation of work on an unacceptable design.

Tenant's licensed architect shall submit to Landlord electronic PDF files sized 24" x 36" format of the following on:

- Colored perspective rendering and/or prototypical photo images of the proposed kiosk, including graphics and signage.
- A material sample board, (8-1/2" x 11" minimum), clearly noting the Tenant name and Mall name.
- A floor plan.
- Sections and elevations of the kiosk.

FINAL DRAWING SUBMITTAL

After Preliminary Drawing Approval, it is critical to quickly complete and submit Final Construction Drawings for Landlord review.

If any questions arise from the Tenant's interpretation of the design and criteria information, the Tenant shall assume all responsibility for clarification by written request to the Tenant Coordinator. The Landlord plan review and approval process is independent of local permitting for construction. The Tenant is responsible for procurement and compliance with local, state and federal codes and requirements.

The Landlord does not accept responsibility for the Tenant's adherence to governing codes or verification of job site conditions.

Tenant's licensed architect shall submit to Landlord electronic PDF files sized 24" x 36" format of the following on:

- A cover sheet including a vicinity map, location map, (LOD), all code compliance notes as required by the city.
- Floor plan detailed and scaled, showing all components, counters, cash wraps, islands, condiment area layout, partitions etc.
- All finishes and fixtures with complete schedules and keyed plans and elevations.
- Details and sections of each side as well as the pylon, counter edge, millwork, toe kick, raised flooring, wall caps, special conditions etc.
- All interior and exterior elevations, with sign locations and dimensions.
- Anything necessary to describe structures or design features, not depicted or easily understood.
- Electrical drawings including a plan layout.
- Plumbing drawings, if applicable.
- Equipment schedule and finish schedule.
- Sign shop drawings, with plan, elevations, sections, materials and details.

ADDENDUM LINKS

This Addendum contains links to supplemental documents of specific requirements and information. These documents are considered part of the Tenant Criteria Package. Clicking the links below will navigate to the described documents. It is the responsibility of the Tenant, its contractors, subcontractors, architects, engineers, employees, and agents to comply with terms of the Tenant Criteria, Addendum included.

GLOSSARY

I. [GLOSSARY](#)

Defines commonly used terms for clarity.

DESIGN ADDENDUM

I. [MACERICH SUSTAINABILITY HANDBOOK](#)

Guide to encourage energy efficient, sustainable design.

BARRICADE ADDENDUM

I. [BARRICADE GUIDELINES](#)

Guide to installing and activating construction barricades with graphics.

CONSTRUCTION ADDENDUM

I. [TYSONS CONTRACTOR RULES AND REGULATIONS](#)

Document detailing the rules and regulations Tenant contractors must adhere to during their construction. This document must be reviewed and signed by the Site Superintendent overseeing the Tenant build out.

II. [TYSONS SAMPLE CERTIFICATE OF INSURANCE](#)

Sample Certificate of Insurance form detailing the levels of insurance coverage Macerich requires to perform work in the Center.

III. [HOT WORK PERMIT](#)

Required form to submit when construction required hot work.

IV. [PUNCH LIST](#)

Reference Landlord Punchlist that that Landlord will use to inspect and confirm completion of Tenant construction.

BASE BUILDING DESIGN AND CONSTRUCTION EXHIBITS

I. [WATER METER SPECIFICATIONS AND EXHIBIT A, B, C](#)

Spec sheet for the required water meter at the Center, Exhibit A AHU Commissioning Start-up Checklist, Exhibit B Belimo Single Line Diagram, Exhibit C Belimo Energy Valve

II. [EXHIBIT 1A. STRUCTURAL CERTIFICATION FOR ZONES 1 AND 3](#)

Document certifying the building structure for Zones 1 and 3.

III. [EXHIBIT 1B. STRUCTURAL CERTIFICATION FOR ZONES 2 AND 4](#)

Document certifying the building structure for Zones 2 and 4.

IV. [EXHIBIT 2. FIRE ALARM SYSTEM INTERFACE](#)

Spec sheet for the Center's Fire Alarm System Interface.

V. [EXHIBIT 3. FOOD TENANT EXHAUST AND GREASE SPECS FOR ZONES 2 AND 5](#)

Specifications for interfacing grease and exhaust systems for food Tenants in Zones 2 and 5.

VI. [EXHIBIT 4. ELECTRICAL SPECS ZONES 1 THRU 5](#)

Low voltage device spec sheets for Tenants in Zones 1 thru 5.

VII. [EXHIBIT 5. TYPICAL ROOF PENETRATION DETAILS](#)

Detail drawing of a typical roof penetration.

VIII. [EXHIBIT 6. TYPICAL SLAB ON GRADE DETAIL](#)

Detail drawing of a typical slab on grade.

IX. [EXHIBIT 7. FLOOR PENETRATION DETAIL](#)

Detail on how to penetrate the slab.

X. [EXHIBIT 8. TYPICAL JOIST REINFORCEMENT DETAIL](#)

Detail on how to properly reinforce building joists.