



S·C·O·T·T·S·D·A·L·E

Fashion Square

TENANT CRITERIA

MACERICH®

VISION STATEMENT

Welcome to Scottsdale Fashion Square.

It is our vision and mission at Macerich to distinguish ourselves through superior performance in retail development and continuous improvement of our portfolio, to meet the changing needs of our customers and the retailers we serve. Our commitment is to furnish a well-designed, well-maintained and well-marketed retail environment, capable of maximizing traffic and sales.

We are pleased to become partners with retailers, striving for the same goals. We are ready to facilitate communication and share our expertise with you to complete your store within expected timelines.

These criteria act as a guide for the design of all work by Tenants in conjunction with the provisions of the Tenant's lease with the Landlord. Tenants are encouraged to express their own unique design statement within the parameters of the Design Criteria as outlined in this manual.

National and regional "standard" storefront concepts are respected to the extent that they meet the Design Criteria. However, Tenants should be aware that some concept modifications might be necessary to comply with the Center's Criteria.

The same is true for proposed designs that are overly similar to a neighboring Tenant's Storefront design. We wish to make the Mall as diverse and interesting as possible and enable each Tenant to make a singular statement with their design.



CRITERIA MAIN CONTENTS

1.0 **INLINE**
CRITERIA FOR ARCHITECTURAL, SIGNAGE, AND TECHNICAL DESIGN FOR INLINE RETAIL LOCATIONS.

2.0 **FOOD**
CRITERIA FOR ARCHITECTURAL, SIGNAGE, AND TECHNICAL DESIGN FOR INLINE FOOD, FOOD COURT/HALL, AND RESTAURANTS.

3.0 **BUILDING DETAILS**
ARCHITECTURAL DETAILS, REQUIREMENTS AND REFERENCE PLANS BASED ON STORE LOCATION.

4.0 **DESIGN INSPIRATION**
SUGGESTED DESIGN MOTIFS AND INTRO TO KEY DESIGN ELEMENTS.

5.0 **PROPERTY INFO**
PROPERTY LOCATION, CONTACTS, UTILITIES OVERVIEW, OPERATIONS, AND LOCAL PERMITTING INFO.

6.0 **SUBMITTALS**
REQUIREMENTS TO SUBMIT CONSTRUCTION DRAWINGS, RENDERS, SIGN DRAWINGS, AND MATERIAL BOARDS.

7.0 **ADDENDUM**
SUPPLEMENTAL DESIGN AND CONSTRUCTION REQUIREMENTS AND DETAILS PROVIDED AS LINKS TO EXTERNAL DOCUMENTS.

i **INTERACTIVE NAVIGATION**

This Criteria is an interactive document. You may tap or click the top Navigation Bar or the Side Content Bar to navigate directly to that section.

This page serves as a hub to the various sections included in this Criteria.

The sections in this Criteria break down the key categories of information to understand the design and construction requirements to incorporate a successful retail experience. Refer to the overviews included in the left side bar to learn more about the content included in each section.

It is the responsibility of the Tenant, its contractors, subcontractors, architects, engineers, employees, and agents to comply with terms of the Tenant Criteria, including the supplemental documents included in the Addendum.

The intent of this Criteria manual is to:

- Accelerate the leasing process by providing quick answers to questions about specific requirements.
- Establish the design expectations and technical requirements.
- Establish a coherent design by carefully curating and integrating within the Center.
- Guide the design standards.
- Answer basic questions about the design and construction process.
- Save time by minimizing design reviews.



INLINE RETAIL CONTENT OVERVIEW

1.1

DESIGN

CRITERIA FOR ARCHITECTURAL DESIGN REQUIREMENTS FOR RETAIL STOREFRONTS AND INTERIORS.

1.2

SIGNAGE

CRITERIA FOR PRIMARY AND SECONDARY STOREFRONT AND WINDOW SIGN DESIGNS.

1.3

TECHNICAL

CRITERIA FOR TECHNICAL DESIGN ELEMENTS TO ENSURE YOUR STORE CAN INTERFACE WITH THE PROPERTY'S BASE BUILDING UTILITY SYSTEMS.

SECTIONS OF INTEREST

BUILDING DETAILS

Includes property reference photos and specific Storefront design details.

PROPERTY INFO

Includes information on the Property's building codes, area permitting, and required contractors.

SUBMITTALS

Outlines requirements on how and what to compile for submittals to the Landlord for design reviews.

DESIGN INSPIRATION

Provides visual inspirations for design aesthetics.

The Inline Retail Criteria provides key technical information and design requirements to ensure your store enlivens the consumer experience and interfaces with the Center.

The Tenant and the Tenant's Architect assume the following important obligations:

- Fulfill the intent of the Criteria both in concept and in detail.
- Determine and respond to the actual physical conditions of the Tenant's location.
- Maintain and enhance the high standards of quality established in the construction of the Center.
- Ensure the quality of execution of all design material, finish, and detail concepts in the construction of the Tenant's improvement.
- Provide the required detail at all transitions from Tenant Storefront to neighboring Storefronts, as well as to the base building.



DESIGN CRITERIA

☐ STOREFRONTS

- ☐ ENTRY
- ☐ POP-OUTS / STOREFRONT HEIGHTS / NEUTRAL PIER / CONSTRUCTION

☐ DESIGN CONTROL AREA

- ☐ DESIGN REQUIREMENTS / WINDOW DISPLAY / PROHIBITED DESIGN ELEMENTS

☐ MATERIALS

- ☐ GLAZING / DECORATIVE GLASS
- ☐ WOOD / STONE / PLASTER
- ☐ METAL / LEATHER
- ☐ WALLCOVERINGS / SOLID SURFACE
- ☐ PAINT / FAUX FINISHES / FABRIC / TILE

☐ INTERIORS

- ☐ LIGHTING / FLOORING
- ☐ CEILING / WALLS & PARTITIONS
- ☐ EGRESS DOORS / RESTROOM

SECTIONS OF INTEREST

- ☐ BUILDING DETAILS
Includes property reference photos and specific Storefront design details.
- ☐ PROPERTY INFO
Includes information on the Property's building codes, area permitting, and required contractors.
- ☐ SUBMITTALS
Outlines requirements on how and what to compile for submittals to the Landlord for design reviews.
- ☐ DESIGN INSPIRATION
Provides visual inspirations for design aesthetics.

Tenants are encouraged to express the individuality of their brand through excellent design by forward thinking design teams.

This Design Criteria focuses on strong design details visible from the Center common areas. Focusing on a strong Storefront design enlivens the retail experience and draws customers in to shop. Macerich's Design team is always excited to partner with Retailers in curating a unique and memorable shopping experience. Our team is available to collaborate on your enticing Storefront designs. The [DESIGN INSPIRATION](#) section is also a great launching point to explore design concepts and methods to engage customers.

- All Tenants must engage a reputable Architect.
- Design drawings must all be reviewed and Approved by the Landlord.
- All design elements and finishes must adhere to local and national building code requirements.



> STOREFRONTS

The Center's success is dependent on the creative design contributed by individual Tenants. It is vital that your Storefront design is integrated with the look and feel of the Center's aesthetic.

The [BUILDING DETAILS](#) section includes specific storefront design requirements based on your store's location. These location based requirements must be incorporated into your Storefront's final design.



> ENTRY

ENTRY

Your Storefront entry is a critical design feature to create an invitation to shop. As such all stores must express the entry as an identifiable part of the storefront. The underside of the entry portal soffit shall be finished to match the storefront.

I. SWING DOOR ENTRY

- Swing doors should be located in a recessed vestibule a minimum of 3' from the Storefront.
- No door swing shall project beyond the maximum allowable lease line.
- Minimum allowable door height is 9'-0". Door opening fasteners must be provided in the floor or tenant storefront.
- All other doors are to be hinged or pivot-type doors. Doors are suggested to be the height of the glazed Storefront.
- Recessed entry flooring shall be Tenant's flooring finish out to the lease line.

II. OPEN STOREFRONT ENTRY

- An open Storefront must also present an entry zone. Macerich will review all open Storefronts for alternate articulation and dimensional elements.
- Tenants choosing to have an open storefront are required to secure the premises after business hours with a coiling, sliding or folding security closure which complies with the following design guidelines:
 - Shall coil overhead or coil, fold or slide horizontally to retract into pockets or enclosures to conceal from view during business hours.
 - All supports, tracks, guides and operating devices must be concealed flush with adjacent Storefront finishes when closure is in the open position and be integrated into the Storefront overall design expression.
 - Horizontal tracks are not allowed in the floor surface.
 - Exposed locking devices or latches are not allowed. Key switches shall be concealed and mounted within the Tenant Storefront proper.
 - All supports to be provided by Tenant. Suspending closures from existing building structure is not allowed.



> POP-OUTS / HEIGHTS / NEUTRAL PIER / CONSTRUCTION

POP-OUTS

Three dimensional pop outs in both plan and height are required for all Storefronts in all new Tenant areas.

- When storefronts are visible from the upper level, special care must be taken so the top is finished to match the Storefront design.
- Exposed conduits, raceways, access panels or equipment may NOT be visible.
- All surfaces of any visible projections must also be finished to match.
- No dust or falling debris may collect on surfaces visible from upper levels. Tenant is responsible for the upkeep of all surfaces.
- Designs may incorporate sloping tops at no less than a 3 in 12 pitch to create a debris resistant surface.

STOREFRONT HEIGHTS

All Storefronts must extend up to a maximum heights per the specific location of your store. Please refer to the [ZONE PLAN](#).

NEUTRAL PIER

Tenant Storefronts are to abutt each other, separated by a reveal. Tenant under construction is responsible for the installation of the reveal between adjacent storefronts, if not currently existing.

STOREFRONT CONSTRUCTION

- All storefront construction shall be self-supported from the floor and independent of the building fascia and bulkhead structure.
- Storefronts may be braced to the overhead structure within the Tenant space.
- Connections to the deck, mall mechanical, electrical, plumbing, or fire protection equipment for support is not permitted. This includes ceiling splay wires.
- Storefront to be built on bare concrete floor and not on Landlord tile.
- Tenants will provide a flush transition between their flooring and the Mall flooring
- Pedestal type security system not allowed. Tenant can specify concealed system. Tenant to submit specifications to Landlord for approval.
- Storefronts must incorporate a minimum 4x4x4 recessed drywall reveal. Back side of reveal must be painted drywall in a color that compliments but does not match adjacent finish.
- Blade signs are not allowed.



> DESIGN CONTROL AREA

The Design Control Area (DCA) is the zone extended from the storefront lease line to 10'-0" inside your space, including all display windows and retail graphics, display fixtures, signs, materials, finishes, color and lighting fixtures within the area.

At Macerich, we take special interest in the DCA as an extension of the retail presentation and showcase of the store's merchandising. The intent is to convey excitement, and give the consumer a reason to shop.

Use of a professional Visual Merchandisers is highly encouraged. Design drawings shall have a display layout plan. The layout plan shall have cut sheets for fixture and/or mannequin types and include photographs of any existing Storefronts a Tenant may have that will enhance the layout plan. A rendering is required if photographs are not available.

Stores with both interior and exterior presence must activate both DCA areas. Tenants are encouraged to maintain open visibility into their Store to draw in Customers.



> REQUIREMENTS / WINDOW DISPLAYS / PROHIBITED ELEMENTS

DESIGN REQUIREMENTS

- A drywall ceiling is required the entire 10' depth of the design control area.
- Ceiling must be a hard surface.
- Lighting fixtures must be consistent with the character of the Storefront design.
- Recess all lighting fixtures.
- A minimal profile track lighting system matching the color of the ceiling plane is allowed.

WINDOW DISPLAYS

Displays should be deliberate and integrated flush into the Storefront. Modulation of display systems and built-in architectural components will reinforce the design.

- Display cases must be adequately lit and ventilated.
- Digital monitors are permitted as part of the storefront design on a case by case basis, if integrated into the design and approved by Landlord. Coordinate with Tenant Coordinator for exterior applications and to confirm code or local requirements.

PROHIBITED DESIGN ELEMENTS

- Track lighting is not permitted in the DCA.
- Temporary signs for sales or clearances shall not be hung in the DCA or affixed to the glass inside or outside.
- No pegboard, slat wall or metal shelving of any kind may be placed in or extend into any part of the DCA.
- Security devices or freestanding pedestals are not permitted. They must be integrated and concealed.
- Exposure of incandescent bulbs and/or fluorescent tubes are not allowed.



> MATERIALS

As an important aspect of presenting the Tenant's unique brand image, finish materials are to be composed, articulated and executed in a creative and quality manner.

All materials and applied finishes on the Storefront are to be high-grade, durable, non-corrosive and code compliant. They are to be maintained by Tenant at the Tenant's expense. All materials and finishes are subject to Landlord approval, and the inclusion of natural materials is encouraged.

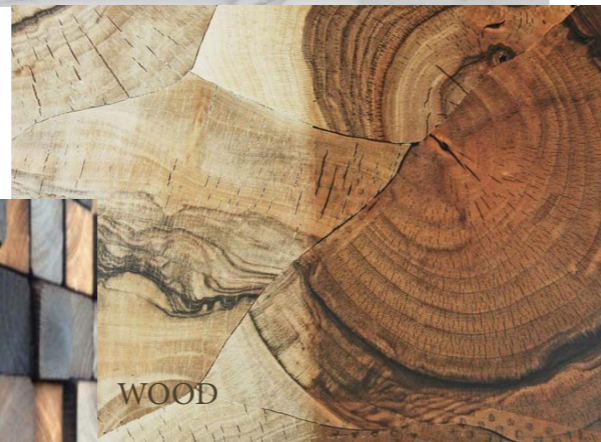

> GLAZING / DECORATIVE GLASS

GLAZING

Storefront glazing, particularly clear glazing, is a key component to establish design character and create an invitation for the customer to visit.

- A minimum of 60% of the Storefront is to be display windows with clear glass.
- Reflective glass (including extensive use of mirror) and/or tinted glass is not permitted on Storefronts or in the Storefront entry zone.
- Tinting or films applied after the glass is installed is prohibited, unless approved as part of the design drawings.
- All glass shall be tempered. Glazing must be a minimum of ½" thick, and large panes of glazing must be of sufficient thickness to meet code and be properly supported.
- Tenants may be required to provide seismic clips to stabilize tall expanses of glass. Silicone sealant at glazing joints is not permitted.
- Butt-joint glazing is encouraged for show windows that in-fill larger Storefront forms. Glass shall be clear polished plate or tempered glass as required by code.
- Window mullions are required to meet all material and finish standards.
- Decorative glazing such as colored, beveled, sandblasted or etched glass may be used to create accent pattern and interest. Decorative glazing can be used as an accent, but must meet all material standards.
- 6" white vinyl suite numbers must be placed in the bottom left of the Tenant storefront glass.

DECORATIVE GLASS

Decorative glass may be considered to provide a unique feature to the storefront.

- In frame-less assemblies, glass panel joint details edges must be polished, ground or chamfered. Glazing channels at corner conditions must be mitered.
- All exterior glazing units must have a solar heat gain coefficient (SHGC) of not more than 0.27 and a U-value of not more than 0.28.
- Exterior glass must be a minimum of 1" insulated, low E units. 0.27 and a U-value of not more than 0.28.



> STONE / PLASTER / DECORATIVE GLASS

WOOD

Wood material can be used for Storefront construction but must comply with all local and national code requirements.

- Applications of painted or stained wood may include window frames, decorative trim, molding and solid areas, such as decorative bulkheads. In some cases, it may be used for larger architectural elements, such as columns and entablatures.
- Wood paneling and plank construction are not acceptable unless presented in a highly imaginative concept and approved by the Landlord.
- Wood specified for interior Storefronts must be kiln dried, mill quality hardwood and must meet local flame spread requirements (Class III 76-200), as well as comply with all code requirements.
- Painted wood must have a shop quality enamel finish. Wood without a paint finish must receive a clear, preservative sealant.
- A mock-up of the materials, colors, textures, or application may be required at Landlord's discretion.
- Storefront base material may not be wood



STONE

Granite, marble, limestone, travertine, slate, adoquin and other natural stone materials may be used for Storefront applications.

Stone may be polished, unpolished, sandblasted, flamed, honed, split-face or carved.

- Natural stone must be protected against staining and discoloration by means of sealers appropriate to the material.
- Craftsman-like attention to detail is required at all connections and transitions to other materials, and we recommend utilizing metal reveals for a clean finish.
- Corner and edge details must prevent visible unfinished edges. Exposed edges must be quirk mitered, chamfered or polished to match adjacent surface finish.

PLASTER

Cement plaster (stucco) and Venetian plaster finishes may be considered for limited storefront applications.

- Apply an even texture of light dash, sand or smooth finish.
- Plaster or stucco should not be the primary Storefront material. Finishes should be used in combination with other high quality materials.



> METAL / LEATHER

METAL

Metal panel may be used to provide alternate texture on a portion of the storefront.

- High quality is expected for all metal applications, including careful finishing and quality fastener detailing.
- Metals may include: shop-painted aluminum and steel, stainless steel, solid brass, bronze, pewter, or enamel coated steel, and may be used for hardware, trim and panels when well designed and detailed.
- The following notes on metal material details must be called out on the submitted drawing set:
 - Minimum 1/2" thick fire-rated plywood or other solid substrate is required behind all metal panels.
 - Minimum 18 gauge metal panels are required.
 - All seams between metal panels must be identified on the storefront elevation and must be properly addressed during design review process.
- The following metal surface treatments are not allowed:
 - Oil canning (resulting from light reflection on an uneven or buckled surface)
 - Scratches
 - Warps, dents, occlusions
 - Visible seams or other imperfections
- Reveals, turn-in seams, welding or similar must be specified and detailed for approval. Metal panels will not be allowed to directly come into contact with adjacent panel or other materials.
- No visible fasteners are permitted.
- Lap joints and seams must be even, straight, and concealed when possible. Outside corners are to be mitered or continuous break shaped.
- Sealants on natural metals are required to prevent tarnishing and must be maintained by Tenant at Tenant's expense.



LEATHER

The use of leather "tiles" for vertical application can add a level of depth and texture to the Storefront. However, these tiles should not be used at an elevation that can be reached by the general population due to the delicate finish and to prevent damage over time.

- The Landlord recommends keeping the use of leather tiles on the Storefront above 7'-0" AFF.

> WALLCOVERINGS / SOLID SURFACES

WALLCOVERINGS

Wallcoverings can add depth and texture to Tenant Storefronts, but need to be applied accordingly based on the durability of the product.

Vinyl, Paper, or Fabric Wallcoverings are not considered durable and are expressly prohibited in the use of Tenant Storefronts.

- Any wallcoverings located at pedestrian level (below 7'-0" AFF) must be extremely durable and rated by the manufacturer for high traffic use.
- Any wallcoverings located above pedestrian level (higher than 7'-0" AFF) must be durable and washable for maintenance purposes.
- Removable/repositionable wall coverings are not permitted for Storefront use.
- All wallcovering applications must appear seamless and be securely affixed with commercial grade adhesive rated for high traffic use covering the entire back of the product.
- All maintenance of wallcoverings is by Tenant. No peeling, bubbling, or other separation of the wallcovering from the applied substrate is permitted to remain, and is the responsibility of the Tenant to repair in a time frame deemed acceptable by the Landlord.



SOLID SURFACE

The use of large format solid surface panels can effectively mimic luxury materials in places where cost may be an issue (IE: Caesar Stone or Cambria), or to provide even, diffuse lighting elements in the storefront (IE: Lumicor or 3Form).

- All solid surface products must be rated for heavy duty commercial applications – residential quality products are not permitted.
- Joints, flat seams, and corner conditions of solid surface materials must be tight and seamless.
- All visible edges must be finished to the same level and quality as the front face of the material.
- If the body of the product is not consistent throughout, a mitered corner detail is required to keep the presentation clean.
- All corners and edges must be eased for safety purposes.
- No adhesive can be visible in the final application.



> PAINT / FAUX FINISHES / FABRICS / TILE

PAINT

- Surfaces should be maintained as an even and durable surface finish, at all times.
- Any paint application should show uniformity without evidence of touch-ups or batch variation.
- Paint should be colorfast, and well executed to prevent lap marks, brush marks, or poor coverage.
- Surfaces and materials shall be prepared and staged correctly to avoid problem conditions such as poor adhesion, sagging, chipping or flashing.
- Painted metal surfaces are not allowed.
- Painted gypsum board is not permitted on the storefront unless there is a factory applied finish of baked enamel or powder coat treatment.
- Painted MDF may be used with a finish process of 1 coat primer, 2 coats finish (sprayed and sanded between each step). Minimum thickness of the MDF is 3/4" on Storefronts.

FAUX FINISHES

Faux finishes may be used at the Landlord's discretion.

- Actual samples of the faux finish must be submitted to the Landlord. Photographs of previous examples are helpful but may not be substituted for an actual sample.
- Faux finishes must be executed by a commercial artisan specializing in that medium.

FABRICS

- Fabrics shall be commercial grade and tested in accordance with ACT Guidelines.
- Specifics for flammability and four aspects of fabric durability: Wet & Dry Crocking, Colorfastness to Light, Physical Properties, and Abrasion are to be documented for each fabric specified and available for Landlord review if requested.

TILE

- Tile may be used in diverse applications and is encouraged to introduce light, texture, and graphic quality to a Storefront.
- Porcelain, cermaic, or glass tile in glazed or natural finishes may be used as accents and in limited field applications. Patterns over a large area must be sophisticated and well executed.
- Small intricate mosaic tile may be utilized for detail and accents only.
- Lapped or butt joints are not permitted. Outside cornered must be bull nose edge or special corner trim.
- Grout color should match the background color of the tile so as not to emphasise the grid.



> INTERIORS > LIGHTING / FLOORING

The store interior design should emphasize your merchandise and create an exciting experience for the customer.

It is the Tenant's responsibility to survey, capture and address all existing conditions within the space.

LIGHTING

Lighting can greatly contribute to the design of a Tenant's store, by emphasizing architectural forms as well as highlighting signage, adding color and visual drama to walls and other design elements. The creative use of dramatic lighting is encouraged at entries, show windows and merchandise displays.

- Fixtures must be positioned to avoid glare directed into public areas. Do not over light.
- Wall sconces or decorative lamping may be used to cast light onto storefront forms, provided that bare bulbs are not exposed and that the finish and form of these fixtures coordinate with the overall Storefront design. Fixture cut sheets are required.
- Sconces shall be commercial grade in quality and size.
- Residential scaled sconces are not acceptable.
- Colors are subject to Landlord approval.
- 2'x2' or 2'x4' prismatic fluorescent lights are not allowed.
- Track lights shall be finished to match the ceiling.
- Strobe, spinner, or chase type lighting is not permitted.



FLOORING

- Finished flooring is required in the full premises including in the recessed entry conditions and storage areas of the store.
- Hard surface base is required in all sales areas.
- Ensure floor material is durable and non-slip.
- Carpet must be commercial grade and meet local code required fire-proof ratings.
- Exposed concrete floors are permitted.
- Transitions between flooring and common areas must be flush.
- Tenant is responsible to mitigate any/all ADA issues and clear with the appropriate municipality.
- All glue-down flooring and carpeting must be installed on underlayment.
- No saw-cutting or trenching allowed without the prior written approval from the Mall Structural Engineer at the Tenant's expense.



> CEILING / WALLS & PARTITIONS

CEILING

- Stores 800 s.f or less must have a gyp board ceiling, not an acoustic panel ceiling.
- Recessed entry conditions must have a finished soffit matching the storefront.
- Concealed light covers to highlight architectural elements are encouraged.
- Multi-level ceilings are encouraged.
- Gypsum wallboard, concealed spline, decorative patterned ceiling panels, and other “high-tech” materials are encouraged.
- Standard 24” x 48” acoustical panels are not allowed in sales areas.
- Sprinkler heads are to be fully recessed in hard or acoustical ceilings.
- All ceiling material shall be non-combustible. No combustible materials may be used above the finished ceiling.

WALLS & PARTITIONS

- Demising walls are not designed to accommodate cantilevered or eccentric loads. If Tenant plans to use a demising wall for support of shelf standards, light soffits or heavy attachments, Tenant shall reinforce the wall as required by providing additional steel studs or independent supports for the shelf standards.
- Demising walls and ceiling shall be sound insulated to achieve a minimum STC rating of 50 by Tenants who produce above 80 dB (including but not limited to music stores, arcades, etc.) The Landlord will strictly enforce all Tenants’ right to quiet enjoyment of their Leased Premises.
- Tenant shall protect fire proofed columns and braces with gypsum board, and furr as required.
- The following are required for hair salons, pet shops and all food preparation type Tenants:
 - Walls containing “wet” areas to be constructed of metal studs with water resistant 5/8” type “x” gypsum board.
 - Demising walls of pet shops shall have sheet metal installed on studs, behind drywall, up 3’-0” from floor.
- When Tenant chooses not to install a ceiling within Tenant’s stockroom, Tenant shall extend the partition separating the stockroom from other areas of the store, to the underside of the structure above in order to isolate the stockroom from the sales area attic space. Tenant to verify if this is allowed by code.
- Metal or plastic laminate inserts are required for slatwall. No visible substrate at slats.
- Recessed wall standards are permitted.
- No open shelving with visible brackets or surface mounted systems are allowed.



> EGRESS DOORS / RESTROOM

EGRESS / SERVICE DOORS

- All secondary exit doors shall be backset so that the door does not swing into the corridor, or exit passageway.
- Doors entering a common exit passageway or corridor shall be labeled with the Tenant name and space number.

RESTROOM

- 3" Floor drain and cleanout are required.
- Each restroom must have an exhaust system tied to light switch.
- A waterproof membrane beneath the finish floor surface up to a height of 4" (12" minimum required) along all walls is required.
- Floor finishes in toilet rooms shall be ceramic tile with a coved 6" base. Tenant is required to provide a waterproof membrane beneath the finish floor surface up to a height of 4" along all walls.
- Toilet room walls and ceiling shall be constructed of metal studs with water-resistant 5/8" type "x" gyp board.
- Shut-off valve at eye level and labeled.
- All drain lines to be jetted at the end of construction
- Pressure assisted toilets are required in restrooms.
- Each restroom must have a sewer cleanout.

SUITE NUMBERS:

- Suite numbers on storefronts are required to be on the lower left hand corner, and shall consist of 6" white vinyl letters.
- Suite numbers are also required on the exiting back door to the Tenant spaces using 6" black vinyl lettering.



SIGN CRITERIA > CONTENTS

PRIMARY SIGNAGE

- CONTENT / DESIGN ELEMENTS*
- PLACEMENT / DIMENSIONS / CONSTRUCTION*

SECONDARY SIGNAGE

- WINDOWS / THRESHOLD*
- AWNINGS*
- PROHIBITED ELEMENTS*

EXTERIOR SIGNAGE

- LIGHTING / DIMENSIONS / DESIGN & FABRICATION*
- INSTALLATION / SPACE IDENTIFICATION*

SECTIONS OF INTEREST

- BUILDING DETAILS*
Includes property reference photos and specific Storefront design details.
- PROPERTY INFO*
Includes information on the Property's building codes, area permitting, and required contractors.
- SUBMITTALS*
Outlines requirements on how and what to compile for submittals to the Landlord for design reviews.
- ADDENDUM*
Includes additional info on exterior signage requirements.

Storefront signs are vital to the successful function of the Center.

The goal of this Criteria is to produce a colorful collage of signage that tastefully informs, delights, and stimulates the shopper.

All sign materials must be consistent with the design theme, enhancing the storefront and evoking a positive retail image.

Due to the variety of architectural treatments within the Center, each Storefront sign will be carefully considered in relationship to its particular location. What may be appropriate in one location may not work in another. Each proposed sign will be evaluated on its originality and compatibility with neighboring signs, and its overall image within the Shopping Center.

The Landlord reserves the right to disapprove any sign design that is not compatible with these criteria and the aesthetics of the Shopping Center.

This Criteria is intended to harmonize with the leasing documents. It is the responsibility of the Tenant to forward a copy of these Criteria to their architect, contractor and various consultants.

No deviation from the enclosed Criteria requirements will be accepted without prior written approval from Macerich.

Signage design and construction must be code compliant.



> PRIMARY SIGNAGE

Your primary sign is an opportunity to express your Brand's identity and individuality at the entry portal of your store.

The following sign types are encouraged as design options for your primary signage:

- **REVERSE CHANNEL (HALO LETTERS)** minimum of 3" deep and projected from the background.
- **INTERNALLY ILLUMINATED** sign housings having unique shapes with letters routed out and formed letters protruding beyond the routed out letter.
- **EDGE-LIT, SANDBLASTED GLASS** with a continuous light source.
- **CAST METAL LETTERS** raised or flush with the fascia surface.
- **GOLD LEAF** on glass or stone.
- **SILK-SCREENED** glass or metal panels.
- **INDIRECT ILLUMINATION** on non-internally illuminated signs (artisan type panel signs).

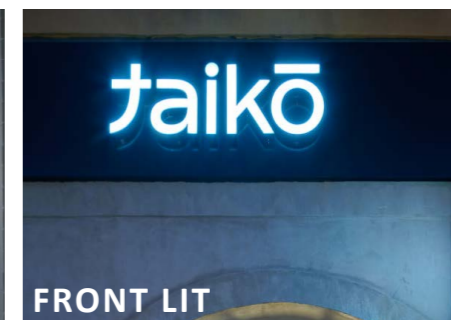

> CONTENT / DESIGN ELEMENTS

SIGN CONTENT

- Sign wording is limited to the Tenant's trade name and shall not include specification of merchandise sold or services rendered, regardless of the Tenant's legal name. Corporate crests, logos or insignia may be acceptable pending the Landlord's approval and provided they are part of the Tenant's name.

SIGN DESIGN ELEMENTS

- All primary Storefront signs must be illuminated. External illumination designs are subject to Landlord approval.
- Imaginative signs utilizing a variety of materials are encouraged. Adaptation of current sign practices may be necessary in order to comply with these criteria.
- Backlit components must be contained wholly within the depth of the letter. Maximum brightness may not exceed one hundred (100) foot-candles.



> PLACEMENT / DIMENSIONS / CONSTRUCTION

SIGN PLACEMENT

- One sign is permitted per store frontage unless additional signage is approved by Tenant Coordinator. Tenants occupying corner spaces may utilize one sign per elevation with a maximum of two (2) signs, or one sign on a diagonal corner. For unusually long tenant Storefronts, more than one sign may be allowed, with Landlord approval.
- Bottom of sign to be at 9'-0" A.F.F. minimum.

SIGN DIMENSIONS

- Signs shall be designed as an integral part of the storefront, with letter size and location proportional to the overall storefront design, and in compliance with the Design Criteria.
- Letter size: must be proportional. Max allowed for height of letter is 13% of overall storefront height. Example - a storefront that is 12'-0" in height will be allowed to have a maximum letter height of 18.72".
- Letter dimensions of greater proportions may be considered if, in the Landlord's opinion, the sign design is of exceptional merit and architectural quality.

SIGN CONSTRUCTION/INSTALLATION

- All Storefront signage and lighting, both interior and exterior, are required to be on a separate circuit and controlled by a time clock. Storefront signage and lighting are required to be on during operating hours and off during non-operating hours. This includes exterior building Storefront signage.
- Electrical raceways are not to be visible.
- High quality fabrications are required. Hums, flickers and light leaks are not permitted. Attachment devices, bolts, clips, threaded rods, fasteners, tubes, raceways, conduit, and other mechanisms are to be concealed. All labels must be away from public view. Signs must comply with all codes and regulations, must bear the UL label, and must have current sign permits.
- Tenant may use Landlord bulkhead for lateral bracing only.
- Threaded rods or anchor bolts shall be used to mount sign letters spaced out from background pane. Angle clips attached to letter sides will not be permitted. All bolts, fastenings, and clips shall be of hot-dipped galvanized iron, stainless steel, aluminum, brass or bronze, and no black iron materials of any type shall be permitted.
- Advertising placards, banners, pennants, names, insignia, trade-marks and other descriptive material may not be attached to the storefront or glazing.
- Visible weep holes and UL stickers are not permitted.
- Any existing holes from previous Tenant signage must be patched and painted.



> SECONDARY SIGNAGE

In addition to the Primary Sign, all signage visible from the exterior of the store are considered Tenant Signs. These do not include messages used to advertise products, sales, or special events.

Several various Secondary Signs are allowed at the Center and detailed in this section.

The following general Secondary Sign requirements must be met by all Sign varieties:

GENERAL

- Signs must be kept within the the lease line.
- Signs must be in proportion to the overall storefront and composition.

MESSAGING

- Trade name and/or logo only, are allowed.
- No taglines may be incorporated.
- Established logos will be allowed and will be counted in the overall area calculations.



> WINDOW / THRESHOLD

Secondary signage types and their requirements include:

STOREFRONT WINDOW SIGNS

If the Tenant wishes to provide additional Tenant identity, it is to be located at the pedestrian level on the inside face of the Storefront glass.

- Glazing signs are to be translucent (similar to frosted glass), reverse-reading and applied directly to the interior of the glass surface.
- Tenant graphics on Storefront glass shall be computer cut fat vinyl graphics (text/letter/logos)
- Maximum allowable area of signage is subject to Landlord's review and approval.
- Tenant graphics/logo will be limited to a maximum of three (3") inches in height.

THRESHOLD SIGNS

In addition to Storefront signs, Tenants are encouraged to incorporate signs into their entry way flooring. Landlord will review threshold signs on an individual basis.

- Threshold signs are to be graphics comprised of logos, crests and accent.
- Finish is to be flush with adjacent materials and consistent with entry flooring quality.
- Recommended materials are wood, tile, stone, metal and terrazzo inlays.
- Threshold signs are not to extend beyond their lease line into the Center.



> AWNINGS / BLADE SIGNS

AWNINGS

Some Tenant Storefront designs include projected awnings. Landlord will review awnings and their signage on an individual basis.

- Glass or metal are the preferred materials of choice, although fabric awnings will be considered.
- Awning signage may be considered as the main Tenant's identification at the sole discretion of the Landlord in the interior of the Mall only.
- Signage may occur on the valence of the awning and may be painted or silk screened in a contrasting color.
- Logos shall be silk-screened and submitted with awning and sign drawings. Size of the logo shall be proportionate to the overall width of the awning and subject to Landlord's approval.
- The lowest point of the awning or shade shall be a minimum of eight feet (8'-0") above the finished floor. It is the designer's responsibility to ensure that awnings conform to all applicable codes.
- Materials such as Pana-flex, plastic or other vinyl materials shall not be permitted.
- Awnings shall be cleared and maintained in good condition at the sole expense of the Tenant
- Wording on awnings is limited to Tenant's DBA only.



> PROHIBITED SIGNS AND MATERIALS

PROHIBITED SIGNS AND MATERIALS

The following sign types and materials are not permitted:

- Internally illuminated plexi-faced channel letters.
- Vacuum-formed or injection-molded plastic signs.
- Cabinet or standard “can type” signs with illuminated translucent backgrounds and silhouetted letters.
- Exposed skeleton neon applied directly to fascia element.
- Temporary or ‘sales’ signs attached to Storefront.
- Freestanding tripod signs.
- Flashing, scintillating, moving, sequencing, audible or odor producing signs.
- Paper, cardboard and Styrofoam signs.
- Credit card and advertising placards, decals, stickers or trademarks.
- Manufacturer labels.
- Carpet or rubber entry mat signs.
- Internally illuminated awnings.
- Signs employing un-edged or uncapped plastic logos or letters with no returns and exposed fastenings.
- No simulated materials (IE: wood grained plastic laminates, Zolatone etc.) or wall covering permitted.
- Signs painted on Storefront.
- No radioactive material shall be allowed to be used or installed as part of any Tenant construction scope of work. Furthermore, no radioactive signs such as Tritium exit signs shall be allowed in our Shopping Centers.

> EXTERIOR SIGNAGE > LIGHTING / DIMENSION / DESIGN & FABRICATION

The following additional requirements must also be followed regarding Exterior Signage:

LIGHTING REQUIREMENTS

- Metal letters, back lit (halo effect) with warm white light (3200K^o - 3500K^o). Letters must be a minimum of 6" in depth, and must be projected from the background with one inch spacers.
- Internally illuminated channel letters, with opaque sides and plastic faces, (3200K^o - 3500K^o) luminous tubing illumination within letters. Letters should not be more than 9" in depth. The Plexi-glass color will be determined on an individual mall basis. Trim caps are to match letter color.
- Letters are to be individually illuminated with white neon.

DIMENSION REQUIREMENTS

- Store sign shall not exceed 70% of the Storefront width, a distance which shall be determined by the lineal footage of the Tenants lease line.
- Logos cannot exceed 30" square depending upon the application.
- Uppercase letters shall not exceed 24" in height.
- Lowercase letters shall not exceed 20" in height

DESIGN AND FABRICATION REQUIREMENTS

- While the letters are to be individually illuminated with white neon, the "Plexiglas" color is to be determined on an individual mall basis. Trim caps are to match letter color.
- No exposed raceways, crossovers, conduit conductors, transformers, etc. shall be permitted.
- All signage and sign components shall be UL listed.
- All exterior signage components (logos and all individual letters) shall stand off the face of the wall surface by a distance of 1/4 inch. This shall be accomplished by the use of nylon spacers placed between the face of the wall and the back of the logo or letter.
- All metal letters shall be fabricated using full-welded construction.



If not already provided, Tenant is to request a copy of the City of Scottsdale approved Comprehensive Sign Plan. This plan will identify locations and types of signs allowed around the exterior of the center. All signage shop drawings must be submitted to Landlord, by the manufacturer, for review and approval, prior to submittal to the City.

> INSTALLATION / SPACE IDENTIFICATION

INSTALL AND CONSTRUCTION REQUIREMENTS

- All sign installation will be coordinated with the Landlord prior to initiation of any work by the Tenant and/or his subcontractors.
- Tenant is responsible for the operation of the Tenant's sign contractor.
- The sign contractor, on drawings submitted to the Landlord, shall indicate location of all openings for conduit sleeves and supports in sign panels of building walls. Sign contractor shall install signage in accordance with the approved drawings and building codes.
- Tenant's sign contractor shall repair any damage to any finishes caused by his work and any former sign penetrations if signband is to be reused.
- All signs, bolts, fastenings, and clips shall be of hot-dipped galvanized iron, stainless steel, aluminum, brass or bronze, and no black iron materials of any type shall be permitted. No toggle bolts shall be used for sign attachments.
- Electrical service to the Tenant's sign shall be installed by the Tenant and not be part of the Landlord's operating costs. The sign shall be controlled by a time clock.
- Any existing holes from previous Tenant signage must be patched and painted.

EXTERIOR SPACE IDENTIFICATION

- If Tenant has a non-customer door for receiving merchandise, Tenant must place its name and address on said door, using two inch (2") high block letters. Where more than one (1) Tenant uses the same door, each name and address may be applied.
- Tenant must install on the lower left side of the Storefront, as directed by the Scottsdale Fire Marshal's Office, only the numbers of Tenant's street address and only in such location as Landlord shall specify. Landlord's Tenant Coordinator shall also specify size, type and color of numbers at the Precon Meeting.



TECHNICAL CRITERIA > CONTENTS

ELECTRICAL

- POWER SOURCE / METER
- REQUIREMENTS / SYSTEM REUSE
- DATA & COMMUNICATIONS
- LIGHTING

LIFE SAFETY

- FIRE ALARM
- SPRINKLER / EGRESS

PLUMBING

- REQUIREMENTS
- GAS

MECHANICAL

- LOAD CALCULATIONS / GENERAL REQUIREMENTS / EXISTING SYSTEMS / EXHAUST
- ROOFTOP EQUIPMENT
- ROOFTOP DETAILS

STRUCTURAL

- DESIGN DETAILS

SECTIONS OF INTEREST

BUILDING DETAILS

Includes Property reference photos and specific Storefront design details.

PROPERTY INFO

Includes information on the Property's building codes, area permitting, and required contractors.

SUBMITTALS

Outlines requirements on how and what to compile for submittals to the Landlord for design reviews.

ADDENDUM

Includes additional info on exterior signage requirements.

The Inline Technical Criteria provides buildings details and design requirements for the Center's technical systems.

It is the Tenant's responsibility to verify existing conditions and comply with all applicable codes and standards for technical systems.

Tenants are required to adhere to the full Criteria during their design and construction.

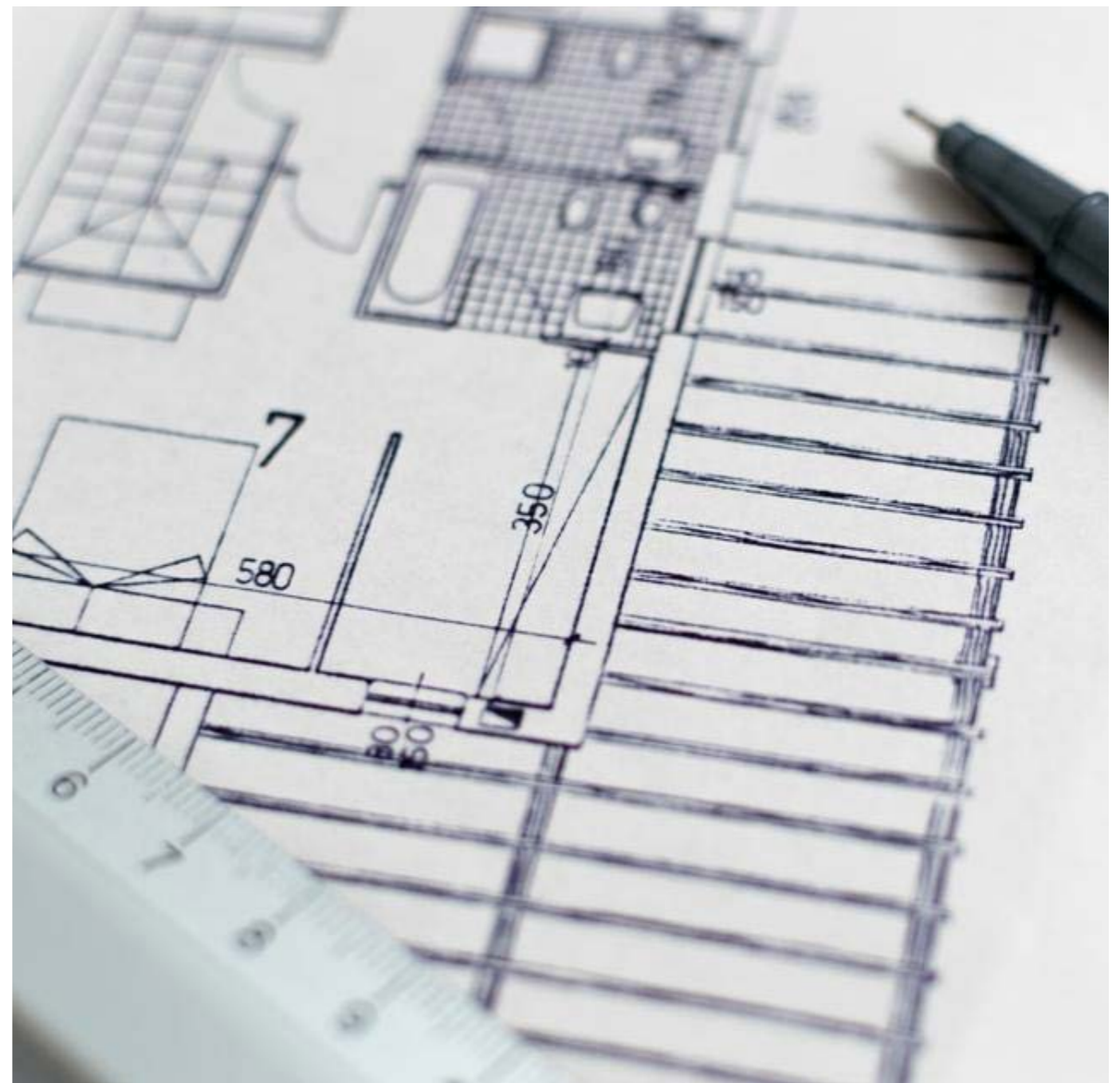

> ELECTRICAL > POWER SOURCE / METER

PROVIDED POWER SOURCE

Tenant shell spaces typically provide an empty conduit to a main power source. The main power source available for Tenant connections will be 277/480v, 3 phase, 4 wire available from the nearest electrical room.

I. TENANT REQUIREMENTS

Tenants are required to meet the following requirements related to connecting to their power source:

- **MAIN POWER SOURCE CONNECTION** must be performed by the Landlord's designated electrician, at the Tenant's expense.
- **FEEDERS** to the tenant space are the Tenants responsibility, installation of a dry type transformer, panels and complete distribution throughout their space.
- **LARGER CONDUIT**, if required, is a Tenant responsibility to install from the power source to the demised premises.

ELECTRICAL POWER

1. Landlord shall provide each Tenant space with either an empty 1-1/2" or 2" conduit with pull string originating from a 277/480 volt, 3 phase, 4 wire power source. Conduit size may increase for larger Tenants. The electrical service is based upon a maximum total load of 15 watts/square foot in Tenant space for Phase IV. For Phase II and III, the electrical service is based upon a maximum total load of 10 watts/square foot in Tenant space. Tenant power will be delivered from a central distribution point. The distribution point, in most cases, will be located remotely from the Tenant space. All work within the Landlord's distribution panels must be performed by the Landlord's required electrical contractor at the Tenants expense. This includes new breaker purchase and installation as well as feeder terminations. Tenant is responsible for providing all wiring from the distribution point to the Tenant's panel. Tenant's General Contractor to contract with the Landlord's approved electrician to make final tie-in at the mall's central distribution panel.
 - a. All Tenant panelboards and associated distribution equipment shall be provided by the Tenant. Note that transformation for any voltage other than 277/480 shall be furnished by the Tenant within the Tenant's space.
 - b. A main disconnect switch must be installed within the Tenant's space in order to provide the ability to isolate all electrical power within the space.
 - c. There must be an electrical disconnect switch at each VAV box and fan coil unit for service.
 - d. Each fan coil unit must have a combination starter/disconnect with an "H-O-A" switch.

- e. All fan coil units must be 480 volt, 3-phase and be fed from the electrical panel within the Tenant's space. Tenant is responsible for providing branch circuit(s) to 480 volt, 3 phase fan coil units within their space. Each FCU must be fed from a separate dedicated breaker.
 - f. FCU control wiring voltage must be reduced to 24 volts.
 - g. The Tenant's electrical contractor must provide 120 volt power to all VAV boxes on a dedicated circuit from the breaker panel within the Tenant's space. This breaker must have a lock installed in order to prevent accidental switching.
 - h. Restroom toilet exhaust fans must be tied to the light switch.
 - i. An electrical load calculation form can be found in the appendix of this handbook. The form must be completed and submitted to Landlord with the final Tenant plans.
2. The power source for retail spaces is normal power, derived from building service entrance section(s). The service utility is Salt River Project. There is no standby/ emergency power source available in the Tenant spaces. The normal power is not conditioned, filtered, or isolated, and does not have "transient voltage surge suppression" equipment.
 3. For tenants requiring an electrical submeter per their lease, please contact Mall Operations for a landlord approved type.
 4. Tenant breaker in Landlord House panel is to be replaced by Tenant as a part of electrical work during remodel, utilizing Landlord's required contractor.

METER DETAILS

Electrical use is charged by the Landlord by load study performed by the Landlord.

> REQUIREMENTS / REUSE

SYSTEM REQUIREMENTS

- **NO DIRECT ATTACHMENT** to the slab, roof deck, ductwork, piping or conduit above. Conduit and raceway hangers, clamps, light fixtures, junction boxes, supports, etc. must be fastened to joists and/or beams.
- **ACCESS PANELS** must be provided at all junction box locations and at smoke detectors above the ceiling.
- **IDENTIFY** all Tenant equipment in the Mall electric room with clear labels that include the Tenant name and space number.
- **TENANT EQUIPMENT** typically includes, but is not limited to: all outlet boxes, floor boxes, wire raceways, power/telephone poles, plug-in molding, wiring devices, and hanger supports for a complete distribution must be furnished and installed by Tenant.
- **EQUIPMENT POWERED BY TENANT** typically includes, but is not limited to: AHU, VAV units, water heater, store fixtures, signage, music systems and any other fixtures or equipment provided by Tenant.
- **FEEDERS** are typically the Tenant responsibility to the Tenant space.
- **UL LABELS** on all material and equipment must be new and of a commercial grade and where such labeling applies.
- **WATERTIGHT FLOOR BOXES** are required.
- **PULL BOXES/J-BOX MATERIAL** must be a minimum of 12 gauge galvanized steel outlets. Boxes in walls must be galvanized pressed steel or case metal. Caulk around boxes to eliminate noise transmission.
- **CONTROLS** including Manual or magnetic starters, switches, contactors, relays, time switches, safety devices, dimmers and other controls must be commercial type with heavy duty ratings and must be installed in strict conformance with the manufacturer's recommendation and applicable codes.
- **EXPOSED WIRING** is not permitted. All wiring of any type must be installed in conduit or must be metal clad cable (MC). Metal clad cable will only be allowed for concealed branch circuit wiring within the demised premises. Flexible conduits must be used for connections to vibrating equipment.
- **COPPER** is required for all wiring.
- **CONDUIT** is required for all wiring, including low voltage.
- **GROUND SYSTEM TO BUILDING STEEL** as structure is designed with a "UFER" grounding system.
- **SLAB TRENCHING** is not permitted. Coring is permitted with approval from Mall Structural Engineer, solicited by Tenant Contractor.
- **GRADE LEVEL SLAB** requires electrical conduit to be installed at least 4" under the slab with Schedule 40 PVC conduit. Conduit must not be installed in the slab or less than 4" below slab.

> DATA & COMMUNICATIONS / LIGHTING

DATA AND COMMUNICATIONS – INSTALL AND PROVIDER REQUIREMENTS

Telecommunications service is provided and administered throughout the Center by Granite Grid. The service includes a dedicated concierge customer service representative for each Tenant, high-bandwidth service (tailored to suit Tenant demand), centrally coordinated installations, moves and repairs.

- **ACCOUNT SETUP AND SERVICE INSTALLATION** is the Tenant responsibility to coordinate direct through Granite Grid. Other data providers are not permitted at this property as they do not have an access agreement in place. ****It is highly recommended to coordinate service install a minimum of 4 weeks in advance.**
- **TELEPHONE DEMARC WORK** must be performed by Landlord's approved telephone subcontractor.
- **TELEPHONE SERVICE** is the Tenant responsibility to contact the local Telephone Company and install within their premises.

LIGHTING – SYSTEM REQUIREMENTS

- **LIGHTING IN TENANT SPACE** is the Tenant's responsibility. The Tenant will not install any lighting outside the Tenant's space with the exception of Mall required standard lighting at back doors. These fixtures shall be photo cell controlled.
- **LIGHTING SCHEDULE** is required for review in conjunction with a reflected ceiling plan.
- **TIME CLOCK** is required to control display window lighting and be on during the hours the Shopping Center is open.
- **DISPLAY WINDOW LIGHTING** at the ceiling must be glare-free and at approved levels at the storefront glass line and not hang down below the top of storefront glass.
- **RECESSED INCANDESCENT DOWN LIGHTS** are permitted.
- **DECORATIVE LIGHTING FIXTURES** for storefront illumination, such as luminous ceilings, chandeliers, pendant or wall units or clear type glitter strips are permitted if approved by Landlord. No strobe, spinner or chase type lighting shall be used.
- **CODE REQUIRED LIGHTING** such as exit, emergency and night lights must be provided throughout.
- **SALES AREA FLUORESCENT LIGHTING** must be recessed and must use metal parabolic louver type lenses with a minimum of 18 cell configuration for a standard 2' x 2' fixture. Bare lamp fluorescent or fluorescent fixtures with acrylic prismatic lenses may be used only in concealed areas or stock rooms.
- **TRACK LIGHTING** may be used if the track is painted to match the ceiling color.
- **LIGHTING CONTROL SYSTEM** is the Tenant responsibility, including connection to the Building Management system and connection to the Fire Alarm system.

> LIFE SAFETY > FIRE ALARM

FIRE ALARM REQUIREMENTS

- **FIRE ALARM DETECTION SYSTEM** is a Tenant responsibility to provide within the Tenant space as an extension of the Landlord's building-wide addressable fire alarm system.
- **FIRE ALARM INSTALLATION** must be performed by the Landlord's designated contractor.
- **FIRE ALARM TIE-IN** to the building wide addressable system must be performed by the Landlord's designated contractor.
- **OCCUPANT NOTIFICATION** must be provided within tenant spaces (on a tenant-by-tenant basis) that exceed the Code's thresholds based on the occupancy classification of the individual tenant space.
- **LANDLORD SHALL PROVIDE** each Tenant space with junction boxes and wiring originating from a Simplex 4100-U transponder panel with voice evacuation, strobe, and True Alarm Addressable "Class B" initiating circuits.
- **TENANT SHALL BE RESPONSIBLE** for providing fire alarm devices and wiring complying with National, State and Local Codes and with the Americans with Disabilities Act (ADA). These devices shall include, but not be limited to, the following:
 - Simplex Series 4903 combination speaker strobes
 - Simplex Series 4098 photoelectric duct mounted smoke detectors for all fan coil unit supply ducts.
- **SCOTTSDALE FIRE DEPARTMENT** in conjunction with Scottsdale Fashion Square have implemented a phased program to upgrade the emergency voice communication system as well as the emergency visual communication system to meet current code requirements.
- **NEW TENANTS** and tenants renewing their leases shall be required to include the following scope of work at the time of signing a lease:
 - Add Fire Alarm Speakers to bring the fire alarm notification level to a minimum of 90dB and to increase the audibility of the message to an acceptable level.
 - Add Fire Alarm Strobe Notification Devices throughout the Suite to meet current ADA and Code standards and to allow synchronization with the common area strobes.
 - Add relay to shunt power to the tenant music system in the event of an alarm. Connection to music system (as well as any music system reset; shall be by tenant's music equipment supplier.
 - Add control equipment as required to power the above equipment and tie it into the existing Simplex Fire Alarm System. Dedicated 120v power to any required amps, NACs or controllers shall be by tenant's electrical contractor.
 - Fire alarm shall be in conduit; conduit and boxes shall be provided by the tenant's electrical contractor.
- **TENANT SHALL BE RESPONSIBLE** for system programming and testing. Further information regarding programming, testing, scheduling, etc., can be obtained from approved subcontractor (see required subcontractor's list).
- **ENGINEERED DRAWINGS** of existing and new fire alarm devices, load calculations and tie-in to mall fire alarm system is required at Tenant's expense. This must be performed by the Landlord's required fire alarm contractor.
- **FOOD COURT TENANTS** shall be responsible for connecting exhaust hood fire suppression system(s) into the building fire alarm system. This work must be performed by the Landlord's required fire alarm contractor and Tenant's expense.
- **THE FIRE ALARM SYSTEM** devices, installation and interface to the existing Scottsdale Fashion Square Simplex fire alarm system shall be provided by Johnson Controls (no exceptions).
 - Contract and coordinate fire alarm system design, material and device installation through Johnson Controls. Contact Johnson Controls @ (602) 284-0777 no later than six weeks prior to occupancy date.
 - To allow time for the City of Scottsdale fire alarm plan review process, it is required that Johnson Controls have a signed contract from the General Contractor for fire alarm services no later than five weeks prior to the scheduled occupancy date.

> LIFE SAFETY > SPRINKLER / EGRESS

SPRINKLER SYSTEM REQUIREMENTS

- Any Thin-walled XL Galvanized Piping must be replaced with Schedule 10 Ductile Steel Piping by Landlord's required contractor at Tenant's expense.
- **SPRINKLER MODIFICATIONS** are the Tenant's responsibility, designed and installed in accordance with NFPA 13.
- **SPRINKLER DESIGN AND INSTALLATION** must be performed by the mall required sprinkler contractor.
- **DESIGN CONTROL AREA** requires flush mount heads.
- **FIRE EXTINGUISHER REQUIREMENTS** are the Tenant's responsibility to confirm with the local or state fire marshal relating to quantity and location of fire extinguishers. At minimum, Tenant is to install at least one wall hung, 2A 10BC dry type U.L.- listed fire extinguisher.
- **PIPING** must be as close to walls and as high to underside of roof framing as possible.
- **LANDLORD NOTIFICATION** is required in writing at least 24 hours in advance of making any modifications to the sprinkler systems. Contractor must notify the fire department and any alarm monitoring company for verification that the system is fully drained. The contractor must notify the Landlord when the system is back on line.
- **CLEARING ALARMS** must be coordinated with Security or Mall maintenance supervisor at least 60 minutes prior to any drain down. Contractor shall remain for one (1) hour after the system has been refilled to check for leaks or other problems.
- **OVERNIGHT DRAINING** is not permitted. All systems have to be charged and operational when worker leave for the night.
- **SPRINKLER WORK HOURS** must be done between 7:00 AM and 4:00 PM Monday through Friday, so the fire system can be filled and tested by 5:00 PM. See the Tenant Contractor's Rules and Regulations for the cost for each shut down of the system, which is required to be paid before the system is drained. The Mall staff or approved contractor will drain and fill the system.

EGRESS REQUIREMENTS

- **FIRE BARRIER FROM ADJACENT SPACE** must be separated by at least 1-hour fire barriers with 60 minute opening protectives.
- **FIRE BARRIER FROM EXIT STAIR DISCHARGE** must be separated by 2-hour fire barriers with 90 minute opening protectives.
- **AUTOMATIC SPRINKLER SYSTEMS** must protect passageways.
- **SMOKE DETECTION SYSEM** must protect passageways.
- **GAS PIPING**, if distributed along the exit passageway routes, will be separated from the exit passageway by fire rated construction and will not be considered to be located within the exit passageways.
- **ALLOWED UTILITIES** in exit passageways are limited to; Electrical wiring (no higher than 480 volts phase-to-phase and 277 volts phase to-neutral) in electrical conduit, Low-voltage wiring (security, music, telephone, data, etc.), enclosed junction boxes, Fire alarm equipment and wiring, Noncombustible piping, and Mechanical ductwork.
- **PROHIBITED UTILITIES** in exit passageways include; Electrical equipment such as panels, switchgear, and transformers, Grease traps, and Natural Gas piping.

> PLUMBING > METER / SYSTEM REQUIREMENTS

SYSTEM OVERVIEW

Tenant shell spaces are typically provided a domestic cold water line and sanitary line stubbed into the space.

The following criteria must be followed during the design and construction of the Tenant space:

WATER METER REQUIREMENTS

- **INSTALL** must be in location approved by Operations Manager.

SYSTEM REQUIREMENTS

Prior to or during construction all tenants must scope and camera the sanitary lines exclusively serving the premises and provide the results to the Tenant Coordinator and Operations Manager. Any defective lines must be replaced.

PHASE II & III:

The following criteria is provided for the purpose of designing the Tenant's plumbing. This criteria is provided as a guideline for Tenant's Engineer. It is the Tenant's responsibility to verify existing conditions and comply with all applicable codes and standards.

1. Landlord shall provide the following:
 - a. Valved cold water stub out for the demised premises. This stub out shall be located either in the Tenant space or exposed in the adjacent service corridor.
 - b. Sanitary sewer located below the floor slab for Tenant spaces located on grade or below the floor in lower level ceiling space for Tenants located above the Service Level or on the First & Second Levels.
 - c. Vent piping located either in the Tenant space or exposed in the adjacent service corridor.
2. Tenant shall provide the following:
 - a. Connections to cold water supply stub out. If Tenant requirements exceed the stub outs provided, the Tenant shall notify Landlord and obtain Landlord's written approval to any modification of furnished supply system.
 - b. All plumbing fixtures including, but not limited to the following: waterclosets, urinals, floor drains, showers and lavatories as required plus all associated water, waste and vent piping to owner furnished stub outs.
 - c. Note: Tenant shall insure that all water closets within their space are a "pressure assisted" type at the Tenant's expense. All plumbing fixtures shall be "Water Saving" type in accordance with City of Scottsdale requirements.

SUB-METER

A. Applicable Utilities: Water

- Tenant water sub-meters should be installed for Tenants that are at sub-meter properties, properties who have "meter reads" listed as their primary billing method in the Property Utility Redistribution Summary.
 1. A sub-meter is not required for a utility if:
 - * The tenant is directly metered by a local utility company and pays them directly for utilities
 - * A utility is not supplied by the Landlord to the Tenant's space
- Tenants who require sub-meters to be installed, may choose from the approved sub-meter options provided by the Landlord. There are two sub-meter options for each utility. Spec sheets are attached.
- Location and Placement of Sub-Meters: Sub-meters must be placed in a location that is easily and safely accessible by the property management team or their representative.

For tenants requiring a water submeter per their lease, please contact Mall Operations for a landlord approved type.

> PLUMBING > WATER EFFICIENCY

WATER EFFICIENCY

- The Tenant is required to install waterless urinals in tenant restrooms when urinals are used.
- Low-Flow water closets using 1.6 GPF or less gallons per flush will be installed in all tenant spaces.
- Operation sensors and low-flow heads using 0.5 GPM or less in lavatories.
 - * Domestic Tank-type or Instantaneous Water Heaters and associated piping and valving.
 - * Tenant shall provide a main water shut off valve located at eye level in a wall behind a labelled access door. Locate in or near employee restroom as designated by Landlord.
- In the event that the Tenant requires sanitary sewer connections in locations other than where sanitary sewer lines exist, all work associated with connection to sanitary sewer shall be Tenant's responsibility and subject to Landlord's approval. Removal and replacement of existing floor slabs shall be in accordance with approved construction practices.

Note: Phase IV - Tenant's located on the First Level over Camelback Road and over the Ring Road shall be restricted to the area where waste piping can run due to the height restrictions for sloping piping.

- Any relocation of basic utility services within the Tenant's space shall be the Tenant's responsibility, subject to written approval by the Landlord.
- All toilet areas and other areas with plumbing fixtures shall be provided with self-priming floor drains. Flooring in these areas must have a waterproof membrane installed with the edges running no less than 4" up each affected wall and out 18" from door line. This membrane will be water tested by the General Contractor and inspected and signed off by Mall Personnel. If the membrane fails the water test, it must be replaced.
- A water shut-off valve must be installed in the space at eye level, using a ball type valve to isolate all domestic water within the space. This valve must be clearly labeled "Water Shut Off Valve". If the Tenant's water requirements exceed the Landlord provided water supply to the space, the Tenant will notify the Landlord, and obtain the Landlord's approval prior to any modifications to the existing supply system.
- A water meter must be installed to record all domestic water usage for all restaurants, hair salons, nail salons and pet stores. The meter must be installed at eye level or have a remote reader placed at eye level, All water meters must read in gallons.
- All fire sprinkler work must be performed by the Landlord's required contractor at the Tenant's expense.
- Tenant restroom toilet exhaust must be motorized with a backdraft damper and connected to the Landlord's common exhaust duct. Exhaust fan must be tied to light switch.

- In no case shall any products containing lead be used for piping or connections - including fluxes and solders used in pipe joinery. The following criteria is provided for the purpose of designing the Tenant's structural drawings. This criteria is provided as a guideline for Tenant's Engineer. It is the Tenant's responsibility to verify existing conditions and comply with all applicable codes and standards.
- Complete Engineered drawings must be submitted to the Landlord's Tenant Coordinator for review and approval. Landlord will review the plans for conformance to basic Mall requirements. The Landlord does not review for design, nor does the Landlord accept responsibility for the Tenant's adherence to governing codes.

> GAS

GAS SERVICE

Gas service is available at the Center only for Food Service Tenants. If available, Tenant, at its sole cost and expense and in compliance with local code must procure gas service to and within the demised premises and will make all necessary arrangements with the local Gas Company for such service.

I. SERVICE REQUIREMENTS

- **GAS METER INSTALLATION** at gas meter header is the responsibility of the Tenant.
- **GAS PIPING INSTALLATION**, when allowed, is the responsibility of the Tenant to provide and install. Roof piping must be placed on pillow blocks or similar arrangement. All roof repairs to be by the Landlord's required roofer at Tenant's expense.
- **PRESSURE REGULATORS** required for connection to Tenant's equipment is the responsibility of the Tenant. Coordinate with Landlord for regulator vent routing.
- **MANUAL SHUTOFF DEVICES** are required for the entire gas piping system and equipment or fixtures and color coded or identified as such as required. Valves must be: UL- approved; FM-approved; or, ACSE 25-compliant. All new development and newly tenanted restaurants need to have gas shut-off valves installed on Landlord side of the meter, at each individual space.

> MECHANICAL > LOAD CALCS / GENERAL / EXISTING / EXHAUST

Tenant spaces must provide stand-alone HVAC systems through package rooftop units placed directly over their space.

LOAD CALCULATIONS

- **HEATING LOAD CALCULATION** must maintain the minimum space temperatures in sales and public spaces of 68 degrees F and 50 degrees F in non-public spaces.
- **COOLING LOAD CALCULATION** must maintain the minimum space temperature of 73 degrees F and a maximum of relative humidity of 55 degrees F and shall take into account all interior heat producing items such as people, equipment, roof and exterior walls.

GENERAL REQUIREMENTS

- **VIBRATION ISOLATORS** are required to be installed on all HVAC equipment, whether on the roof or within the Tenants space.
- **MAXIMUM NOISE** criteria of NC40 is required for all spaces except kitchens and other similar work areas.
- **DUCT MOUNTED SMOKE DETECTORS** are required for systems that total 2,000 CFM or greater and must be connected to the main fire alarm panel, if applicable. Each duct smoke detector must have a remote key operated reset/test device mounted with in the Tenant space and an addressable relay module. Use Landlord's designated contractor for connection to the main fire alarm loop. The cost associated in monitoring Tenant's space will be the Tenant's responsibility and will be included in Tenants monthly billing.
- **AIR AND WATER BALANCE REPORT** is required prior to closing out construction and will be performed by an independent test and balancing agency at the sole cost and expense of the Tenant.
- **CONDENSATE LINES** from HVAC units must be copper, run at right angles, drain into the Tenant space, and (if applicable) secured to the roof per mall required roofer's specifications.
- **FIRE DAMPER ASSEMBLIES** (including sleeves and installation procedures) must be UL listed and approved by the building inspector preceding installation. Install duct and ceiling access to fire dampers. Smoke detectors may be required in all return air or exhaust ductwork. The detectors will over ride and shutdown the air handling equipment when smoke is discovered.
- **FIBERGLASS DUCTS** are not permitted for HVAC trunk lines. Flex duct is permitted for run outs within the Tenant premises and is limited to a maximum distance of 4'.

EXISTING SYSTEMS

The Lease may allow some Tenants to reuse existing HVAC system equipment. In such cases, the following requirements must be followed:

- **CONFIRM** the existing system meets the Tenant Criteria requirements.
- **REPLACE** any units the Landlord deems in need of replacing. This may occur anytime during the terms of the Lease. Replaced units must adhere to the Tenant Criteria.
- **REUSE** of equipment older than 5 years is not permitted.
- **ALTERATION** of the existing system must be submitted and approved by the Landlord.
- **SUBMIT DOCUMENTATION** of the following prior to opening:
 1. A letter from an HVAC contractor asserting that the HVAC unit(s) operate in "like-new" condition.
 2. A copy of the maintenance agreement for the unit(s).
 3. Photographs of the existing unit(s) provided by the Tenant's HVAC maintenance contractor.

EXHAUST REQUIREMENTS

- **ODOR PRODUCING TENANTS** such as restaurants, pet shops, hair salons, nail salons, and the like must maintain 10% negative air pressure with respect to the Mall by providing make-up air equal to 90% exhaust air volume.
- **SEPARATE MAKE-UP OUTDOOR AIR SYSTEM** may be required to balance Tenant's exhaust system. Spaces that require exhaust must be designed to provide negative air pressure relative to adjoining conditioned spaces to prevent odor transfer.
- **ROOF MOUNTED EXHAUST FANS** must be ducted to ceiling grilles located approximately in the center and rear of the demised premises and specifically near the area where the odors are generated. The system shall be designed to cause the exhaust air to gravitate from the Mall common area to the odor producing area and then exhausted out.
- **EXHAUST FANS** must be interlocked with the light switches for the store customer service area.
- **OPERATION** of the combined HVAC and exhaust system must be on during all hours that the Tenant is open for business.
- **STORE EXHAUST SOLUTIONS** shall not include air filtration systems or bathroom exhaust fans.

> EXHAUST / ROOFTOP EQUIPMENT

SPECIFIC REQUIREMENTS FOR ODOR PRODUCING TENANTS

- **ODOR PRODUCING AREAS** must include the necessary equipment to remove any odors. This work will be approved in writing by the Landlord and at the sole expense of the Tenant. Examples of such Tenant's include; hair or nail shops, pet shops, and food preparation shops.
- **SPECIAL MAKEUP AIR** as required by special conditions such as grills, restaurant exhaust systems, etc., will be provided by the Tenant. Along with the HVAC unit, the Tenant may use an evaporative cooler.
- **SMOKE DETECTORS** may be required in all return air or exhaust ductwork to override the air handling equipment and provide shutdown when smoke reaches the equipment.

KITCHEN EXHAUST REQUIREMENTS

- **LANDLORD REVIEW** is required to ensure the exhaust does not compromise the ventilation air of adjacent mall roof top units.
- **EXHAUST FAN** must be a SWSI centrifugal fan which must be fitted with a minimum 10' stainless steel upblast. Guy wires must be attached to the roof in order to secure the stack. Use the mall roofer for connection of the guy wires at Tenant's expense.
- **GREASE GUARD CONTAINMENT SYSTEM** (or approved equal) must be installed to protect the Landlord's roof. A quarterly maintenance program must be in-place for the grease containment units. Proof of the maintenance contract must be presented to Operations Manager prior to the store opening.

ROOFTOP EQUIPMENT REQUIREMENTS

- **PIPING** for the rooftop equipment must be provided and installed by the Tenant in coordination with the Landlord.
- **INSTALLATION INFRASTRUCTURE** including all curbs, supports, lintels, pipes, ducts, vent caps, air inlets, exhaust hoods, louvres, flashings, counterflashing's, etc. are the Tenants responsibility.
- **CURB ADAPTERS** are only permissible at the discretion of the Landlord.
- **PAVERS** must be placed around the roof top equipment and from the main pathway to the equipment in order to protect the roof from traffic.
- **EQUIPMENT SCREENS** for rooftop shall meet Landlord requirements. All equipment must be hidden from public view from the parking lot per City of Scottsdale.
- **PAINTING EQUIPMENT** including screening, equipment, ductwork, and piping is required to match the roof deck per Landlord specifications.
- **ROOF MEMBRANES** are required for mounted grease exhaust equipment and shall be

a single 60mil sheet of TPO roof membrane, loose and laid over the base mall primary roof membrane. This additional sheet of TPO shall be installed minimum 5' beyond all roof top kitchen equipment and help in place by concrete pavers at the corners and or as required to keep the membrane in place and afford the ability to replace as necessary when it becomes soiled.

- **LABELS** are required on all Tenant equipment.
- **ABANDONED EQUIPMENT** must be fully removed, including any associated curbs and patched accordingly.
- **120-VOLT OUTLETS** are required for all HVAC units from the Tenant's electrical service mounted to the unit on the rooftop.
- **EXPOSED DUCTWORK** is not allowed on the roof.
- **WEATHERHEAD** is required when multiple A/C refrigeration lines penetrate the roof.
- **SEAL NEW PIPE PENETRATIONS** though the roof with new prefabricated lead or metal pipe sleeve flashing. Flashing flanges should be installed in a manner acceptable to the roofing manufacturer and the Landlord.
- **CONTROL AND ELECTRICAL WIRING ROOF PENETRATIONS** shall be made through the equipment curb or roofer required flashing.
- **ROOF TOP EQUIPMENT** must not be visible from inside the mall or the parking lot.
- **ROOF CURBS** must utilized under, and walking pads must be installed to, and around all associated roof top equipment.
- **ALL ROOFTOP WORK** must be performed by the Landlord's required roofing contractor at Tenant's expense.
- **ALL SATELLITE DISHES** and antennas must be approved by the Mall Management prior to installation. If approved, all antennas and dishes must utilize a sled mount , with a slip-sheet installed underneath, between the roof top and the sled. The Tenant must submit load calculations to the Landlord. These calculations must show the total weight applied to the rooftop as well as what wind shear that this weight corresponds to. Roof top penetration must be approved by the Landlord and sealed by landlord's required roofing contractor at Tenant's expense. All rooftop penetrations for cabling must utilize a weather-head.

> ROOFTOP EQUIPMENT

I. ROOFTOP EQUIPMENT LOCATION REQUIREMENTS

- **VISIBILITY OF EQUIPMENT** from parking lots or adjacent streets is not permitted. Locate all roof top equipment as far from side walls as possible. Otherwise, equipment must be screened.
- **DISTANCE BETWEEN FRESH AIR INTAKE AND EXHAUST** units shall be a minimum of 15’.
- **FRESH AIR INTAKE** cannot draw in from Tenant exhaust. It is the sole responsibility to design and locate the distance such that Tenant’s exhaust cannot be drawn into the Fresh Air Intake of ANY existing roof top equipment.
- **DISTANCE ROOF PENETRATIONS** so that they may not be so close to one another that they interfere with proper flashing, or be installed in any roof waterway or area of the roof which ponds water. If placement of any curb or platform causes restriction of water flow and/or creates a ponding situation, a cricket will be constructed at the upslope side of the curb. Crickets can be formed from Perlite roof insulation to provide a minimum slope of 1/4” per foot.
- **DISTANCE BETWEEN NEW IMPROVEMENTS** and existing parapet walls, equipment curbs, or any rooftop projection, should be no less than 24” to allow for proper flashing and sealing of the roof membrane.

II. ROOFTOP STRUCTURAL REQUIREMENTS

- **STRUCTURAL ENGINEER** registered in the state in which the work is being performed must be used to design and evaluate equipment placement and provide structural drawings and detail for Landlord’s review.
- **LOCATE** roof top equipment over major structural elements.
- **NORDSTROM WING ROOFTOP EQUIPMENT** is to be installed within a specific roof zone designed to carry the additional weight. Check with the Operations Manager or Tenant Coordinator as to the exact location of the zones in this area.
- **REINFORCE** the roof system to adequately support the weight of any equipment added.
- **REMOVAL** of structural or miscellaneous bridging, blocking, etc., is not permitted.
- **MODIFICATIONS** to the existing structure must be approved by the Landlord before any work begins.
- **AT WORK COMPLETION** the Tenant’s structural engineer shall submit a letter stating that the roof top equipment has been installed in accordance with the engineer’s recommended design.
- **REMOVE AND DISPOSE** existing rooftop equipment that is not being used by the Tenant at the Tenant’s expense.

III. PLACEMENT NEAR SOLAR PANELS REQUIREMENTS

- **DO NOT PLACE** equipment within 10 feet of any solar inverter or AC junction box.
- **AVOID INTERFERENCE** with solar panel production by placing objects no closer than the distance defined as 2 times their height. For example, if a 4 foot HVAC unit is installed, it must be located at least 8 feet away from a solar panel. However, in no cases, regardless of the height shall an obstacle be placed within 3 feet of solar equipment.
- **DO NOT ADD** conduits, pipes or other devices to existing conduit carrying devices.
- **DO NOT ROUTE** wires, pipes or other devices across or over existing solar equipment.
- **LANDLORD MUST REVIEW AND APPROVE** all modifications within 20’ of solar equipment.

IV. ROOFTOP WORK

- **MALL APPROVED ROOFING CONTRACTOR** is required for all roof work throughout the center.
- **WARRANTY COMPLIANCE** is the responsibility of the Tenant and mall roofing contractor.
- **ROOF ACCESS** shall be coordinated and scheduled through Mall Operations.
- **DAMAGE** to the roof structure caused by hoisting installation and the maintenance and/or servicing of Tenant’s equipment will be the sole cost and expense of the Tenant to repair.
- **QUALITY OF WORK** is subject to inspection by the Landlord and, if found unsatisfactory, reject.
- **WELDING BLANKETS** are required blankets to protect Landlord’s roof during any welding on the roof level.
- **WELD INSPECTIONS** may be required at the sole cost and expense of the Tenant.
- **COATING** on all materials, welds, connections, etc. installed by Tenant for the HVAC system is required to withstand corrosion.
- **WORK DURING INCLEMENT WEATHER** is not permitted. Tie-in of flashing materials to moist or dusty surfaces should not be attempted.
- **RESTRAIN** all electrical conduit, metal pipe, or plastic piping to appropriate sized wood blocking set into roofing cement. Attachment to blocking should allow for movement due to thermal expansion and contraction.
- **USE APPROVED ROOFING CONTRACTOR** to tie in platforms, curbs, and sleepers into the existing roof membrane, at the sole cost of the Tenant, in a manner acceptable to the roofing manufacturer and the Landlord.

> HVAC DESIGN CRITERIA

The following criteria is provided for the purpose of designing the Tenant's Mechanical/HVAC system. This criteria is provided as a guideline for Tenant's Engineer. It is the Tenant's responsibility to verify existing conditions and comply with all applicable codes and standards.

COOLING:

- Landlord's cooling system has been designed to the following specifications:
- Cooling Criteria:
- Summer Outside Air: 108°F
- Stores Space Temperature: 78°Fdb. 55% RH
- Mall Common Area Temp: 80°F. Relative Humidity: 55%

Air volumes within retail stores must be minimum 1.75 CFM / Sq.Ft.

****Cooling is provided to accommodate mall hours only****

HEATING:

Heat is not allowed.

AIR QUANTITY:

Landlord provided outside air is not conditioned for temperature. The Landlord outside/fresh air duct is located within the Tenant space or exposed in the adjacent Tenant service corridor. Tenant shall be responsible for the installation of any necessary ductwork between the Tenant a/c unit and the Landlord's main trunk.

Phase II & III:

20% outside air or 15 cfm per person, whichever is greater. 80% recirculated.

Phase IV:

10 cfm outside air per person

TOILET VENTILATION:

Landlord toilet exhaust air main trunk line is located within the Tenant space, or exposed in the adjacent Tenant service corridor. Tenant shall be responsible for the installation of any necessary ductwork between the Tenant a/c unit and the Landlord's main trunk.

CHILLED WATER:

Chilled water is provided during normal Mall operating hours. Design Temperatures: 50°F Entering Water Temperature, 64°F Leaving Water Temperature. Landlord's system is controlled to maintain an end-run differential pressure of 15 psi.

Phase II & III:

Phase II & III mall chilled water gpm averages are around .013 gpm / Sq.Ft. Max. gpm to any fan coil unit is in the mid-twenties. If the space requires more gpm, then more fan coil units must be installed. Booster pumps are not allowed.

Phase IV:

Phase IV mall chilled water gpm averages around .012 gpm / Sq.Ft. Booster pumps are not allowed.

Max. Lighting Loads:

7watts / sq. ft.

MAX OCCUPANCY LOAD:

75 sq. ft. / person Costs for additional cooling capacity will be the responsibility of the Tenant and subject to the Landlord's approval.

> HVAC DESIGN CRITERIA

FAN COIL UNIT SPECIFICATIONS & REQUIREMENTS:

1. Tenant must replace existing fan coil units serving their space with new if existing units are over 10 years old. All new fan coil units must be either Carrier 39L or Trane (UCCA or CSAA) series units FCU must be a conventional belt driven model. VFD's are not allowed. If existing fan coil unit is less than 10 years old, the unit must be completely refurbished by the Landlords approved Mechanical Contractor at the Tenant's expense. See Landlord's Required Contractor list for vendor information.
2. All fan coil units within the Tenant's space must have a secondary drain pan installed underneath each unit.
3. All fan coil units must have a strainer and circuit setter installed at each unit with a pressure / temperature plug installed on the inlet and outlet of the system, as well as across the strainer. The strainer must have a ball type isolation valve installed at the drain port for service.
4. All fan coil units must have an automatic air vent installed with the discharge piped to the condensate drain. A ball type isolation valve must be installed between the air vent and chilled water line. Air vents must be installed at the highest point of the supply waterline.
5. Each fan coil unit must have isolation valves installed on both the supply and return chilled water lines. A ball type isolation valve must be used. Chilled water lines to each fan coil unit must be insulated with fiberglass insulation.
6. All fan coil units must have disposable 2" pleated air filters. All units must accommodate one or more of the following filter sizes in any combination: (16x20x2, 16x25x2, 20x20x2, 20x25x2)
7. Fan coil units are not allowed to share taps off of the main chilled water loop. Each fan coil unit must have a dedicated tap off of the mall's main loop. All new taps must be performed by the Landlord's required Mechanical Contractor, at the Tenant's expense. See Landlord's Required Contractor list for vendor information.
8. The fan coil unit must not have anything attached to it, nor within two feet around each unit. This includes all conduits and piping of any kind that is not directly for the unit. The unit must not be up against any walls or other structural members that would not allow for the minimum 2' - 0" of clearance around the entire unit.
9. All condensate drain lines must use copper piping. PVC piping will not be allowed. A union type fitting must be installed in the condensate drain line within 18" of the fan coil unit. All condensate drain lines must be piped separately to a floor sink within the Tenant's space, if possible. The drain line must be insulated with fiberglass insulation. Condensate pumps are not allowed. Condensate drains on draw-through units must have a p-trap equal to the negative static pressure plus one inch. Condensate drains on blow-through units must have a p-trap equal to the fan total static pressure.
10. Chilled water valve must be purchased through the Landlord's required controls contractor, and installed by the Tenant's mechanical contractor. Chilled water valve must be two-way only.

VARIABLE AIR VOLUME BOXES (PHASE II ONLY)

1. All new VAV boxes shall be Titus brand.
2. No fan powered VAV boxes or electric duct heaters allowed.
3. All new VAV boxes must be installed and ducted back to the Landlord's main trunkline by the Landlord's required mechanical contractor, at the Tenant's expense.
4. The maximum pressure drop after the VAV box shall not exceed .25"
5. Duct penetrations at the Landlord's main trunkline must not exceed the size of the inlet at the VAV box by more than one nominal size.
6. Maintain at least 3 duct diameters of straight ductwork prior to the inlet of the VAV box.

> HVAC DESIGN CRITERIA

EQUIPMENT CONTROLS:

1. All HVAC energy management controls shall be purchased through and installed by Landlord's required controls contractor at Tenant's expense. Tenant shall contract directly with Landlord's required controls contractor to install a fully functional direct digital control (DDC) system that must be interfaced into the Landlord's building automation system (BAS). These controls shall provide the following data at a minimum:
 - a. Space Temperature
 - b. Supply Air Temperature
 - c. Return Air Temperature
 - d. Fan Status (Binary Current Transducer)
 - e. Chilled water Valve Position
 - f. Fan Start/StopTenant shall purchase a new chilled water valve from Landlord's control contractor at Tenant's expense. Automated chilled water valves are to be installed by Tenant's mechanical contractor and wired by Landlord's control contractor at Tenant's expense. Tenant is not allowed access to the Landlord's BAS. If a Tenant desires to monitor space conditions, then Tenant is allowed to install, at their expense a stand alone BAS to monitor conditions within their space if desired. Any stand alone monitoring system shall not be attached to the Landlord's BAS in any way.
2. Tenant shall contract directly with the Landlord's required controls contractor to remove all DDC components and disconnect all network cabling before demolition.
3. Tenant's General Contractor shall be held responsible to maintain the integrity of the BAS network cable within their space during all phases of construction. General Contractor shall bear sole responsibility for any damage or disruption to the BAS network.
4. All new tenant HVAC and lighting controls must meet the following specifications:
 - a. Open protocol, BACnet, based communications backbone.
 - b. New controllers must be natively tied into existing Tridium Niagara based BMCS.
 - c. Macerich preferred controllers are BACnet Testing Laboratories (BTL) approved and meet all requirements for BACnet advanced application controllers (B-AAC).

GENERAL MECHANICAL NOTES:

1. A return air grille must be located over each thermostat in the appropriate zone. Landlord must approve final thermostat location.
2. Access panels must be provided for all landlord serviceable equipment which is located above any hard ceiling areas. Supply diffusers and return grilles may be used as an access point, but a working platform must be constructed to the point of the landlord maintained equipment.
3. A Water and Air balance report must be performed by an AABC certified water and air balance contractor at the Tenant's expense. All fan coil units used to condition the space, must have the gpm and all associated temperatures and pressures recorded. The test & balance company must contact the mall HVAC department at 480-990-7502, to insure the units are in full cooling at the time of the test. A copy of the report must be submitted to the landlord upon completion.
4. Fiberglass duct board is not allowed anywhere on the facility.
5. Flexible ductwork must not exceed 6feet in length.
6. Restroom exhaust fans must be motorized with an automatic backdraft damper, and be tied to the light switch. Connect the exhaust discharge to the Landlord's common exhaust trunkline.
7. Zone dampers are not allowed to be installed with fan coil units.
8. Service corridors behind Tenant spaces are not conditioned for temperature.

RESTAURANT EXHAUST REQUIREMENTS:

1. Restaurant exhaust hoods must have a grease filter system with efficiency of no less than 98%. Cut sheets & details for grease filters must be submitted to the landlord.
2. Discharge of all exhaust fans must be kept at a minimum of 20 feet from all mall air intakes.
3. Rooftop mounted grease exhaust fans must be located over a spill containment device in order to protect the roof surface.
4. If existing grease exhaust ductwork is to be reused, then it must be thoroughly cleaned at the Tenant's expense, with a report submitted to the Landlord upon completion.
5. All new rooftop exhaust fans must be Supreme brand, GBD Heavy-Duty, Curb-Mounted units purchased and installed at the Tenant's expense.

> HVAC DESIGN CRITERIA

ODOR CONTROL EXHAUST REQUIREMENTS:

1. All hair salons, nail salons and pet stores must meet the special exhaust criteria. This involves the installation of a separate exhaust system which will generate a negative pressure within the leased premises as outlined below:
2. A total negative pressure of between five and ten percent, (5-10%), minimum, must be maintained during all hours that the Tenant is operating its business in the leased premises.
3. The HVAC system must be modified to provide additional make-up supply air to offset the quantity of air exhausted.
4. A commercial roof-mounted exhaust fan must be used. All new rooftop exhaust fans must be Supreme brand, GBD series units.
5. Air filtration systems are not an acceptable solution.
6. The exhaust fan must be ducted to ceiling grilles located approximately in the center and rear of the leased premises. The system shall be designed to cause the exhaust air to gravitate from the mall common area to the odor producing area and then to the exhaust.
7. The exhaust fan must be interlocked with the light switches for the store customer service area.
8. The Tenant must have an AABC certified water and air balancing contractor test the completed system and verify its operation according to these specifications. A copy of the water and air balance report must be submitted to the landlord for review and approval.
9. Discharge of all exhaust fans must be kept at a minimum of 20 feet from all mall air intakes.
10. The combined HVAC and exhaust system per the above-noted specifications must be in operation during all hours that the Tenant is operating its business in the leased premises.

EXTERIOR MECHANICAL EQUIPMENT SCREENING

1. Screening materials and methods are not meant to be all-inclusive. There may be other tenant proposed options to utilize screening devices not included in this manual. Screening methods are subject to Landlord approval.
2. Alternate screening devices and methods may be acceptable provided they effectively reduce the visual impact of the utility equipment in maintain required clearances. All screening shall be commercial grade, with durable finish.
3. Screening shall not interfere with or adversely affect the operation of the equipment or its access. Materials/design cannot obstruct the cooling of equipment, or restrict opening of access doors or pull boxes.
4. Screening shall be properly supported and compatible with existing roofing systems; and will require Landlord approval to ensure safety, access, and aesthetic considerations of the roofing systems are addressed.
5. All screening systems must comply with local code regulations; stamped structural drawings/ corresponding calculations and/or inspection may be required for large system designs and their attachments methods.
6. Screening systems shall be five (5) sided, panels at all sides and top panel; unless otherwise approved by Landlord. Screening required must be 360 degrees around all roof top equipment and is additive to any screening afforded by the surrounding roof parapet(s). See pictures for reference.
7. Screening materials and colors shall be appropriate and correspond to the surrounding climate and architectural features, and are subject to Landlord approval.

SMOKE EVACUATION SYSTEMS NOTICE

1. Tenant required smoke evac systems are no long applicable at Scottsdale Fashion Square.
2. To perform the following decommission of the existing system, the following conditions must be represented in the space and on the plans:
3. All demising walls must be brought to the deck, eliminating plenum condition and fire dampers.
4. Demising walls must be 1 hour rated and all penetrations fire caulked.
5. The letter on the following page is required to be inserted into all tenant mechanical plans.
6. Coordinate with landlord operations team to remove decommissioned equipment from ceiling area during demolition.

> STRUCTURAL

DESIGN REQUIREMENTS

- **SELF SUPPORTED STOREFRONTS** are required. Tenant may not support the storefront from the bulkhead, fascia, or roof deck. Structural lateral bracing support for Tenant storefronts must be from the roof joists.
- **ROOF DECK ATTACHMENT OR USE AS SUPPORT** for fixtures and equipment is not permitted.
- **HEAVY ITEMS** require structural drawings if weighing 300 lbs. or more.
- **JOIST REINFORCING** is required for roof top equipment as well as steel support for all roof openings.

The documents to be submitted for Landlord approval must include the following:

Complete plans and specifications for all structural work. Documents must be signed and sealed by a Licensed Engineer in the state where the Shopping Center is located.

GENERAL REQUIREMENTS

The Tenant's storefront must be structurally self-supported. Tenant may not support the storefront from the bulkhead or fascia. Structural support for Tenant storefronts must be from the roof joists for lateral bracing.

Fixtures and equipment may not be attached to or supported from the floor or roof deck.

Structural drawings are required for all items that require support from the steel structure or for all roof top equipment weighing 300 lbs. or more. Drawings must be submitted to Landlords Structural Engineer for review and final approval.

Joist reinforcing is required for roof top equipment as well as steel support for all roof openings.

Upper level Tenant's must review base building structural drawings prior to installing a security safe, ovens or any equipment weighing 300 lbs. or more and must obtain Landlord's Structural Engineer's approval at Tenant's cost.

Nothing is permitted to be attached to, suspended from, or penetrates the roof deck above. You are required to frame, brace and / or suspend, as needed, to / from the top chord of joist or structural steel which exist above your respective tenant space.

EXIT CORRIDORS

Distribution of utilities through a newly constructed or an altered exit passageway is prohibited except for equipment and ductwork specifically serving the exit passageway, sprinkler piping, standpipes, electrical raceway for fire department communication and electrical raceway serving the exit passageway.

FOOD CRITERIA CONTENT OVERVIEW

2.1

FOOD COURT

DETAILS SPECIFIC DESIGN, SIGNAGE, AND TECHNICAL REQUIREMENTS FOR FOOD COURT TENANTS.

2.2

INLINE COUNTER SERVICE

DETAILS SPECIFIC DESIGN, SIGNAGE, AND TECHNICAL REQUIREMENTS FOR FOOD TENANTS WITH COMMON AREA FACING COUNTER SERVICE AND LIMITED OR NO SEATING.

2.3

RESTAURANTS

DETAILS SPECIFIC DESIGN, SIGNAGE, AND TECHNICAL REQUIREMENTS FOR FOOD TENANTS WITH INTERIOR OR EXTERIOR FACING RESTAURANT SERVICE.

SECTIONS OF INTEREST

- INLINE CRITERIA**
Standard design, technical, and sign requirements in addition to the contents in this section.
- DESIGN INSPIRATION**
Provides design inspirations for visual aesthetics.
- BUILDING DETAILS**
Includes property reference photos and specific Storefront design details.
- PROPERTY INFO**
Includes information on the Property's building codes, area permitting, and required contractors.
- SUBMITTALS**
Outlines requirements on how and what to compile for submittals to the Landlord for design reviews.

This Food Tenant Criteria is specifically tailored to highlight unique technical and design requirements for Tenant's cooking, preparing, and selling food products.

Through the application of the Criteria guidelines, Food Tenants will produce distinctly original designs unique to their brand and the Center. These guidelines are to help maintain a consistent design quality while still allowing each Tenant to achieve a high level of expression and diversity.

The goal is to enhance the shopping experience for our Customer through the quality and artfulness of Tenant design.

This Criteria will often point to the [INLINE RETAIL CRITERIA](#), as several requirements and design concepts are shared.

The Tenant's Architect is encouraged to contact the Landlord's Tenant Coordinator to discuss any specific design intentions prior to commencing design work. The Tenant Coordinator will strive to resolve all outstanding design issues. However, the Tenant Coordinator may, in the best interest of the Center, reject any aspect of the Tenant's design.

If an acceptable design cannot be agreed upon, the Landlord may, at the Tenant's expense, provide an additional concept Storefront design for consideration.



FOOD COURT > CONTENTS

FOOD COURT ZONE PLAN

DESIGN

STOREFRONT

FOOD DISPLAY & PREP / SEATING / QUEUING

LAYOUT / SERVICE COUNTER DESIGN

STOREFRONT & COUNTER MATERIALS / COUNTER ELEMENTS

LIGHTING

STOREFRONT CEILING / ROLLING GRILLE / NEUTRAL PIERS & DEMISING WALLS

INTERIOR & PREP AREAS

SIGNAGE

STOREFRONT

MENU BOARD

TECHNICAL

SECTIONS OF INTEREST

DESIGN INSPIRATION

Provides design inspirations for visual aesthetics.

PROPERTY INFO

Includes information on the Property's building codes, area permitting, and required contractors.

SUBMITTALS

Outlines requirements on how and what to compile for submittals to the Landlord for design reviews.

The Food Court Criteria provides key technical information and design requirements to ensure your food service enlivens the consumer experience and interfaces with the Center's food court design.

The Tenant and the Tenant's architect assume the following important obligations:

- Fulfill the intent of the Criteria both in concept and in detail.
- Determine and respond to the actual physical conditions of the Tenant's location.
- Maintain and enhance the high standards of quality established in the construction of the Center.
- Ensure the quality of execution of all design material, finish, and detail concepts in the construction of the Tenant's improvement.
- Provide the required detail at all transitions from Tenant Storefront to neighboring Storefronts, as well as to the base building.



> DESIGN > STOREFRONT

OVERVIEW

Food Courts may include a variety of spaces that are comfortable and stylish, inviting the Customer to come, stay, eat, and enjoy.

The design of each unit, as viewed from the common area, must convey the unique character and sense of identity for each Tenant and also be compatible with the overall Architectural design of the Food Court.

The Storefront design area considers all portions of the Store that are visible to the public, in front of the full height service area partition.

Unique and unexpected storefront design will spark interest to draw in Customers.

Encouraged Storefront design traits include:

- Use of contrast:
 - Mixing modern and traditional design elements.
 - Mixing neutrals with colors.
 - Blending shiny and matte surfaces.
- Combining patterns with solids.
- Embracing unique craft and technology.
- Using special features, tasteful props, and displays.



> FOOD DISPLAY & PREPARATION / SEATING / QUEUING

FOOD DISPLAY

Showcases must reinforce the Tenant's image and be an integral part of the design within the counter.

Glass must be tempered or a safety type. Plexiglas is not permitted.

Showcases shall not exceed 14" above counter and 36" overall width. It shall not be more than 50% of the counter length and located no closer than 48" from the neutral pier.

FOOD PREPARATION AS THEATRE

When food preparation is visible to the public, the area is required to be designed with a sense of theater.

The need for an authentic, shared, and unique experience has grown over time. Unique experiences are the opposite of one-size-fits-all approach of the "chain". Tenants that offer a peek into the making of what they sell help include the Customer and make for an authentic experience.

SEATING

- Tenants shall typically not provide, place, or install any seating, carts, etc. inside or outside the lease premises.
- Select specific areas may include private and bistro style seating. These options are site specific, so discussing early with Leasing and Tenant Coordination is recommended. Design Approval is required for all common area Tenant seating.

QUEUE AREAS

- All food venues must provide a queue layout that allows for the Mall to maintain its code minimum distances for general circulation.
- Stanchions are not allowed. Other indicators for Customer directional flow will be considered.



> LAYOUT / SERVICE COUNTER DESIGN

LAYOUT

Due to the high visibility of the Customer Service Area, particular attention is given to the design review of this area. Service areas, furnishings, display cookery, food prep and cooking areas visible from the Mall common area must meet strict design standards.

- Support rooms and storage shall be concealed from public view.
- A full-height partition wall must separate the Customer Service Area and Prep Area.
- Access to the Prep Area shall be via a self-closing door or between staggered “blind walls”.
- Pass-thru windows with any Customer views into kitchen zone are not allowed.
- Landlord may require that any Storefront setback area shall have flooring compatible in quality, color and pattern to the Mall flooring material.
- All Tenant construction shall be self-supporting from the floor and structurally independent of the Mall fascia and bulkhead structure. Tenant construction may be braced horizontally/laterally to the overhead structure (not to the roof deck) within the Tenant space as depicted on Tenant plans and approved by the Landlord.

FRONT SERVICE COUNTER DESIGN

- The vertical counter face cannot be on one plane. Design must include areas that pop in and pop out to create movement. This can be achieved by recessing a small portion of the counter face by a few inches or can be more dramatic. This can also be achieved by ranging counter heights and taller vertical elements. Taller vertical elements must not block visibility.
- Counter face cannot be all one material. Must incorporate a minimum of two to three different types of material that coordinate well together.
- Vertical elements can include a plasma screen menu board or additional vertical signage.
- Tenant to specify a protective edge at the bottom of the counter.
- The form and materials used for counters shall be designed to be inviting to the public to help lure them to the space.
- The toe kick material must be a minimum of 3” behind the face of the counter.
- All Tenant build out must be contained within the lease line unless specifically noted in this Criteria.
- Counter tops must be “Corian” or similar solid surface materials, metal or stone. Tenant counter and counter tops are to be custom designed and fabricated.
- Plastic laminated countertops are prohibited.
- Maximum counter height is 3’-6”. Counter design, including heights, must comply with all accessibility guidelines enforced by national or local jurisdictions and the Americans with Disabilities Act.
- Sneeze guards shall be used above the front counters as required.

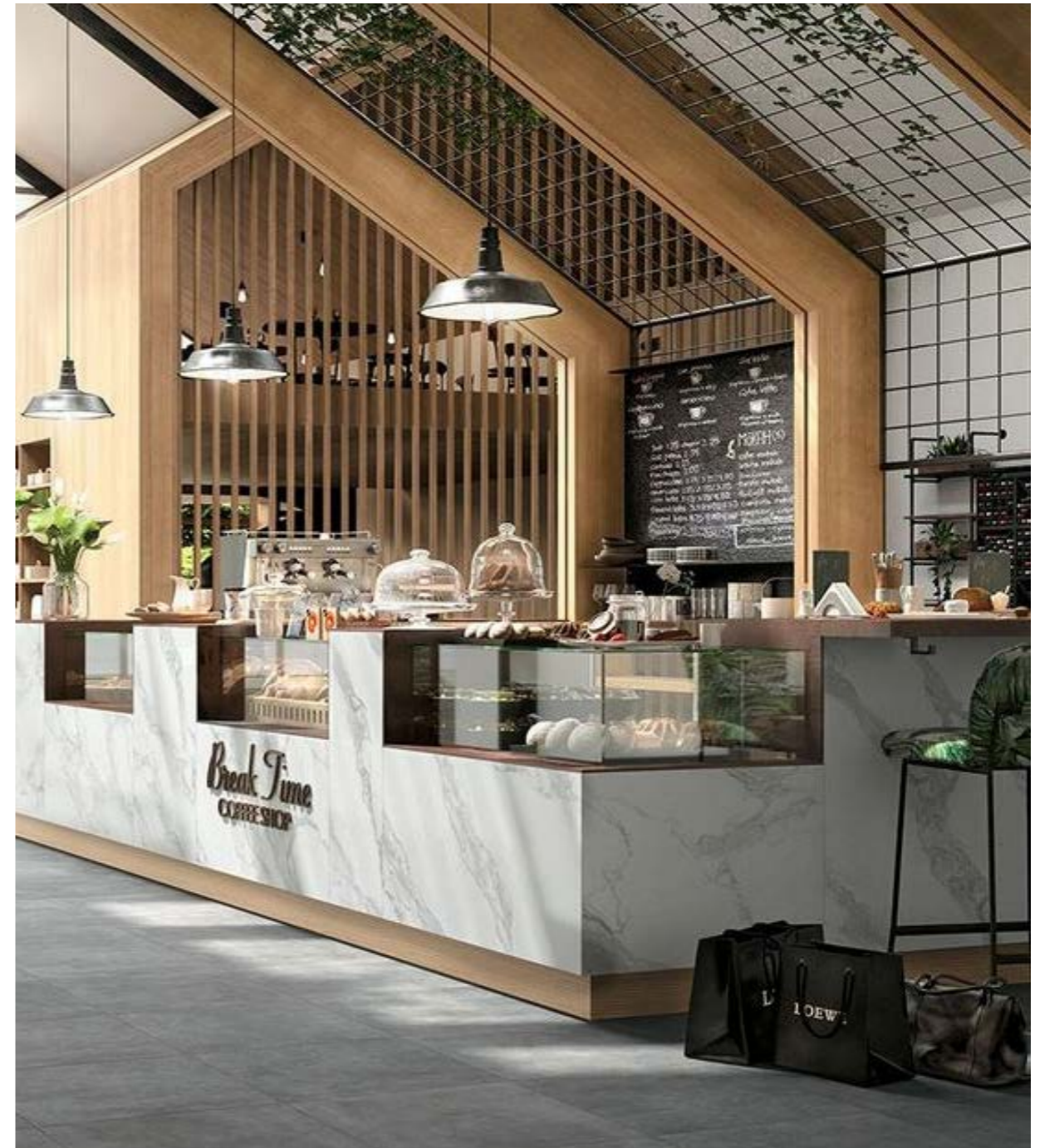

> STOREFRONT & COUNTER MATERIALS / COUNTER ELEMENTS

FRONT SERVICE COUNTER AND STOREFRONT MATERIALS

All finish materials must be backed by a minimum 5/8" solid surface material and may include the following:

- Counter tops must be solid surface materials, metal or stone. Tenant counter and counter tops are to be custom designed and fabricated.
- All stone/tile colors must be integral throughout.
- Metal panels and architectural hardware shall have a professional and durable finish.
- Color anodized, baked painted or antique finish
- Wood veneers and weathered or distressed wood (submit specification for approval)
- Resin panels such as 3-Form products
- Back-painted tempered glass panels
- Glass tiles

Finish materials shall NOT include the following materials:

- 4"x4", 6"x6", 12"x12" glazed tiles
- Shingles or boards
- Plastic laminate
- Faux or plastic formed brick, block or stone
- Clear anodized aluminum
- Other materials as deemed unacceptable by Landlord

COUNTERTOP ELEMENTS

- Cash registers must be recessed so that they extend no more than 9" above the counter top.
- Condiment and utensil displays or dispensers must be fully recessed into the counter.
- Fully recessed counter-top trash receptacles (for straw wrappers, etc.) must be provided near the condiment and utensil displays.
- Tray rails, if used shall be integrated into the counter design and be contained within the lease line.
- Drink dispenser and other utilitarian kitchen equipment may not be placed on the front counter.
- Employee access through the counter front is not permitted. Back counters visible to the public must be built in units with a recessed base detail.



> LIGHTING

LIGHTING

Tenants must light both their Storefront as well as the countertop.

Lighting on architectural elements and menu boards are also required.

- Recessed down lighting must be provided at all gypsum board ceilings visible to customers. BK Lighting MC-48-xxx-9-11-B or approved equal by Lumiere. Lamps are to be 50 PAR 20/H/SP.
- Down lighting or pendant lighting is required at the front counter to provide a more intimate and decorative atmosphere while highlighting the counter top and merchandise presentation. Fixtures to be supplied and installed by Tenant to Landlord specifications. Other track lighting may be considered provided that it is not visible from the public area.
- Fluorescent lights are prohibited in all areas visible to the public. They are however, permitted in areas not visible to the public.



> STOREFRONT CEILING / GRILLE / NEUTRAL PIERS & WALLS

STOREFRONT CEILING

- Suspended ceiling of gypsum board (hard lid) is required in Customer areas. See specific zone area for additional requirements.
- Tenant must provide a reflected ceiling plan indicating any and all Tenant lighting, suspended design elements and signage for Landlord approval.
- Ceiling access panels, where required must be depicted on the Tenant's plans, approved by Landlord and be provided at Tenant's expense.
- Allow for access to all structural mechanical, plumbing, electrical, telephone and fire protection systems including all junction boxes, switches, valves, etc. and other equipment for purposes of servicing, and maintaining this infrastructure.

ROLLING GRILLES

Rolling grilles are not allowed.

NEUTRAL PIERS AND DEMISING WALLS

The Customer Service Area shall address the full opening width, abutting the Neutral Walls and Neutral Knee Walls on each side of the leased space and extending full height to the Mall soffit.

- Mall structural columns, excluding those treated as neutral piers, located either within the Storefront Zone or along the store frontage, must be integrated into the store design unless otherwise directed by Landlord.
- Special condition neutral walls may be low and extend back from the face of the lease line. This condition increases visibility into the store, however, it requires close coordination with the Tenant Coordinator in the design process.



> INTERIOR AND PREP AREA

Kitchen areas, storage, dish areas, and any other areas not visible to the public must meet the following design requirements:

LIGHTING

Lighting may include, but is not limited to:

- 2' x 4' lay-in surface-mounted fluorescent light fixtures.
- Any fixture allowed by code necessary for food preparation.

FLOORING

The entire Lease Premises shall be completely and properly sealed using a 'Dex-o-tex' NEOBOND II Fracture Resistant Membrane Waterproofing or equal membrane type sealer approved by Landlord, prior to the installation of any finished flooring material.

The membrane must be turned up all perimeter Storefront walls, counters and surfaces a minimum of 24", to protect the adjacent Tenants and Mall common areas. Then, either FRP (prep area only), or tile is to be installed up to at least 4'.

Tenant to submit detail to Landlord for approval prior to installation.

Tenant shall furnish and install floor tile over waterproof membrane throughout the entire premises.

The finished floor must be sloped to the Tenant installed floor drains.

Allowed flooring materials include:

- Quarry tile
- Porcelain ceramic tile

Prohibited flooring materials include:

- Vinyl
- Glazed ceramic tile
- Carpet
- Any other material deemed unsuitable by the Landlord

CEILING

2' x 4' drop-in panels with an approved finish shall be permitted in storage areas so long as they are not visible to the customers.

WALLS

All walls in the Prep Area must be of a durable, non-porous, washable surface as required by health codes.

EXIT DOORS

All exit door specifications, hardware, door handles, recess dimensions, etc. shall be per Landlord Criteria and conform to local codes and ordinances.



> SIGNAGE > STOREFRONT

Food Court Tenant's primary Storefront sign must be creative, imaginative and incorporated into the overall Storefront design.

- Sign must be proportional to overall elevation. Landlord will review sign size on an individual basis. Sign length must not be more than 1/3 of the overall storefront length.
- Sign must complement overall design and add visual interest.
- Sign must be mounted on the sign shelf as shown in the [ZONE PLAN](#).
- Power must be concealed.
- 12" max letter height will be enforced.
- Back of sign must be finished.
- Food Court blade signs in current use will be phased out in 2026 along with the planned Palm Court Refresh, and will no longer be approved for addition.



> MENU BOARDS

Menu board applications must be a part of the overall store design. We strongly encourage using a graphic designer to create your boards.

DESIGN REQUIREMENTS

The following requirements must be used when designing your menu boards:

- All menu boards must be submitted to the Landlord for review and approval prior to start of Tenant construction.
- Professional quality drawings/renderings must be submitted for approval.
- Design shall be an integral part of the graphics and complimentary to primary signage character.
- Overall width of menu board cannot exceed 60% of overall Storefront width.
- Mounting height to be a minimum of 7'-0" to bottom of sign with maximum height of 10'-0" and held a minimum of 10" from edge of walls.
- The menu board must be non-reflective to avoid glare.

PERMITTED ELEMENTS

Permitted menu board design elements include:

- Artisan type quality such as chalkboards, painted wood or unusual materials and combinations of material.
- Frames, holders, text, photo displays, lighting and materials must be creatively designed.
- High quality digital printouts for menu board may be approved at Landlord's discretion.
 - Photographs used in menu boards must be professionally produced and approved by the Landlord.
 - Plasma screens cannot be surface mounted.
- Externally illuminated menu boards are allowed.
 - Tenant is required to submit light fixture cut sheet for approval.

PROHIBITED ELEMENTS

Not permitted menu board design elements include:

- Standard factory designs.
- Standard surface-mounted box-type internally illuminated menu boards are not permitted.



> TECHNICAL

Food Court Tenants must adhere to the technical requirements found in the [INLINE TECHNICAL CRITERIA](#).

In addition to the requirements detailed in the Technical Criteria, Tenants cooking food in their space must adhere to the following:

GENERAL REQUIREMENTS

- **KITCHEN SINKS** including pot sinks, scullery sinks, pre-wash sinks and other kitchen units must be connected to a grease trap.
- **DISHWASHERS** may not be connected to grease trap.
- **GREASE INTERCEPTOR** must be designed by Tenant and approved by Landlord prior to installation, especially if located outside the lease line.
- **OIL COLLECTION AND HAULING SYSTEM** is required for Tenants with fryers or other grease/oil generating equipment that does not run through an interceptor. Landlord does not provide a centralized collection point.
- **BACKFLOW PREVENTERS** are required for food service, hair salons or other Tenants with equipment or operations that have the possibility of backflow. These must be certified and acceptable to the water district and checked yearly or as required by the local authority having jurisdiction.

KITCHEN EXHAUST REQUIREMENTS

- **LANDLORD REVIEW** is required to ensure the exhaust does not compromise the ventilation air of adjacent mall roof top units.
- **GREASE EXHAUST** must be provided on all exhaust blowers. Supreme Heavy Duty GBD Exhaust Blowers are required for all kitchen exhaust or grease laden air removal.
- **A GREASE-GUARD** containment system must be used to surround all roof equipment to protect the roof.
- **CLEANING** of grease traps, or interceptors to be performed after Mall closing.

FUMES AND ODORS

The following constitutes the minimum requirements for special exhaust systems which Tenant must furnish and install in the Leased Premises for the elimination of fumes and odors due to Tenant operations:

- A separate exhaust system must be provided and installed which will generate negative pressure in the Leased Premises as outlined below.
- A total negative pressure of between five and ten percent (5-10%) must be maintained during all hours that Tenant is operating its business in the Leased Premises.
- The HVAC system must be modified to provide additional make-up supply air to offset the quantity of air exhausted.
- The Tenant must have an AABC certified air balancing contractor test the completed system and verify its operation according to these specifications. A copy of the air balancing report must be submitted to the Mall General Manager for review and approval prior to opening for business.
- The combined HVAC and exhaust system per the above-noted specifications must be in operation during all hours that Tenant is operating its business in the Leased Premises.
- The combined HVAC system must be connected to the Landlord EMS by the Landlord required contractor. See the Technical Criteria section for specifics.
- Indoor tenants which will be using any type of gas, liquid or solid fuel for heating, cooking or other use, must have an active carbon monoxide detector installed. The type should be and Hardwire Interconnectable 120- Volt Carbon Monoxide Alarm with Digital Display and Battery Backup.
- Carbon dioxide detection is required if tenant has a carbon dioxide systems with 100 lbs. or more of carbon dioxide used in their beverage dispensing applications.

STRUCTURAL

The structure or sub-structure that supports any new or replacement HVAC unit, transformer, other heavy equipment or modification of any structure or substructure, shall be designed, engineered and installed at Tenant's sole cost and expense.

Tenant shall provide structural engineering calculations and drawings from a licensed structural engineer (Registered in the State of the Center where the work is located) to Landlord for review and approval prior to installation of any such items or equipment.

All equipment is to be installed over structural members that can support the weight of the equipment in areas designated by Landlord.

All recommendations of design and verification of completion shall include the structural engineer's embossed seal from the state.

Natural Gas service is available for Tenants to obtain. Tenants will be responsible for obtaining gas service from the gas company. Gas is permitted for cooking equipment only, not for HVAC.

POTABLE WATER

A single water stub-in will be supplied by the Landlord from the Landlord's meter to each Tenant space. Tenant shall provide a water sub-meter that is accessible to Mall management.

SANITARY WASTE

A 4" sanitary waste line shall be stubbed below each Tenant space by Landlord. Tenant shall route their own vent lines to a point above the roof.

GREASE WASTE

Tenant shall route their own vent lines to a point above the roof. Tenant must provide their own grease interceptors / traps.

FIRE PROTECTION / SPRINKLER SYSTEM

Tenants must use the Mall's required sprinkler contractor as well as connect to the Landlord's fire alarm system, using the Landlord required fire alarm contractor.

INLINE COUNTER SERVICE > CONTENTS

❑ DESIGN

- ❑ *PREP & FOOD DISPLAY / LAYOUT*
- ❑ *QUEUE / PATIOS / SEATING*
- ❑ *COUNTER DESIGN / COUNTER ELEMENTS*
- ❑ *MATERIALS / LIGHTING / FLOORING*

❑ SIGNAGE

- ❑ *PRIMARY SIGNAGE / MENU BOARDS*

❑ TECHNICAL

SECTIONS OF INTEREST

- ❑ *INLINE CRITERIA*
Includes standard design, technical, and sign requirements in addition to the contents in this section.
- ❑ *DESIGN INSPIRATION*
Provides design inspirations for visual aesthetics.
- ❑ *BUILDING DETAILS*
Includes property reference photos and specific storefront design details.
- ❑ *PROPERTY INFO*
Includes information on the Property's building codes, area permitting, and required contractors.
- ❑ *SUBMITTALS*
Outlines requirements on how and what to compile for submittals to the Landlord for design reviews.

The Inline Food Counter Service Criteria provides key technical information and design requirements to ensure your common area facing counter food service enlivens the consumer experience and interfaces with the Center.

This criteria will often point to the [INLINE RETAIL CRITERIA](#) as several requirements and design concepts are shared. The content in this section highlights the unique concepts for food service design.

The tenant and the tenant's architect assume the following important obligations:

- Fulfill the intent of the Criteria both in concept and in detail.
- Determine and respond to the actual physical conditions of the Tenant's location.
- Maintain and enhance the high standards of quality established in the construction of the Center.
- Ensure the quality of execution of all design material, finish, and detail concepts in the construction of the Tenant's improvement.
- Provide the required detail at all transitions from Tenant storefront to neighboring storefronts, as well as to the base building.



> DESIGN > PREP & FOOD DISPLAY / LAYOUT

Inline and Restaurant Food Tenants must adhere to the design requirements found in the [INLINE RETAIL DESIGN CRITERIA](#).

In addition to the requirements detailed in the Design Criteria, Tenants serving food in their space must adhere to the following design requirements:

PREPARATION AS THEATER

Tenant's offering a peek into the making of food, by nature, include the Customer and make for an authentic experience. This inclusion of the Customer will increase engagement and is highly encouraged.

FOOD DISPLAY

When displaying food, the following requirements must be followed:

- Showcases must reinforce the Tenant's image and be an integral part of the design within the counter.
- Glass must be tempered or a safety type. Plexiglas is not permitted.
- Showcases shall not exceed 14" above counter and 36" overall width. It shall not be more than 50% of the counter length and located no closer than 48" from the neutral pier.

LAYOUT

Due to the high visibility of the Customer Service Area particular attention is given to the design review of this area. Service areas, furnishings, display cookery, food prep and cooking areas visible from the mall common area must meet strict design standards.

- Support rooms and storage shall be concealed from public view.
- A full-height partition wall must separate the Customer Service Area and Prep Area.
- Access to the Prep Area shall be via a self-closing door or between staggered "blind walls".



> DESIGN > QUEUE / PATIOS / SEATING

QUEUE AREAS

All food venues must provide a queue layout that allows for the Mall to maintain its code minimum distances for general circulation.

Stanchions are not allowed. Other indicators for customer directional flow will be considered.

PATIO AREAS

Exposed patios are encouraged however, they should not extend beyond the lease line. In special cases there may be opportunity to extend the patio but it must be in compliance with all common mall code, circulation requirements, and leasing agreements.

Projection or canopy may increase the visibility of the storefront over seating areas. They also help with lighting the Storefront.

- Common mall flooring must be maintained. Coordinate with Landlord design if railings or other elements will have an effect on the flooring.

SEATING

Where interior seating is needed or desired, it is suggested that the enclosure line be moved into the lease space by approximately 12 feet.

- Patio seating must be separated from the common area circulation in the Mall. A layout will be required.
- All visible furniture must be reviewed by the Landlord for suitability both aesthetically, as well as for performance specifications.
- Tenant is responsible to confirm additional requirements with the local authorities for any railing or barrier for the Tenant's proposed area.
- In some cases options for furniture may be supplied by the mall design team for the Tenant to choose from.



> COUNTER DESIGN / COUNTER ELEMENTS

FRONT SERVICE COUNTER DESIGN

- The form and materials used for counters shall be designed to be inviting to the public to help lure them to the space.
- Tenant to specify a protective edge at the bottom of the counter.
- Counter tops must be “Corian” or similar solid surface materials, metal or stone. Tenant counter and counter tops are to be custom designed and fabricated.
- Plastic laminated countertops are prohibited.
- Maximum counter height is 3’-6”. Counter design, including heights, must comply with all accessibility guidelines enforced by national or local jurisdictions and the Americans with Disabilities Act.
- Sneeze guards shall be used above the front counters as required.

COUNTERTOP ELEMENTS

- Cash registers must be recessed so that they extend no more than 9” above the counter top.
- Condiment and utensil displays or dispensers must be fully recessed into the counter.
- Fully recessed counter-top trash receptacles (for straw wrappers, etc.) must be provided near the condiment and utensil displays.
- Drink dispenser and other utilitarian kitchen equipment may not be placed on the front counter.



> MATERIALS / LIGHTING / FLOORING

FRONT SERVICE COUNTER AND STOREFRONT MATERIALS

All finish materials must be backed by a minimum 5/8" solid surface material and may include the following:

- Countertops must be solid surface materials, metal or stone. Tenant counter and counter tops are to be custom designed and fabricated.
- All stone/tile colors must be integral throughout.
- Metal panels and architectural hardware shall have a professional and durable finish.
- Color anodized, baked painted or antique finish
- Wood veneers and weathered or distressed wood (submit specification for approval)
- Resin panels such as 3-Form products
- Back-painted tempered glass panels
- Glass tiles

Finish materials shall NOT include the following materials:

- 4"x4", 6"x6", 12"x12" tiles
- Shingles or boards
- Plastic laminate
- Faux or plastic formed brick, block or stone
- Clear anodized aluminum
- Other materials as deemed unacceptable by Landlord.

LIGHTING

Tenants must light both their Storefront as well as the countertop. Lighting on architectural elements and menu boards are required.

FLOORING

All "wet" areas must install a waterproof membrane that is tested and confirmed by the Landlord. Full requirements can be found in the plumbing section of the [INLINE TECHNICAL CRITERIA](#).



> SIGNAGE > PRIMARY / MENU BOARDS

PRIMARY STOREFRONT SIGN

Inline and Restaurant Food Tenants must adhere to the signage requirements found in the [INLINE SIGN CRITERIA](#).

MENU BOARDS

Inline and Restaurant Food Tenants must adhere to the menu board requirements found in the [FOOD COURT SIGN CRITERIA](#).

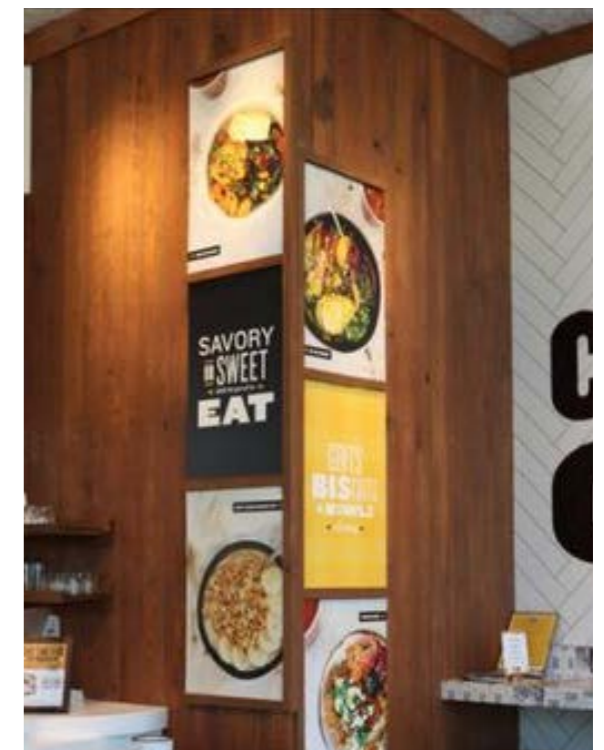

> TECHNICAL

Inline and Restaurant Food Tenants must adhere to the technical requirements found in the [INLINE TECHNICAL CRITERIA](#).

In addition to the requirements detailed in the Technical Criteria, Tenants cooking food in their space must adhere to the following:

GENERAL REQUIREMENTS

KITCHEN SINKS including pot sinks, scullery sinks, pre-wash sinks and other kitchen units must be connected to a grease trap.

DISHWASHERS may not be connected to grease trap.

GREASE INTERCEPTOR must be designed and approved by Landlord prior to installation, especially if located outside the lease line.

OIL COLLECTION AND HAULING SYSTEM is required for Tenants with fryers or other grease/oil generating equipment that does not run through an interceptor. Landlord does not provide a centralized collection point.

BACKFLOW PREVENTERS are required for food service, hair salons or other Tenants with equipment or operations that have the possibility of backflow. These must be certified and acceptable to the water district and checked yearly or as required by the local authority having jurisdiction.

KITCHEN EXHAUST REQUIREMENTS

LANDLORD REVIEW is required to ensure the exhaust does not compromise the ventilation air of adjacent mall roof top units.

EXHAUST FAN must be a SWSI centrifugal fan which must be fitted with a minimum 10'-0" stainless steel upblast. Guy wires must be attached to the roof in order to secure the stack. Use the mall roofer for connection of the guy wires at Tenant's expense.

GREASE GUARD CONTAINMENT SYSTEM (or approved equal) must be installed to protect the Landlord's roof. A quarterly maintenance program must be in-place for the grease containment units. Proof of the maintenance contract must be presented to Operations Manager prior to the store opening.

RESTAURANT SPECIFIC REQUIREMENTS

PLANS MUST SHOW sizes and locations for all duct and piping through roof as well as all required fireproofing.

CONTAIN ALL GARBAGE AND REFUSE AREAS WASH DOWN "grey" water and properly drain off into city approved system (i.e. sewer or storm).

FOOD PREP AND BAKING ON SITE REQUIREMENTS

INSTALL DRY CHEMICAL EXTINGUISHING DEVICES (such as Ansul) approved by the fire insurance rating organization carriers.

MAINTAIN ALL EXHAUST DUCTS AND FILTERS in a clean condition. Ducts are to be professionally cleaned on a regular basis to help prevent grease fires.

GARBAGE AND REFUSE MUST BE PLACED IN CONTAINERS which shall be kept, until collected, in a self-contained area within the demised premises set aside for the storage of garbage and/or storing of inflammable or combustible materials. Tenant agrees to install and maintain appropriate chemical extinguishing devices.

FAILURE TO INSTALL REQUIRED EQUIPMENT referred to in this section and/or to subscribe to the servicing thereof, Landlord shall have the right to enter the demised premises and to make any necessary installations and charge the cost of such installations and/or the servicing thereof to Tenant which Tenant agrees to pay to Landlord, as additional rent, within ten (10) days after demand.

TENANT IS RESPONSIBLE for the removal of all trash from their premises to the Landlord supplied trash receptacles or compactors.

GAS UTILITY

Gas may be available at the Center for cooking applications. If available, Tenant, at its sole cost and expense and in compliance with local code must procure gas service to and within the demised premises and will make all necessary arrangements with the local Gas Company for such service.

SERVICE REQUIREMENTS

GAS METER INSTALLATION at gas meter header is the responsibility of the Tenant.

GAS PIPING INSTALLATION, when allowed, is the responsibility of the Tenant to provide and install. Roof piping must be placed on pillow blocks or similar arrangement. All roof repairs to be by the Landlord's required roofer at Tenant's expense.

PRESSURE REGULATORS required for connection to Tenant's equipment is the responsibility of the Tenant. Coordinate with Landlord for regulator vent routing.

RESTAURANTS > CONTENTS

❑ DESIGN

❑ *STOREFRONT / PREPARATION AS THEATER*

❑ *CONTROL AREAS / SEATING*

❑ *EXTERIOR*

❑ SIGNAGE

❑ *STOREFRONT / MENU BOARDS*

❑ TECHNICAL

SECTIONS OF INTEREST

❑ *INLINE CRITERIA*

Includes standard design, technical, and sign requirements in addition to the contents in this section.

❑ *DESIGN INSPIRATION*

Provides design inspirations for visual aesthetics.

❑ *BUILDING DETAILS*

Includes Property reference photos and specific Storefront design details.

❑ *PROPERTY INFO*

Includes information on the Property's building codes, area permitting, and required contractors.

❑ *SUBMITTALS*

Outlines requirements on how and what to compile for submittals to the Landlord for design reviews.

The Restaurant Criteria provides key technical information and design requirements to ensure your interior or exterior facing restaurant food service enlivens the consumer experience and interfaces with the Center.

This Criteria will often point to the [INLINE RETAIL CRITERIA](#) as several requirements and design concepts are shared. The content in this section highlights the unique concepts for food service design.

The Tenant and the Tenant's architect assume the following important obligations:

- Fulfill the intent of the Criteria both in concept and in detail.
- Determine and respond to the actual physical conditions of the Tenant's location.
- Maintain and enhance the high standards of quality established in the construction of the Center.
- Ensure the quality of execution of all design material, finish, and detail concepts in the construction of the Tenant's improvement.
- Provide the required detail at all transitions from Tenant Storefront to neighboring Storefronts, as well as to the base building.



> DESIGN > STOREFRONT / PREPARATION AS THEATER

Restaurant Food Tenants must adhere to the design requirements found in the [INLINE DESIGN CRITERIA](#).

In addition, Tenants serving food in their space must also adhere to the following:

GENERAL STOREFRONT AND DESIGN

We encourage a cohesive presentation of the brand within the context of the whole Mall design, while the individual brand is important and the two must harmonize. Design should be tailored to its location both within the community and the whole Center's aesthetics.

Restaurants may face both the interior and the exterior, and are often located adjacent to a Mall entry. The exterior and the interior are subject to different Criteria standards, both for presentation and signage.

Interior restaurants oftentimes have a waiting area within the common space.

- If needed these must be shown in the submissions and be approved by Landlord. They must be coordinated with common area needs and code requirements.

PREPARATION AS THEATER

Tenant's offering a peek into the making of food, by nature, include the Customer and make for an authentic experience. This inclusion of the Customer will increase engagement and is highly encouraged.



> CONTROL AREAS / SEATING

CONTROL AREAS

The DCA is the area at the front of the Tenant space that extends from the lease line to all points 6'-0" into the space. It should convey excitement and give the consumer a reason to engage.

Exposed patios are encouraged however, they should not extend beyond the lease line. In special cases there may be opportunity to extend the patio but it must be in compliance with all common Mall code and circulation requirements.

Projection or canopies may increase the visibility of the Storefront over seating areas. They also help with lighting the Storefront.

In addition to the general DCA Criteria for inline stores the following requirements must be met:

- All patio rails, reception podiums, waiting areas, menu presentations, lighting, heating, visible banquet detailing, and material palates must be presented for review and approval.
- Common Mall flooring must be maintained. Coordinate with Landlord design if railings or other elements will have an effect on the flooring.

SEATING

Where interior seating is needed or desired, it is suggested that the enclosure line be moved into the lease space by approximately twelve (12') feet.

Seating design requirements include:

- Patio seating must be separated from the common area circulation in the Mall by a low barrier. A layout will be required for review.
- All visible furniture must be reviewed by the Landlord for suitability both aesthetically, as well as for performance specifications.
- Tenant is responsible to confirm additional requirements with the local authorities for any railing or barrier for the Tenant's proposed area.



> EXTERIOR

Restaurants with exterior Storefronts will be subject to the general Criteria in this manual, for aesthetics.

Exterior design should be tailored to its location both within the community as well as the whole Mall and its aesthetics.

SITE PLANS

- A Site Plan must be submitted that includes all required calculations for GLA, GBA, and parking requirements.
- Site Circulation must be included showing the adjacent intersections, driveways, drive directions, and dimensions of all access points.
- Photos of adjacent and onsite conditions may be required by Ownership for the review process.

AMENITIES

- Planters, heat lamps, tables, chairs etc., must be submitted for approval. All amenities must be commercial grade and suitable for outdoor use.
- Pendant or sconce lighting must be submitted for approval by Landlord.
 - Lighting plans of canopies and trellis are available in Landlord supplied base drawings.
- Umbrellas are only allowed in the designated areas and cannot overhang into the public right-of-way.
 - Umbrellas should be small in scale (maximum 6'-0" in diameter) and no more than 9'-0" high at the peak.
 - Wood or metal are the only acceptable materials for the umbrella structure. No insignia, graphics or text are permitted on the umbrella fabric.
 - The umbrella fabric must be flame retardant material in a color approved by Landlord's Tenant Coordinator.

EXTERIOR PATIOS

- Any changes to an existing patio must be approved by Landlord. Tenant is responsible to confirm the requirements with the local municipality for proposed use.
- Temporary elements such as greeting stands, or waiting areas must be submitted for review.
- Confirm code height and density of railings for any necessary barriers.
- Patio layouts with adjacent circulation dimensions must be included in the first submittal of documents for design review.
- Railing design details should be submitted with the concept and construction packages for approval by the Landlord design team.



> SIGNAGE > PRIMARY / MENU BOARDS

PRIMARY STOREFRONT SIGN

Inline and Restaurant Food Tenants must adhere to the Signage requirements found in the [INLINE SIGN CRITERIA](#).

Exterior signage must adhere to the requirements established by the local municipality.

MENU BOARDS

Inline and Restaurant Food Tenants must adhere to the menu board requirements found in the [FOOD COURT SIGN CRITERIA](#).



> TECHNICAL

Inline and Restaurant Food Tenants must adhere to the technical requirements found in the [INLINE TECHNICAL CRITERIA](#).

In addition to the requirements detailed in the Technical Criteria, Tenants cooking food in their space must adhere to the same requirements found in the [INLINE FOOD TECHNICAL CRITERIA](#).

BUILDING DETAILS CONTENT OVERVIEW

3.1 MALL ZONES

SECTIONS OF INTEREST

- DESIGN INSPIRATION**
Provides visual inspirations for design aesthetics.
- PROPERTY INFO**
Includes information on the Property's building codes, area permitting, and required contractors.
- SUBMITTALS**
Outlines the requirements on how and what to compile for submittals to the Landlord for design reviews.



MALL ZONES > OVERVIEW MAP

This section provides storefront design details and visual references specific to the primary zones located within Scottsdale Fashion Square.

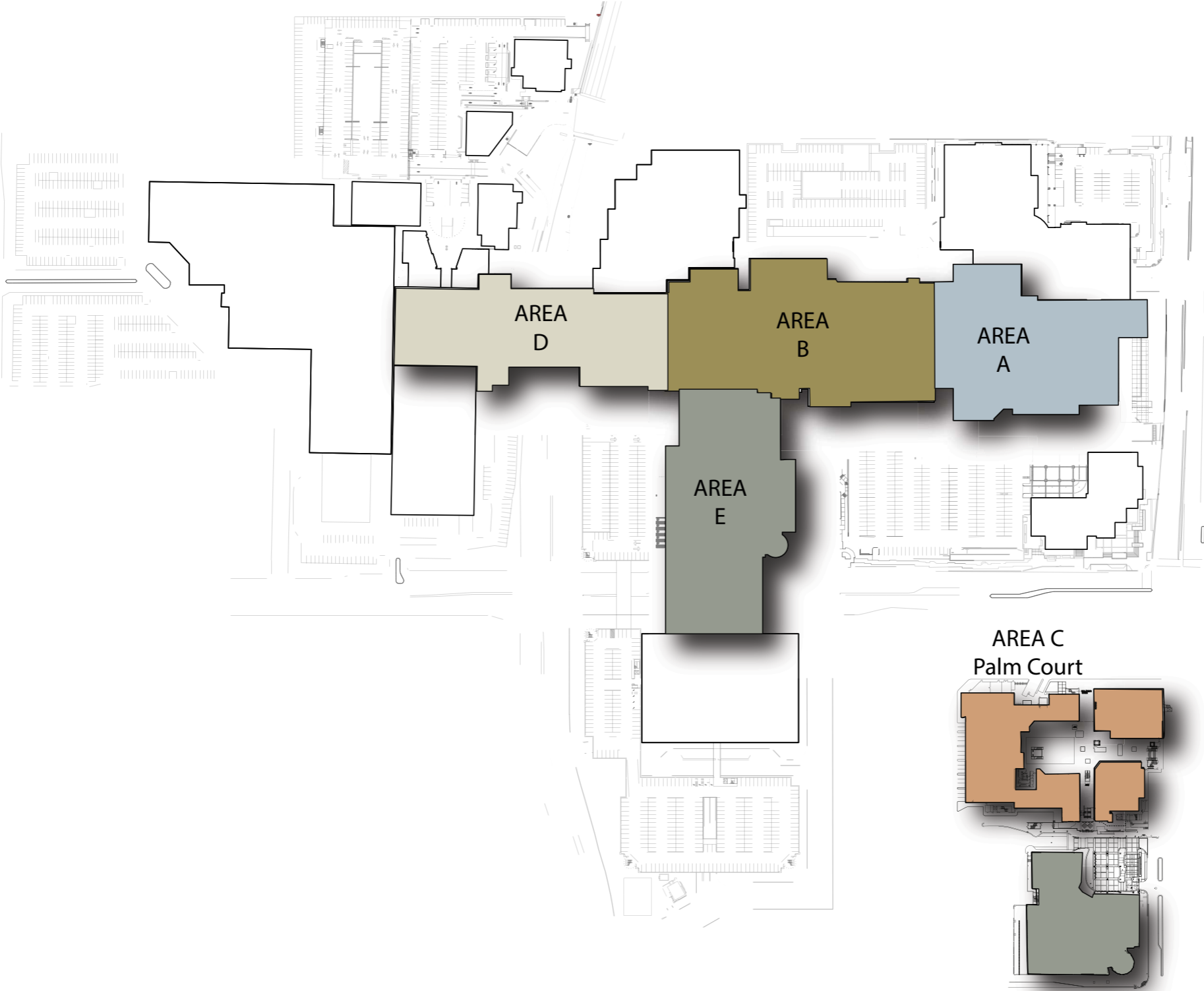

MALL ZONES > STOREFRONT CONDITIONS > AREA A

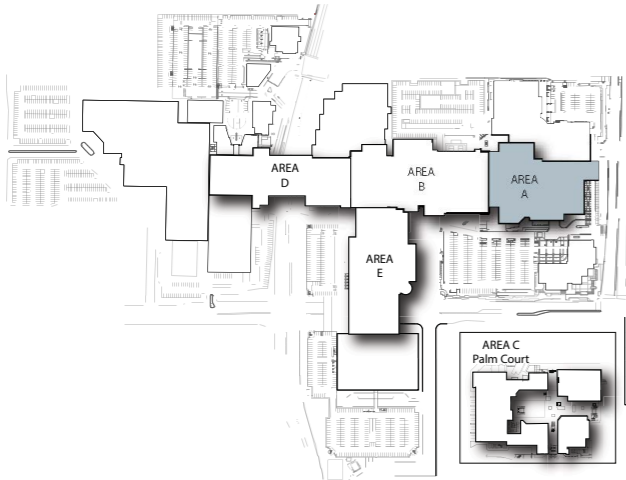

AREA A FIRST LEVEL

STOREFRONT CONDITIONS

- TYPE A** 14'-3" TENANT STOREFRONT TO INCLUDE 4" REVEAL
- TYPE B** 15'-6" TENANT STOREFRONT TO INCLUDE 4" REVEAL
- TYPE C** 12'-11" TENANT STOREFRONT TO INCLUDE 4" REVEAL



MALL ZONES > STOREFRONT CONDITIONS > AREA A

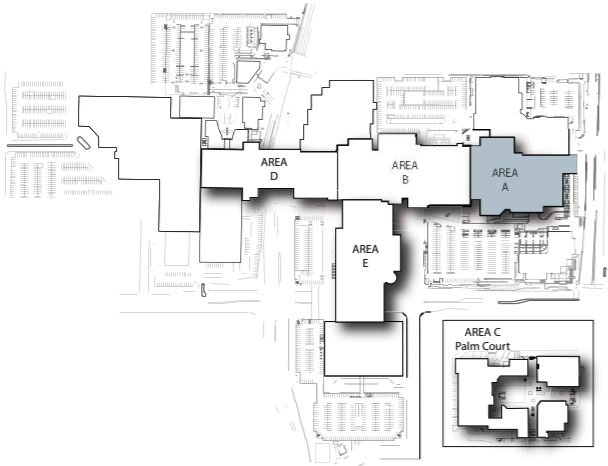

AREA A SECOND LEVEL

STOREFRONT CONDITIONS

- TYPE A 14'-3" TENANT STOREFRONT TO INCLUDE 4" REVEAL
- TYPE B 15'-6" TENANT STOREFRONT TO INCLUDE 4" REVEAL
- TYPE C 12-11" TENANT STOREFRONT TO INCLUDE 4" REVEAL

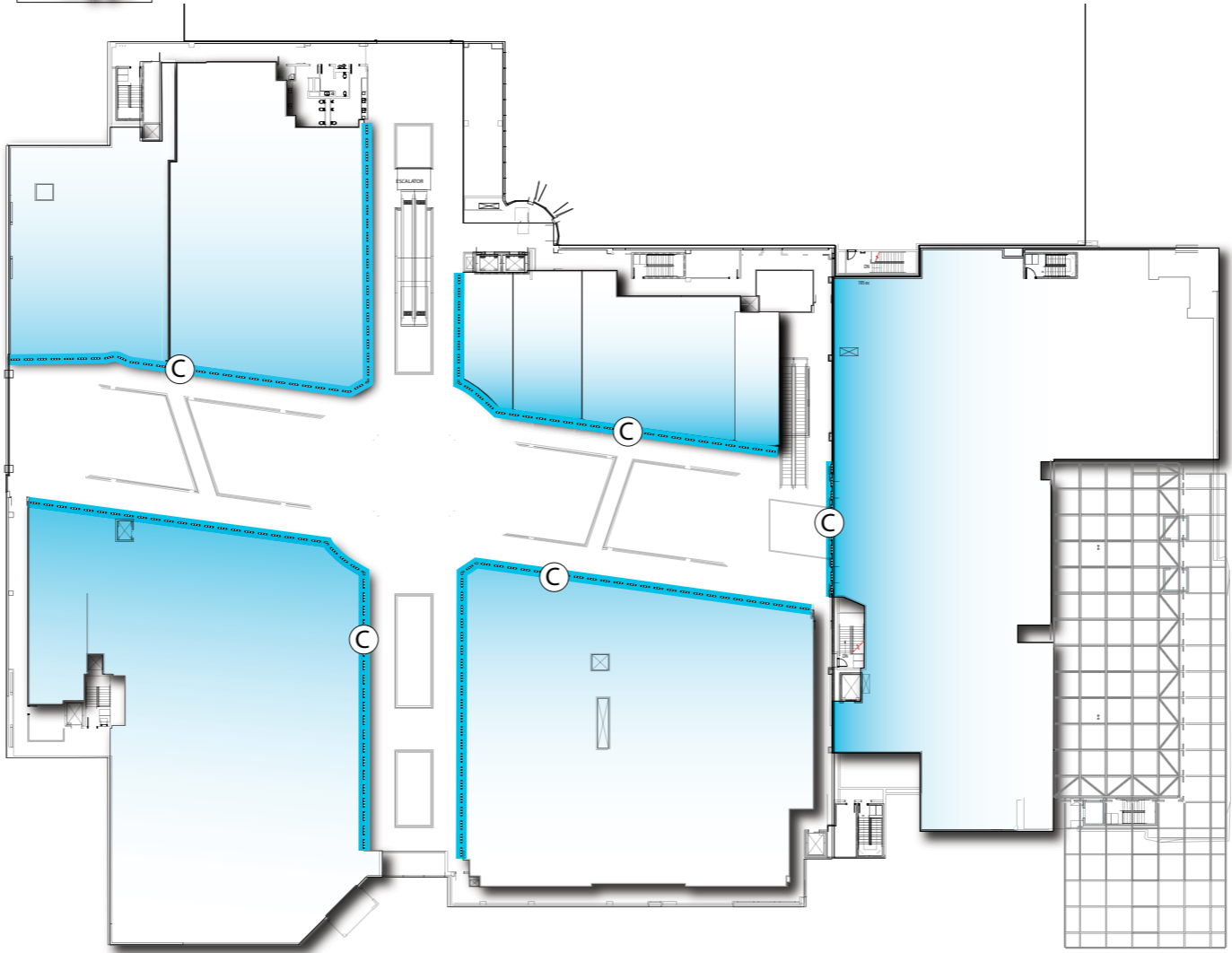

MALL ZONES > STOREFRONT CONDITIONS > AREA A

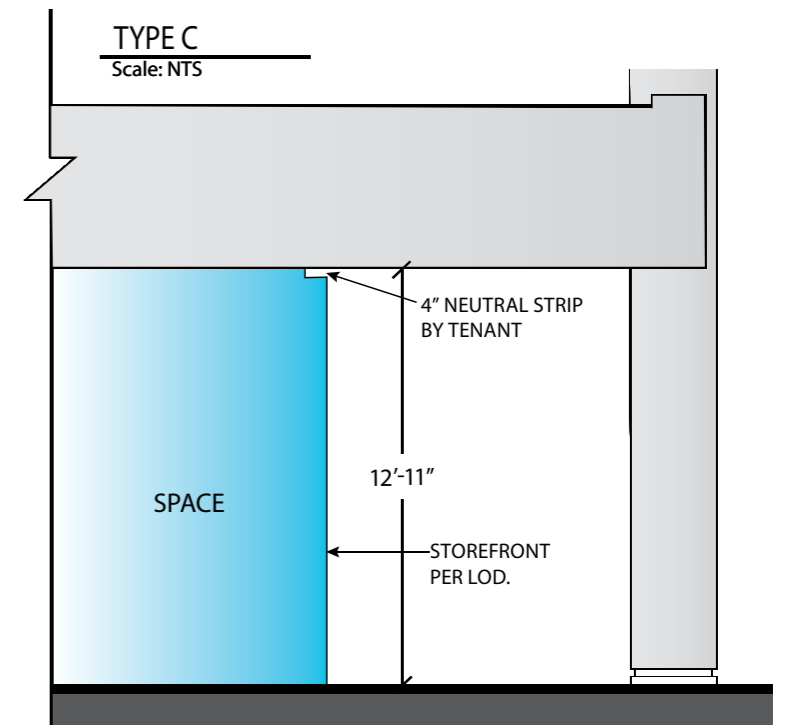
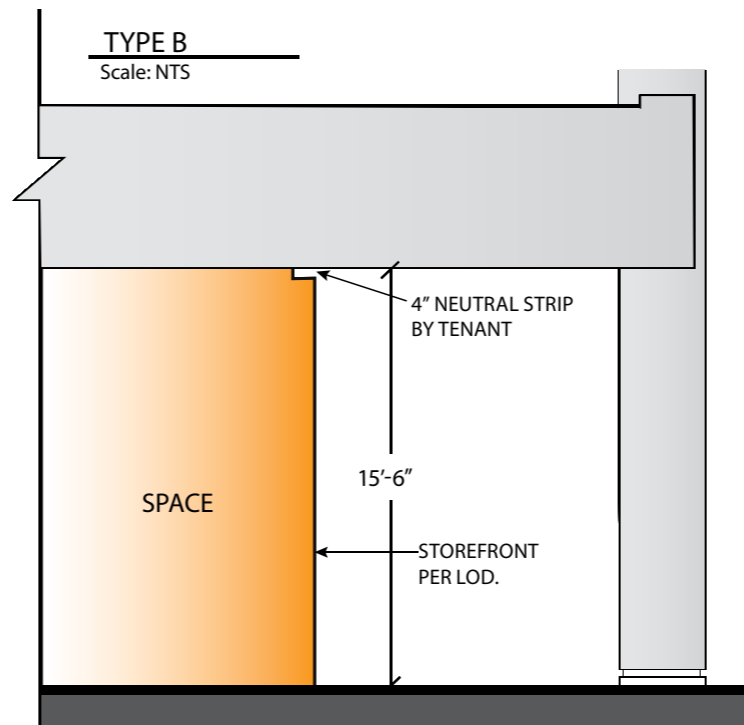
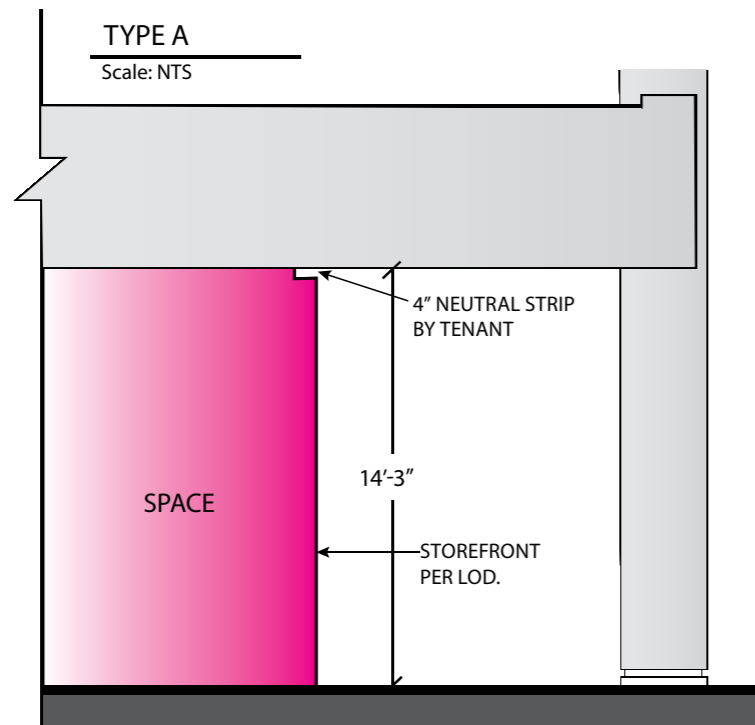
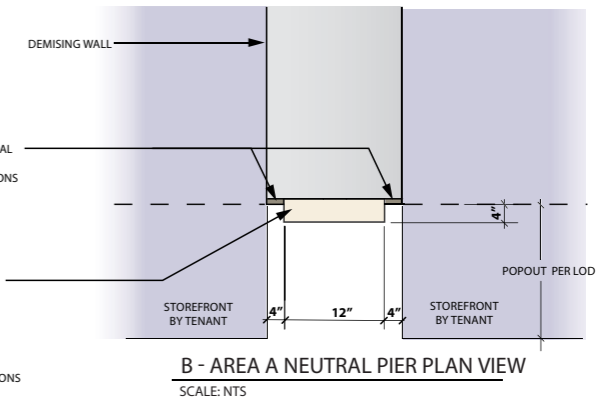
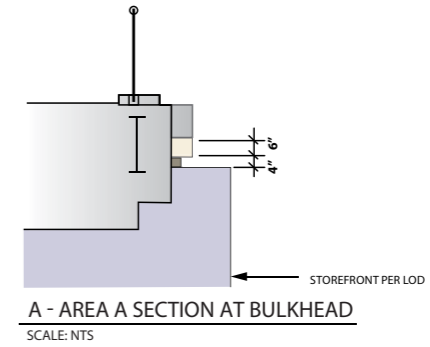
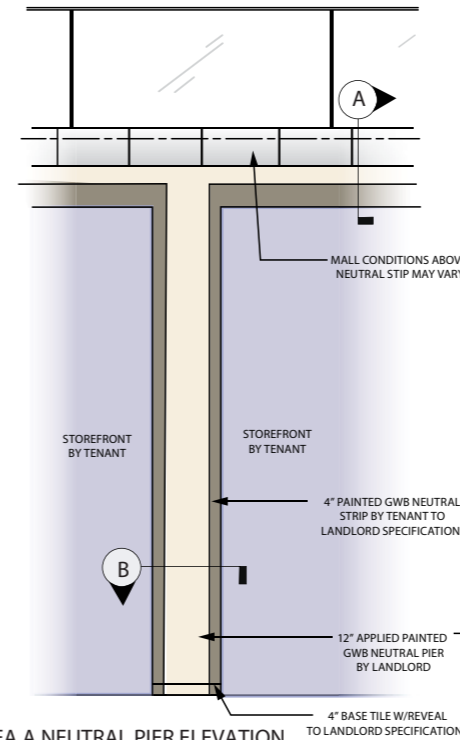
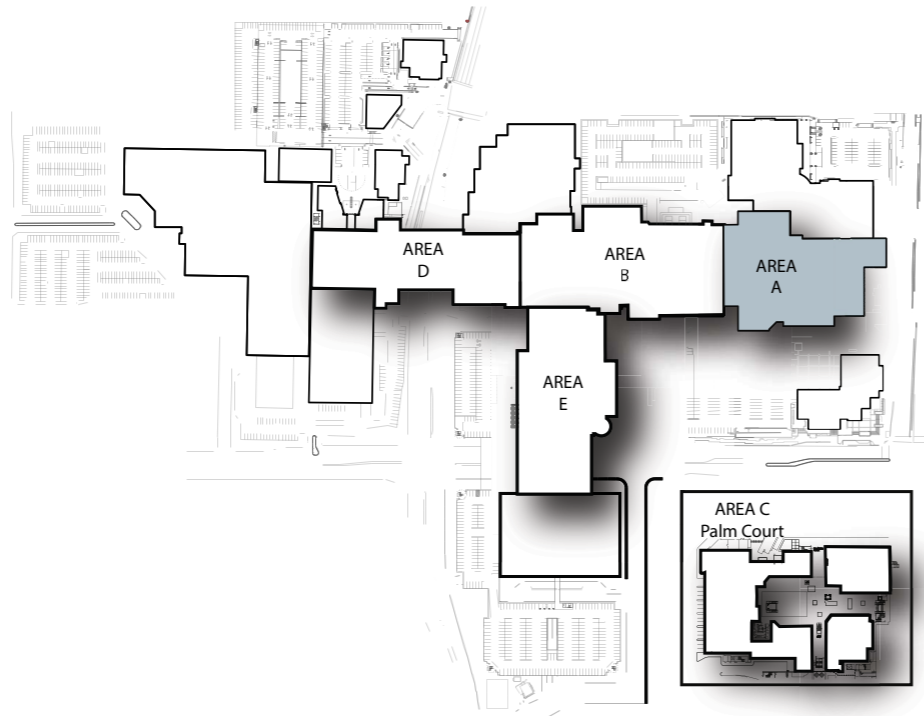

MALL ZONES > STOREFRONT CONDITIONS > AREA B

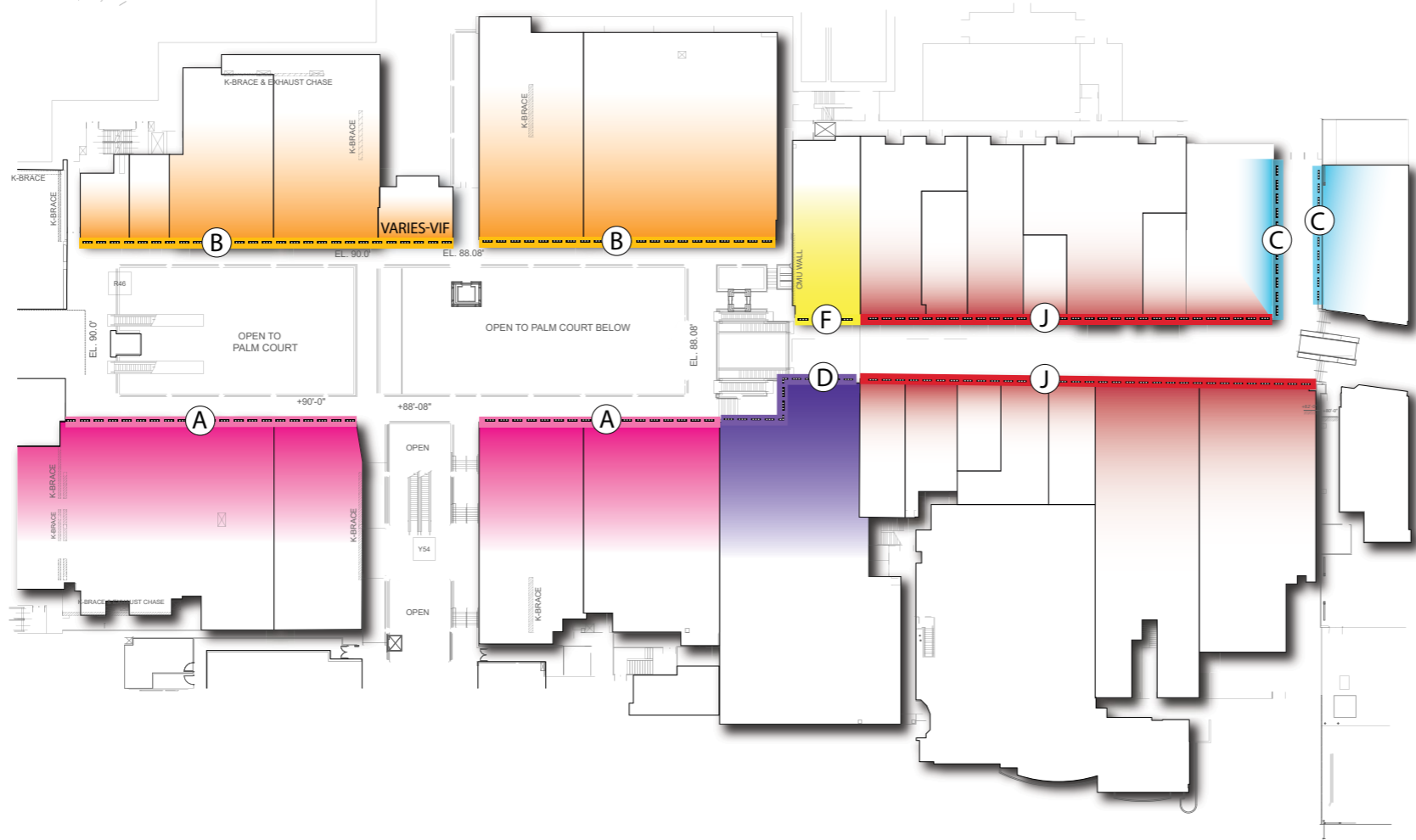
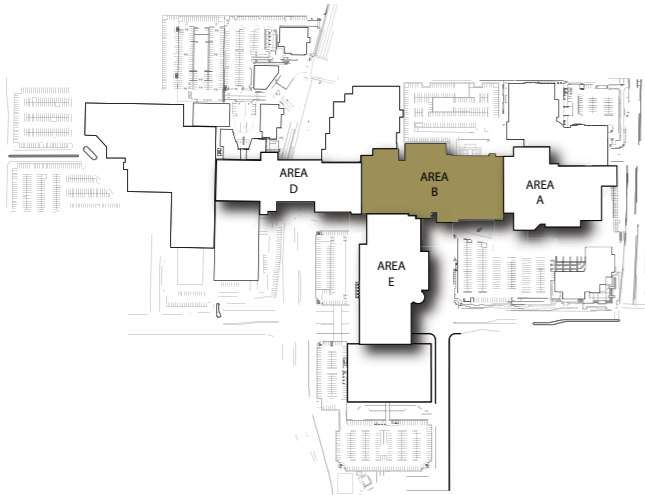







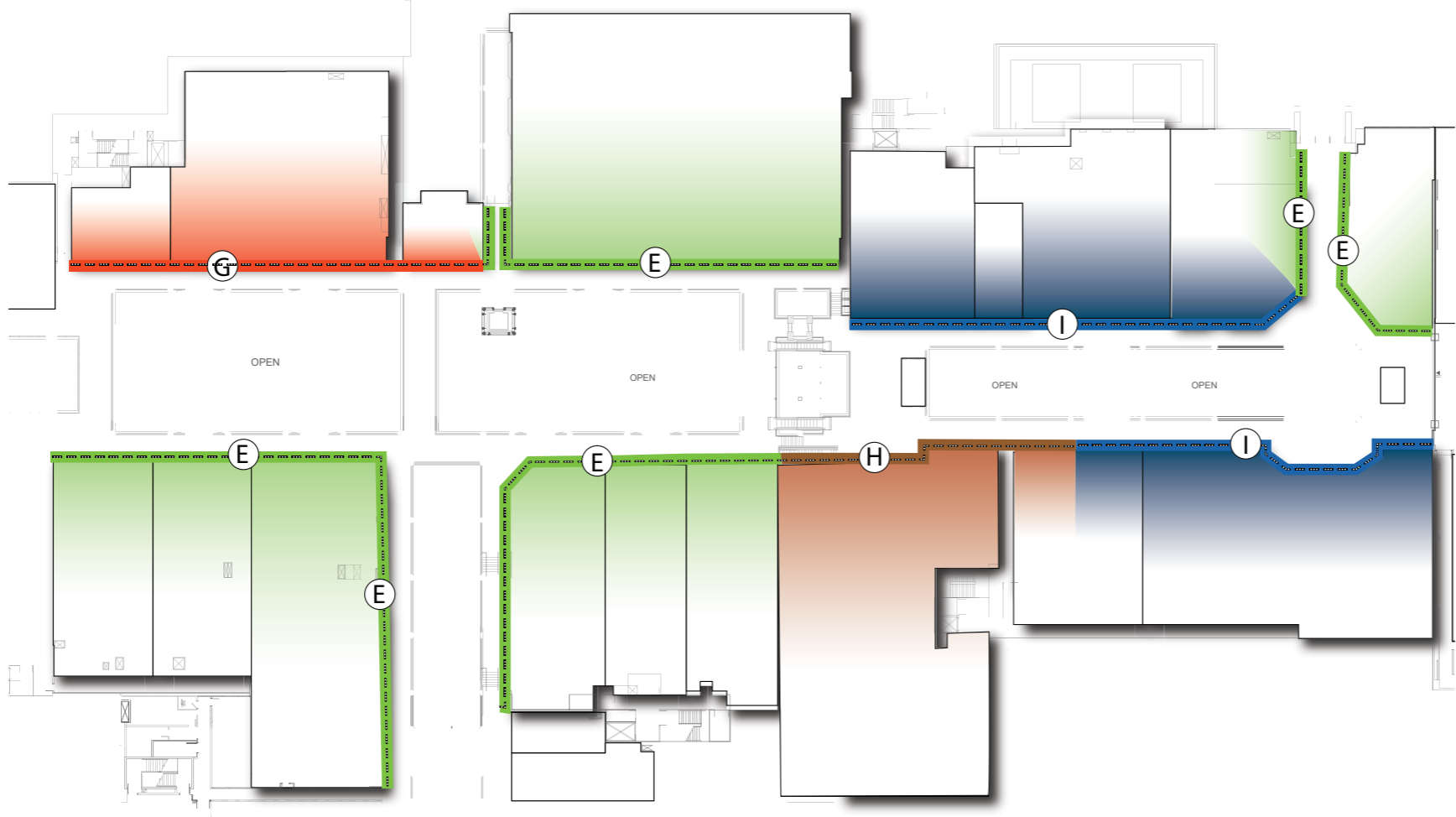
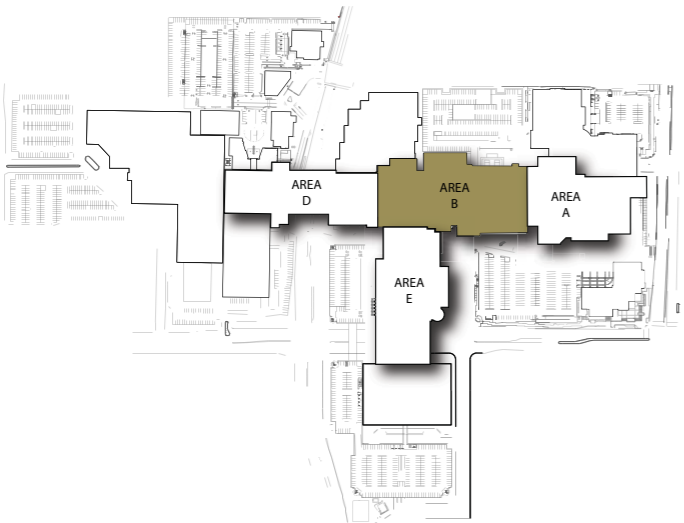



AREA B FIRST LEVEL

STOREFRONT CONDITIONS	
	TYPE A 10'-6" TENANT STOREFRONT TO INCLUDE 4" REVEAL
	TYPE B 10'-8" TENANT STOREFRONT TO INCLUDE 4" REVEAL
	TYPE C 10'-10" TENANT STOREFRONT TO INCLUDE 4" REVEAL
	TYPE D 11'-3" TENANT STOREFRONT TO INCLUDE 4" REVEAL
	TYPE E 12'-0" TENANT STOREFRONT TO INCLUDE 4" REVEAL
	TYPE F 12'-6" TENANT STOREFRONT TO INCLUDE 4" REVEAL
	TYPE G 13'-0" TENANT STOREFRONT TO INCLUDE 4" REVEAL
	TYPE H 13'-6" TENANT STOREFRONT TO INCLUDE 4" REVEAL
	TYPE I 13'-7" TENANT STOREFRONT TO INCLUDE 4" REVEAL
	TYPE J 14'-6" TENANT STOREFRONT TO INCLUDE 4" REVEAL

MALL ZONES > STOREFRONT CONDITIONS > AREA B



AREA B SECOND LEVEL

STOREFRONT CONDITIONS	
	TYPE A 10'-6" TENANT STOREFRONT TO INCLUDE 4" REVEAL
	TYPE B 10-8" TENANT STOREFRONT TO INCLUDE 4" REVEAL
	TYPE C 10'-10" TENANT STOREFRONT TO INCLUDE 4" REVEAL
	TYPE D 11'-3" TENANT STOREFRONT TO INCLUDE 4" REVEAL
	TYPE E 12'-0" TENANT STOREFRONT TO INCLUDE 4" REVEAL
	TYPE F 12'-6" TENANT STOREFRONT TO INCLUDE 4" REVEAL
	TYPE G 13'-0" TENANT STOREFRONT TO INCLUDE 4" REVEAL
	TYPE H 13'-6" TENANT STOREFRONT TO INCLUDE 4" REVEAL
	TYPE I 13'-7" TENANT STOREFRONT TO INCLUDE 4" REVEAL
	TYPE J 14'-6" TENANT STOREFRONT TO INCLUDE 4" REVEAL

MALL ZONES > STOREFRONT CONDITIONS > AREA B

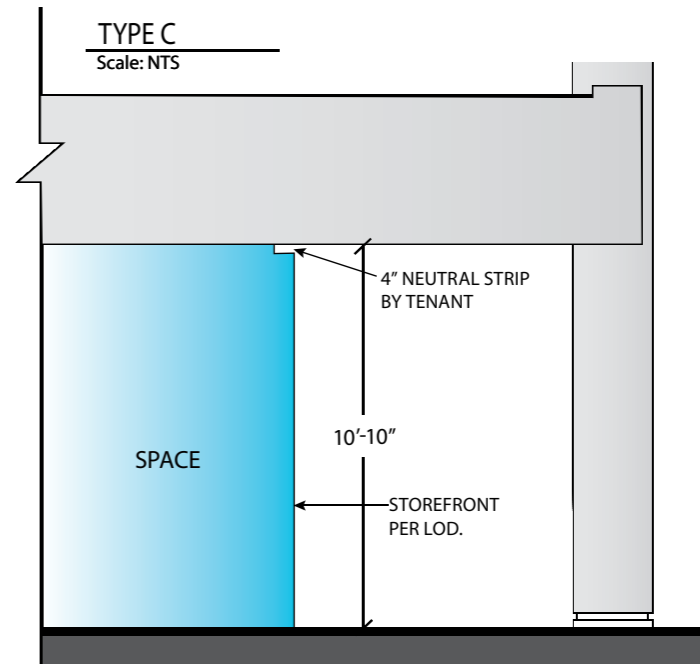
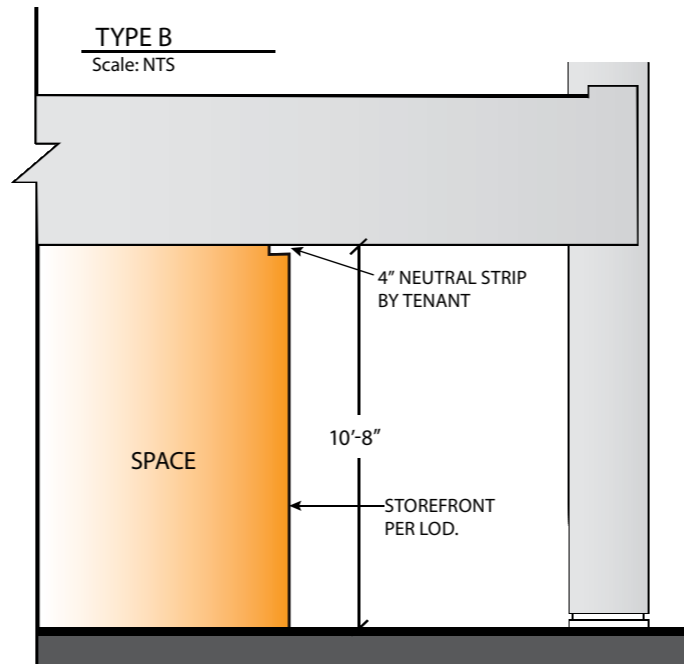
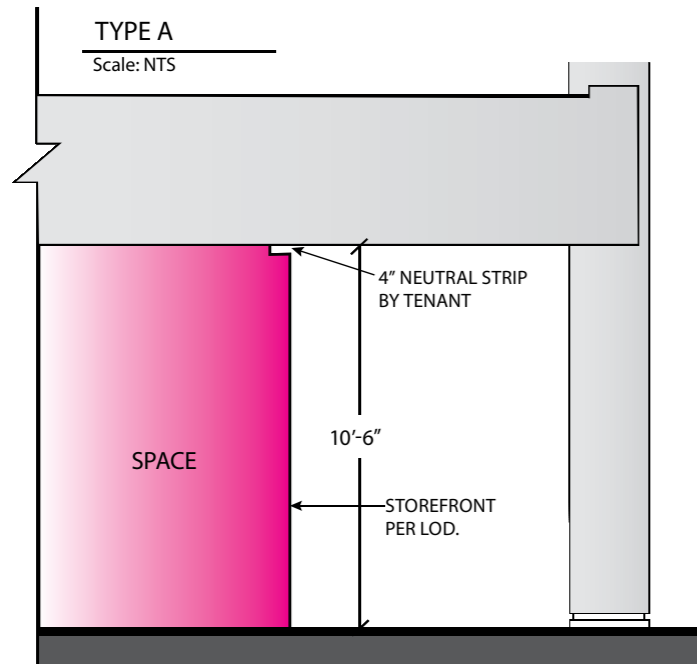
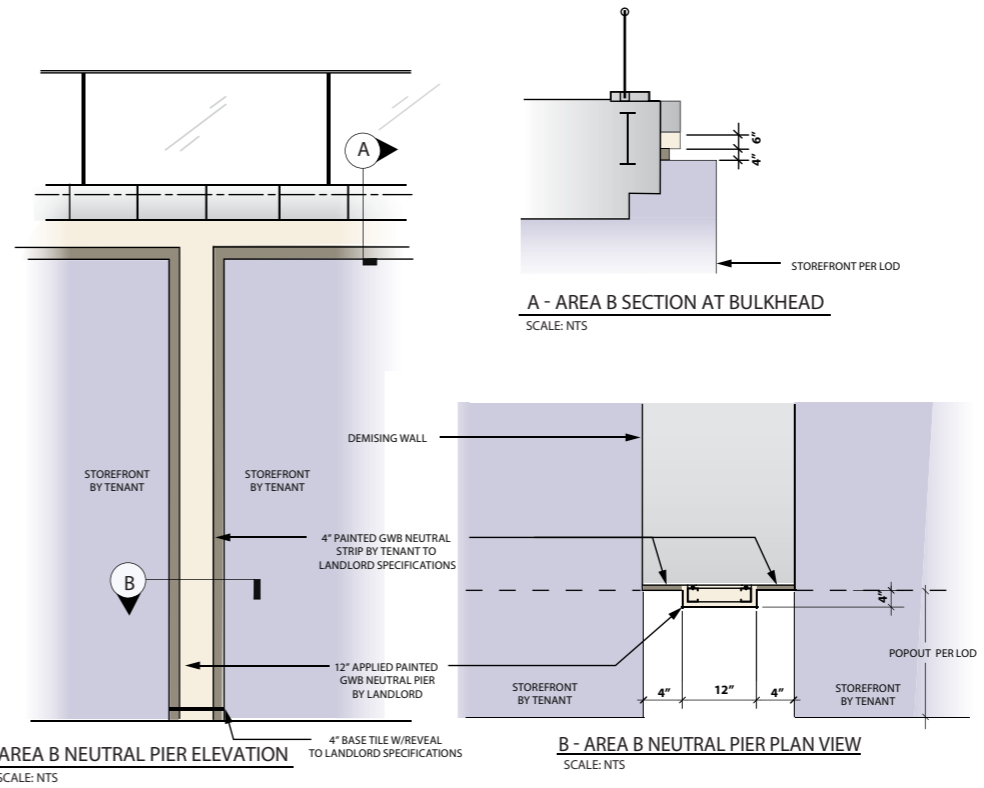
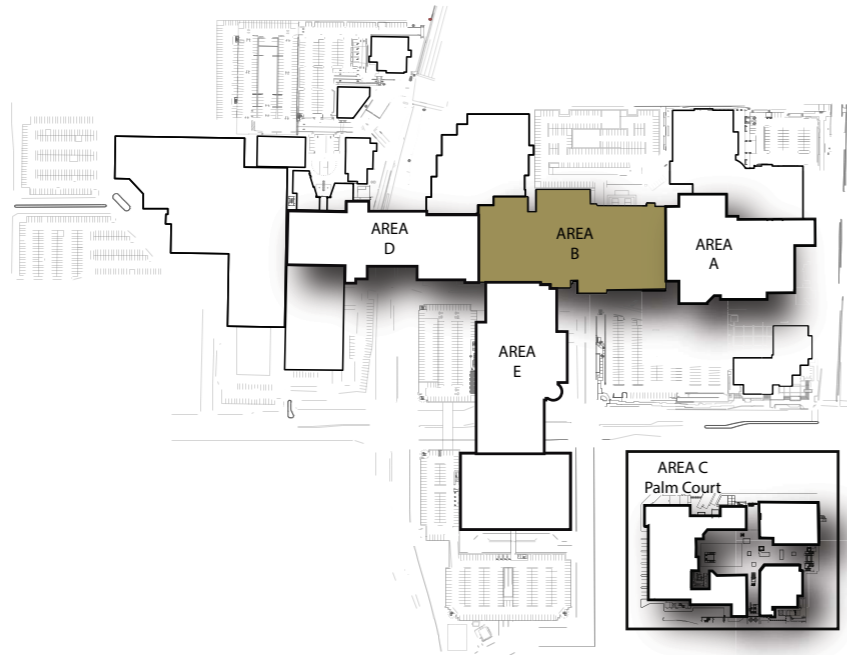

MALL ZONES > STOREFRONT CONDITIONS > AREA B

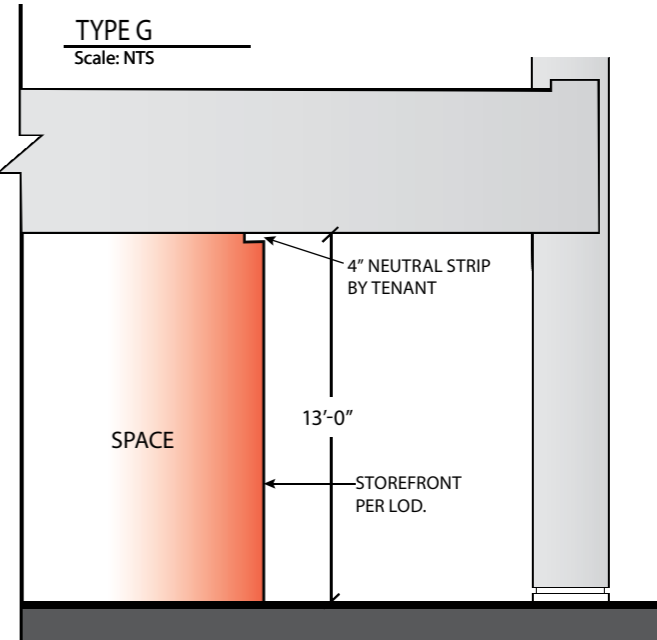
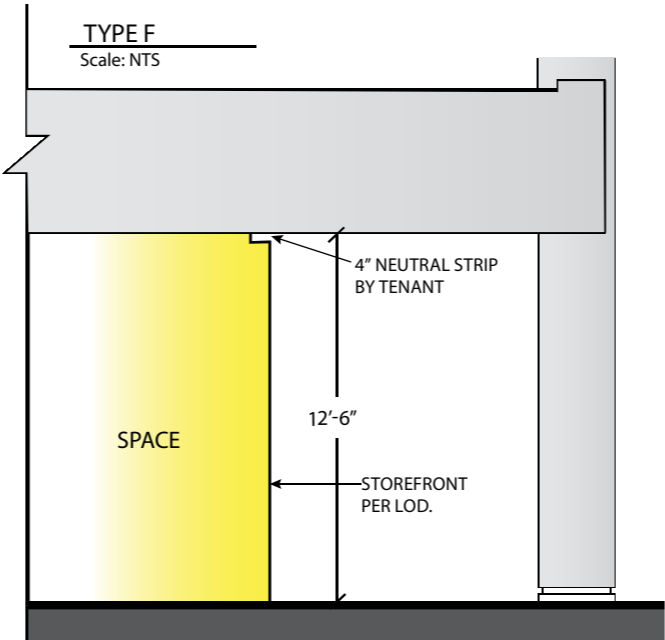
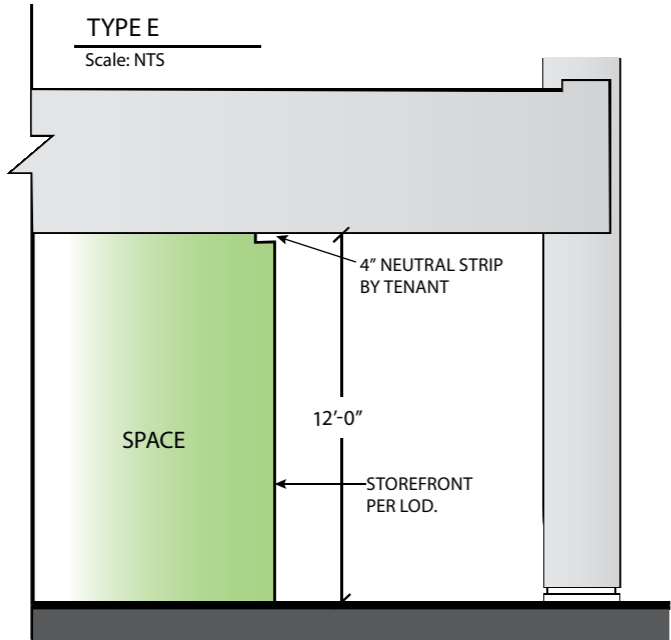
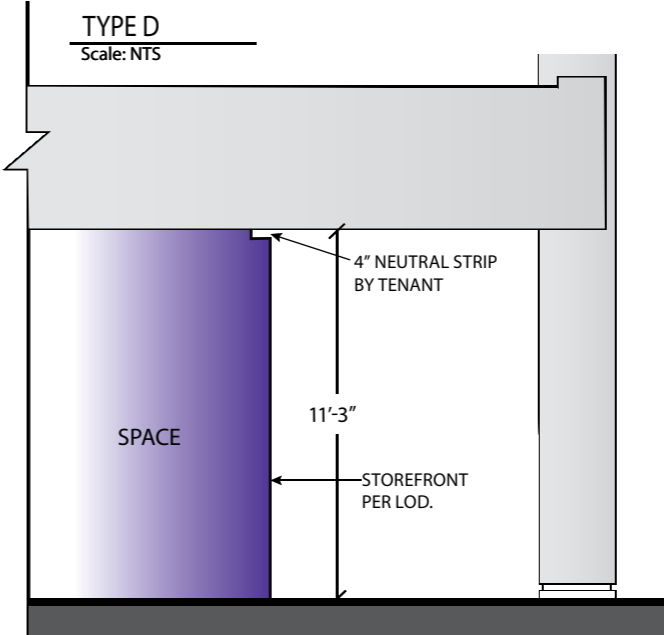
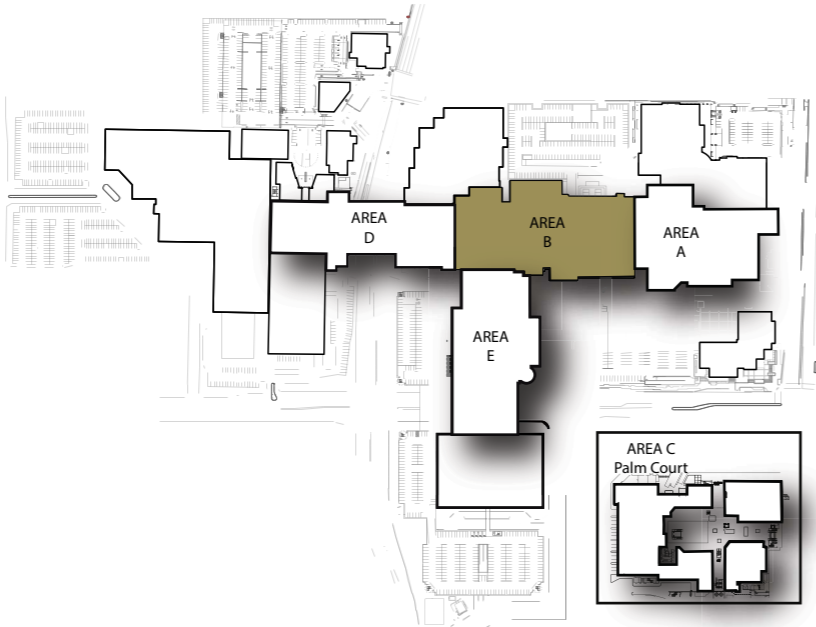

MALL ZONES > STOREFRONT CONDITIONS > AREA B

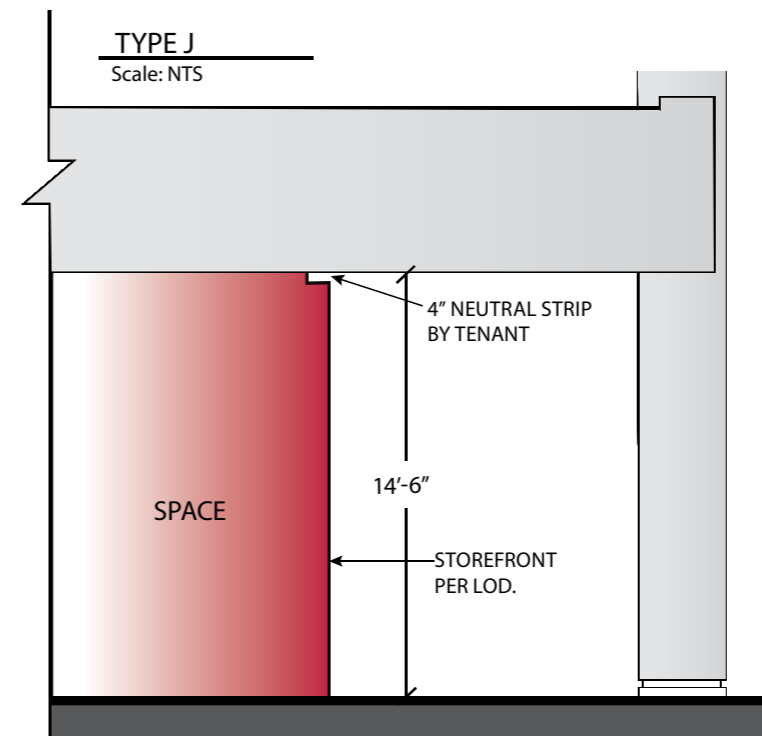
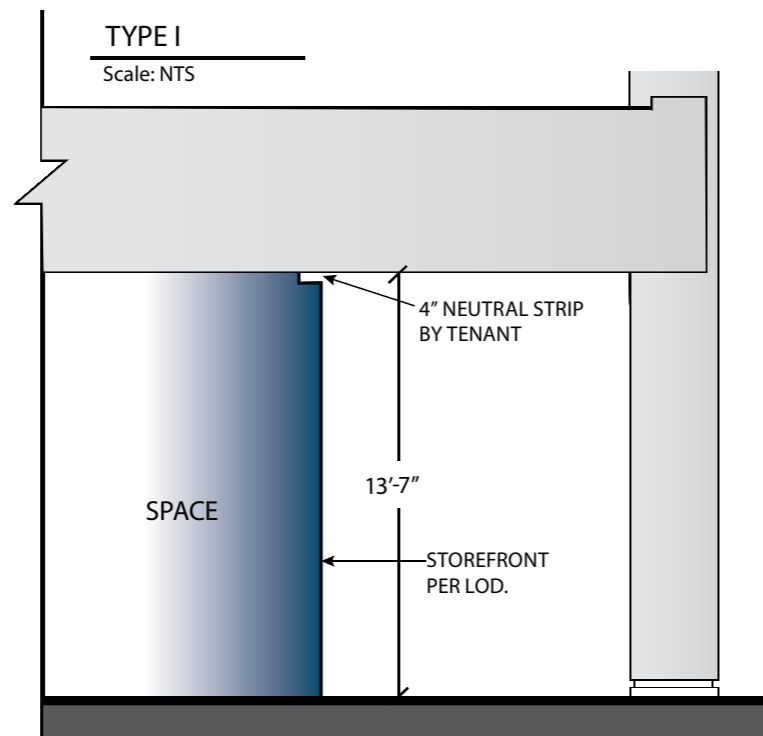
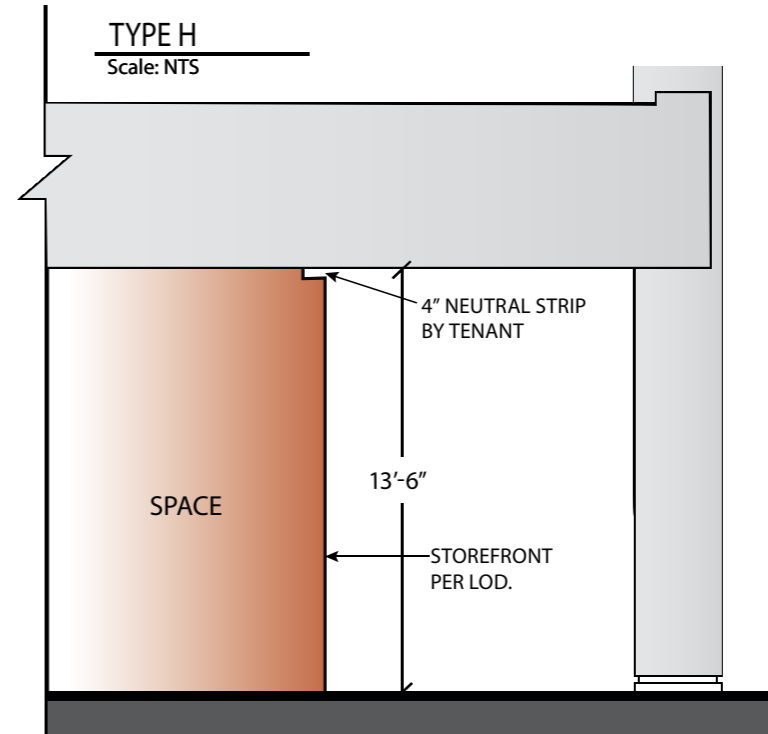
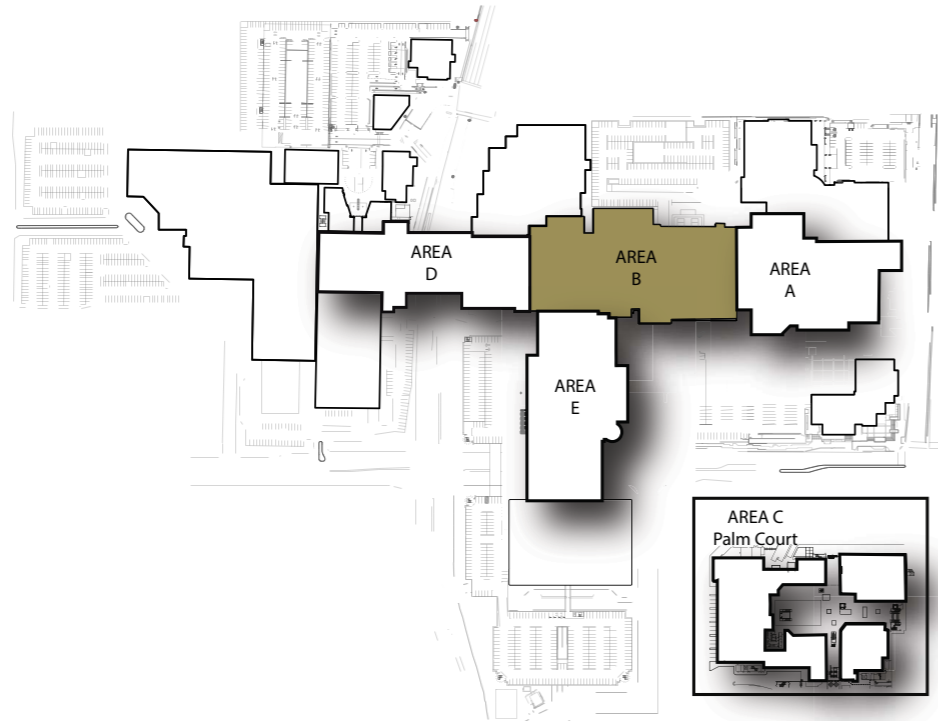

MALL ZONES > STOREFRONT CONDITIONS > AREA C

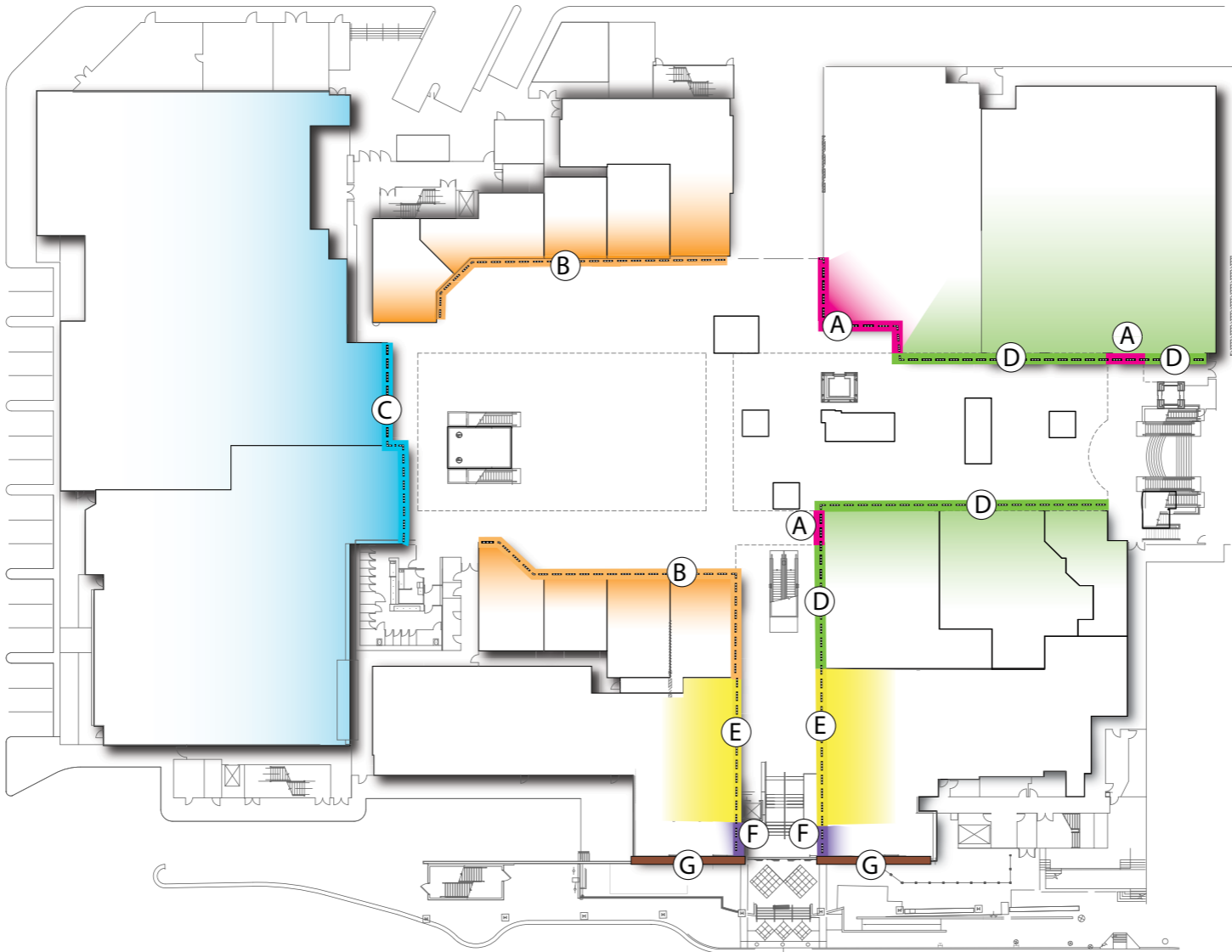
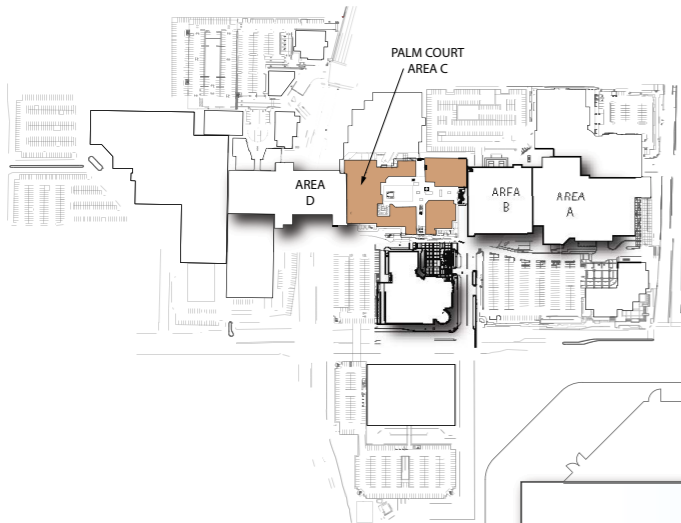

AREA C PALM COURT LEVEL

STOREFRONT CONDITIONS

	TYPE A 10'-10" TENANT STOREFRONT TO INCLUDE 4" REVEAL
	TYPE B FOOD COURT TENANT 8'-10" TO SOFFIT
	TYPE C 11'-7" TENANT STOREFRONT TO INCLUDE 4" REVEAL
	TYPE D 12'-9" TENANT STOREFRONT TO INCLUDE 4" REVEAL
	TYPE E 15'-4" TENANT STOREFRONT TO INCLUDE 4" REVEAL
	TYPE F 9'-4" TENANT STOREFRONT
	TYPE G

MALL ZONES > STOREFRONT CONDITIONS > AREA C

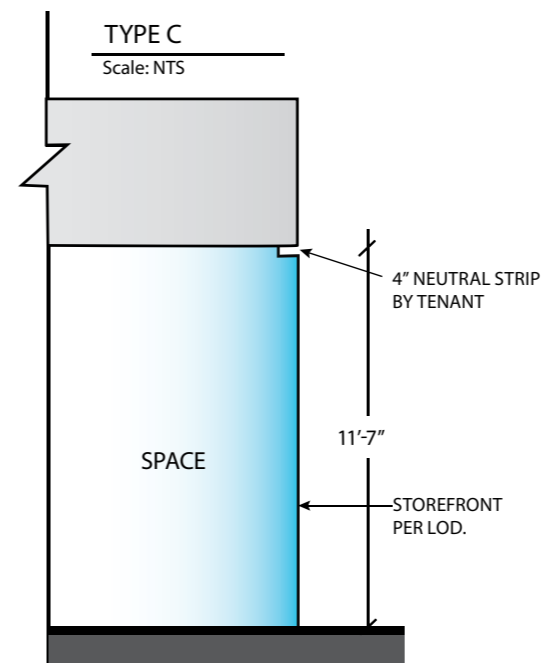
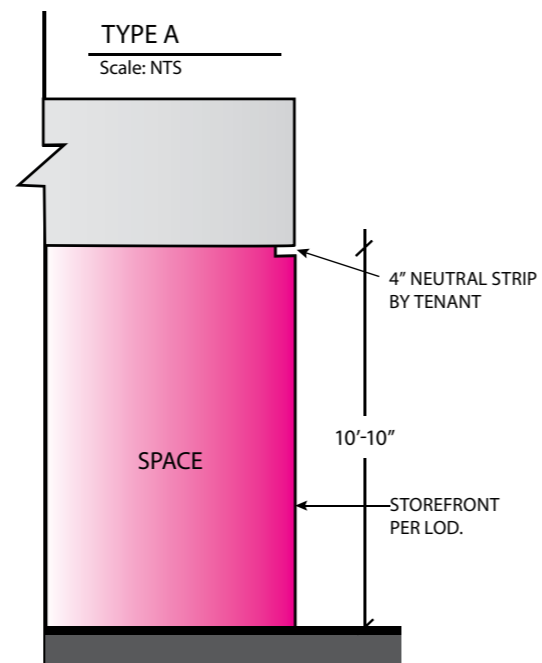
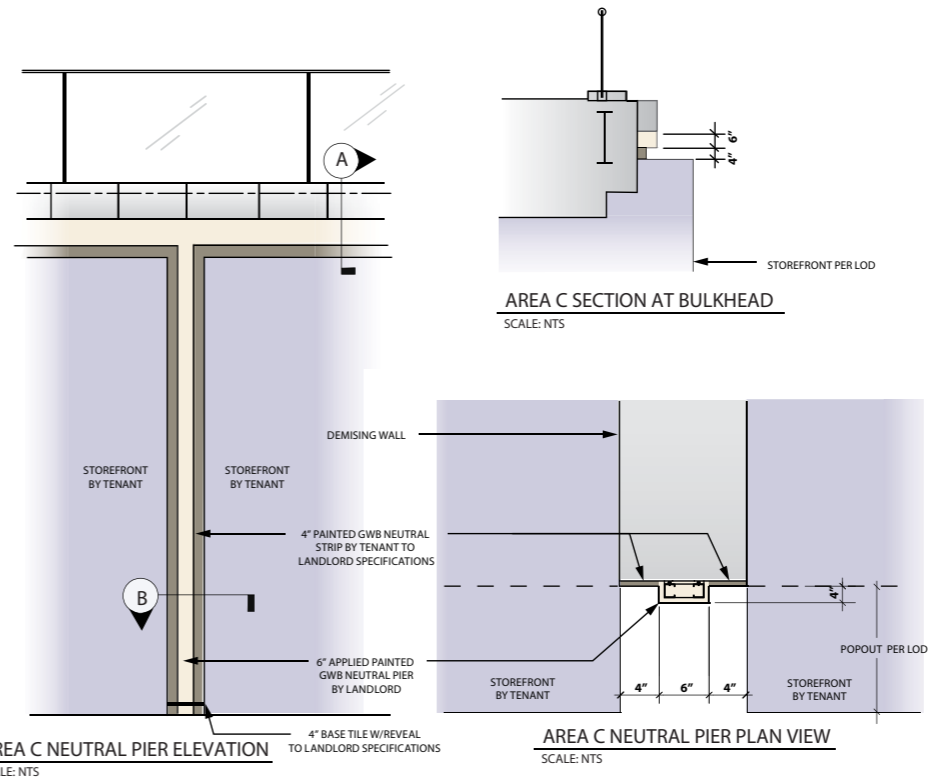
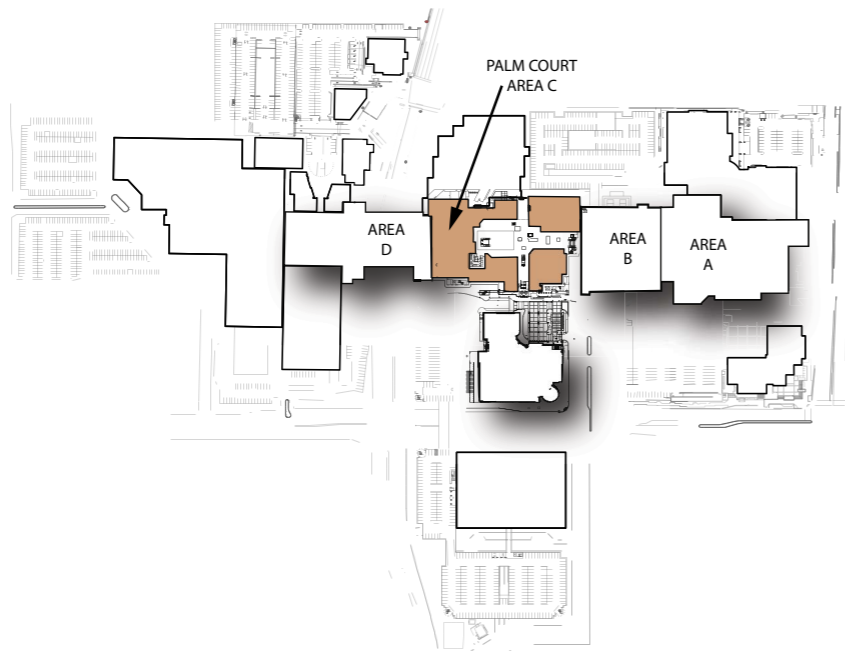

MALL ZONES > STOREFRONT CONDITIONS > AREA C

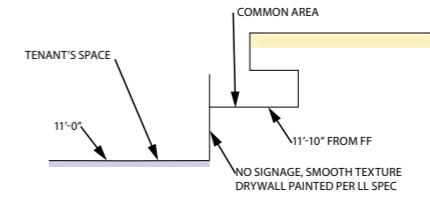
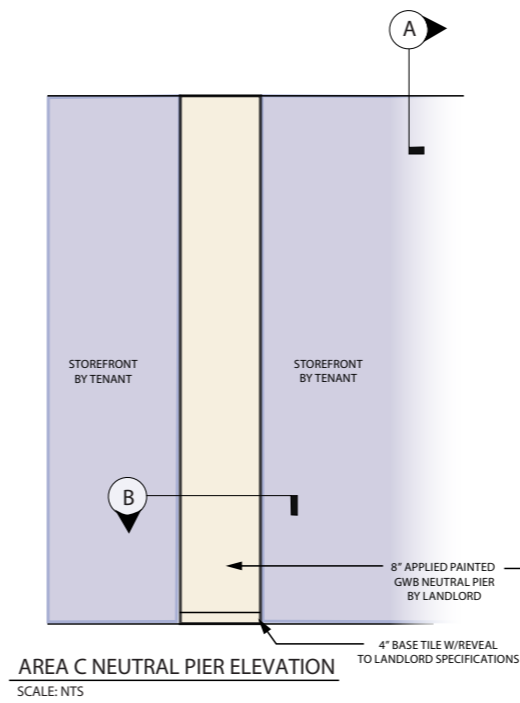
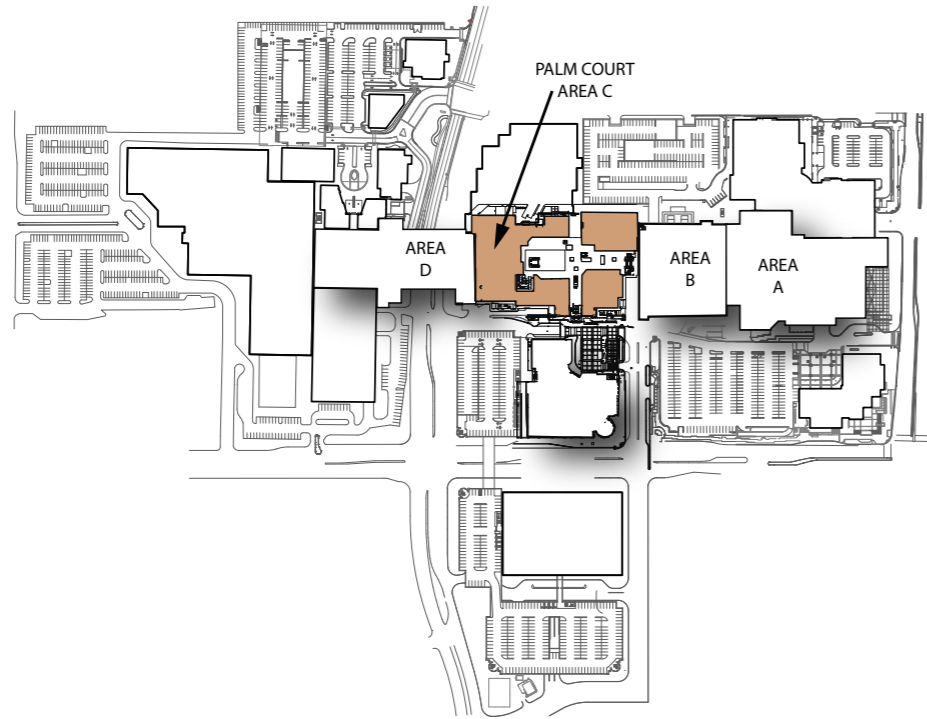

A - AREA C SECTION AT BULKHEAD
SCALE: NTS

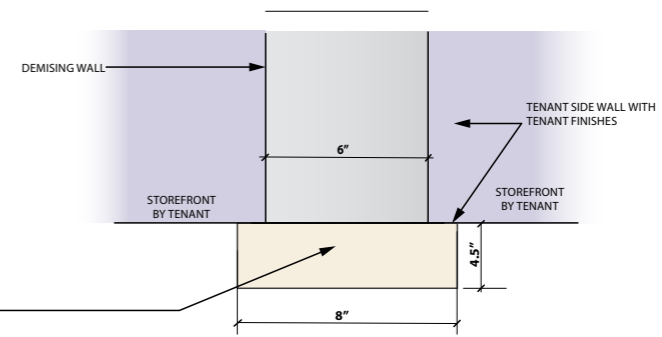

B - AREA C NEUTRAL PIER PLAN VIEW
SCALE: NTS

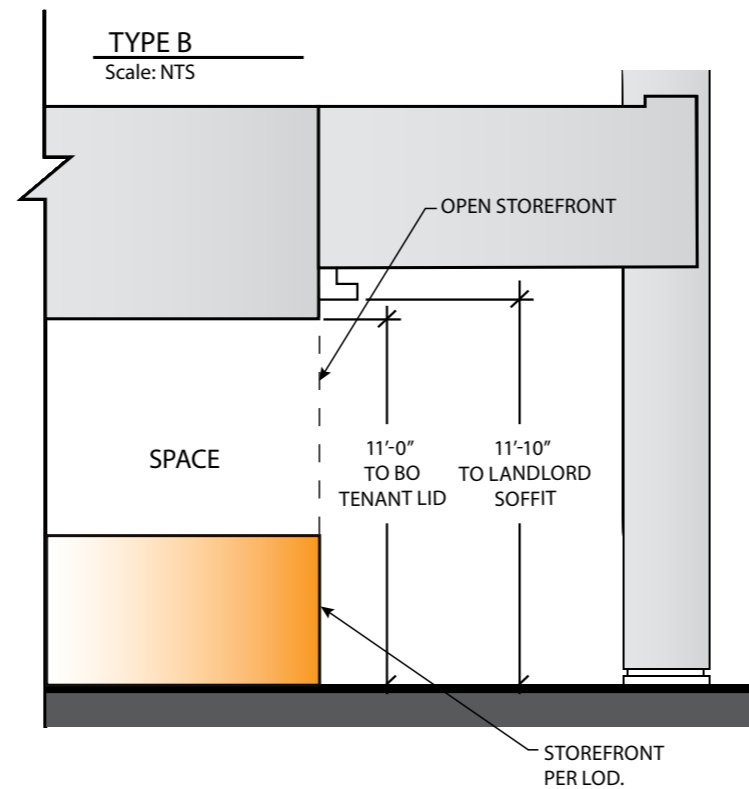

MALL ZONES > STOREFRONT CONDITIONS > AREA C

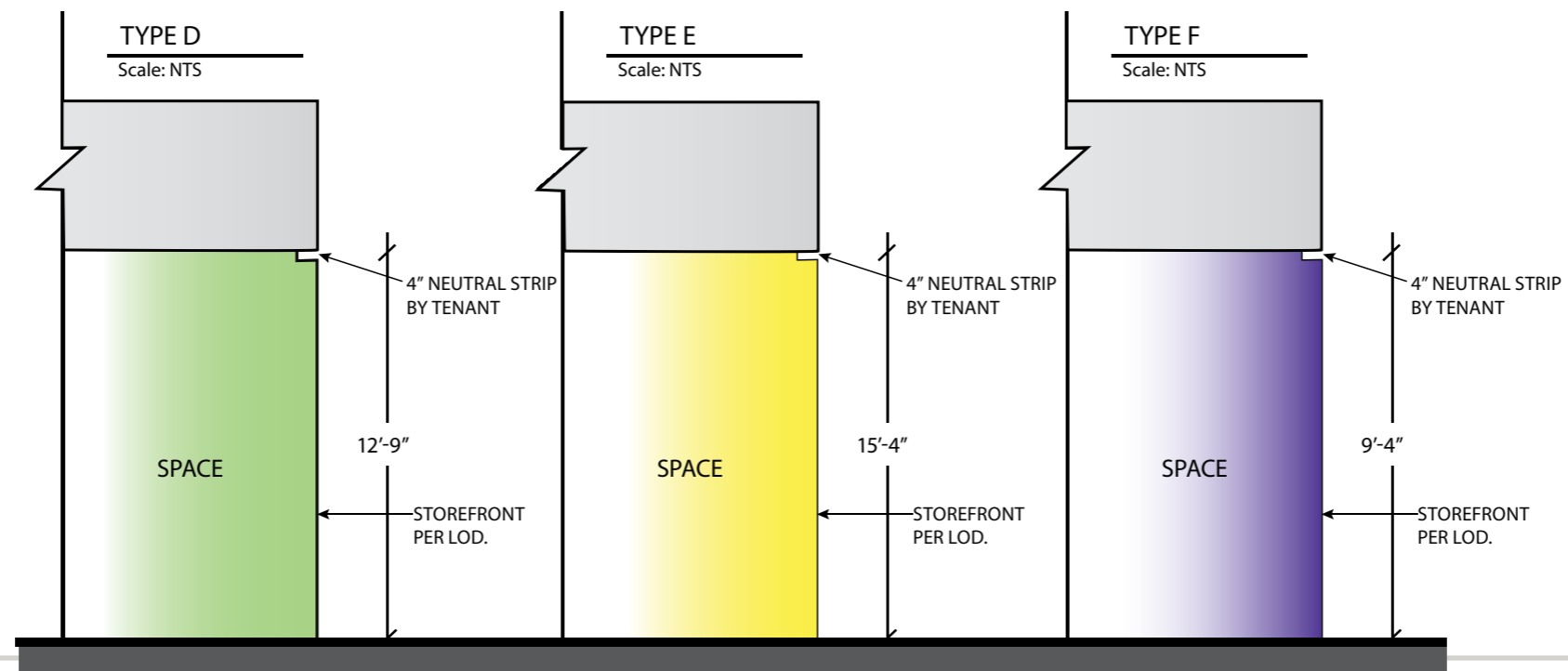
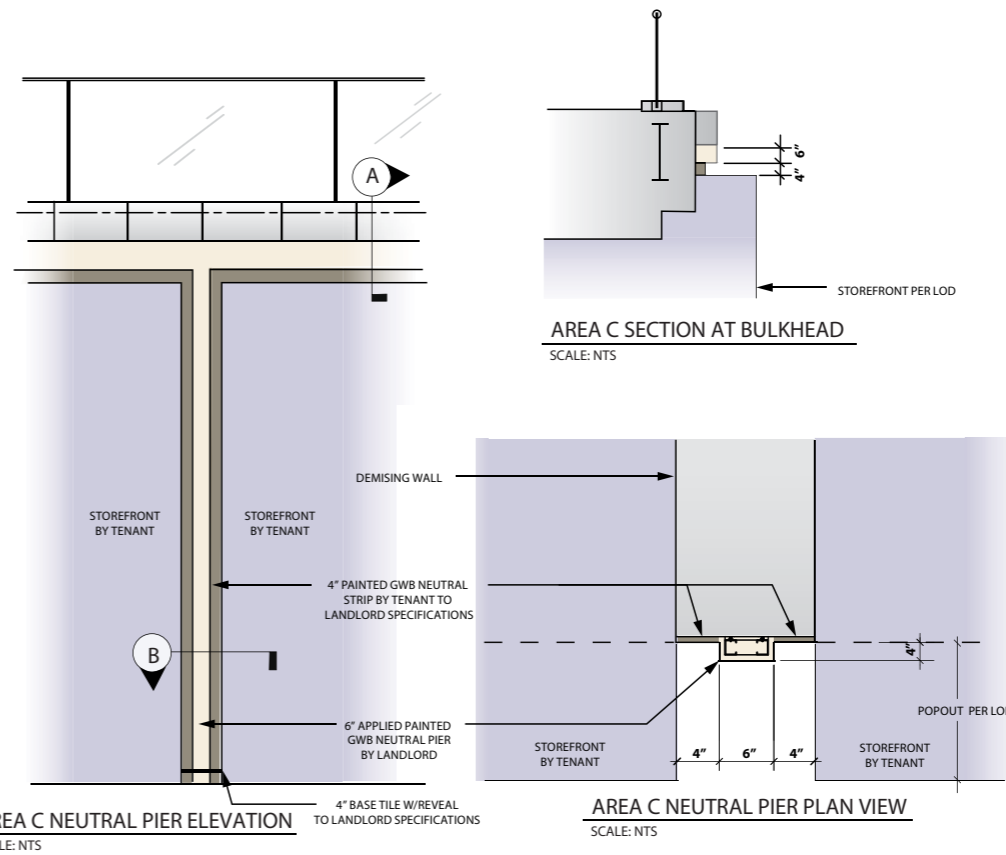
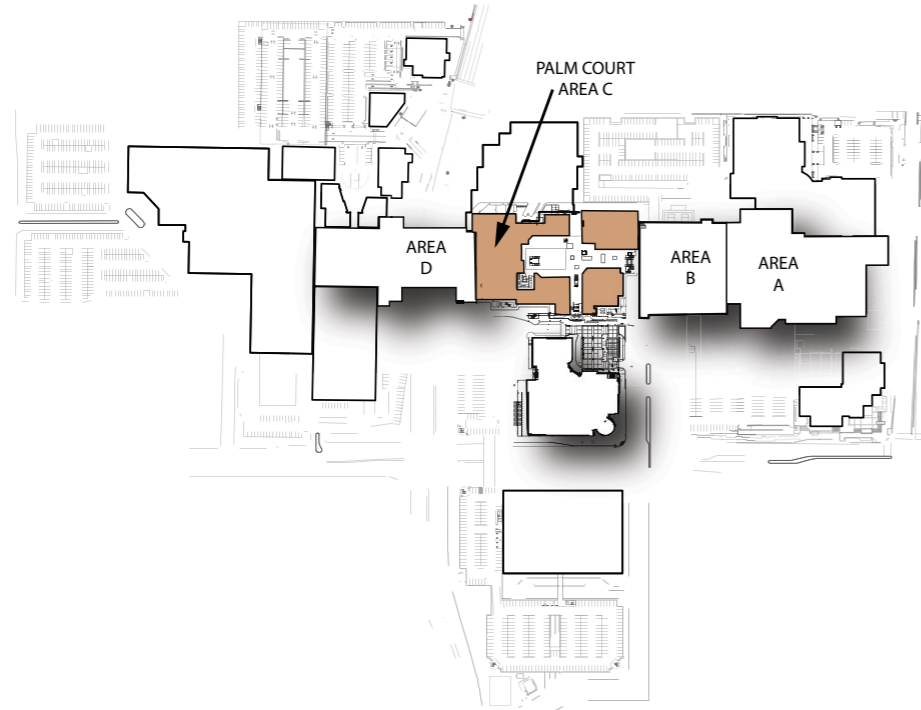

MALL ZONES > STOREFRONT CONDITIONS > AREA C

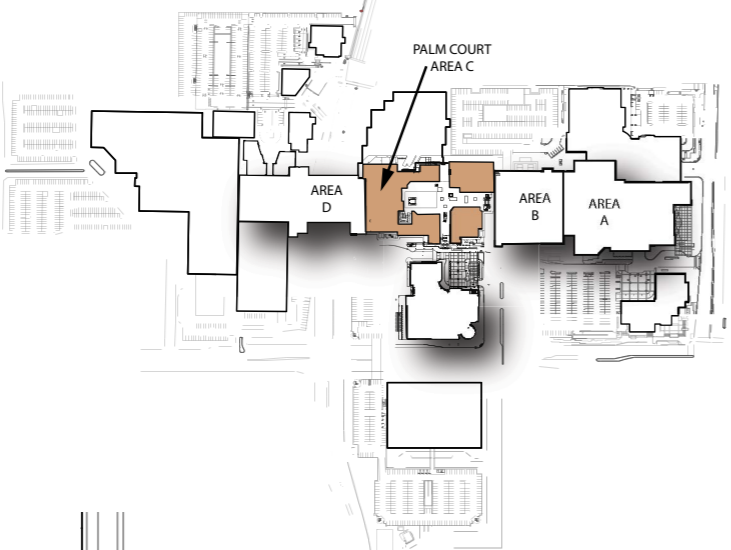

AREA C
TYPE G
Scale: NTS

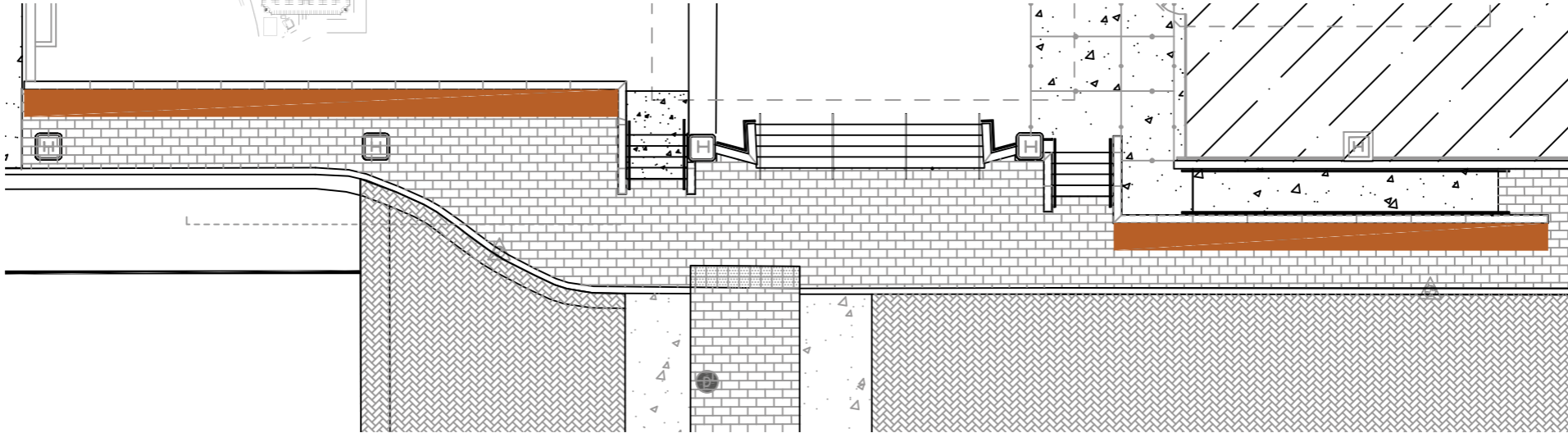

It is the responsibility of the Tenant occupying the space behind these walls to apply Tenant finish to the south face of these walls - to treat them as an extension of their storefront. At the Tenant's discretion, Tenants may also finish the north face of the same walls.

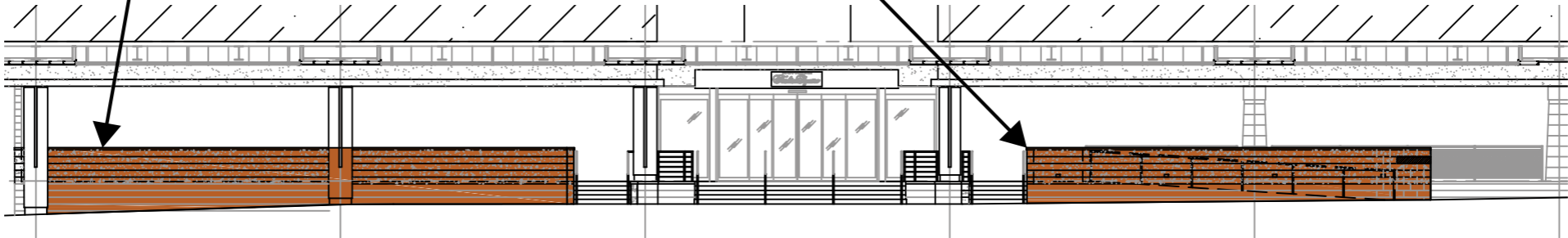

MALL ZONES > STOREFRONT CONDITIONS > AREA D

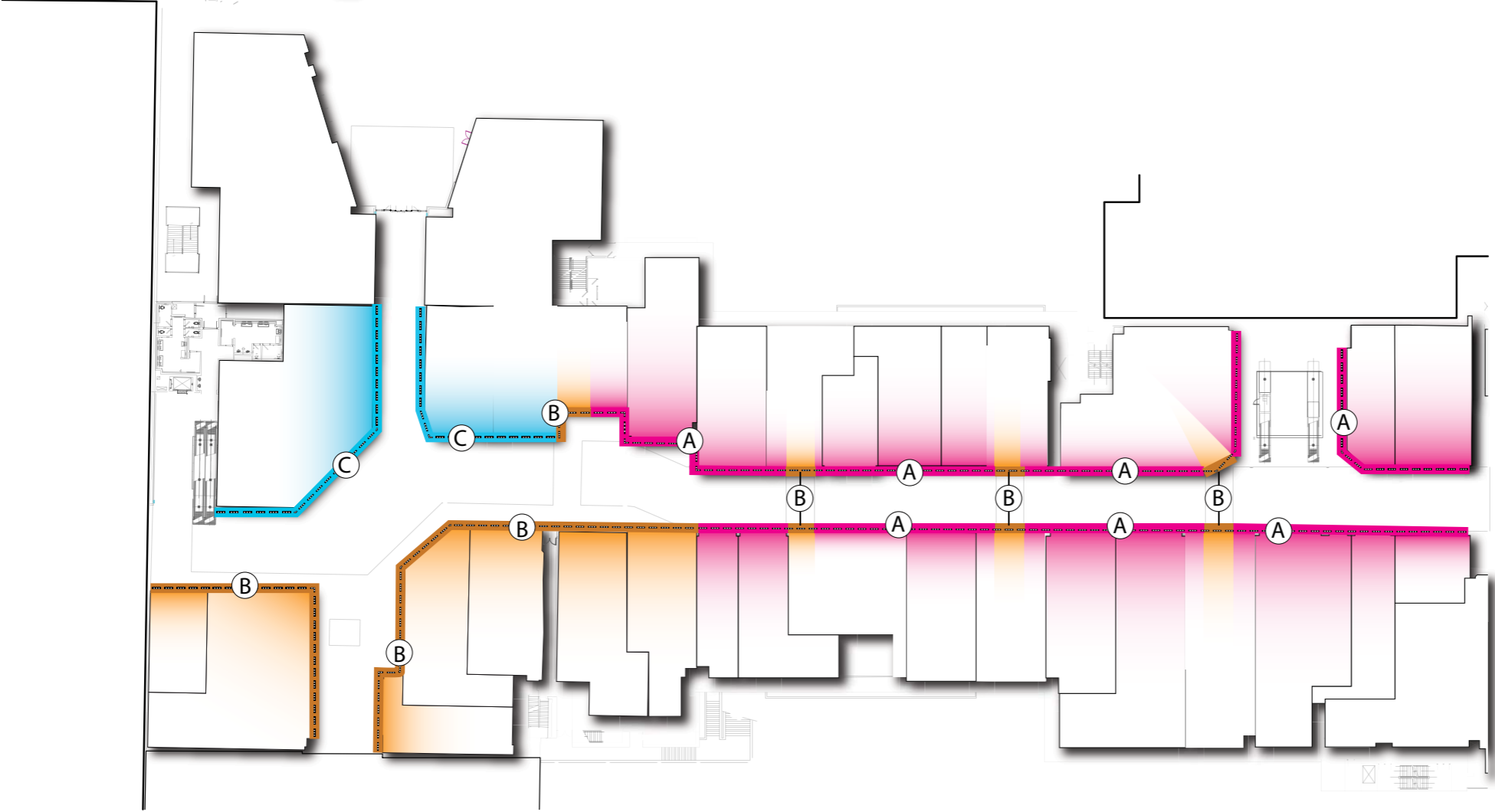
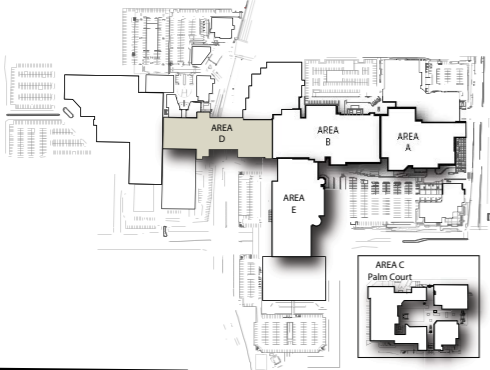

**AREA D
FIRST LEVEL**

STOREFRONT CONDITIONS

	<p>TYPE A 11'-6" TENANT STOREFRONT TO INCLUDE 4" REVEAL</p>
	<p>TYPE B 10'-0" TENANT STOREFRONT TO INCLUDE 4" REVEAL</p>
	<p>TYPE C 30'-6" TENANT STOREFRONT TO INCLUDE 4" REVEAL</p>

MALL ZONES > STOREFRONT CONDITIONS > AREA D

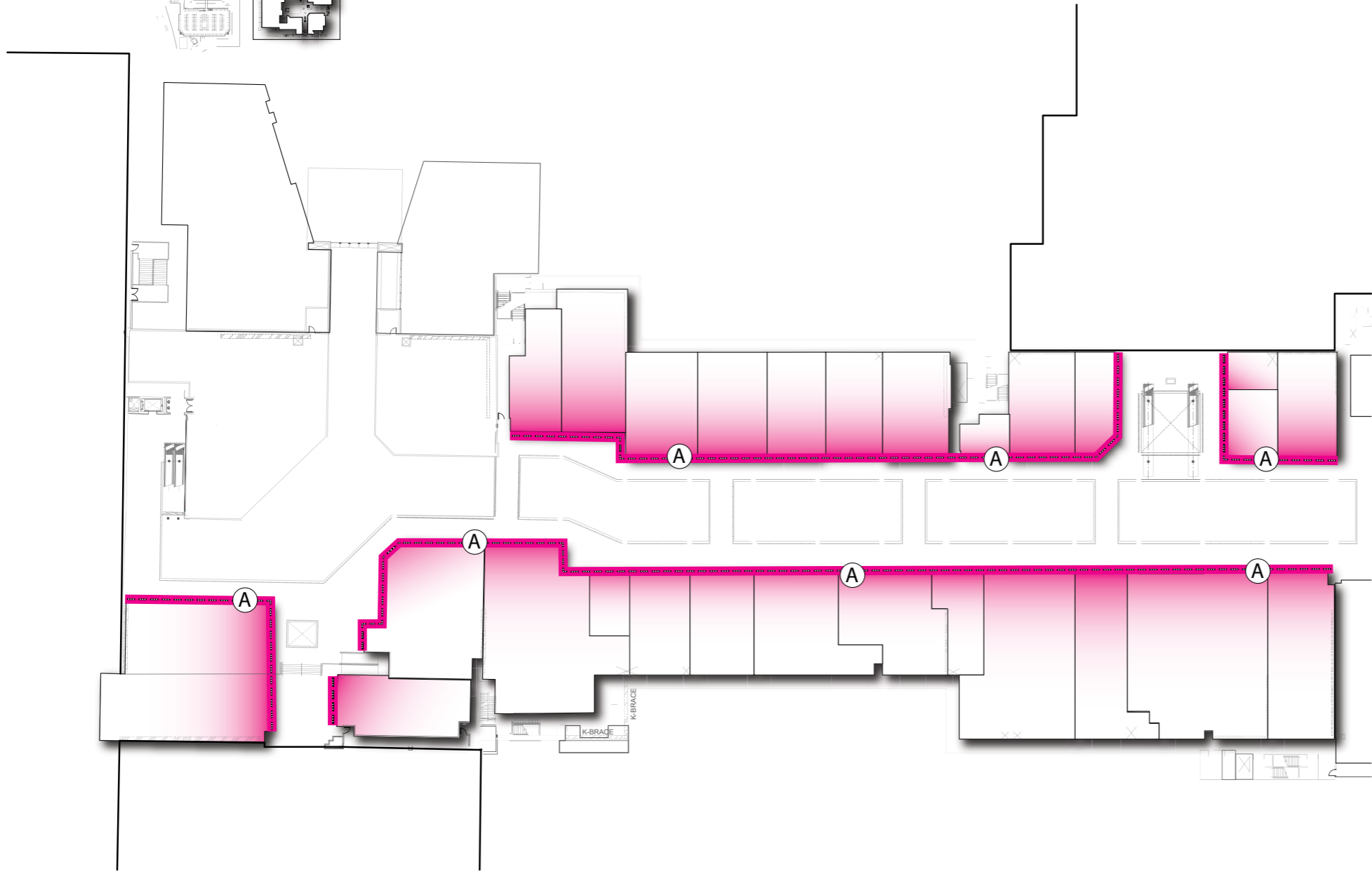
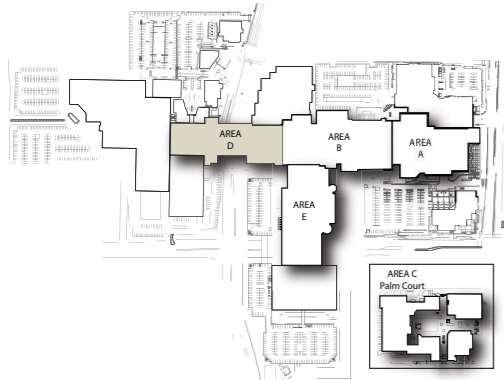

**AREA D
SECOND LEVEL**

STOREFRONT CONDITIONS

	TYPE A	11'-6" TENANT STOREFRONT TO INCLUDE 4" REVEAL
	TYPE B	10'-0" TENANT STOREFRONT TO INCLUDE 4" REVEAL
	TYPE C	30'-6" TENANT STOREFRONT TO INCLUDE 4" REVEAL

MALL ZONES > STOREFRONT CONDITIONS > AREA D

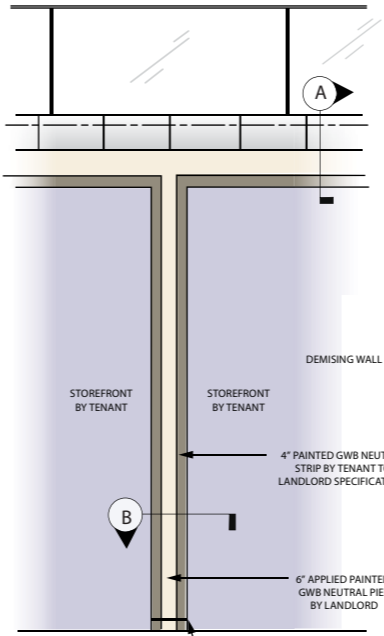
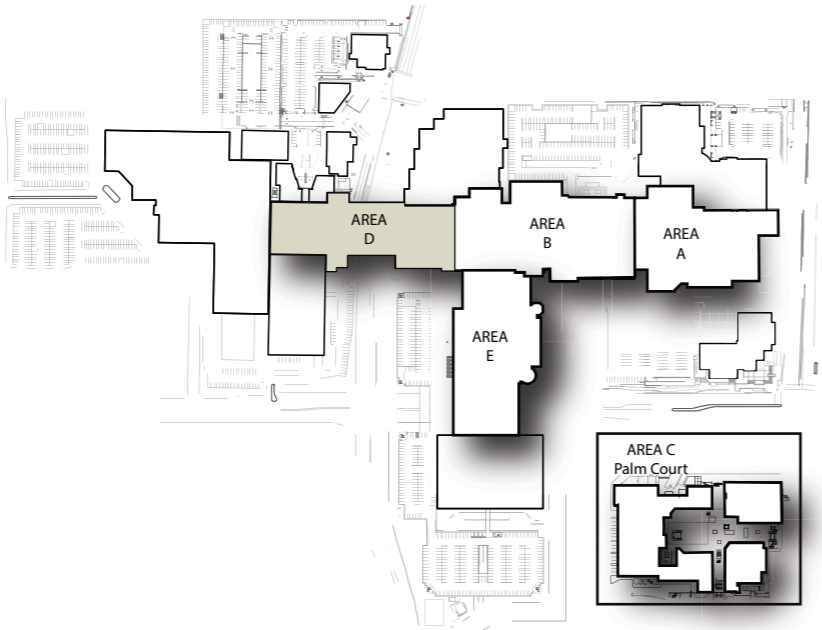

AREA D NEUTRAL PIER ELEVATION
SCALE: NTS

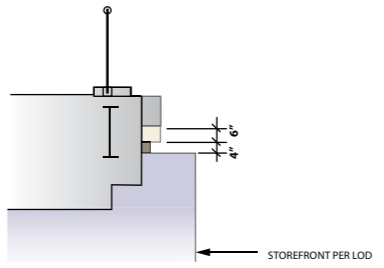

AREA D SECTION AT BULKHEAD
SCALE: NTS

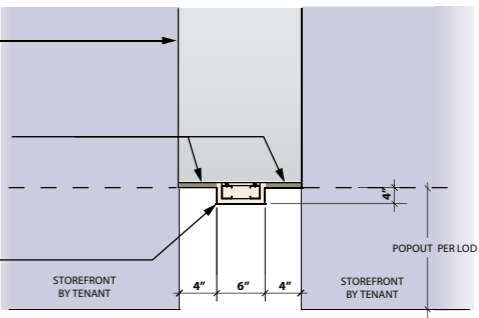

AREA D NEUTRAL PIER PLAN VIEW
SCALE: NTS

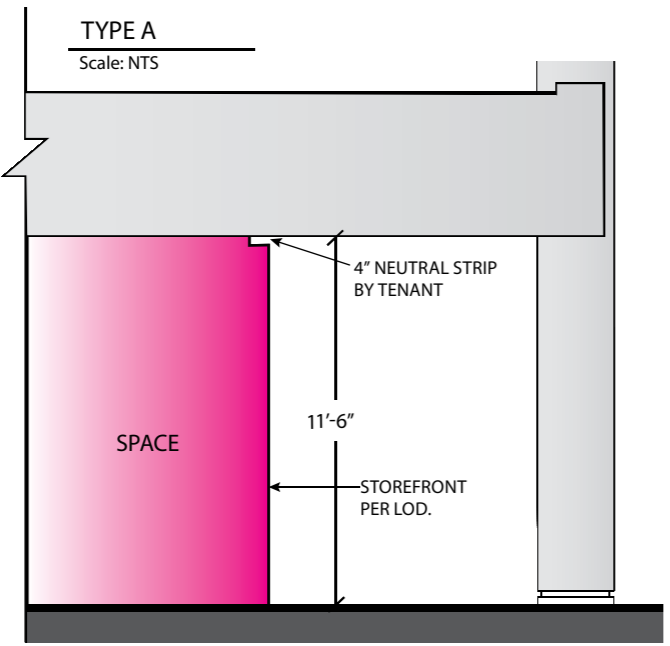

TYPE A
Scale: NTS

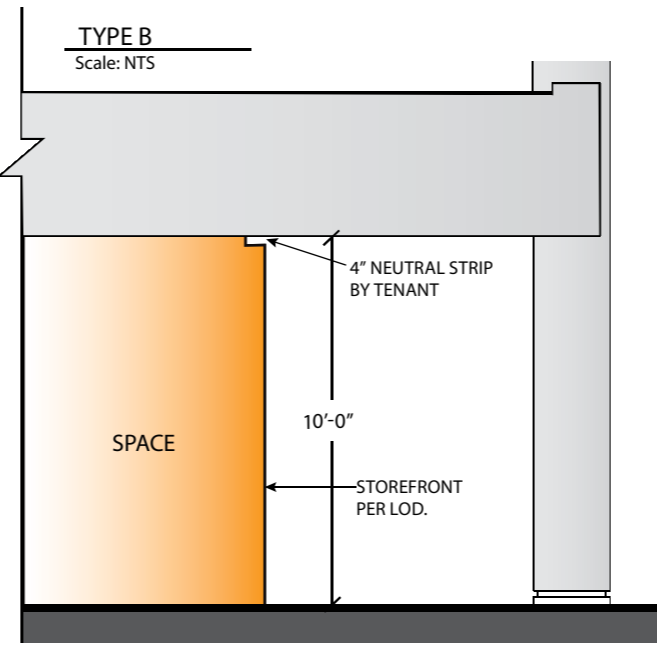

TYPE B
Scale: NTS

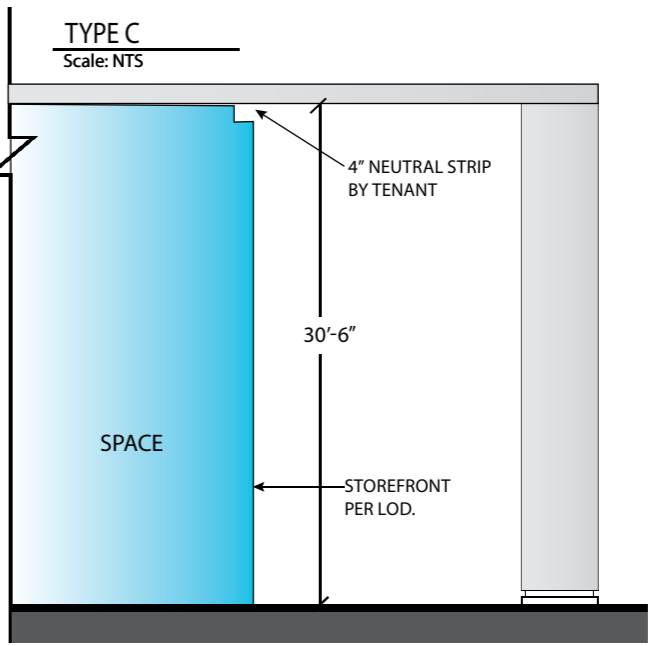

TYPE C
Scale: NTS

MALL ZONES > STOREFRONT CONDITIONS > AREA E

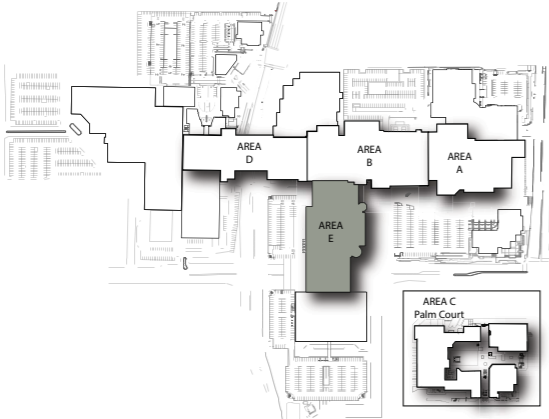

AREA E GRADE LEVEL

STOREFRONT CONDITIONS

- TYPE A** 12'-10" TENANT STOREFRONT TO INCLUDE 4" REVEAL
- TYPE B** 17'-4" TENANT STOREFRONT TO INCLUDE 4" REVEAL
- TYPE C** 13'-0" TENANT STOREFRONT TO INCLUDE 4" REVEAL
- TYPE D** 12'-11" TENANT STOREFRONT TO INCLUDE 4" REVEAL
- TYPE E** 15'-6" TENANT STOREFRONT TO INCLUDE 4" REVEAL
- TYPE F** 10'-8" TENANT STOREFRONT
TYPE F IN AREA E WILL NOT NEED A TYPICAL 4" REVEAL. THERE IS NOT A STANDARD NEUTRAL PIER DETAIL SEPARATING TENANTS FOR THIS TYPE. EACH TENANT STOREFRONT SHOULD BE DESIGNED TO BE DIRECTLY ADJACENT TO ANY NEIGHBORING TENANT STOREFRONT, HOWEVER THERE MUST BE A MINIMUM 3" OFFSET FROM THE FACE OF ONE STOREFRONT TO THE NEXT. THIS DETAIL MUST BE CAREFULLY COORDINATED WITH THE LANDLORD.

MALL ZONES > STOREFRONT CONDITIONS > AREA E

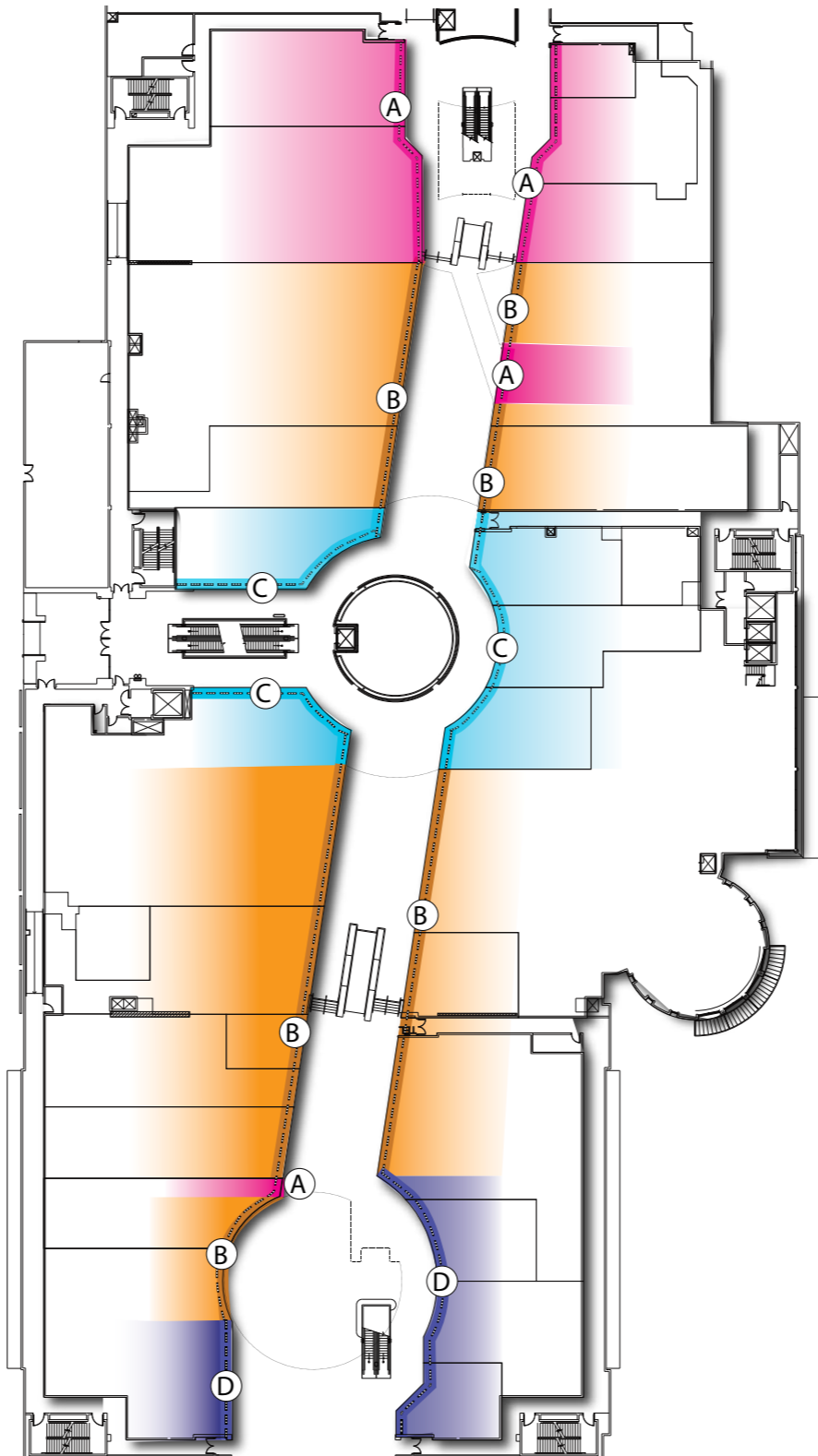
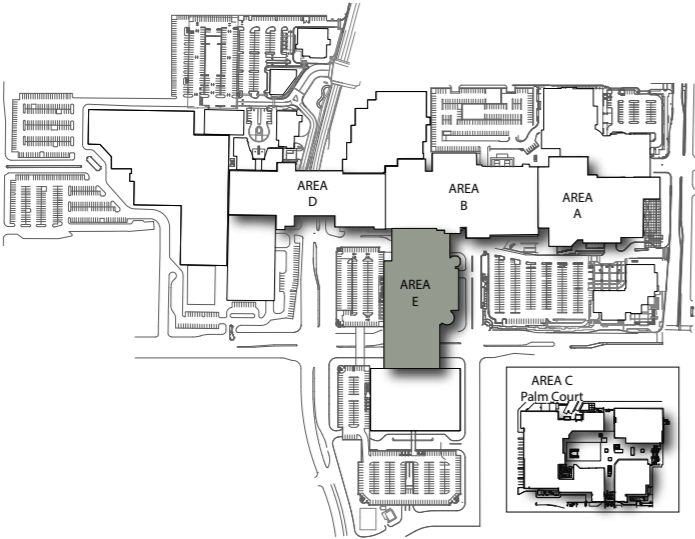

AREA E FIRST LEVEL

STOREFRONT CONDITIONS	
■ TYPE A	12'-10" TENANT STOREFRONT TO INCLUDE 4" REVEAL
■ TYPE B	17'-4" TENANT STOREFRONT TO INCLUDE 4" REVEAL
■ TYPE C	13'-0" TENANT STOREFRONT TO INCLUDE 4" REVEAL
■ TYPE D	12'-11" TENANT STOREFRONT TO INCLUDE 4" REVEAL
■ TYPE E	15'-6" TENANT STOREFRONT TO INCLUDE 4" REVEAL
■ TYPE F	10'-8" TENANT STOREFRONT TO INCLUDE 4" REVEAL

MALL ZONES > STOREFRONT CONDITIONS > AREA E

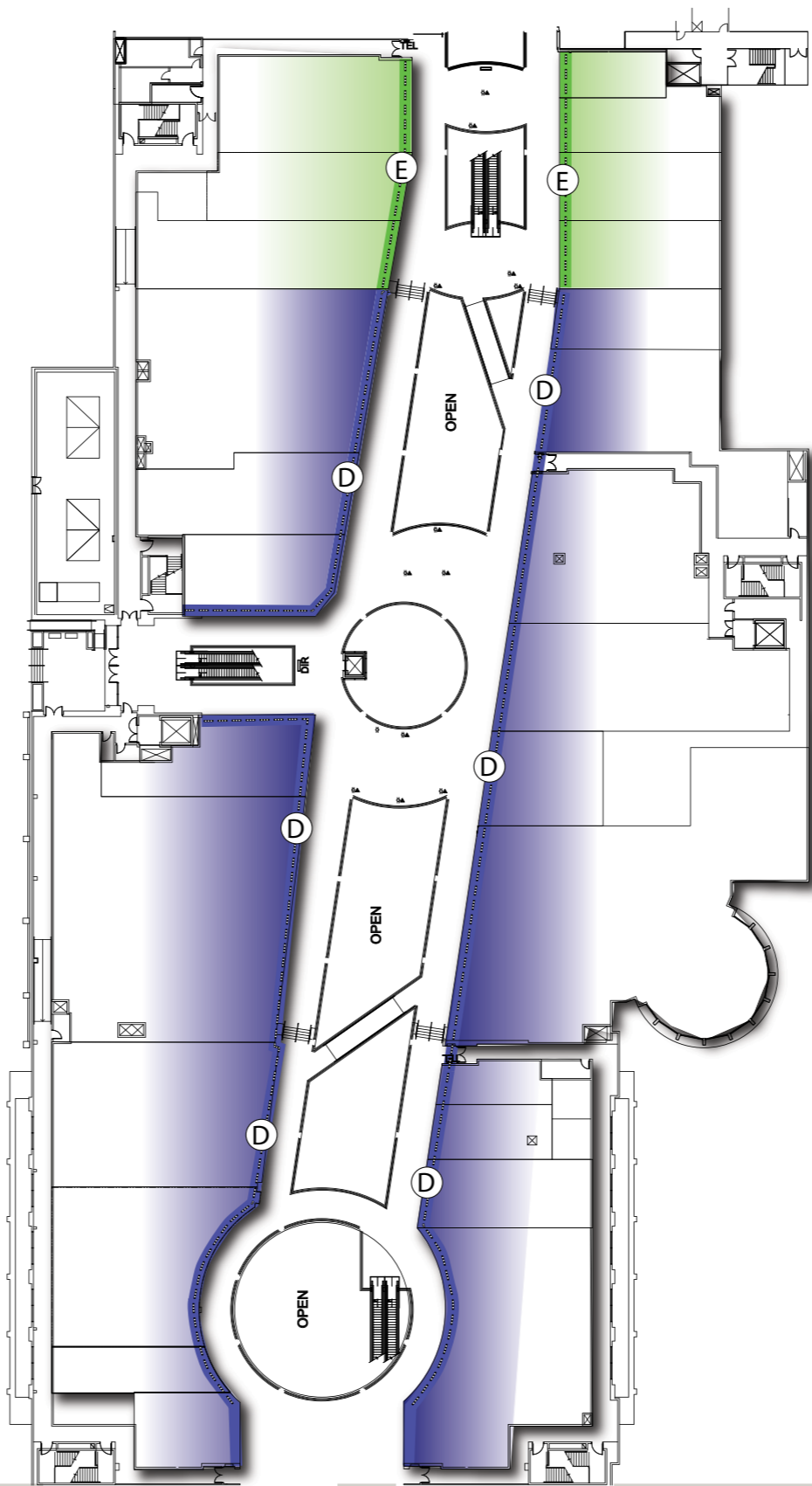
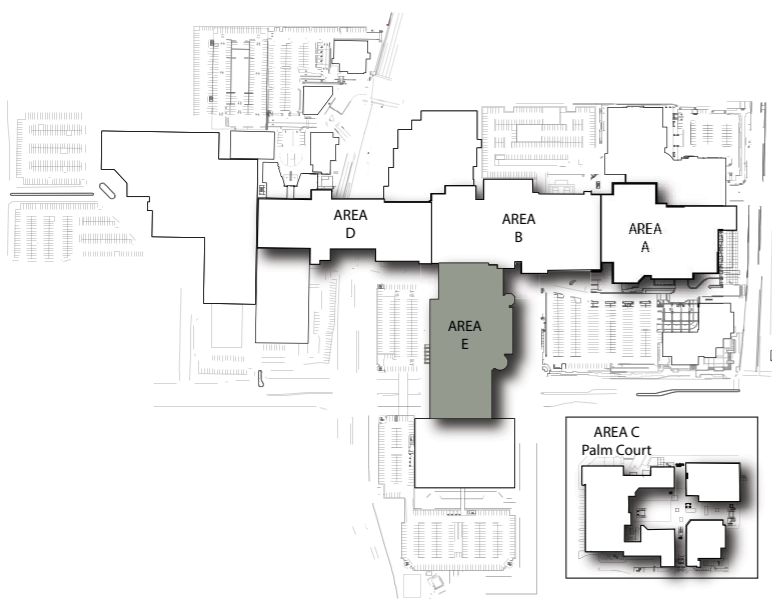

**AREA E
SECOND LEVEL**

STOREFRONT CONDITIONS

	TYPE A 12'-10" TENANT STOREFRONT TO INCLUDE 4" REVEAL
	TYPE B 17'-4" TENANT STOREFRONT TO INCLUDE 4" REVEAL
	TYPE C 13'-0" TENANT STOREFRONT TO INCLUDE 4" REVEAL
	TYPE D 12'-11" TENANT STOREFRONT TO INCLUDE 4" REVEAL
	TYPE E 15'-6" TENANT STOREFRONT TO INCLUDE 4" REVEAL
	TYPE F 10'-8" TENANT STOREFRONT TO INCLUDE 4" REVEAL

MALL ZONES > STOREFRONT CONDITIONS > AREA E

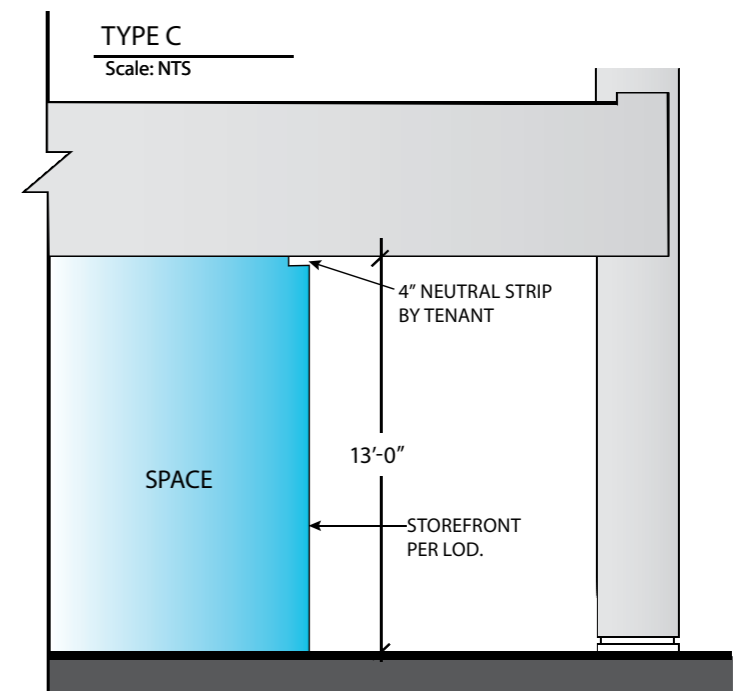
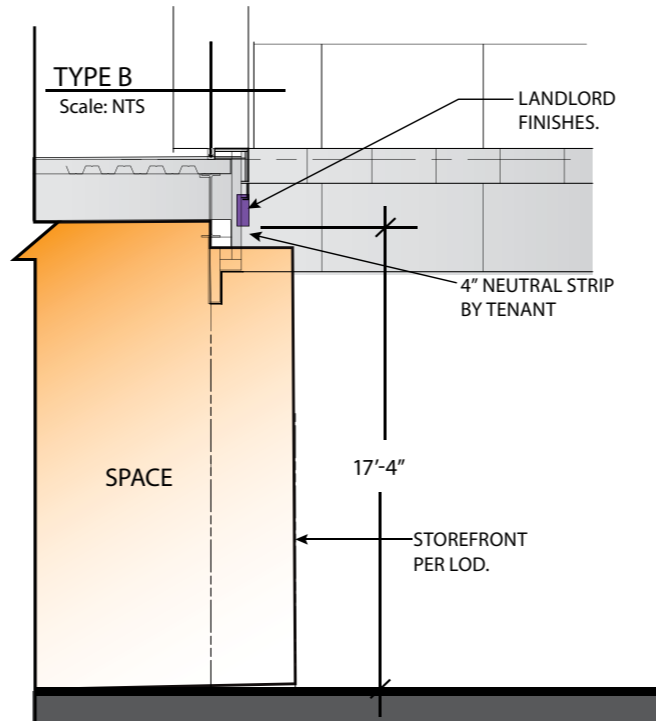
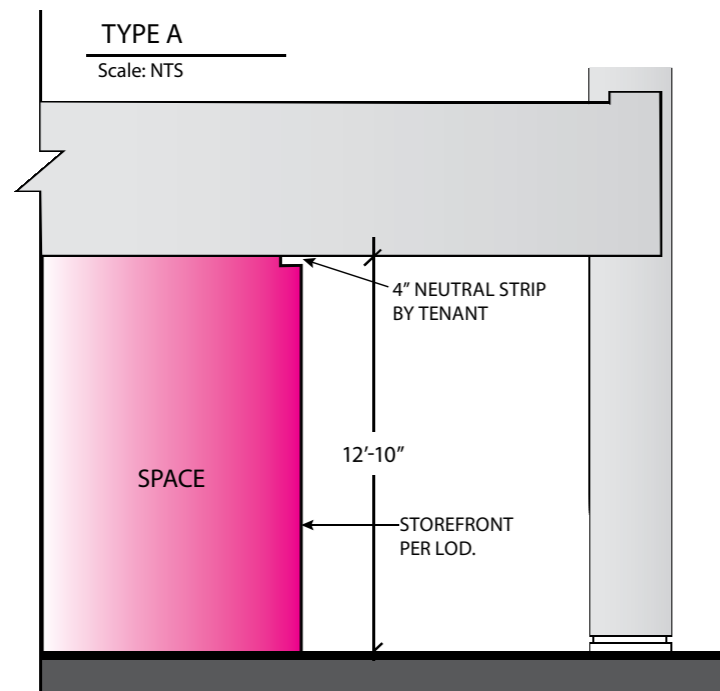
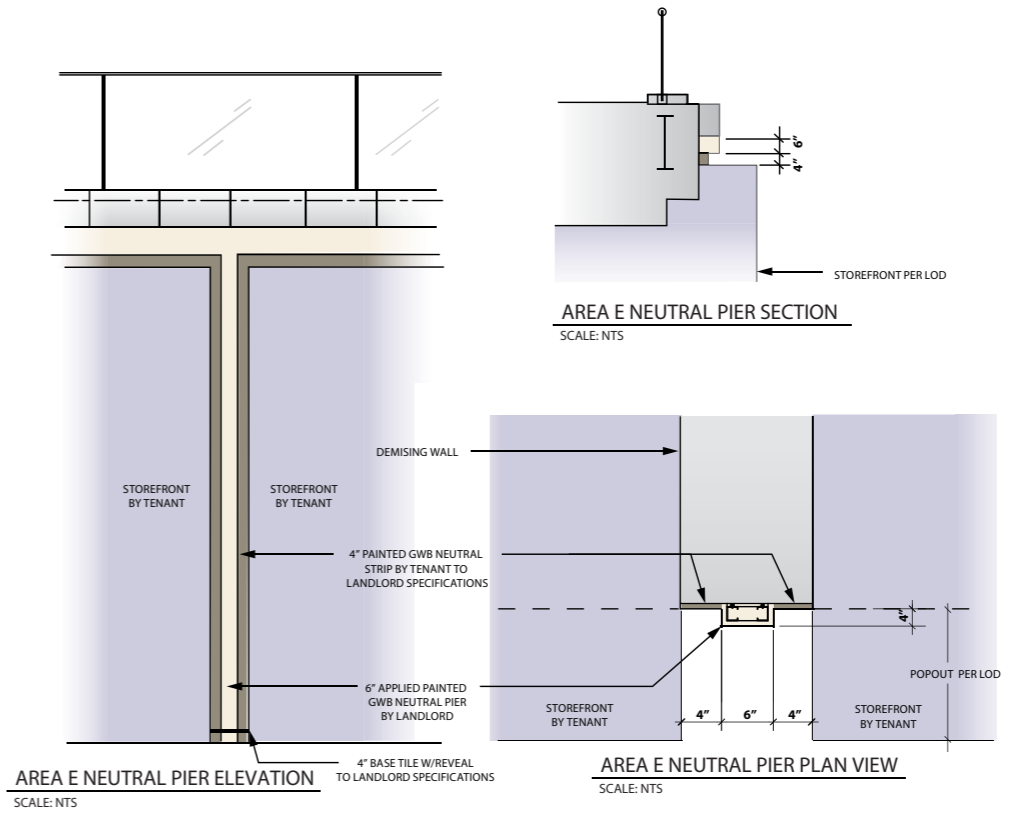
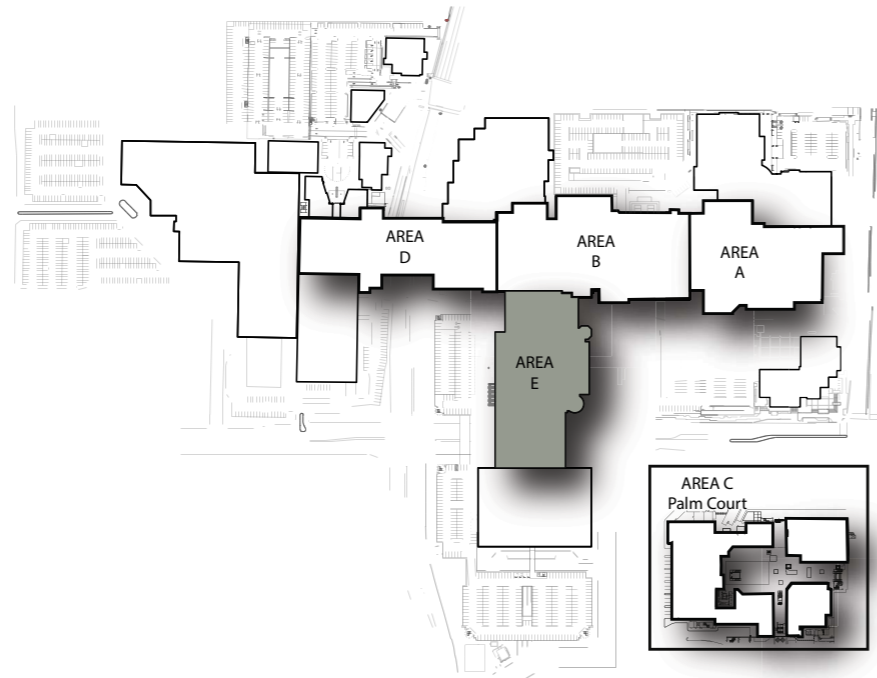

MALL ZONES > STOREFRONT CONDITIONS > AREA E

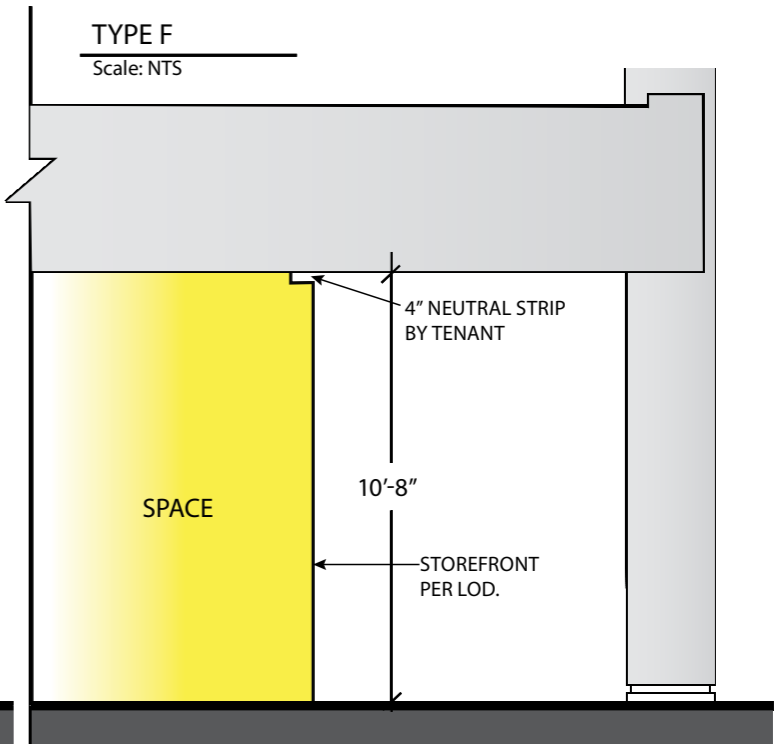
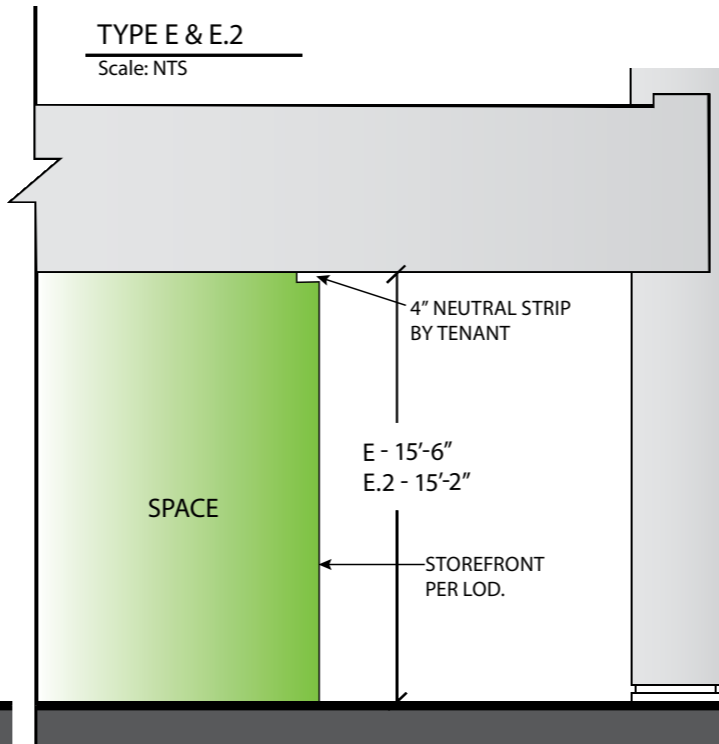
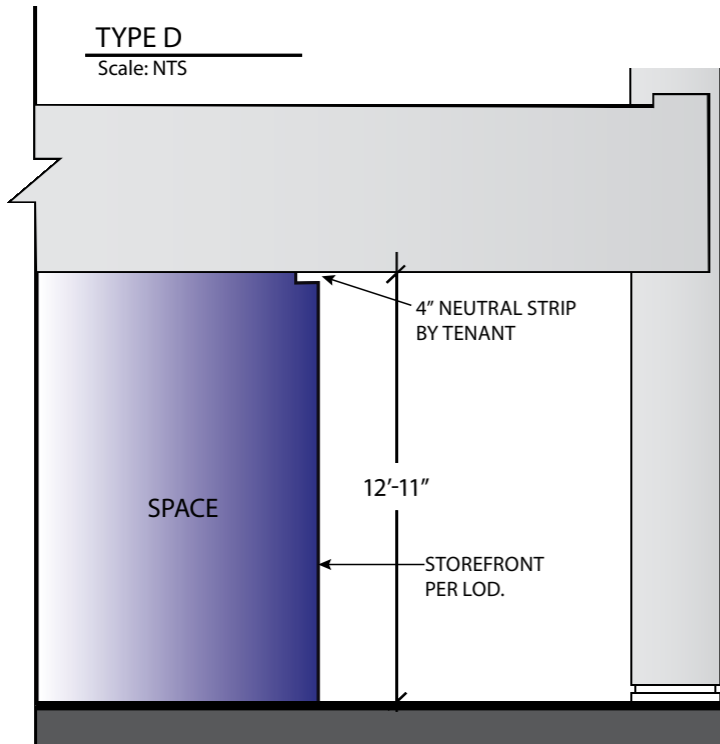
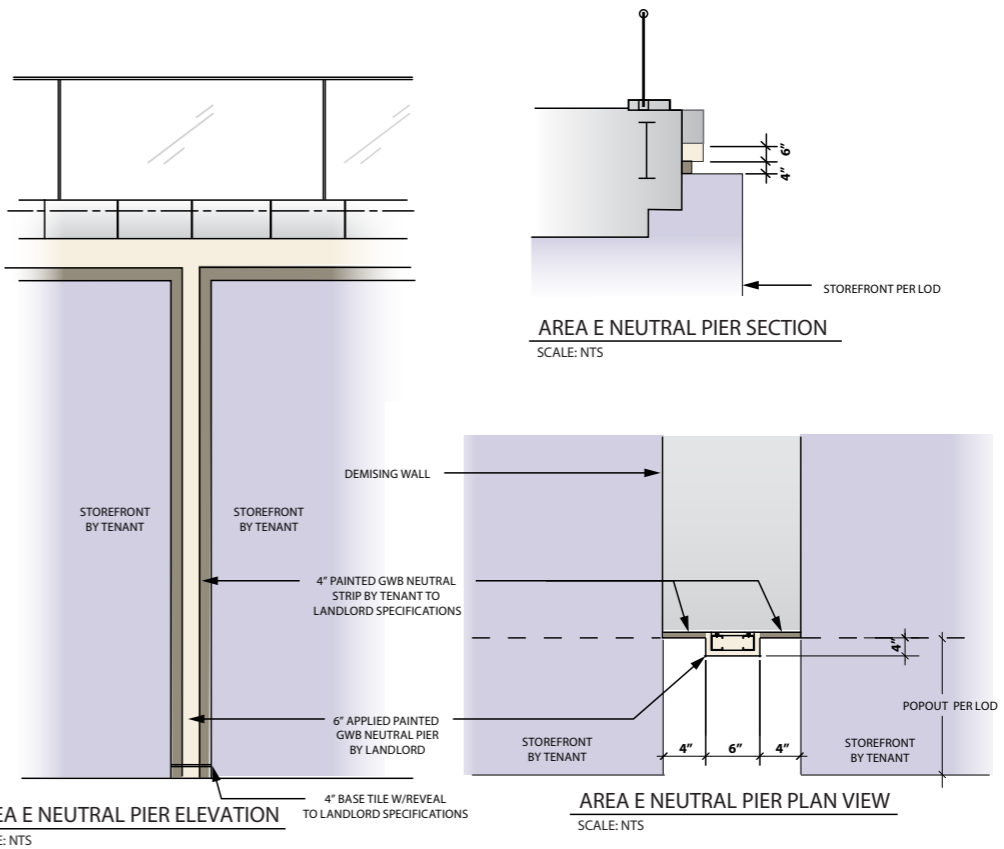
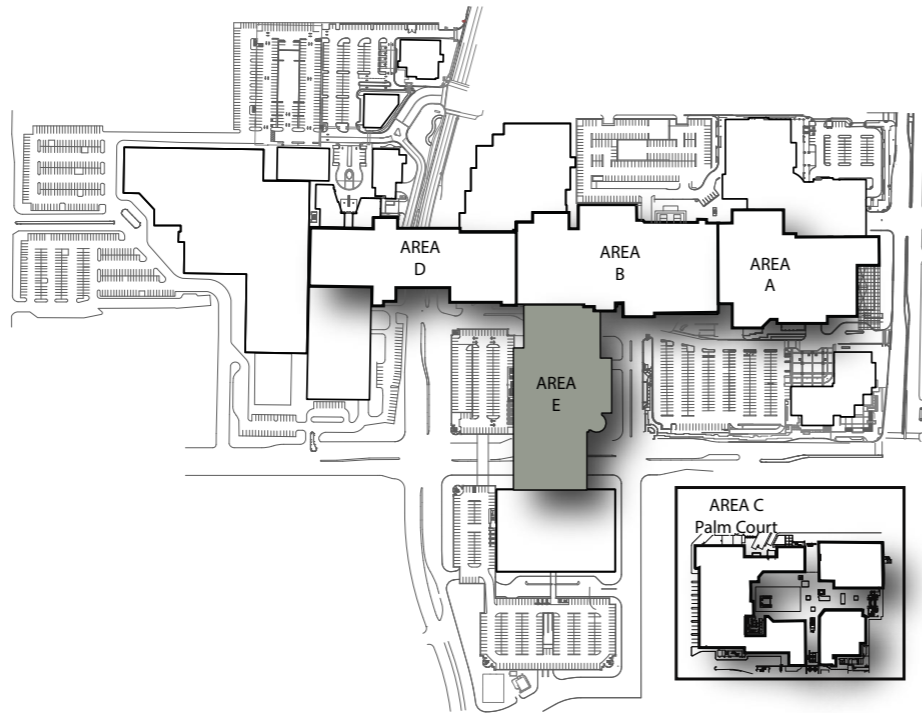

DESIGN INSPIRATION CONTENT OVERVIEW

4.1

VISUAL CONCEPTS

GUIDE TO DIFFERENT AESTHETIC CONCEPTS ENCOURAGING VIBRANT STORE DESIGNS.

4.2

KEY DESIGN ELEMENTS

OVERVIEW OF THE CORE DESIGN ELEMENTS TO EMBRACE WHEN CREATING AN ENLIVENING RETAIL EXPERIENCE.

The vibrant character of great shopping destinations is comprised of exceptional storefronts with texture, color, lighting, graphics and merchandising enlivening the pedestrian experience.

Tenants are encouraged to express their individuality and their brand identity through excellent design by forward thinking design teams.



VISUAL CONCEPTS > OVERVIEW

- ARTISAN
- URBAN
- WHIMSICAL
- INVITING
- ARTSY
- THEATRICAL

This section highlights six design concepts encouraged by Macerich for Tenants looking for additional inspiration. Our Design team welcomes Tenants to engage in these concepts and invites open collaboration in an effort to create store designs that enhance the retail experience.

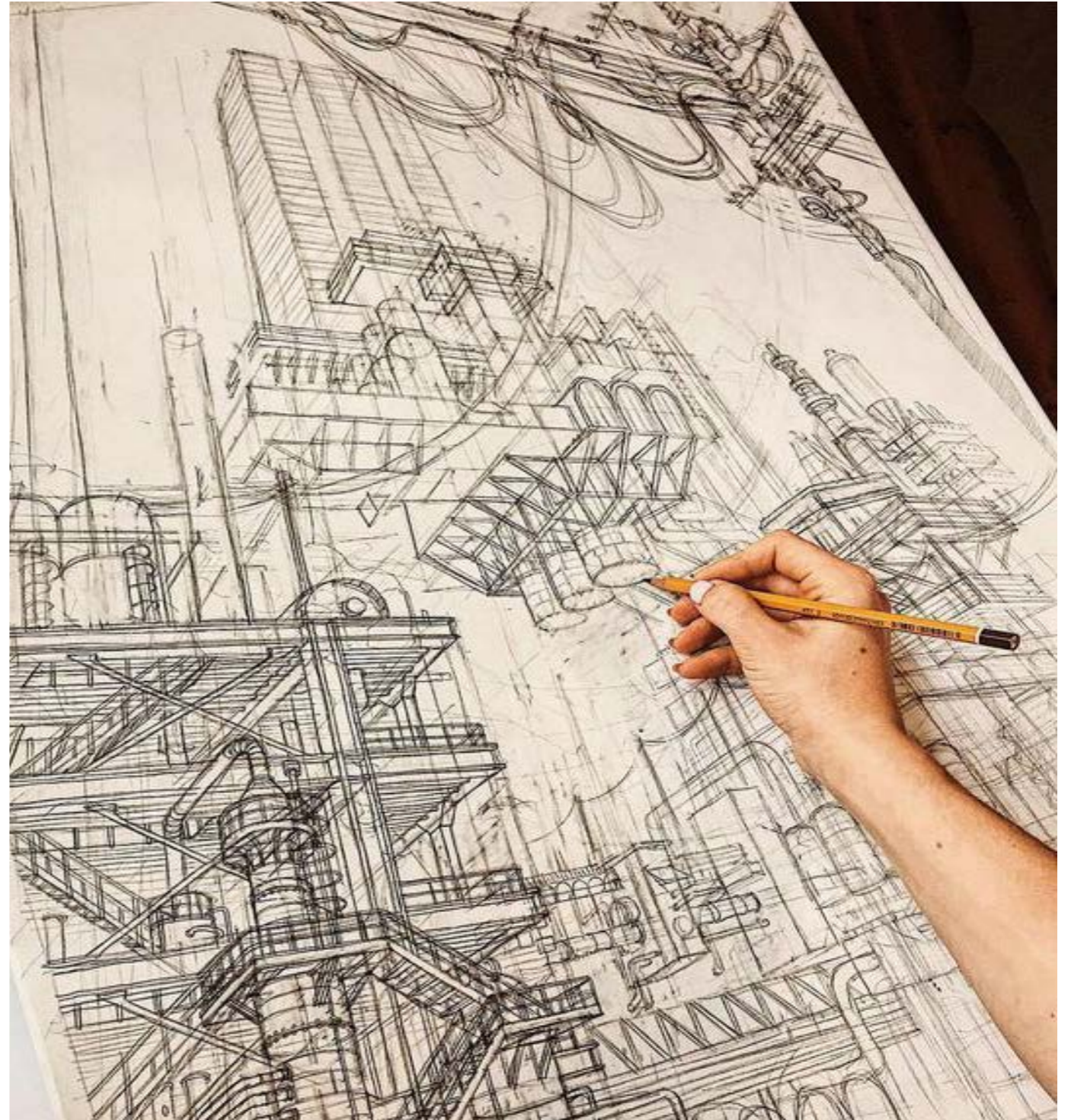

ARTISAN

NATURAL, SOPHISTICATED, UNIQUE



> URBAN

URBAN

EDGY, FUNKY, STREET SAVVY STYLE, INDUSTRIAL

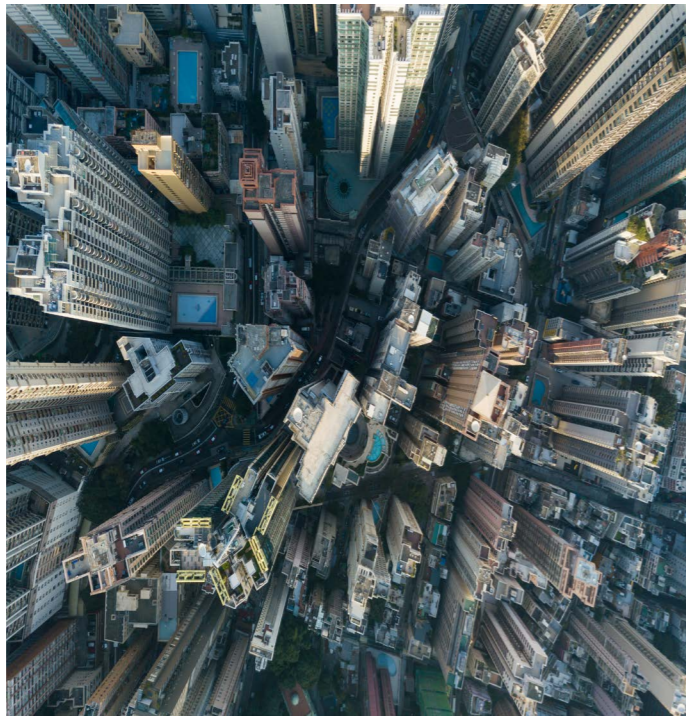

> WHIMSICAL

WHIMSICAL

UNEXPECTED, PLAYFUL, COLORFUL



> INVITING

INVITING
WARM, CALM, OPEN, SOFT



> ARTSY

ARTSY

QUIRKY, AVANT GARDE, SURPRISING



> THEATRICAL

T H E A T R I C A L
DRAMATIC, HIGH CONTRAST, MOVEMENT



KEY DESIGN ELEMENTS > BRANDING / VISUAL MERCHANDISING

Macerich embraces four key design elements to engage Customers and encourage Store traffic and sales. Strong use of textures, colors, lighting, graphics, and merchandising in these elements help draw Customers and invliven the pedestrian experience.

BRANDING

A brand is a name, term, design, symbol, color or some other feature that identifies a seller's product or services as distinct from those of other seller's.

Your branding can be communicated with signage, graphics, materials, shapes, colors, textures, patterns and the overall look and feel of your kiosk, to tell a story and create a lasting experience.



VISUAL MERCHANDISING

Strong visual presentation and merchandising are essential and integral components of retail design.

- Attempt to create triangular composition within style groups or color groups. (display in groups of three or five).
- Start with a center feature, (best sellers and hot items), and merchandise out symmetrically or asymmetrically in a balanced manner.



> LAYERING / TECH AND MEDIA

LAYERING

How can you make a wall / elevation into a canvas for communication to the Customer as they walk towards or by your store?

- Incorporating patterns and textures.
- Overlaying materials to create dimensionality.
- Molding shapes to create softness.
- Overlapping to create shadows and depth.



TECHNOLOGY AND MEDIA

Technology can enhance your online operation by transforming your retail space into a multifunctional one, that lends itself to being an in-store pick up location, payment booth or advertising billboard.

Integrating technology into your Store design can:

- Become an extension of you.
- Supplement your salesforce with interactive screens for ordering, self-design functions and more.
- Keep your business connected with your customer.
- Help you tell a story.
- Help make menu boards easier to update and better communicate your offerings to your Customer via LCD screen loops.

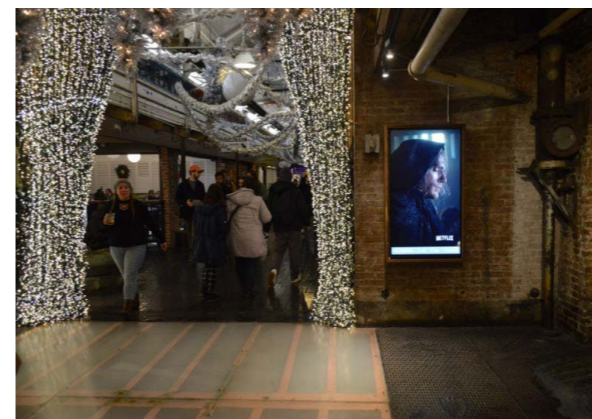

PROPERTY INFO CONTENT OVERVIEW

5.1 ADDRESS & HOURS

LOCATION AND SCHEDULE INFORMATION.

5.2 SITE PLAN

OVERVIEW MAP OF CENTER.

5.3 CONTACTS

MALL CONTACTS, REQUIRED CONTRACTORS, LOCAL MUNICIPALITIES, AND UTILITY CONTACT INFO.

5.4 CODES AND PERMITTING

OVERVIEW OF BUILDING CODE, CLASSIFICATIONS, AND LOCAL PERMITTING.

5.5 OPERATIONS AND UTILITIES

OVERVIEW OF CENTER OPERATIONS AND TYPICALLY AVAILABLE UTILITIES.

5.6 CONSTRUCTION

OVERVIEW OF CONSTRUCTION PROCEDURES.

SECTIONS OF INTEREST

The following sections provide additional details and requirements related to this Criteria:

ADDENDUM

Provides additional construction requirements to contractors.

The Property Info Criteria provides an overview of the Center's building classification, contacts, local permitting, and typically provided utilities.

It is important to note that the Contacts section includes the Center's required contractors. These contractors **must** be used during the design and buildout of your Store.

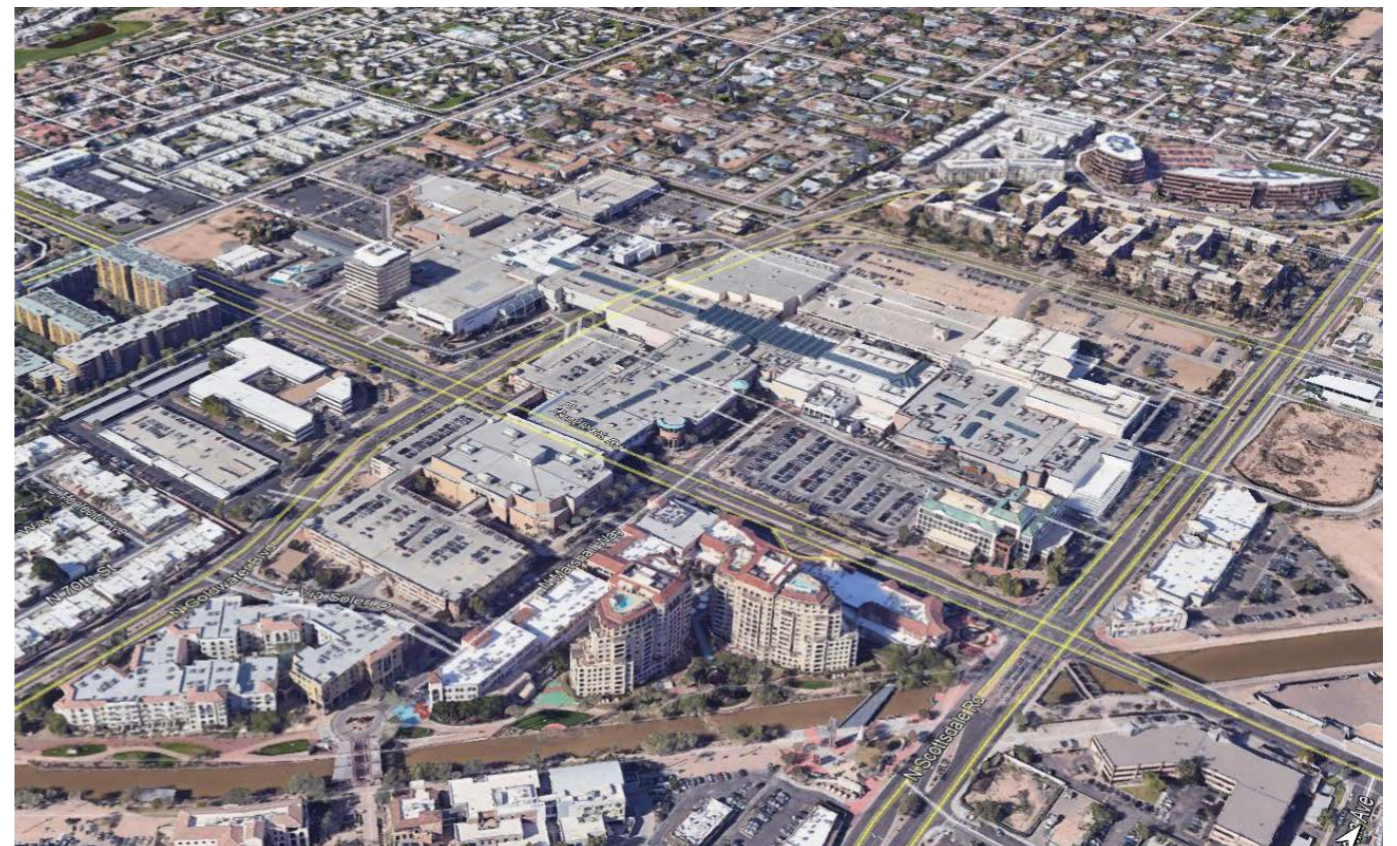

ADDRESS & HOURS

Scottsdale Fashion Square is located at the intersection of Scottsdale Road and Camelback Road, in Old Town Scottsdale. The Center is open 7 days a week. Open hours for individual restaurants and entertainment venues may vary.

Center Address

7014 E Camelback Road
Scottsdale, AZ 85251
(480) 941-2140 Phone

Center Hours

Monday - Saturday: 10:00 AM to 9:00 PM
Sunday: 11:00 AM to 6:00 PM

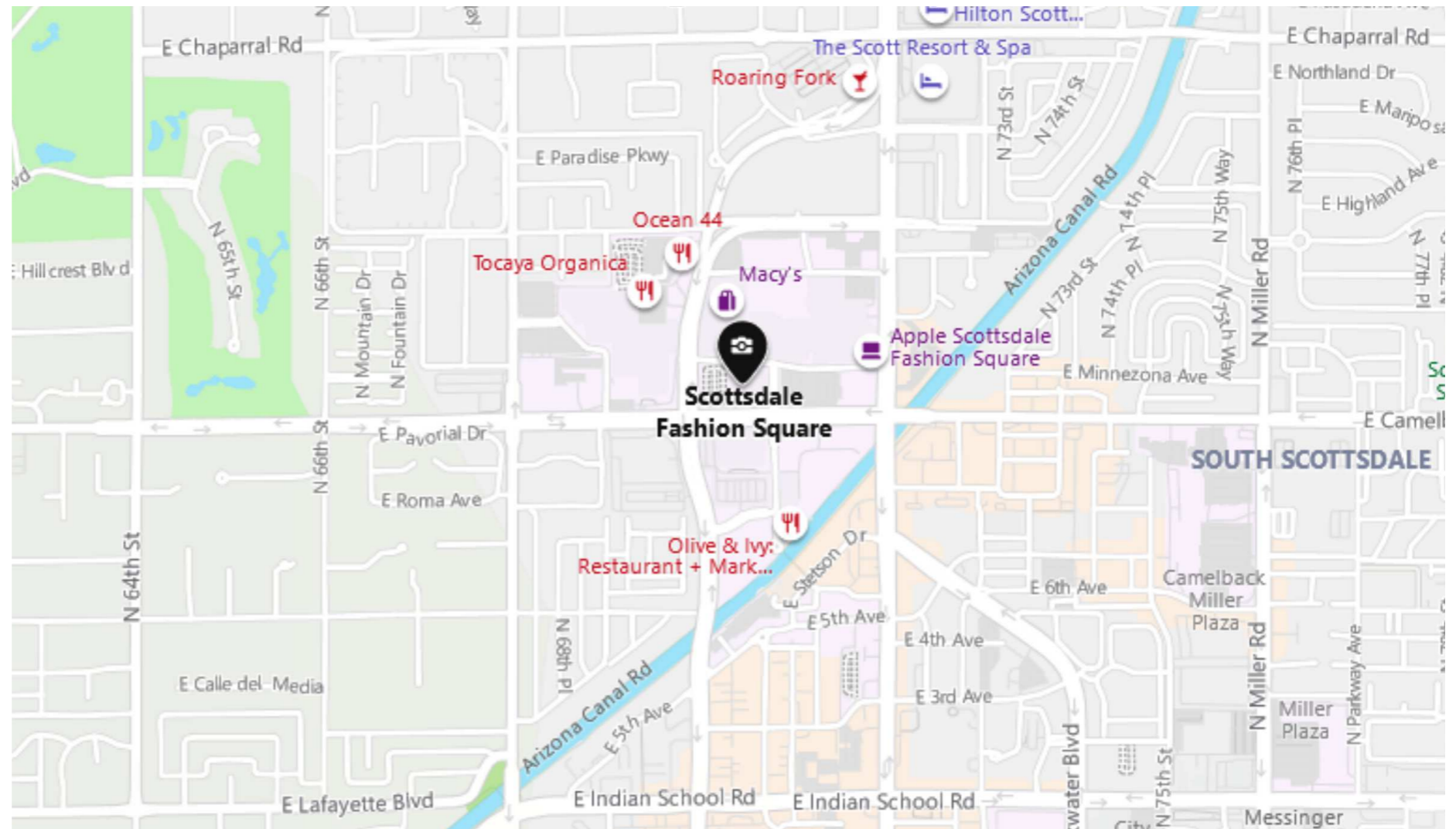

SITE PLAN

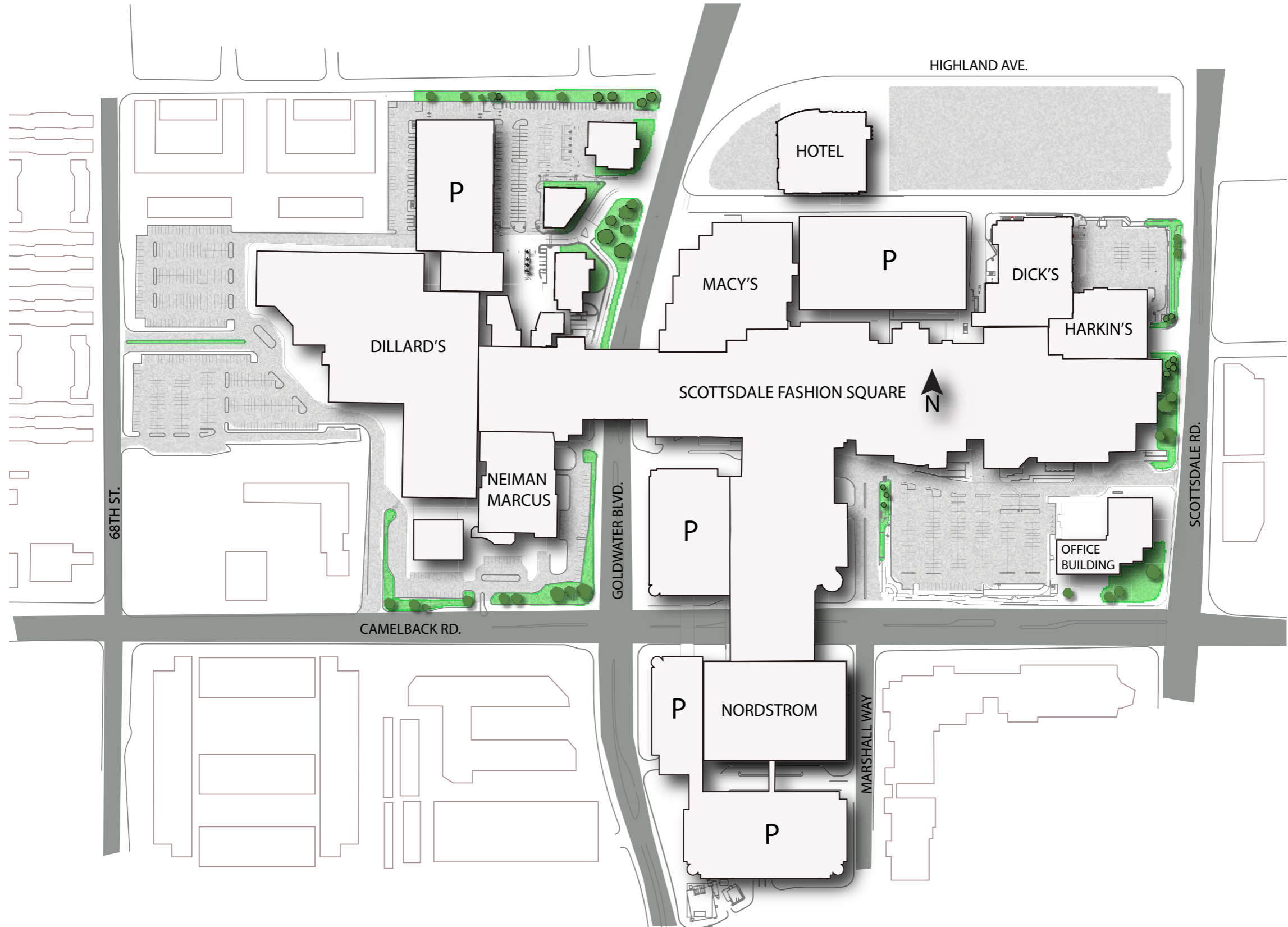

CONTACTS > PROPERTY TEAM / REQUIRED CONTRACTORS

PROPERTY TEAM

The following points of contacts are available to discuss site details and procedures. The primary point of contact for inquiries is the Tenant Coordinator.

PROPERTY MANAGER

David Hyatt
Phone: (480) 945-5495
David.Hyatt@macerich.com

ASSISTANT PROPERTY MANAGER

Rosi Pleitez
(480) 945-5495 x132
rosie.pleitez@macerich.com

OPERATIONS MANAGER

Mark Pond
(480) 945-5495 x106
mark.pond@macerich.com

ASSISTANT OPERATIONS MANAGER

Stacy Skowronski
(480) 945-5495
stacy.skowronski@macerich.com

SECURITY DISPATCH

(480) 949-0606

TENANT COORDINATION

Will Ryczek
Phone: (602) 953-6222
will.ryczek@macerich.com

Natasha Brickner
Phone: (602) 953-6216
natasha.brickner@macerich.com

LEASING

Cameron Done
Phone: (602) 953-6466
cameron.done@macerich.com

LANDLORD/OWNER

The MACERICH Company
401 Wilshire Blvd., Suite 700
Santa Monica, CA 90401

REQUIRED CONTRACTORS

The following points of contacts are the required contractors that must perform the construction for their related field and/or systems. These contractors are required since they have intimate knowledge of the property building systems and can properly interface Tenant systems with the base building infrastructure.

CONTROLS CONTRACTOR

Koro-CTS
Loren Waxman
(623) 522-7381
Loren.waxman@korolv.com

FIRE ALARM PANEL PROGRAMMING

JCI
Jeff Crowder
(602) 571-0898
jeffrey.crowder@jci.com

FIRE PROTECTION

Contractor Fire Protection
Ed Bergsbaken
(480) 539-3323
ed@azcfp.com

ELECTRICAL ROOM

Rehco Electric
Shaun Harris
(602) 316-7875
seharriselect@gmail.com

TAP IN TO MALL CHILLED WATER LINES

AZ Tap Masters
Don Hardin
(623) 776-3132
azhottaps@gmail.com

REFURBISH RE-USED FAN COIL UNITS

Mechanical Air Design
Dave Mure
(480) 483-9622
mad.inc@att.net

TAP IN TO LL TRUNK LINE FOR VAV BOXES IN EAST WING

Mechanical Air Design
Dave Mure
(480) 483-9622
mad.inc@att.net

HVAC (ADDL INFO)

Contact Scottsdale Fashion Square's HVAC Department
(480) 990-7502 Phone

ROOFING

Progressive Roofing
Mark Farrell
(602) 278-4900 Phone

ROOFING-PHASE 10 ONLY

Classic Roofing
Andy Clark
(602) 442-5550 Phone

VOICE / DATA SERVICE

Penny Sexton
REIT Relations Manager
(629) 247-3141
psexton@granitenet.com

LOW VOLTAGE

Noah Irving
Manager of GRID Operations
****It is highly recommended to coordinate service install a minimum of 4 weeks in advance.**
(617) 804-2015
nirving@granitenet.com

PREFERRED BARRICADE VENDOR

Terri Hopkins
thopkins@bostonrs.com
Boston Retail Solutions
28441 Felix Valdez Ave
Temecula, CA 92590

CONTACTS > UTILITIES / LOCAL AGENCIES

UTILITIES

The following points of contact are required to set up utility accounts:

ELECTRIC

SRP
1521 N. Project Dr.
Tempe, AZ 85281
(602) 236-8833 Phone

GAS

Southwest Gas Company
10851 N. Black Canyon Hwy.
Phoenix, AZ 85029
(602) 861-1999 Phone

LOCAL AGENCIES

The following points of contacts are the local agencies responsible for plan reviews and inspections:

HEALTH DEPARTMENT:

Maricopa County Department of Public Health
4041 N Central Avenue
Suite 1400
Phoenix, AZ 85012
(602) 506-6900 Phone
(602) 506-6885 Fax

BUILDING AND SAFETY:

City Scottsdale Planning and Community Development
7447 Indian School Road, Suite 105
(480) 312-2500 Phone
(480) 312-7088 Fax

FIRE DEPARTMENT:

City of Scottsdale Fire Dept.
8401 E. Indian School Rd.
Scottsdale, AZ 85251
(480) 312-1855 Phone

BUSINESS LICENSING:

City of Scottsdale
(480) 312-2500 Phone

LIQUOR LICENSING:

City of Scottsdale
(480) 312-2500 Phone

ENGINEERS OF RECORD:

STRUCTURAL ENGINEER

A.V. Schwan & Assoc., Inc.
6000 E. Thomas Rd. Ste. 1
Scottsdale, AZ 85251
Stephen Schwan
(602) 265-4331 Phone
(480) 662-1788 Fax
SSchwanpe@avschwan.com

ELECTRICAL ENGINEER

Sparling
111 SW 5th Ave, Suite 1575
Portland, OR 97204
(503) 273-0600 Phone

PLUMBING ENGINEER

R&S Plumbing
Rob Dockall
(623) 535-1044 Phone

Rainforest Plumbing Works

Aimee Guidali
(480) 615-7766 Phone

PM Plumbing

Leon Black
(480) 844-2892 Phone

ARCHITECT (BASE BUILDING)

Sixty-First Place Architects
(480) 947-6844

Wilkes Architecture
(602) 339-4247 Phone

Callison, LLC
1420 Fifth Ave, Suite 2400
Seattle, WA 98101
(206) 623-4646

CODES AND PERMITTING

BUILDING CODE OVERVIEW

Scottsdale Fashion Square offers spaces for retail, restaurants, and entertainment. Below are the pertinent property details related to local building codes. It is the sole responsibility of the Tenant's Architect, Engineers, Consultants, and Contractors to comply with all applicable federal, state, and local codes and ordinances for their occupancy type.

BUILDING TYPE:

Single level regional shopping center of approximately 1,840,182 square feet of Gross Leasable Area.

OCCUPANCY TYPE:

Mercantile

CLASSIFICATION:

Covered center building type II construction, mercantile, with business, storage.

BUILDING CODE INFORMATION:

The following is a general reference list of applicable codes. It is the sole responsibility of the Tenant's Architect, Engineer(s) and Contractor(s) to comply with all applicable federal, state, local codes and ordinances for their occupancy type.

APPLICABLE CODES:

2006 IBC, IMC, IPC, IFC, IECC

2005 NEC

CITY OF SCOTTSDALE - PERMITTING

Short Scope Review "SSR" is a process the City has created within their One Stop Shop to expedite permit reviews for projects that meet the following criteria:

- Around 2,500sf of mostly open retail space (may be larger if the below criteria remains)
- Does NOT include structural work
- Is a B or M occupancy classification
- Is interior work (no exterior projects)

By indicating "SSR" on a tenant's permit application, in the project name section, a Tenant can utilize this process. There is a 3-4 day administrative time period for the collection of paperwork and assigning of reviewers, then a subsequent 7-business day review period, concurrently by all departments. At the end of the 7-day period, either comments or approval will be issued and emailed to the applicant, with instructions on next steps.

Please use this link to get more information on the City of Scottsdale's One Stop Shop.

<https://www.scottsdaleaz.gov/planning-development/one-stop-shop#:~:text=Small%20scope%20reviews%20must%20be,them%20as%20quickly%20as%20possible.>

CONDITION OF PREMISES

Upon the Delivery Date, Tenant shall accept delivery of the premises in an “As Is” condition and “With All Faults” and Landlord shall have no obligation to improve, remodel, alter or otherwise modify or prepare the premises for Tenant’s occupancy except to the extent otherwise expressly stated in the Lease Documents. Tenant hereby represents each of the following:

1. Tenant or its authorized representative has inspected the premises and has made all inquiries, tests and studies that it deems necessary in connection with its leasing of the premises.
2. Tenant is relying solely on Tenant’s own inspection, inquiries, tests and studies conducted in connection with and Tenant’s own judgment with respect to, the condition of the premises and Tenant’s leasing thereof.
3. Tenant is leasing the premises without any representations or warranties, express, implied or statutory by Landlord, Landlord’s agents, brokers, finders, consultants, counsel, employees, officers, directors, shareholders, partners, trustees or beneficiaries.
4. The Work to be completed by Landlord, “Landlord’s Work” under the Tenant Lease shall be limited to that described in the foregoing sections.
5. All other items of work not provided for herein, to be completed by Landlord, shall be provided by the Tenant at Tenant’s expense and is herein referred to as “Tenant’s Work”.

FIELD CONDITIONS

1. Tenant is required to inspect, verify and coordinate all field conditions pertaining to the premises from the time prior to the start of its store design work and the commencement of its construction. Any adjustments to the work arising from field conditions not apparent on drawings and other building documents shall receive written approval of Landlord prior to start of construction.
2. Immediately following the installation by Landlord of metal stud framing defining the premises, the Tenant shall verify the accuracy of said installation and shall immediately advise Landlord of any discrepancies. Failure to so notify Landlord shall be deemed as acceptance by Tenant of said installation and layout.
3. Landlord shall have the right to locate, both vertically and horizontally, utility lines, air ducts, flues, drains, clean outs, sprinkler mains and valves, and such other equipment including access panels for same, within the premises.
4. Landlord’s right to locate equipment within the premises shall include the equipment required by other Tenants. Landlord shall also have the right to locate mechanical and other equipment on the roof over the premises.

CONSTRUCTION > PRE-CONSTRUCTION / CLOSE OUT

a tenant build outs:

WORKING HOURS

The working hours for all Tenant Contractors are from 7:00 AM to 3:30 PM Monday thru Friday with regulatory breaks in between. Any work outside the above hours must be approved in writing by the Center management. The Tenant Contractor shall be liable to make any arrangements and bear all costs and expenses associated with having other tradespersons present or available while work is carried out.

PRE-CONSTRUCTION

Prior to any construction commencement, the contractor's site superintendent is required to meet with the Landlord to review property construction requirements, submit construction documentation, and provide payment for property construction fees.

Required pre-construction documents include:

- Landlord Approved Construction Drawings
- Contractors Rules & Regulations to be completed and signed in full
- Approved GC Certificate of Insurance
- A copy of the Building Permit issued by the City
- General Contractor's state license
- Construction Progress Schedule
- Subcontractor List (include associated trade, contact name and phone number)

The Landlord will send a Preparedness Letter detailing the fees required for collection prior to scheduling this pre-construction meeting.

[CONTRACTOR RULES AND REGULATIONS](#) are linked in the [ADDENDUM](#).

CLOSE OUT

At construction completion, the Landlord will meet with the superintendent to perform a punch list walkthrough. The created punch list is required to be completed to the Landlord's satisfaction in order to close out the construction project. All construction charges must be paid in full. A reference [PUNCH LIST](#) is linked in the [ADDENDUM](#).

To complete closeout, the following documents are required to be submitted:

- Copy of Certificate of Occupancy or equivalent and Proof of Passing Final Inspections.
- Final list of Subcontractors (please make any changes or additions from the list supplied at pre-con)
- Unconditional Lien Waivers from all contractors, subcontractors and materials and service suppliers.
- Notarized Affidavit from General Contractor stating that no liens exist as a result of Tenant's work.
- Notarized AIA documents G702 & G703 (if the job is \$100,000.00 or more) / General Contractors Final Billing
- AABC Certified Air Balance Report
- As-Built Documents (record set of what was constructed at the site, including Architectural, Structural, Mechanical, Plumbing, Electrical, Fire Protection, etc.) Electronic (PDF) format preferred.

SUBMITTAL CRITERIA CONTENT OVERVIEW

6.1

CONSTRUCTION DOCUMENTS

SUBMITTAL REQUIREMENTS FOR ARCHITECTURAL AND TECHNICAL DESIGN DOCUMENTS.

6.2

SIGNAGE DRAWINGS

SUBMITTAL REQUIREMENTS FOR PRIMARY AND SECONDARY STOREFRONT SIGN DESIGNS.

The Submittals Criteria highlights the Landlord review process and drawing submittal requirements to ensure a quick and smooth drawing review for your design and construction drawings.

Tenant construction and signage drawings must be reviewed and Approved by the Landlord before the drawings can be submitted for permit. Permits from the local Municipality are required for all incoming Tenant construction and signage.

It is always the Tenant's responsibility to ensure:

- Compliance with the Lease document.
- Field verification of conditions and dimensions.
- Discrepancies between the drawings and the as-build conditions.
- Coordination with trades to ensure compliance with all local and national codes.

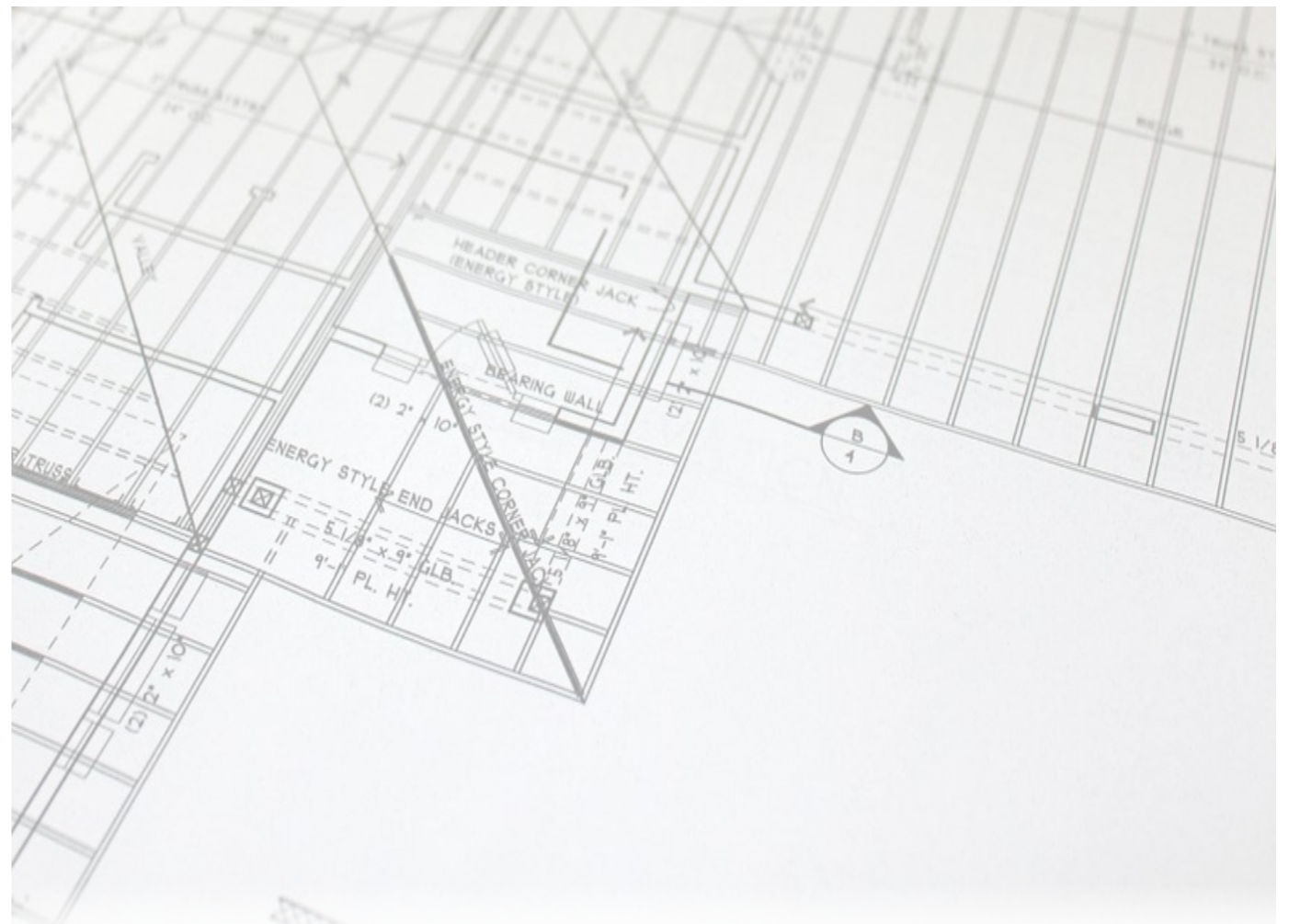

DRAWING REVIEW PROCESS

Drawing reviews are required to be submitted in two stages for Landlord review; Preliminary and final Construction Drawings. Preliminary drawings are required to ensure the design process moves quickly by ensuring that all Criteria requirements are understood and adopted early in the design. This helps ensure an expedited review of the final Construction Drawings.

REVIEW TIMELINE

Step	Action	Time Period
1	Tenant submits preliminary design.	Required 20 days after Lease Execution or 10 days following previous submittal disapproval.
2	Landlord Approved Preliminary Design.	15 days after confirmed completion of Step #1.
3	Tenant submits final construction drawings.	Required 20 days after Tenant Coordinator approval at Step #2.
4	Landlord Approves final documents.	15 days after completion of Step #3.
5	Tenant submits drawings for permit. (If applicable)	5 days after confirmed completion of Step #4.
6	Tenant responds to any requests from or comments by permitting jurisdiction.	5 days.
7	Upon permit review approval, Tenant pays all fees and logs out permit.	5 days.

> SUBMITTAL REQUIREMENTS > PRELIMINARY

PRELIMINARY DESIGN SUBMITTAL

The Preliminary Document review process will evaluate all the criteria discussed in this manual, including overall three-dimensional form, degree of design uniqueness and identity, use and detailing of materials, colors and lighting, and integration of signage and graphics.

Submittals are to provide the reviewer with a clear understanding of proposed design concepts.

The submission must be complete in order to fairly evaluate the proposal and prevent continuation of work on an unacceptable design.

Tenant shall submit to Landlord at tcphoenix@macerich.com an electronic PDF files of the following:

- **Color and Material Sample Board**
Include actual samples of all Tenant colors and materials visible to the public, on a digital sample board. Clearly label all materials and reference to floor plan elevations.
- **Perspective and/or Photo Image(s)**
Colored perspective rendering and/or prototypical photo images of the proposed storefront, including graphics and signage.
- **Cover Sheet**
Include: Name of Tenant, name of Mall or Center, space number, Applicable Codes, Building Type and Occupancy Type, Leased square footage, and Key Plan
- **Floor Plan**
¼" Scale Minimum showing: Entire lease dimensioned space with room names, floor finishes, casework and fixture locations.
- **Reflected Ceiling Plan**
¼" Scale Minimum showing: Lighting design, including fixture types and locations, signage, access panels, Overhead projections such as light coves and fascia systems, and Entrance.
- **Sections**
1" Scale Minimum showing: Entry, Display windows and fascia, Sign integration into storefront design.
- **Storefront Elevations**
½ Scale Minimum showing: Exterior views - front and sides, Signs, graphics, logos.

Copies of all drawings are to be sent to the Tenant Coordinator via email.

A physical sample board is also required, mounted on foam core or card stock to be sent in coordination with your Tenant Coordinator.

> SUBMITTAL REQUIREMENTS > FINAL

FINAL DRAWING SUBMITTAL

After Preliminary Drawing Approval, it is critical to quickly complete and submit Final Construction Drawings for Landlord review.

If any questions arise from the Tenant's interpretation of the design and criteria information, the Tenant shall assume all responsibility for clarification by written request to the Tenant Coordinator. The Landlord plan review and approval process is independent of local permitting for construction. The Tenant is responsible for procurement and compliance with local, state and federal codes and requirements.

Tenant shall submit to Landlord at tcphoenix@macerich.com an electronic PDF files of the following:

- **Responsibility Schedule**
Any work, which is the Landlord's responsibility, must be listed clearly on a responsibility schedule on the cover sheet.
- **Cover sheet**
Include a Key Plan, Name of Tenant, name of Mall or Center, space number and location leased premises within Mall or Center, Applicable codes, building type and occupancy type, Leased square footage, Responsibility schedule, and Drawing index.
- **Floor Plans**
¼" Scale Minimum showing: Entire lease space with room names, Floor finishes, casework and fixture locations, and Demolition plan.
- **Reflected Ceiling Plan**
¼" Scale Minimum showing: Complete lighting design, including fixture types and locations, signage, access panels, Overhead projections such as light coves and fascia system, Entry, Connection to Landlord's work, Tenant's framing and/or additional structure showing freestanding from Landlord's structure.
- **Sections**
1" Scale Minimum showing: Entry, Display windows and fascia, Sign integration into storefront design, Connection to Landlord's work, Tenant's framing and/or additional structure showing freestanding from Landlord's structure.
- **Interior Elevations**
¼" Scale Minimum showing: All sales floor interior views, Built-in casework, signage, and display systems.
- **Storefront Elevations**
½" Scale Minimum showing: Exterior views - front and sides, Signs, graphics, logos, Landlord neutral piers, Storefront finishes (to be referenced to finish schedule)
- **Architectural Details**
½" Scale Minimum.
- **Door Schedule**
Include floor transition details and anti-theft security system details.
- **Details, Catalogue Cut Sheets, and Fixture Finishes**
- **Finish & Color Schedule**
- **Include CAD/DWG drawing files as part of drawing submission including: Demo plan, Floor plan, MEP plans, and Life safety/ Egress Plans. Please include any background drawings that are necessary to view these files as a comprehensive whole.**

Copies of all drawings are to be sent to the Tenant Coordinator via email.

> SUBMITTAL REQUIREMENTS > FINAL ENGINEERING

FINAL DRAWING SUBMITTAL - ENGINEERING DRAWINGS

The Landlord does not review for mechanical, electrical, plumbing, or structural design, nor does the Landlord accept responsibility for the Tenant's adherence to governing codes.

Tenant shall submit to Landlord at tcphoenix@macerich.com an electronic PDF files of the following engineering drawings included in the final drawing set:

I. MECHANICAL DESIGN DOCUMENTS

- Make, type, and performance of all equipment.
- Sign and seal by a Licensed Engineer in the state where the Shopping Center is located.
- Calculations showing the heating and cooling required, including transmission and ventilation losses in the space, and heat and cooling provided for the ventilation supply, and exhaust required for the space. Calculations must be performed in accordance with the latest ASHRAE standards and tabulated in a concise, orderly manner.
- Temperature control system data showing make, control, and energy management systems.
- Exhaust system layout including CFM and equipment specifications.
- Reflected ceiling plan showing HVAC equipment.
- Roof plan with equipment locations.
- Structural details for support of all rooftop equipment and equipment suspended from the steel structure.

II. PLUMBING DESIGN DOCUMENTS

- Make, type, and performance of all equipment.
- Sign and seal by a Licensed Engineer in the state where the Shopping Center is located.
- Complete plumbing system design and floor plan for the Tenant space including, but not limited to the toilets, sinks, urinals, drains, hot water heaters, water coolers, grease trap/interceptors and connections into existing water and sewer lines.
- Single line diagram.
- Fixture schedule.
- Water heater detail as applicable.
- Grease trap cut sheets as applicable.

III. FIRE PROTECTION / SMOKE EVACUATION DESIGN DOCUMENTS

- Reflected ceiling plan, with revised sprinkler head locations.
- Design must be City approved before construction

IV. ELECTRIC DESIGN DOCUMENTS

- Sign and seal by a Licensed Engineer in the state where the Shopping Center is located.
- Panel schedules, load calculations, and meter information, if applicable.
- Structural drawings for all equipment that will be suspended from the steel structure.
- Electrical load summary and Title 24 Energy Calculations (for State of California).
- Floor plan depicting equipment locations and branch circuitry.
- Reflected ceiling plan depicting the layout of light fixtures.
- System one line diagrams.
- Lighting fixture schedule.
- Equipment legend.

V. STRUCTURAL DESIGN DOCUMENTS

- Design elements affecting the structure of the base building.
- Alterations, additions, modifications and reinforcements to the base building which shall be required to accommodate Tenant's Work.
- All calculations & details (Include ICBO numbers on all framing details, Seismic bracing details for State of California.)
- All forms required by governmental agencies and Governmental Regulations, fully and properly completed and executed by Tenant.
- Partial structural framing plan showing existing conditions for new and existing rooftop installations and proposed reinforcement, which shall be accompanied by structural engineers' calculations, drawn on a scale of 1/2"=1'0".
- Ceiling, soffits, storefront attachment details to existing base building.
- A letter from a state-registered structural engineer certifying that all new equipment and design elements serving the Premises are adequately supported to carry the new load.

ADDENDUM LINKS

This Addendum contains links to supplemental documents of specific requirements and information. These documents are considered part of the Tenant Criteria Package. Clicking the links below will navigate to the described documents. It is the responsibility of the Tenant, its contractors, subcontractors, architects, engineers, employees, and agents to comply with terms of the Tenant Criteria, Addendum included.

GLOSSARY

I. [GLOSSARY OF TERMS](#)

Defines commonly used terms for clarity.

DESIGN ADDENDUM

I. [MACERICH SUSTAINABILITY HANDBOOK](#)

Guide to encourage energy efficient, sustainable design.

II. [UNIT UTILITIES AS BUILT CHECK LIST](#)

Helpful checklist for reference during a site survey.

III. [SPECIALTY LEASING CRITERIA](#)

Design requirements for temporary Tenant's buildout and signage.

BARRICADE ADDENDUM

I. [BARRICADE GUIDELINES](#)

Guide to installing and activating construction barricades with graphics.

CONSTRUCTION ADDENDUM

I. [CONTRACTOR RULES AND REGULATIONS](#)

Document detailing the rules and regulations Tenant contractors must adhere to during their construction. This document must be reviewed and signed by the Site Superintendent overseeing the Tenant build out.

II. [HOT WORK PERMIT](#)

Required form to submit when construction required hot work.

III. [PUNCH LIST](#)

Reference Landlord Punchlist that that Landlord will use to inspect and confirm completion of Tenant construction.