



LOS CERRITOS
CENTER

TENANT CRITERIA

MACERICH®

VISION STATEMENT

Welcome to Los Cerritos Center.

It is our vision and mission at Macerich to distinguish ourselves through superior performance in retail development and continuous improvement of our portfolio, to meet the changing needs of our customers and the retailers we serve. Our commitment is to furnish a well-designed, well-maintained and well-marketed retail environment, capable of maximizing traffic and sales.

We are pleased to become partners with retailers, striving for the same goals. We are ready to facilitate communication and share our expertise with you to complete your store within expected timelines.

These criteria act as a guide for the design of all work by Tenants in conjunction with the provisions of the Tenant's lease with the Landlord. Tenants are encouraged to express their own unique design statement within the parameters of the design criteria as outlined in this manual.

National and regional "standard" storefront concepts are respected to the extent that they meet the design criteria. However, Tenants should be aware that some concept modifications might be necessary to comply with the Los Cerritos Center criteria.

The same is true for proposed designs that are overly similar to a neighboring Tenant's storefront design. We wish to make the Mall as diverse and interesting as possible and enable each Tenant to make a singular statement with their design.



CRITERIA MAIN CONTENTS

1.0

INLINE

CRITERIA FOR ARCHITECTURAL, SIGNAGE, AND TECHNICAL DESIGN FOR INLINE RETAIL LOCATIONS.

2.0

FOOD

CRITERIA FOR ARCHITECTURAL, SIGNAGE, AND TECHNICAL DESIGN FOR INLINE FOOD, FOOD COURT/HALL, AND RESTAURANTS.

3.0

BUILDING DETAILS

ARCHITECTURAL DETAILS, REQUIREMENTS AND REFERENCE PHOTOS BASED ON STORE POSITION.

4.0

DESIGN INSPIRATION

SUGGESTED DESIGN MOTIFS AND INTRO TO KEY DESIGN ELEMENTS.

5.0

PROPERTY INFO

PROPERTY LOCATION, CONTACTS, UTILITIES OVERVIEW, OPERATIONS, AND LOCAL PERMITTING INFO.

6.0

SUBMITTALS

REQUIREMENTS TO SUBMIT CONSTRUCTION DOCUMENTS, RENDERS, SIGN DRAWINGS, AND MATERIAL BOARDS.

7.0

ADDENDUM

SUPPLEMENTAL DESIGN AND CONSTRUCTION REQUIREMENTS AND DETAILS PROVIDED AS LINKS TO EXTERNAL DOCUMENTS.



INTERACTIVE NAVIGATION

This Criteria is an interactive document. You may tap or click the top Navigation Bar or the Side Content Bar to navigate directly to that section.

This page serves as a hub to the various sections included in this Criteria.

The sections in this Criteria break down the key categories of information to understand the design and construction requirements to incorporate a successful retail experience. Refer to the overviews included in the left side bar to learn more about the content included in each section.

It is the responsibility of the Tenant, its contractors, subcontractors, architects, engineers, employees, and agents to comply with terms of the Tenant Criteria, including the supplement documents included in the Addendum.

The intent of this Criteria Manual is to:

- Accelerate the leasing process by providing quick answers to questions about specific requirements.
- Establish the design expectations and technical requirements.
- Establish a coherent design by carefully curating and integrating within the mall.
- Guide the design standards.
- Answer basic questions about the design and construction process.
- Save time by minimizing design reviews.



INLINE RETAIL CONTENT OVERVIEW

1.1

DESIGN

CRITERIA FOR ARCHITECTURAL DESIGN REQUIREMENTS FOR RETAIL STOREFRONTS AND INTERIORS.

1.2

SIGNAGE

CRITERIA FOR PRIMARY AND SECONDARY STOREFRONT SIGN DESIGNS.

1.3

TECHNICAL

CRITERIA FOR TECHNICAL DESIGN ELEMENTS TO ENSURE YOUR STORE CAN INTERFACE WITH THE PROPERTY'S BASE BUILDING UTILITY SYSTEMS.

SECTIONS OF INTEREST

BUILDING DETAILS

Includes property reference photos and specific storefront design details.

PROPERTY INFO

Includes information on the Property's building codes, area permitting, and required contractors.

SUBMITTALS

Outlines requirements on how and what to compile for submittals to the Landlord for design reviews.

DESIGN INSPIRATION

Provides visual inspirations for design aesthetics.

The Inline Retail Criteria provides key technical information and design requirements to ensure your store enlivens the consumer experience and interfaces with the Center.

The Tenant and the Tenant's Architect assume the following important obligations:

- Fulfill the intent of the criteria both in concept and in detail.
- Determine and respond to the actual physical conditions of the Tenant's location.
- Maintain and enhance the high standards of quality established in the construction of the Center.
- Ensure the quality of execution of all design material, finish, and detail concepts in the construction of the Tenant's improvement.
- Provide the required detail at all transitions from Tenant storefront to neighboring storefronts, as well as to the base building.



DESIGN CRITERIA

- STOREFRONTS
 - POP OUTS / WINDOW DISPLAYS
 - ENTRY
 - CONSTRUCTION

- DESIGN CONTROL AREA
 - DESIGN REQUIREMENTS
 - PROHIBITED DESIGN ELEMENTS

- MATERIALS
 - GLAZING / WOOD
 - STONE / PLASTER / DECORATIVE GLASS
 - METAL / LEATHER
 - WALLCOVERINGS / SOLID SURFACE
 - PAINT / FAUX FINISHES / FABRIC

- INTERIORS
 - LIGHTING / FLOORING
 - CEILING / WALLS & PARTITIONS
 - RESTROOM / DOORS

SECTIONS OF INTEREST

- BUILDING DETAILS
 - Includes property reference photos and specific storefront design details.

- PROPERTY INFO
 - Includes information on the Property's building codes, area permitting, and required contractors.

- SUBMITTALS
 - Outlines requirements on how and what to compile for submittals to the Landlord for design reviews.

- DESIGN INSPIRATION
 - Provides visual inspirations for design aesthetics.

Tenants are encouraged to express the individuality of their brand through excellent design by forwarding thinking design teams.

This Design Criteria focuses on strong design details visible from the Center common areas. Focusing on a strong storefront design enlivens the retail experience and draws customers in to shop.



> STOREFRONTS

The Center's success is dependent on the creative design contributed by individual Tenants.

It is vital that your Storefront design is integrated with the look and feel of the Center's aesthetic.

The Building Details section includes specific storefront design requirements based on your store's location. These location based requirements must be incorporated into your Storefront's final design.



> ENTRY

ENTRY

Your storefront entry is a critical design feature to create an invitation to shop, as such all stores must express the entry as an identifiable part of the storefront.

I. SWING DOOR ENTRY

- Swing doors should be located in a recessed vestibule a minimum of 3' from the storefront.
- No door swing shall project beyond the maximum allowable primary projection line.
- All other doors are to be hinged, sliding or pivot-type doors. Doors are suggested to be the height of the glazed storefront.
- Recessed entry flooring shall be the Tenant's floor covering.

II. OPEN STOREFRONT ENTRY

- An open storefront must also present an entry zone. Macerich will review all open storefronts for alternate articulation and dimensional elements for all storefronts.
- Tenants choosing to have an open storefront are required to secure the premises after business hours with a coiling, sliding or folding security closure which comply with the following design guidelines:
 - Shall be set back from the lease line a minimum of 4".
 - Shall coil overhead or coil, fold or slide horizontally to retract into pockets or enclosures to conceal from view during business hours.
 - All supports, tracks, guides and operating devices must be concealed flush with adjacent storefront finishes when closure is in the open position and be integrated into the storefront overall design expression.
 - Horizontal tracks are not allowed in the floor surface.
 - Exposed locking devices or latches are not allowed. Key switches shall be concealed and mounted within the Tenant storefront proper.
 - All supports to be provided by Tenant. Suspending closures from existing building structure is not allowed.



> POP-OUTS / WINDOW DISPLAYS

POP-OUTS

Architectural massing articulation in both plan and height are required for all storefronts in all new Tenant areas.

- Exposed conduits, raceways, access panels or equipment may NOT be visible.
- All surfaces of any visible projections must also be finished to match.
- Designs may incorporate sloping tops at no less than a 3 in 12 pitch to accomplish resistant surfaces to collecting debris.

WINDOW DISPLAYS

Displays should be deliberate and integrated into the storefront. Modulation of display systems and built-in architectural components will reinforce the design.

- Display cases must be adequately lit and ventilated.
- Digital monitors are permitted within 1'-0" behind glazing if integrated into the design and approved by Landlord. Coordinate with Tenant Coordinator for exterior applications and to confirm code or local requirements.

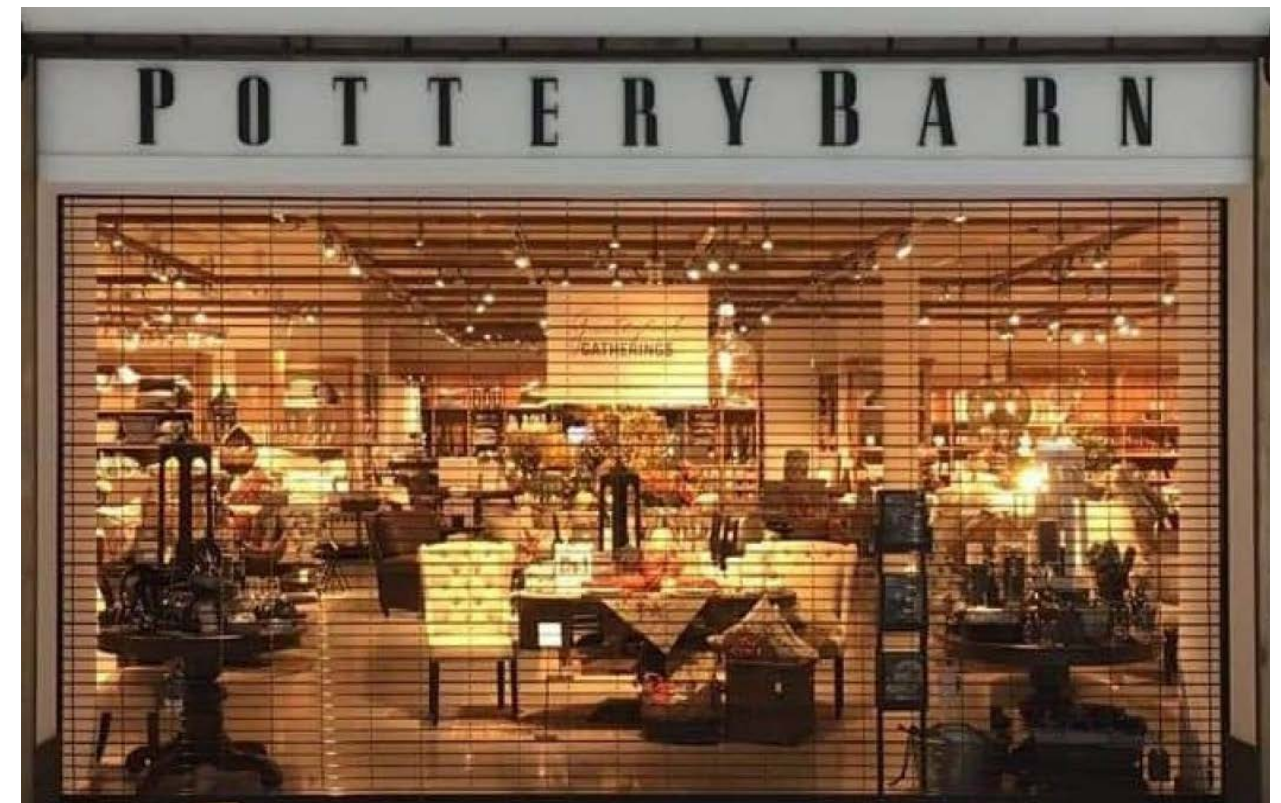

> CONSTRUCTION

STOREFRONT CONSTRUCTION

- All storefront construction shall be self-supported from the floor and independent of the building fascia and bulkhead structure.
- Storefronts may be braced to the overhead structure within the Tenant space.
- Connections to the deck, mall mechanical, electrical, plumbing, or fire protection equipment for support is not permitted. This includes ceiling splay wires.
- In addition to meeting all guidelines provided in this manual, Tenants with entrance doors accessed directly from the parking lot are required to meet the design requirements below:
 - Storefront finishes/material must extend to building parapet and beyond to create varied building heights.
 - Storefront façade must include pop-out and pop-up design elements to create design interest.
 - Three dimensional articulations in both storefront plan and height are required.
 - Tenant finish must cover the entire storefront. Tenant finish must be different than existing mall finish.

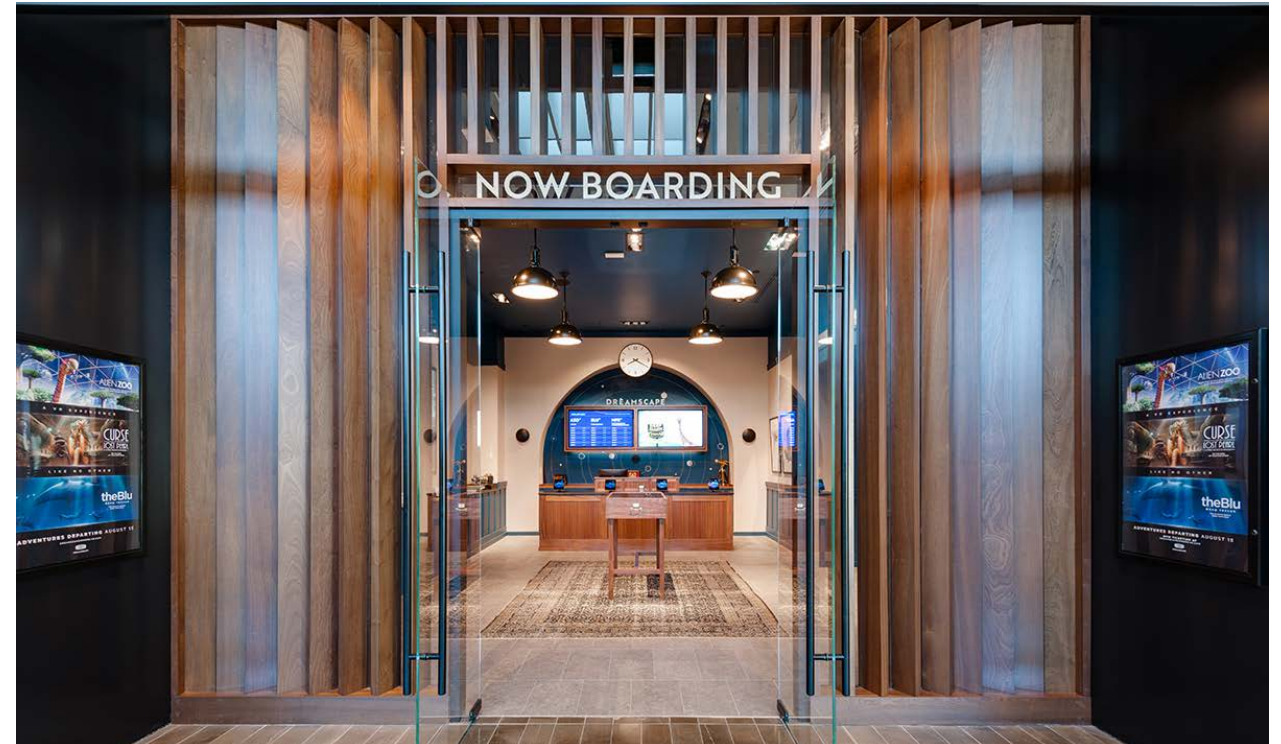

> DESIGN CONTROL AREA

The Design Control Area (DCA) is the zone extended from the storefront lease to 6' inside your space, including all display windows and retail graphics, display fixtures, signs, materials, finishes, color and lighting fixtures within the area.

At Macerich, we take special interest in the DCA as an extension of the retail presentation and showcase of the store's merchandising. The intent is to convey excitement, and give the consumer a reason to shop.

Use of a professional Visual Merchandiser is highly encouraged. Design drawings shall have a display layout plan. The layout plan shall have cut sheets for fixture and/or mannequin types and include photographs of any existing storefronts a Tenant may have that will enhance the layout plan. A rendering is required if photographs are not available.

Stores with both interior and exterior presence must activate both DCA areas. Tenants are encouraged to maintain open visibility into their store to draw in customers.



> REQUIREMENTS / PROHIBITED ELEMENTS

DESIGN REQUIREMENTS

- Ceiling must be a hard surface.
- Lighting fixtures must be consistent with the character of the storefront design.
- Recess all lighting fixtures.
- A minimal profile track lighting system matching the color of the ceiling plane is allowed.
- Hard bases on the walls are required, including any permitted pop out areas.
- Displays should be deliberate and integrated into the storefront. Modulation of display systems and built-in architectural components will reinforce the design.
- Display cases must be adequately lit and ventilated.
- Digital monitors are permitted within 1'-0" behind glazing if integrated into the design and approved by Landlord. Coordinate with Tenant Coordinator for exterior applications and to confirm code or local requirements.

PROHIBITED DESIGN ELEMENTS

- Temporary signs for sales or clearances shall not be hung in the DCA or affixed to the glass inside or outside.
- No pegboard, slat wall or metal shelving of any kind may be placed in or extend into any part of the DCA.
- Security devices or freestanding pedestals are not permitted. They must be integrated and concealed.
- Carpet, vinyl or rubber materials of any sort will not be permitted within the DCA.
- Exposure of incandescent bulbs and/or fluorescent tubes are not allowed.



> MATERIALS

As an important aspect of presenting the Tenant's unique brand image, finish materials are to be composed, articulated and executed in a creative and quality manner.

All materials and applied finishes on the storefront are to be high-grade, durable, non-corrosive and code compliant. They are to be maintained by Tenant at the Tenant's expense. All materials and finishes are subject to Landlord approval, and the inclusion of natural materials is encouraged.

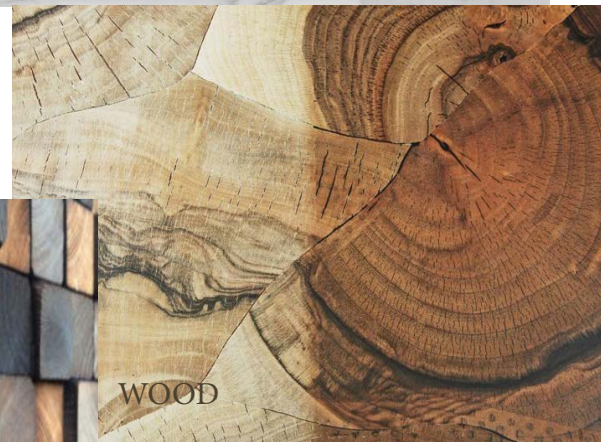

> GLAZING / DECORATIVE GLASS

GLAZING

Storefront glazing, particularly clear glazing, is a key component to establish design character and create an invitation for the customer to visit.

- A minimum of 60 % of the storefront is to be display windows with clear glass.
- Reflective glass (including extensive use of mirror) and/or tinted glass is not permitted on storefronts or in the storefront entry zone.
- Decorative glazing such as colored, beveled, sandblasted or etched glass may be used to create accent pattern and interest. Decorative glazing can be used as an accent, but must meet all material standards.
- All glass shall be tempered. Glazing must be a minimum of ½" thick, and large panes of glazing must be of sufficient thickness to meet code and be properly supported.
- Tenants may be required to provide seismic clips to stabilize tall expanses of glass. Silicone sealant at glazing joints is not permitted.
- Tinting or films applied after the glass is installed is prohibited.

DECORATIVE GLASS

Decorative glass may be considered to provide a unique feature to the storefront.

- Large panes of glazing must be of sufficient thickness to meet code and be properly supported.
- In frame-less assemblies, glass panel joint details edges must be polished, ground or chamfered. Glazing channels at corner conditions must be mitered.
- Tenants may be required to provide seismic clips to stabilize tall expanses of glass. Silicone sealant at glazing joints is not permitted.
- All exterior glazing units must have a solar heat gain coefficient (SHGC) of not more than 0.27 and a U-value of not more than 0.28.



DESIGN CRITERIA

> WOOD/ STONE / PLASTER

WOOD

Wood material can be used for storefront construction but must comply with all local and national code requirements.

- Applications of painted or stained wood may include window frames, decorative trim, molding and solid areas, such as decorative bulkheads. In some cases, it may be used for larger architectural elements, such as columns and entablatures.
- Wood paneling and plank construction are not acceptable unless presented in a highly imaginative concept and approved by the Landlord.
- Wood specified for interior storefronts must be kiln dried, mill quality hardwood and must meet local flame spread requirements (Class III 76-200), as well as comply with all code requirements.
- Painted wood must have a shop quality enamel finish. Wood without a paint finish must receive a clear, preservative sealant.

A mock-up of the materials, colors, textures, or application may be required at Landlord's discretion.

STONE

Granite, marble, limestone, travertine, slate, adoquin and other natural stone materials may be used for storefront applications.

Stone may be polished, unpolished, sandblasted, flamed, honed, split-face or carved.

- Natural stone must be protected against staining and discoloration by means of sealers appropriate to the material.
- Craftsman-like attention to detail is required at all connections and transitions to other materials, and we recommend utilizing metal reveals for a clean finish.
- Corner and edge details must prevent visible unfinished edges. Exposed edges must be quirk mitered, chamfered or polished to match adjacent surface finish.

PLASTER

Cement plaster (studio) and Venetian plaster finishes may be considered for limited storefront applications.

- Apply a finish texture as an even finish of light dash, sand or smooth finish.
- Plaster or stucco should not be the primary storefront material. Finishes should be used in combination with other high quality materials.



> METAL / LEATHER

METAL

Metal panel may be used to provide alternate texture on a portion of the storefront.

- High quality is expected for all metal applications, this includes careful finishing as quality fastener detailing.
- Metals may include: shop-painted aluminum and steel, stainless steel, solid brass, bronze, pewter, or enamel coated steel may be used for hardware, trim and panels when well designed and detailed.
- Minimum 1/2" thick fire-rated plywood or other solid substrate is required behind all metal panels.
- Minimum 18 gauge metal panels are required.
- The following metal surface treatments are not allowed:
 - Oil canning (resulting from light reflection from an uneven or buckled surface)
 - Scratches
 - Warps, dents, occlusions
 - Visible seams or other imperfections
- All seams between metal panels must be identified on the storefront elevation and must be properly addressed during design review process.
- Reveals, turn-in seams, welding or similar must be specified and detailed for approval. Metal panels will not be allowed to directly come into contact with adjacent panel or other materials.
- Visible fasteners must be laid out and approved by the Macerich design team.
- Lap joints and seams must be even and straight and concealed when possible. Outside corners are to be mitered or continuous break shaped.
- Sealants on natural metals are required to prevent tarnishing and must be maintained by Tenant at Tenant's expense.



LEATHER

The use of leather "tiles" for vertical application can add a level of depth and texture to the storefront. However, these tiles should not be used at an elevation that can be reached by the general population due to the more delicate nature of the finish on these tiles to prevent damage over time.

- The Landlord recommends keeping the use of leather tiles on the storefront above 7'-0" AFF.

> WALLCOVERINGS / SOLID SURFACES

WALLCOVERINGS

Wallcoverings can add depth and texture to Tenant Storefronts, but need to be applied accordingly based on the durability of the product.

Vinyl, Paper, or Fabric Wallcoverings are not considered durable and are expressly prohibited in the use of Tenant Storefronts.

- Any wallcoverings located at pedestrian level (below 7'-0" AFF) must be extremely durable and rated by the manufacturer for high traffic use.
- Any wallcoverings located above pedestrian level (higher than 7'-0" AFF) must be durable and washable for maintenance purposes.
- Removable/repositionable wall coverings are not permitted for storefront use.
- All wallcovering applications must appear seamless and be securely affixed with commercial grade adhesive rated for high traffic use covering the entire back of the product.
- All maintenance of wallcoverings is by Tenant. No peeling, bubbling, or other separation of the wallcovering from the applied substrate is permitted to remain, and is the responsibility of the Tenant to repair in a time frame deemed acceptable by the Landlord.

SOLID SURFACE

The use of large format solid surface panels can effectively mimic luxury materials in places where cost may be an issue (IE: Caesar Stone or Cambria), or to provide even, diffuse lighting elements in the storefront (IE: Lumicor or 3Form).

- All solid surface products must be rated for heavy duty commercial applications – residential quality products are not permitted.
- Joints, flat seams, and corner conditions of solid surface materials must be tight and seamless.
- All visible edges must be finished to the same level and quality as the front face of the material.
- If the body of the product is not consistent throughout, a mitered corner detail is required to keep the presentation clean.
- All corners and edges must be eased for safety purposes.
- No adhesive can be visible in the final application.



> PAINT / FAUX FINISHES / FABRICS

PAINT

- Surfaces should be maintained as an even surface finish, at all times.
- Any paint application should show uniformity without evidence of touch-ups or batch variation.
- Paint should be colorfast, and well executed to prevent lap marks, brush marks, or poor coverage.
- Surfaces and materials shall be prepared and staged correctly to avoid problem conditions such as poor adhesion, sagging, chipping or flashing.
- Painted metal surfaces are not allowed.
- Painted gyp board is not permitted on the storefront.

FAUX FINISHES

Faux finishes may be used at the Landlord's discretion.

- Actual samples of the faux finish must be submitted to the Landlord. Photographs of previous examples are helpful but may not be substituted for an actual sample.
- Faux finishes must be executed by a commercial artisan specializing in that medium.

FABRICS

- Fabrics shall be commercial grade and tested in accordance with ACT Guidelines.
- Specifics for flammability and four aspects of fabric durability: Wet & Dry Crocking, Colorfastness to Light, Physical Properties, and Abrasion are to be documented for each fabric specified and available for Landlord review if requested.

The following finishes are not permitted on storefront:

- Laminate
- 4" X 4" , 6" x 6" , 12" x 12" ceramic/glazed tile
- Plywood and particle board



> INTERIORS > LIGHTING / FLOORING

The store interior design should emphasize your merchandise and create an exciting experience for the customer.

It is the Tenant's responsibility to survey, capture and address all existing conditions within the space.

LIGHTING

Lighting can greatly contribute to the design of a Tenant's store, by emphasizing architectural forms as well as highlighting signage, adding color and visual drama to walls and other design elements. The creative use of dramatic lighting is encouraged at entries, show windows and merchandise displays.

- Fixtures must be positioned to avoid glare directed into public areas. Do not over light.
- Wall sconces or decorative lamping may be used to cast light onto storefront forms, provided that bare bulbs are not exposed and that the finish and form of these fixtures coordinate with the overall storefront design.
- Fixture cut sheets will be required to be submitted if this light form is used.
- Sconces shall be commercial grade in quality and size.
- Residential scaled sconces are not acceptable.
- Colors are subject to Landlord approval.
- 2'x2' or 2'x4' prismatic fluorescent lights are not allowed.
- All lighting in the design controlled area to be recessed down lights with exception of any track lighting at display windows.
- Bare fluorescent or incandescent lights allowed in stockroom or if concealed on sales floor only.

FLOORING

- Flooring is required in the full premises including in the recessed entry conditions and storage areas of the store.
- Stores with less than 800 sf. require finished flooring with hard surfaces.
- Apron areas must be signed off with the Tenant Coordinator as part of the submittal documentation.
- Hard surface base is required in all sales areas, including the DCA.
- Ensure floor material is durable.
- Carpet must be commercial grade and meet local code required fire-proof ratings.
- Exposed concrete floors must be sealed.
- Transitions between flooring and common areas must be flush.
- Tenant is responsible to mitigate any/all ADA issues and clear with the appropriate municipality.
- Install tenant floor covering in entry vestibules.
- Sheet vinyl and vct allowed in the stockroom only.



> CEILING / WALLS & PARTITIONS

CEILING

- Concealed light covers to highlight architectural elements are encouraged.
- Multi-level ceilings are encouraged.
- Gypsum wallboard, concealed spline, decorative patterned ceiling panels, and other “high-tech” materials are encouraged.
- Standard 24’x48’ acoustical panels are not allowed in sales areas.
- Tenant sales floor ceilings to be a minimum of 12’-0”aff.
- Fire sprinklers are to be recessed in acoustical ceilings and concealed in hard lid ceilings.
- No combustible materials are to be used above finished ceilings.

WALLS & PARTITIONS

- Demising walls are not designed to accommodate cantilevered or eccentric loads. If Tenant plans to use a demising wall for support of shelf standards, light softs or heavy attachments, Tenant shall reinforce the wall as required by providing additional steel studs or independent supports for the shelf standards.
- Demising walls and ceiling shall be sound insulated to achieve a minimum STC rating of 50 by Tenants who produce above 80 dB (including but not limited to music stores, arcades, etc.) The Landlord will strictly enforce all Tenant’s right to quiet enjoyment of their Leased Premises.
- Tenant shall protect fire proofed columns and braces with gypsum board, and furr out as required.
- The following are required for hair salons, pet shops and all food preparation type Tenants:
 - Walls containing “wet” areas to be constructed of metal studs with water resistant $\frac{5}{8}$ ” type “x” gypsum board.
 - Demising walls of pet shops shall have sheet metal installed on studs, behind drywall, up 3’-0” from floor.
- When Tenant chooses not to install a ceiling within Tenant’s stockroom, Tenant shall extend the partition separating the stockroom from other areas of the store, to the underside of the structure above in order to isolate the stockroom from the sales area attic space. Tenant to verify if this is allowed by code.
- Metal or plastic laminate inserts are required for slatwall. No visible substrate at slats is permitted.
- Recessed wall standards are permitted.
- No open shelving with visible brackets or surface mounted systems are allowed.



> EGRESS DOORS / RESTROOM

EGRESS / SERVICE DOORS

- All secondary exit doors shall be backset so that the door does not swing into the corridor, or exit passageway.
- Doors entering a common exit passageway or corridor shall be labeled with the Tenant name and space number.

RESTROOM

- Restroom(s) is required in all Tenant spaces.
- Restrooms must be designed to meet ADA and building department codes.
- Floor drain and cleanout are required.
- Each restroom must have an exhaust system.
- A waterproof membrane beneath the finish floor surface of ceramic tile up to a height of 4" along all walls is required.
- The ceiling shall be a minimum of 8'-0" above the finished floor level, be constructed of 5/8" type "x" water resistant gypsum and be finished with enamel paint. The ceiling shall contain a vent, which shall be connected to the Landlord's exhaust system, or as pursuant to the Center requirements.
- At a minimum, interior wall finishes shall be a light colored enamel paint with a 4' high wainscot extending 24" on each side of, and 24" beyond the front portion of any water closet or urinal.



SIGN CRITERIA > CONTENTS

PRIMARY SIGNAGE

- CONTENT / DESIGN ELEMENTS*
- PLACEMENT / DIMENSIONS / CONSTRUCTION*

SECONDARY SIGNAGE

- WINDOWS / THRESHOLD*
- AWNINGS / BLADES*
- PROHIBITED ELEMENTS*

EXTERIOR SIGNAGE

- LIGHTING / DIMENSIONS / DESIGN & FABRICATION*
- INSTALLATION / SPACE IDENTIFICATION*

SECTIONS OF INTEREST

BUILDING DETAILS

Includes property reference photos and specific storefront design details.

PROPERTY INFO

Includes information on the Property's building codes, area permitting, and required contractors.

SUBMITTALS

Outlines requirements on how and what to compile for submittals to the Landlord for design reviews.

ADDENDUM

Includes additional info on exterior signage requirements.

Storefront signs are vital to the successful function of the Center.

The goal of this Criteria is to produce a colorful collage of signage that tastefully informs, delights, and stimulates the shopper.

All sign materials must be consistent with the design theme, enhancing the storefront and evoking a positive retail image.

Due to the variety of architectural treatments within Los Cerritos Center, each storefront sign will be carefully considered in relationship to its particular location. What may be appropriate in one location may not work in another. Each proposed sign will be evaluated on its originality and compatibility with neighboring signs, and its overall image within the Shopping Center.

The Landlord reserves the right to disapprove any sign design that is not compatible with these criteria and the aesthetics of the Shopping Center.

This Criteria is intended to harmonize with the leasing documents. It is the responsibility of the Tenant to forward a copy of these criteria to their architect, contractor and various consultants.

No deviation from the enclosed Criteria requirements will be accepted without prior written approval from The Macerich Company.



> PRIMARY SIGNAGE

Your primary sign is an opportunity to express your Brand's identity and individuality at the entry portal of your store.

The following sign types are encouraged as design options for your primary signage:

- **REVERSE CHANNEL (HALO LETTERS)** minimum of 3" deep and projected from the background.
- **INTERNALLY ILLUMINATED** sign housings having unique shapes with letters routed out and formed letters protruding beyond the routed out letter.
- **EDGE-LIT, SANDBLASTED GLASS** with a continuous light source.
- **CAST METAL LETTERS** raised or flush with the fascia surface.
- **GOLD LEAF** on glass or stone.
- **SILK-SCREENED** glass or metal panels.
- **INDIRECT ILLUMINATION** on non-internally illuminated signs (artisan type panel signs).

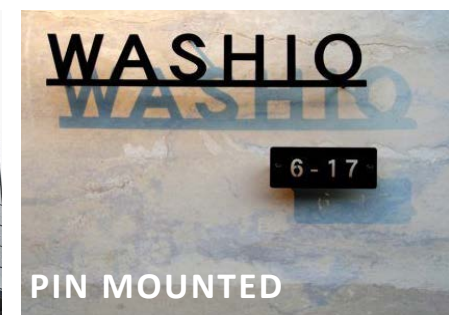
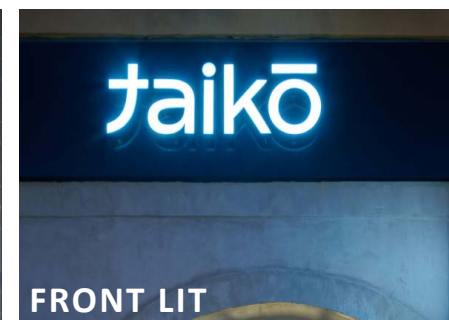

> CONTENT / DESIGN ELEMENTS

SIGN CONTENT

- Sign wording is limited to the Tenant's trade name and shall not include specification of merchandise sold or services rendered, regard-less of the Tenant's legal name. Corporate crests, logos or insignia may be acceptable pending the Landlord's approval and provided they are part of the Tenant's name.
- Storefront signs are to state the store name and/or logo as stated on the Lease, and may not advertise or list items sold.

SIGN DESIGN ELEMENTS

- All primary storefront signs must be illuminated. External illumination designs are subject to Landlord approval.
- Imaginative signs utilizing a variety of materials are encouraged. Adaptation of current sign practices may be necessary in order to comply with these criteria.
- Backlit components must be contained wholly within the depth of the letter. Maximum brightness may not exceed one hundred foot-candles.



> PLACEMENT / DIMENSIONS / CONSTRUCTION

SIGN PLACEMENT

- One sign is permitted per store frontage unless additional signage is approved by Tenant Coordinator. Tenants occupying corner spaces may utilize one sign per elevation with a maximum of two (2) signs, or one sign on a diagonal corner. For unusually long tenant storefronts, more than one sign may be allowed, with Landlord approval.
- Signs may project as shown in storefront conditions found in the Building Details section linked here: [BUILDING DETAILS](#)
- Sign height above common area finished floor: bottom of sign to be AFF 9'-0" minimum.

SIGN DIMENSIONS

- Signs shall be designed as an integral part of the storefront, with letter size and location proportional to the overall storefront design, and in compliance with design district criteria
- Per City of Los Cerritos: Leading Capital letters are not to exceed 18" in height. Lower case letters are not to exceed 14" in height.
- Letter dimensions of greater proportions may be considered if, in the Landlord's opinion, the sign design is of exceptional merit and architectural quality.

SIGN CONSTRUCTION/INSTALLATION

- All storefront signage and lighting both interior and exterior is required to be on a separate circuit and controlled by a time clock. Storefront Signage and lighting are required to be on during operating hours and off during non-operating hours. This includes exterior building storefront signage.
- Electrical raceways are not to be visible.
- High quality fabrications are required. Hums, flickers and light leaks are not permitted. Attachment devices, bolts, clips, threaded rods, fasteners, tubes, raceways, conduit, and other mechanisms are to be concealed. All labels must be away from public view. Signs must comply with all codes and regulations, must bear the UL label, and must have current sign permits.
- Tenant may use Landlord bulkhead for lateral bracing only.
- Threaded rods or anchor bolts shall be used to mount sign letters spaced out from background pane. Angle clips attached to letter sides will not be permitted. All bolts, fastenings, and clips shall be of hot-dipped galvanized iron, stainless steel, aluminum, brass or bronze. No black iron materials of any type shall be permitted.
- All signage shall not exceed a maximum brightness of one hundred (100) foot-candles.
- Advertising placards, banners, pennants, names, insignia, trade-marks and other descriptive material may not be attached to the storefront or glazing.
- Visible weep holes are not permitted.
- Any existing holes from previous Tenant signage must be patched and painted.



> SECONDARY SIGNAGE

In addition to the Primary Sign, all Signage visible from the exterior of the store are considered Tenant Signs. These do not include messages used to advertise products, sales, or special events. Several various Secondary Signs are allowed at the Center and detailed in this section.

The following general Secondary Sign requirements must be met by all Sign varieties:

GENERAL

- Signs must be kept within the projection.
- Signs must be in proportion to the overall storefront and composition.

MESSAGING

- Trade name and logo only, are allowed.
- No taglines may be incorporated.
- Established logos will be allowed and will be counted in the overall area calculations.



> WINDOW / THRESHOLD

Secondary signage types and their requirements include:

STOREFRONT WINDOW SIGNS

If the Tenant wishes to provide additional tenant identity, it is to be located at the pedestrian level on the inside face of the storefront glass.

- Glazing signs are to be translucent (similar to frosted glass), reverse-reading and applied directly to the interior of the glass surface.
- Tenant graphics on storefront glass shall be computer cut fat vinyl graphics (text/letter/logos)
- Maximum allowable area of signage is subject to Landlord's review and approval.
- Tenant graphics/logo will be limited to a maximum of three (3") inches in height.

THRESHOLD SIGNS

In addition to storefront signs, Tenants are encouraged to incorporate signs into their entry way flooring. Landlord will review threshold signs on an individual basis.

- Threshold signs are to be graphics comprised of logos, crests and accent or Tenant's trade name.
- Finish is to be flush with adjacent materials and consistent with entry flooring quality.
- Recommended materials are wood, tile, stone, metal and terrazzo inlays.
- Threshold signs are not to extend beyond their lease line into the Center.

> AWNINGS / BLADE SIGNS

EXTERIOR AWNINGS

Some Tenant storefront designs include projected awnings. Landlord will review awnings and their signage on an individual basis.

- Glass or metal are the preferred materials of choice, although fabric awnings will be considered.
- Awning signage may be considered as the main Tenant's identification at the sole discretion of the Landlord in the interior of the Mall only.
- Signage may occur on the valence of the awning and may be painted or silk screened in a contrasting color.
- Logos shall be silk-screened and submitted with awning and sign drawings. Size of the logo shall be proportionate to the overall width of the awning and subject to Landlords approval.
- The lowest point of the awning or shade shall be a minimum of eight feet (8'-0") above the finished floor. It is the designer's responsibility to ensure that awnings conform to all applicable codes.
- Materials such as Pana-flex, plastic or other vinyl materials shall not be permitted.
- Awnings shall be cleared and maintained in good condition at the sole expense of the Tenant's.

Exterior awning signs are prohibited per Cerritos Municipal Code Section 22.48.300 (17)

BLADE SIGNS

Blade signs are prohibited in the main common area.

They may, however, be allowed in selected side corridors in coordination with the Center's Tenant Coordinator.

A blade sign is a double-sided sign mounted perpendicular to the building facade and suspended on a metal bracket, to be placed near the entrance(s) to a retail space.

The following requirements must be followed for the design and installation of Blade Signage:

- Fabricated use of painted metal signs are encouraged. No molded fiberglass or other plastics may be used.
- Bracket detail may be designated by center and by zone.
- Check with the tenant coordinator for size of blade sign and bracket detail information.

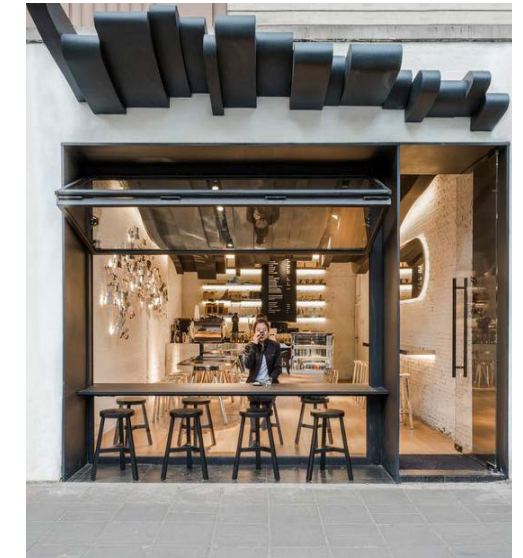

> PROHIBITED SIGNS AND MATERIALS

PROHIBITED SIGNS AND MATERIALS

The following sign types and materials are not permitted:

- Internally illuminated plexi-faced channel letters.
- Vacuum-formed or injection-molded plastic signs.
- Cabinet or standard “can type” signs with illuminated translucent backgrounds and silhouetted letters.
- Exposed skeleton neon applied directly to fascia element.
- Temporary or ‘sales’ signs attached to storefront.
- Freestanding tripod signs.
- Flashing, scintillating, moving, sequencing, audible or odor producing signs.
- Paper, cardboard and Styrofoam signs.
- Credit card and advertising placards, decals, stickers or trademarks.
- Manufacturer labels.
- Carpet or rubber entry mat signs.
- Internally illuminated awnings.
- Signs employing un-edged or uncapped plastic logos or letters with no returns and exposed fastenings.
- No simulated materials (IE: wood grained plastic laminates, Zolatone etc.) or wall covering permitted.
- Signs painted on storefront.
- No radioactive material shall be allowed to be used or installed as part of any tenant construction scope of work. Furthermore, no radioactive signs such as Tritium exit signs shall be allowed in our shopping centers.

> EXTERIOR SIGNAGE > LIGHTING / DIMENSION / DESIGN & FABRICATION

In addition to the previously detailed sign criteria, the following requirements must be followed regarding Exterior Signage:

LIGHTING REQUIREMENTS

- Metal letters, back lit (halo effect) with warm white light (3200K^o - 3500K^o). Letters must be a minimum of 6" in depth, and must be projected from the background with one inch spacers.
- Internally illuminated channel letters, with opaque sides and plastic faces, (3200K^o - 3500K^o) luminous tubing illumination within letters. Letters should not be more than 9" in depth. The Plexi-glass color will be determined on an individual mall basis. Trim caps are to match letter color.
- Exposed neon is prohibited by the City. LED architectural lighting can be considered.

DIMENSION REQUIREMENTS

- Store sign shall not exceed 70% of the storefront width, a distance which shall be determined by the lineal footage of the Tenants lease line.
- Logos cannot exceed 30" square depending upon the application.
- Uppercase letters shall not exceed 24" in height.
- Lowercase letters shall not exceed 20" in height

DESIGN AND FABRICATION REQUIREMENTS

- Letters are to be individually illuminated with white neon. The "Plexiglas" color is to be determined on an individual mall basis. Trim caps are to match letter color.
- No exposed raceways, crossovers, conduit conductors, transformers, etc. shall be permitted.
- All signage and sign components shall be UL listed.
- No exposed raceways, crossovers, conduit conductors, transformers, etc. shall be permitted.
- All exterior signage components (logos and all individual letters) shall stand off the face of the wall surface by a distance of 1/4 inch. This shall be accomplished by the use of nylon spacers placed between the face of the wall and the back of the logo or letter.
- All metal letters shall be fabricated using full-welded construction.



> INSTALLATION / SPACE IDENTIFICATION

INSTALL AND CONSTRUCTION REQUIREMENTS

- A building permit, Mall and City approval shall be obtained prior to sign installation.
- All sign installation will be coordinated with the Landlord prior to initiation of any work by the Tenant and/or his subcontractors.
- Tenant is responsible for the operation of the Tenant's sign contractor.
- The sign contractor, on drawings submitted to the Landlord, shall indicate location of all openings for conduit sleeves and supports in sign panels of building walls. Sign contractor shall install signage in accordance with the approved drawings.
- Tenant's sign contractor shall repair any damage to any finishes caused by his work.
- PK housing (or other U.L. approved insulating sleeve approved by Landlord and local building codes) is required for all through wall penetrations and must be indicated on the sign shop drawings.
- All signs, bolts, fastenings, and clips shall be of hot-dipped galvanized iron, stainless steel, aluminum, brass or bronze, and no black iron materials of any type shall be permitted. No toggle bolts shall be used for sign attachments.
- Electrical service to the Tenant's sign shall be installed by the Tenant and not be part of the Landlord's operating costs. The sign shall be controlled by a time clock.
- Any existing holes from previous Tenant signage must be patched and painted.
- Contact Tenant Coordinator regarding sign company insurance requirements.

EXTERIOR SPACE IDENTIFICATION

- If Tenant has a non-customer door for receiving merchandise, Tenant may place its name and address on said door in a location approved in writing by Landlord's tenant coordinator, using two inch (2") high block letters. Where more than one (1) Tenant uses the same door, each name and address may be applied. Landlord's Tenant Coordinator shall also specify the size, type and color of numbers.
- Tenant may install on its Mall storefront, if required by the US Postal Service, only the numbers of Tenant's street address and only in such location as Landlord shall specify. Check with mall office for more information prior to installing address letters.



TECHNICAL CRITERIA > CONTENTS

- ELECTRICAL**
 - POWER SOURCE / METER*
 - REQUIREMENTS / SYSTEM REUSE*
 - DATA & COMMUNICATIONS*
 - LIGHTING*
- LIFE SAFETY**
 - SPRINKLER*
 - FIRE ALARM*
 - EGRESS*
- PLUMBING**
 - REQUIREMENTS*
 - GAS*
- MECHANICAL**
 - LOAD CALCULATIONS / GENERAL REQUIREMENTS / EXISTING SYSTEMS / EXHAUST*
 - ROOFTOP EQUIPMENT*
 - ROOFTOP DETAILS*
- STRUCTURAL**
 - DESIGN REQUIREMENTS*
 - SEISMIC JOINT DETAILS*

SECTIONS OF INTEREST

- BUILDING DETAILS**

Includes property reference photos and specific storefront design details.
- PROPERTY INFO**

Includes information on the Property's building codes, area permitting, and required contractors.
- SUBMITTALS**

Outlines requirements on how and what to compile for submittals to the Landlord for design reviews.
- ADDENDUM**

Includes additional info on exterior signage requirements.

The Inline Technical Criteria provides buildings details and design requirements for the Center's technical systems.

It is the Tenant's responsibility to verify existing conditions and comply with all applicable codes and standards for technical systems.

Tenants are required to adhere to the full criteria during their design and construction.

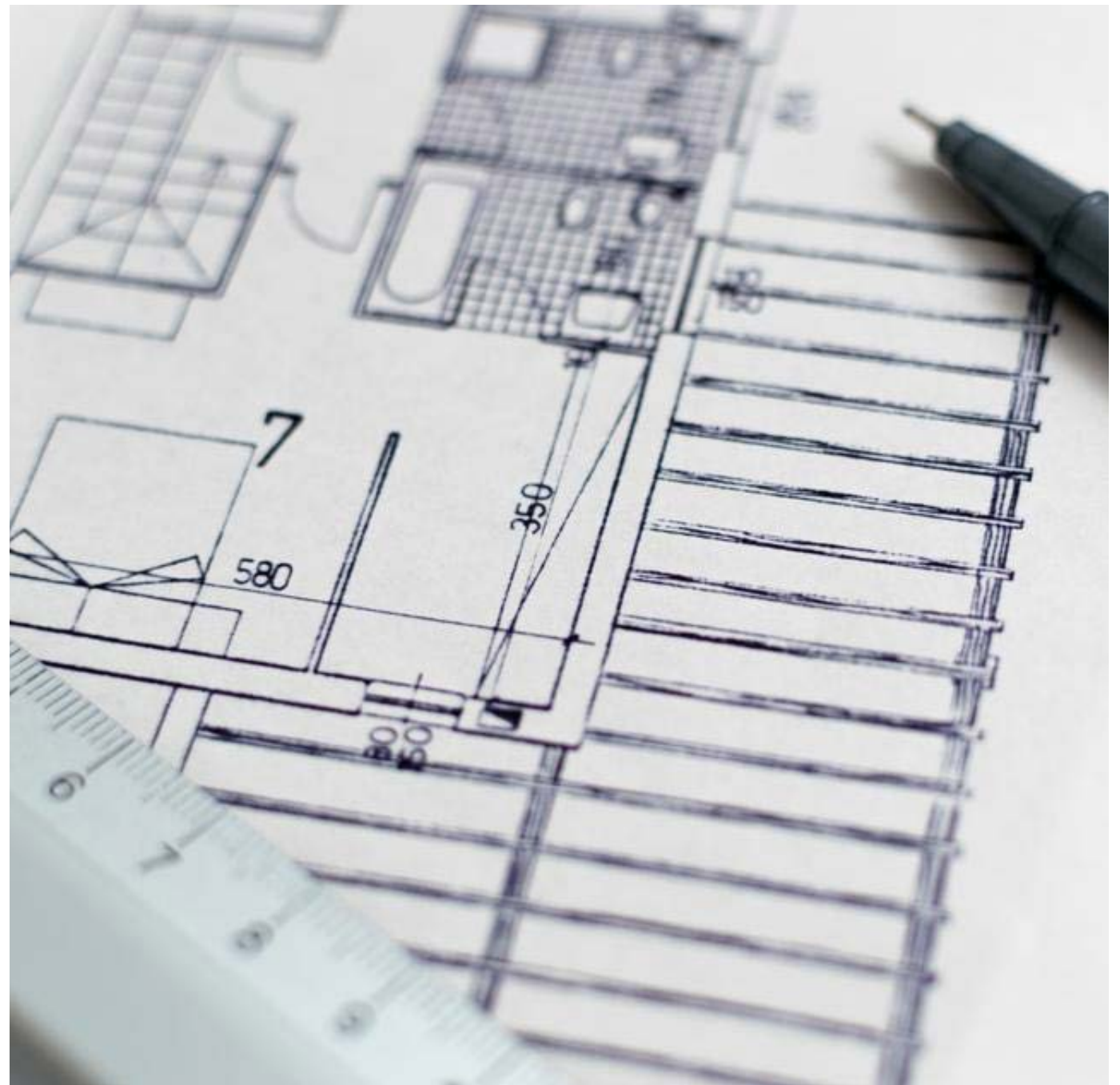

> ELECTRICAL > POWER SOURCE / METER

PROVIDED POWER SOURCE

Tenant shell spaces typically provide an empty conduit to a main power source. The main power source available for Tenant connections will be 277/480v or 120/208v, 3 phase, 4 wire available from the nearest electrical room.

The Landlord may provide temporary electrical service to the Tenant, during construction. The charge for this temporary power will be paid by the Tenant as per the Tenant Construction Rules and Regulations. Temporary wiring needed to work in the space should be connected to the Tenant's electrical service and not common area outlets.

I. TENANT REQUIREMENTS

Tenants are required to meet the following requirements related to connecting to their power source:

- **MAIN POWER SOURCE CONNECTION** must be performed by the Landlord's designated electrician, at the Tenant's expense.
- **FEEDERS** to the tenant space are the Tenants responsibility, installation of a dry type transformer, panels and complete distribution throughout their space.
- **DEMAND CHECK METER** must be installed in the mall electric room or in Tenant's space for those areas of the mall where applicable. (Check with the mall's Operations Manager or Tenant Coordinator prior to construction start).
- **UTILITY COMPANY ARRANGEMENT** is a Tenant responsibility to arrange for electrical service and meter at Tenant's expense.
- **LARGER CONDUIT**, if required, is a Tenant responsibility to install from the power source to the demised premises.

METER DETAILS

Electrical use is sub-metered and charged by the Landlord. However, check with your Tenant Coordinator as some parts of the Center are not sub-metered. If a space is not sub-metered, it is the Tenant's responsibility to contact the Utility company for meter installation.

I. ELECTRIC METER REQUIREMENTS

- **REVENUE GRADE** meters are required.
- **DISPLAY** must be at least 6-digits.
- **METER MUST READ** demand (kW) and usage (kWh).
- **METER MUST CAPTURE** the electric usage of the entire Tenant space, including HVAC units. If this is not possible, then it must be noted.
- **METERS WITH CT** must note if a multiplier is required and what the multiplier is on the face of the meter.

II. EXISTING SUB-METERS

If there is an existing electric sub-meter in the Tenant's space:

- **RECOMMISSIONING** the sub-meter is the Tenant's responsibility to ensure proper installation and functionality or;
- **NEW SUB-METER** may be installed by the mall required vendor, and will be at the Tenant's sole cost.

> REQUIREMENTS / REUSE

SYSTEM REQUIREMENTS

- **NO DIRECT ATTACHMENT** to the slab, roof deck, ductwork, piping or conduit above. Conduit and raceway hangers, clamps, light fixtures, junction boxes, supports, etc. must be fastened to joists and/or beams.
- **ACCESS PANELS** must be provided at all junction box locations and at smoke detectors above the ceiling.
- **IDENTIFY** all Tenant equipment in the Mall electric room with clear labels that include the Tenant name and space number.
- **TENANT EQUIPMENT** typically includes, but is not limited to: all outlet boxes, floor boxes, wire raceways, power/telephone poles, plug-in molding, wiring devices, and hanger supports for a complete distribution must be furnished and installed by Tenant.
- **EQUIPMENT POWERED BY TENANT** typically includes, but is not limited to: HVAC units, water heater, store fixtures, signage, music systems and any other fixtures or equipment provided by Tenant.
- **FEEDERS** are typically the Tenant responsibility to the Tenant space.
- **UL LABELS** on all material and equipment must be new and of a commercial grade and where such labeling applies.
- **WATERTIGHT FLOOR BOXES** are required.
- **PULL BOXES/J-BOX MATERIAL** must be a minimum of 12 gauge galvanized steel outlets. Boxes in walls must be galvanized pressed steel or case metal. Caulk around boxes to eliminate noise transmission.
- **CONTROLS** including Manual or magnetic starters, switches, contactors, relays, time switches, safety devices, dimmers and other controls must be commercial type with heavy duty ratings and must be installed in strict conformance with the manufacturer's recommendation and applicable codes.

- **EXPOSED WIRING** is not permitted. All wiring of any type must be installed in conduit or must be metal clad cable (MC). Metal clad cable will only be allowed for concealed branch circuit wiring within the demised premises. Flexible conduits must be used for connections to vibrating equipment.
- **COPPER** is required for all wiring.
- **CONDUIT** is required for all wiring, including low voltage.
- **GROUND SYSTEM TO BUILDING STEEL** as structure is designed with a "UFER" grounding system.
- **INSTALL TRANSFORMERS** below finished ceilings. They may not be anchored to or suspended from the existing Mall structure, exterior or demising walls.
- **MAIN CIRCUIT BREAKER** for the Tenant will be furnished and installed by the Landlord at the Tenant's expense.
- **SERVICE SIZE** requested by Tenant is subject to approval by Landlord. If the Tenant's electrical requirements exceed the standard size provided by the Landlord, the Tenant will submit total Load Calculations to confirm their requirement. Tenant is responsible to confirm the service size before work commences.

REUSE OF EXISTING ELECTRICAL SYSTEMS

Tenant's electing to re-use the existing electrical system (if applicable) in their Tenant space shall:

- **SUBMIT A LETTER** to the Landlord from the Tenant's electrical engineer stating that the existing electrical system is not being altered.
- **VERIFY SYSTEM CONNECTS** to the building management system for lighting controls and Fire Alarm. Tenant shall use mall required contractor at Tenant's expense to ensure code-compliant, connected system is complete.

> DATA & COMMUNICATIONS / LIGHTING

DATA AND COMMUNICATIONS – INSTALL AND PROVIDER REQUIREMENTS

Telecommunications service is provided and administered throughout the Center by Granite Grid. The service includes a dedicated concierge customer service representative for each Tenant, high-bandwidth service (tailored to suit Tenant demand), centrally coordinated installations, moves and repairs.

- **ACCOUNT SETUP AND SERVICE INSTALLATION** is the Tenant responsibility to coordinate direct through Granite Grid. Other data providers are not permitted at this property as they do not have an access agreement in place. ****It is highly recommended to coordinate service install a minimum of 4 weeks in advance.**
- **TELEPHONE DEMARC WORK** must be performed by Landlord's approved telephone subcontractor, Granite Grid.
- **TELEPHONE SERVICE** is the Tenant responsibility to coordinate directly through Granite Grid.

LIGHTING – SYSTEM REQUIREMENTS

- **LIGHTING IN TENANT SPACE** is the Tenant's responsibility. The Tenant will not install any lighting outside the Tenant's space with the exception of Mall required standard lighting at back doors. These fixtures shall be photo cell controlled.
- **LIGHTING SCHEDULE** is required for review in conjunction with a reflected ceiling plan.
- **TIME CLOCK** is required to control display window lighting and be on during the hours the Shopping Center is open.
- **DISPLAY WINDOW LIGHTING** at the ceiling must be glare-free and at approved levels at the storefront glass line and not hang down below the top of storefront glass.
- **RECESSED INCANDESCENT DOWN LIGHTS** are permitted.
- **DECORATIVE LIGHTING FIXTURES** for storefront illumination, such as luminous ceilings, chandeliers, pendant or wall units or clear type glitter strips are permitted if approved by Landlord. No strobe, spinner or chase type lighting shall be used.
- **CODE REQUIRED LIGHTING** such as exit, emergency and night lights must be provided throughout.
- **SALES AREA FLUORESCENT LIGHTING** must be recessed and must use metal parabolic louver type lenses with a minimum of 18 cell configuration for a standard 2' x 2' fixture. Bare lamp fluorescent or fluorescent fixtures with acrylic prismatic lenses may be used only in concealed areas or stock rooms.
- **TRACK LIGHTING** may be used if the track is painted to match the ceiling color.
- **LIGHTING CONTROL SYSTEM** is the Tenant responsibility, including connection to the Building Management system and connection to the Fire Alarm system.

> LIFE SAFETY > SPRINKLER / FIRE ALARM / EGRESS

SPRINKLER SYSTEM REQUIREMENTS

- **SPRINKLER MODIFICATIONS** are the Tenant's responsibility, designed and installed in accordance with NFPA 13.
- **SPRINKLER DESIGN AND INSTALLATION** must be performed by the mall required sprinkler contractor.
- **OPEN CEILING STANDARD SPRINKLER HEADS** will be quick response upright bronze heads.
- **FINISHED CEILING STANDARD SPRINKLER HEADS** will be quick response semi-recessed chrome heads.
- **DESIGN CONTROL AREA** requires flush mount heads.
- **FIRE EXTINGUISHER REQUIREMENTS** are the Tenant's responsibility to confirm with the local or state fire marshal relating to quantity and location of fire extinguishers. At minimum, Tenant is to install at least one wall hung, 2A 10BC dry type U.L.- listed fire extinguisher.
- **PIPING** must be as close to walls and as high to underside of roof framing as possible.
- **LANDLORD NOTIFICATION** is required in writing at least 24 hours in advance of making any modifications to the sprinkler systems. Contractor must notify the fire department and any alarm monitoring company for verification that the system is fully drained. The contractor must notify the Landlord when the system is back on line.
- **CLEARING ALARMS** must be coordinated with Security or Mall maintenance supervisor at least 60 minutes prior to any drain down. Contractor shall remain for one (1) hour after the system has been refilled to check for leaks or other problems.
- **OVERNIGHT DRAINING** is not permitted. All systems have to be charged and operational when worker leave for the night.
- **SPRINKLER WORK HOURS** must be done between 7:00 AM and 4:00 PM Monday through Friday, so the fire system can be filled and tested by 5:00 PM. See the Tenant Contractor's Rules and Regulations for the cost for each shut down of the system, which is required to be paid before the system is drained. The Mall staff or approved contractor will drain and fill the system.

FIRE ALARM REQUIREMENTS

- **FIRE ALARM DETECTION SYSTEM** is a Tenant responsibility to provide within the Tenant space as an extension of the Landlord's building-wide addressable fire alarm system.
- **FIRE ALARM INSTALLATION** must be performed by the Landlord's designated contractor.
- **FIRE ALARM TIE-IN** to the building wide addressable system must be performed by the Landlord's designated contractor.
- **OCCUPANT NOTIFICATION** must be provided within Tenant spaces (on a Tenant-by-Tenant basis) that exceed the Code's thresholds based on the occupancy classification of the individual Tenant space.
- **DUCT DETECTOR** is required on any HVAC unit 2000 CFM or larger in the air supply & return of each unit. The duct detector must have remote test and alarm indicator station per City code.
- **SUBMIT PLANS** to the Fire Prevention Bureau for approval. The Tenant/Tenant's Contractor is responsible for all city testing and inspection fees.

EGRESS REQUIREMENTS

- **DISTRIBUTION OF UTILITIES** through a newly constructed or an altered exit passageway is prohibited except for equipment and ductwork specifically serving the exit passageway, sprinkler piping, standpipes, electrical raceway for fire department communication and electrical raceway serving the exit passageway.

> PLUMBING > METER / SYSTEM REQUIREMENTS

SYSTEM OVERVIEW

Tenant shell spaces are typically provided a domestic cold water line and sanitary line stubbed into the space. The following criteria must be followed during the design and construction of the Tenant space:

SYSTEM REQUIREMENTS

- **SHUT OFF VALVE** located at eye level in a wall behind a labeled access door is required. Locate in or near employee restroom and/or as designated by Landlord.
- **COPPER** is required for all domestic supply lines and condensate lines.
- **ELECTRIC WATER HEATERS** are required for domestic hot water.
- **SANITARY VENTS** through the roof shall be a minimum of 4" and extend a minimum of 8" above finish roof. All roof repairs to be by the Landlord's required roofer at Tenant's expense.
- **ABOVE GROUND SANITARY VENTS** (other than food waste) must be service weight BUIIcast iron, with fittings matching the same weight as the pipe.
- **FLOOR DRAINS** are required in the toilet room and in all "wet" areas.
- **WATERPROOFING** must be installed in all "wet areas" such as kitchens, restrooms, mop sinks, drinking fountains, etc. The waterproof membrane must extend 4" vertically on all demising walls. This membrane will be water tested by the General Contractor and inspected and signed off by Mall Personnel. If the membrane fails the water test, it must be replaced.
- **CLEAN OUTS** must terminate flush with the finish floor or wall. No clean outs are permitted above the ceiling. Floor or wall cleanouts must be provided every 50' with ready access.
- **GARBAGE DISPOSALS** are not allowed.
- **HAIR SALONS/PET SHOPS** must provide hair and solids interceptors on all sinks and basins which may receive human or animal hair. After installation, these hair interceptors shall be properly maintained so as to keep the sanitary system free from any adverse conditions. A maintenance contract with Mall-approved vendor is required to be submitted for record with Mall Operations
- **HAIR RECEPTORS** must be installed on all sinks, basins, and special sanitary units which may in any way receive human or animal hair.
- **KITCHEN SINKS** including pot sinks, scullery sinks, pre-wash sinks and other kitchen units must be connected to a grease trap.
- **DISHWASHERS** may not be connected to grease trap.
- **GREASE INTERCEPTOR** must be designed and approved by Landlord prior to installation, especially if located outside the lease line.
- **OIL COLLECTION AND HAULING SYSTEM** is required for Tenants with fryers or other grease/oil generating equipment that does not run through an interceptor. Landlord does not provide a centralized collection point.
- **BACKFLOW PREVENTERS** are required for food service, hair salons or other Tenants with equipment or operations that have the possibility of backflow. These must be certified and acceptable to the water district and checked yearly or as required by the local authority having jurisdiction.
- **ADA RESTROOMS** are required in every Tenant space with a minimum of one water closet and one lavatory and in accordance with local code officials and must include a 3" floor drain. Mop sinks and water fountains must be installed per local code requirements. An exception to this requirement is only permitted for Food Court Tenants who are within close proximity to the public restrooms upon approval of the Landlord and local code official.
- **WATERLESS URINALS** are required in tenant restrooms when urinals are used.
- **LOW-FLOW WATER CLOSETS** using 1.6 GPF or less gallons per flush are required where water closets are used.
- **OPERATION SENSORS AND LOW-FLOW HEADS** using 0.5 GPM or less are required if Tenant is installing a Restroom.

> GAS

GAS SERVICE

Gas may be available at the Center but is generally not available to Retail Tenants. If available, Tenant, at its sole cost and expense and in compliance with local code must procure gas service to and within the demised premises and will make all necessary arrangements with the local Gas Company for such service.

I. SERVICE REQUIREMENTS

- **GAS METER INSTALLATION** at gas meter header is the responsibility of the Tenant.
- **GAS PIPING INSTALLATION**, when allowed, is the responsibility of the Tenant to provide and install. Roof piping must be placed on pillow blocks or similar arrangement. All roof repairs to be by the Landlord's required roofer at Tenant's expense.
- **PRESSURE REGULATORS** required for connection to Tenant's equipment is the responsibility of the Tenant. Coordinate with Landlord for regulator vent routing.
- **SEISMIC AND MANUAL SHUTOFF DEVICES** are required for the entire gas piping system and equipment or fixtures and color coded or identified as such as required. Seismic valves must be: UL- approved; FM-approved; or, ACSE 25-compliant. All new development and newly tenanted restaurants need to have seismic gas shut-off valves installed on Landlord side of the meter, at each individual space.

> MECHANICAL > LOAD CALCS / GENERAL / EXISTING / EXHAUST

Tenant spaces must provide stand-alone HVAC systems through package rooftop units placed directly over their space.

LOAD CALCULATIONS

- **HEATING LOAD CALCULATION** must maintain the minimum space temperatures in sales and public spaces of 68 degrees F and 50 degrees F in non-public spaces.
- **COOLING LOAD CALCULATION** must maintain the minimum space temperature of 73 degrees F and a maximum of relative humidity of 55 degrees F and shall take into account all interior heat producing items such as people, equipment, roof and exterior walls.

GENERAL REQUIREMENTS

- **VIBRATION ISOLATORS** are required to be installed on all HVAC equipment, whether on the roof or within the Tenants space.
- **MAXIMUM NOISE** criteria of NC40 is required for all spaces except kitchens and other similar work areas.
- **DUCT MOUNTED SMOKE DETECTORS** are required for systems that total 2,000 CFM or greater and must be connected to the main fire alarm panel, if applicable. Each duct smoke detector must have a remote key operated reset/test device mounted with in the Tenant space and an addressable relay module. Use Landlord's designated contractor for connection to the main fire alarm loop. The cost associated in monitoring Tenant's space will be the Tenant's responsibility and will be included in Tenants monthly billing.
- **AIR BALANCE REPORT** is required prior to closing out construction and will be performed by an independent test and balancing agency at the sole cost and expense of the Tenant.
- **BOTTOM FED HVAC** units are required for supply and return air.
- **CONDENSATE LINES** from HVAC units must be copper, run at right angles, drain into the Tenant space, and (if applicable) secured to the roof per mall required roofer's specifications.
- **RETURN AIR DUCT** must be from the finished ceiling back to the HVAC unit. Ceiling return air plenum is not acceptable.
- **FIRE DAMPER ASSEMBLIES** (including sleeves and installation procedures) must be UL listed and approved by the building inspector preceding installation. Install duct and ceiling access to fire dampers. Smoke detectors may be required in all return air or exhaust ductwork. The detectors will over ride and shutdown the air handling equipment when smoke is discovered.
- **FIBERGLASS DUCTS** are not permitted for HVAC trunk lines. Flex duct is permitted for run outs within the Tenant premises and is limited to a maximum distance of 4'.

EXISTING SYSTEMS

The Lease may allow some Tenants to reuse existing HVAC system equipment. In such cases, the following requirements must be followed:

- **CONFIRM** the existing system meets the Tenant Criteria requirements.
- **REPLACE** any units the Landlord deems in need of replacing. This may occur anytime during the terms of the Lease. Replaced units must adhere to the Tenant Criteria.
- **REUSE** of equipment older than 5 years is not permitted.
- **ALTERATION** of the existing system must be submitted and approved by the Landlord.
- **SUBMIT DOCUMENTATION** of the following prior to opening:
 1. A letter from an HVAC contractor asserting that the HVAC unit(s) operate in "like-new" condition.
 2. A copy of the maintenance agreement for the unit(s).
 3. Photographs of the existing unit(s) provided by the Tenant's HVAC maintenance contractor.

EXHAUST REQUIREMENTS

- **ODOR PRODUCING TENANTS** such as restaurants, pet shops, hair salons, nail salons, and the like must maintain 10% negative air pressure with respect to the Mall by providing make-up air equal to 90% exhaust air volume.
- **SEPARATE MAKE-UP OUTDOOR AIR SYSTEM** may be required to balance Tenant's exhaust system. Spaces that require exhaust must be designed to provide negative air pressure relative to adjoining conditioned spaces to prevent odor transfer.
- **ROOF MOUNTED EXHAUST FANS** must be ducted to ceiling grilles located approximately in the center and rear of the demised premises and specifically near the area where the odors are generated. The system shall be designed to cause the exhaust air to gravitate from the Mall common area to the odor producing area and then exhausted out.
- **EXHAUST FANS** must be interlocked with the light switches for the store customer service area.
- **OPERATION** of the combined HVAC and exhaust system must be on during all hours that the Tenant is open for business.
- **STORE EXHAUST SOLUTIONS** shall not include air filtration systems or bathroom exhaust fans.

> EXHAUST / ROOFTOP EQUIPMENT

SPECIFIC REQUIREMENTS FOR ODOR PRODUCING TENANTS

- **NAIL SHOPS** may be required to install scrubbers. This will be determined on a case by case basis.
- **ODOR PRODUCING AREAS** must include the necessary equipment to remove any odors. This work will be approved in writing by the Landlord and at the sole expense of the Tenant. Examples of such Tenant's include; hair or nail shops, pet shops, and food preparation shops.
- **ROOF VENTILATOR** model is required to use motor driven and factory curb Supreme upblast installed at a minimum of 40" from roof membrane to discharge. Use a gauge welded exhaust duct. Provide makeup air no less than 85% of amount of exhaust.
- **SPECIAL MAKEUP AIR** as required by special conditions such as grills, restaurant exhaust systems, etc., will be provided by the Tenant. Along with the HVAC unit, the Tenant may use an evaporative cooler.
- **SMOKE DETECTORS** may be required in all return air or exhaust ductwork to override the air handling equipment and provide shutdown when smoke reaches the equipment.

KITCHEN EXHAUST REQUIREMENTS

- **LANDLORD REVIEW** is required to ensure the exhaust does not compromise the ventilation air of adjacent mall roof top units.
- **EXHAUST FAN** must be a SWSI centrifugal fan which must be fitted with a minimum 10' stainless steel upblast. Guy wires must be attached to the roof in order to secure the stack. Use the mall roofer for connection of the guy wires at Tenant's expense.
- **GREASE GUARD CONTAINMENT SYSTEM** (or approved equal) must be installed to protect the Landlord's roof. A quarterly maintenance program must be in-place for the grease containment units. Proof of the maintenance contract must be presented to Operations Manager prior to the store opening.

ROOFTOP EQUIPMENT REQUIREMENTS

- **PIPING** for the rooftop equipment must be provided and installed by the Tenant in coordination with the Landlord.
- **INSTALLATION INFRASTRUCTURE** including all curbs, supports, lintels, pipes, ducts, vent caps, air inlets, exhaust hoods, louvres, flashings, counterflashing's, etc. are the Tenants responsibility.
- **CURB ADAPTERS** are only permissible at the discretion of the Landlord.
- **PAVERS** must be placed around the roof top equipment and from the main pathway to the equipment in order to protect the roof from traffic.
- **EQUIPMENT SCREENS** for rooftop shall meet Landlord requirements. All equipment must be hidden from public view from the parking lot per City of Los Cerritos.
- **PAINTING EQUIPMENT** including screening, equipment, ductwork, and piping is required to match the roof deck per Landlord specifications.
- **ROOF MEMBRANES** are required for mounted grease exhaust equipment and shall be a single 60mil sheet of TPO roof membrane, loose and laid over the base mall primary roof membrane. This additional sheet of TPO shall be installed minimum 5' beyond all roof top kitchen equipment and help in place by concrete pavers at the corners and or as required to keep the membrane in place and afford the ability to replace as necessary when it becomes soiled.
- **LABELS** are required on all Tenant equipment.
- **ABANDONED EQUIPMENT** must be fully removed, including any associated curbs and patched accordingly.
- **120-VOLT OUTLETS** are required for all HVAC units from the Tenant's electrical service mounted to the unit on the rooftop.
- **EXPOSED DUCTWORK** is not allowed on the roof.
- **WEATHERHEAD** is required when multiple A/C refrigeration lines penetrate the roof.
- **SEAL NEW PIPE PENETRATIONS** though the roof with new prefabricated lead or metal pipe sleeve flashing. Flashing flanges should be installed in a manner acceptable to the roofing manufacturer and the Landlord.
- **CONTROL AND ELECTRICAL WIRING ROOF PENETRATIONS** shall be made through the equipment curb or roofer required flashing.

> ROOFTOP EQUIPMENT

I. ROOFTOP EQUIPMENT LOCATION REQUIREMENTS

- **VISIBILITY OF EQUIPMENT** from parking lots or adjacent streets is not permitted. Locate all roof top equipment as far from side walls as possible. Otherwise, equipment must be screened.
- **DISTANCE BETWEEN FRESH AIR INTAKE AND EXHAUST** units shall be a minimum of 15’.
- **FRESH AIR INTAKE** cannot draw in from Tenant exhaust. It is the sole responsibility to design and locate the distance such that Tenant’s exhaust cannot be drawn into the Fresh Air Intake of ANY existing roof top equipment.
- **DISTANCE ROOF PENETRATIONS** so that they may not be so close to one another that they interfere with proper flashing, or be installed in any roof waterway or area of the roof which ponds water. If placement of any curb or platform causes restriction of water flow and/or creates a ponding situation, a cricket will be constructed at the upslope side of the curb. Crickets can be formed from Perlite roof insulation to provide a minimum slope of 1/4” per foot.
- **DISTANCE BETWEEN NEW IMPROVEMENTS** and existing parapet walls, equipment curbs, or any rooftop projection, should be no less than 24” to allow for proper flashing and sealing of the roof membrane.
- **INSTALLATION OF EQUIPMENT** must be located directly over tenant’s demised space.

II. ROOFTOP STRUCTURAL REQUIREMENTS

- **STRUCTURAL ENGINEER** registered in the state in which the work is being performed must be used to design and evaluate equipment placement and provide structural drawings and detail for Landlord’s review.
- **LOCATE** roof top equipment over major structural elements.
- **NORDSTROM WING ROOFTOP EQUIPMENT** is to be installed within a specific roof zone designed to carry the additional weight. Check with the Operations Manager or Tenant Coordinator as to the exact location of the zones in this area.
- **REINFORCE** the roof system to adequately support the weight of any equipment added.
- **REMOVAL** of structural or miscellaneous bridging, blocking, etc., is not permitted.
- **MODIFICATIONS** to the existing structure must be approved by the Landlord before any work begins.
- **AT WORK COMPLETION** the Tenant’s structural engineer shall submit a letter stating that the roof top equipment has been installed in accordance with the engineer’s recommended design.
- **REMOVE AND DISPOSE** existing rooftop equipment that is not being used by the Tenant or at the Tenant’s expense.

III. PLACEMENT NEAR SOLAR PANELS REQUIREMENTS

- **DO NOT PLACE** equipment within 10 feet of any solar inverter or AC junction box.
- **AVOID INTERFERENCE** with solar panel production by placing objects no closer than the distance defined as 2 times their height. For example, if a 4 foot HVAC unit is installed, it must be located at least 8 feet away from a solar panel. However, in no cases, regardless of the height shall an obstacle be placed within 3 feet of solar equipment.
- **DO NOT ADD** conduits, pipes or other devices to existing conduit carrying devices.
- **DO NOT ROUTE** wires, pipes or other devices across or over existing solar equipment.
- **LANDLORD MUST REVIEW AND APPROVE** all modifications within 20’ of solar equipment.

IV. ROOFTOP WORK

- **MALL APPROVED ROOFING CONTRACTOR** is required for all roof work throughout the center.
- **WARRANTY COMPLIANCE** is the responsibility of the Tenant and mall roofing contractor.
- **ROOF ACCESS** shall be coordinated and scheduled through Mall Operations.
- **DAMAGE** to the roof structure caused by hoisting installation and the maintenance and/or servicing of Tenant’s equipment will be the sole cost and expense of the Tenant to repair.
- **QUALITY OF WORK** is subject to inspection by the Landlord and, if found unsatisfactory, reject.
- **WELDING BLANKETS** are required blankets to protect Landlord’s roof during any welding on the roof level.
- **WELD INSPECTIONS** may be required at the sole cost and expense of the Tenant.
- **COATING** on all materials, welds, connections, etc. installed by Tenant for the HVAC system is required to withstand corrosion.
- **WORK DURING INCLEMENT WEATHER** is not permitted. Tie-in of flashing materials to moist or dusty surfaces should not be attempted.
- **RESTRAIN** all electrical conduit, metal pipe, or plastic piping to appropriate sized wood blocking set into roofing cement. Attachment to blocking should allow for movement due to thermal expansion and contraction.
- **USE APPROVED ROOFING CONTRACTOR** to tie in platforms, curbs, and sleepers into the existing roof membrane, at the sole cost of the Tenant, in a manner acceptable to the roofing manufacturer and the Landlord.

> ROOF MOUNTED EQUIPMENT

Requirements for Roof Mounted Equipment

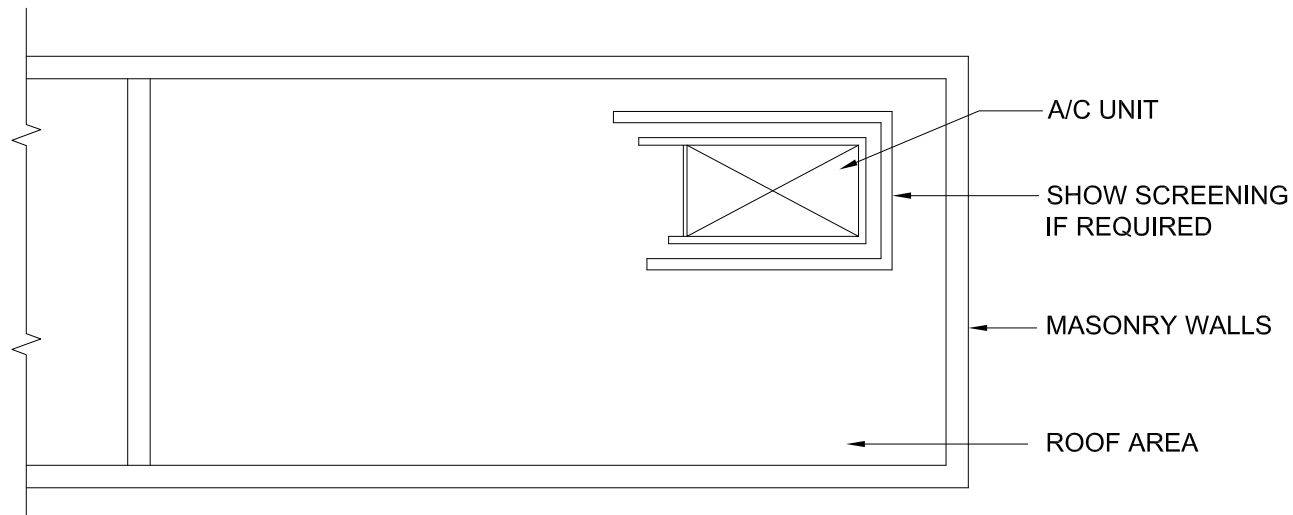

ROOF PLAN

SCALE: N.T.S.

NOTE:
ROOFTOP SCREENS MUST BE
DESIGNED TO BE ARCHITECTURALLY
COMPARABLE WITH THE BUILDING

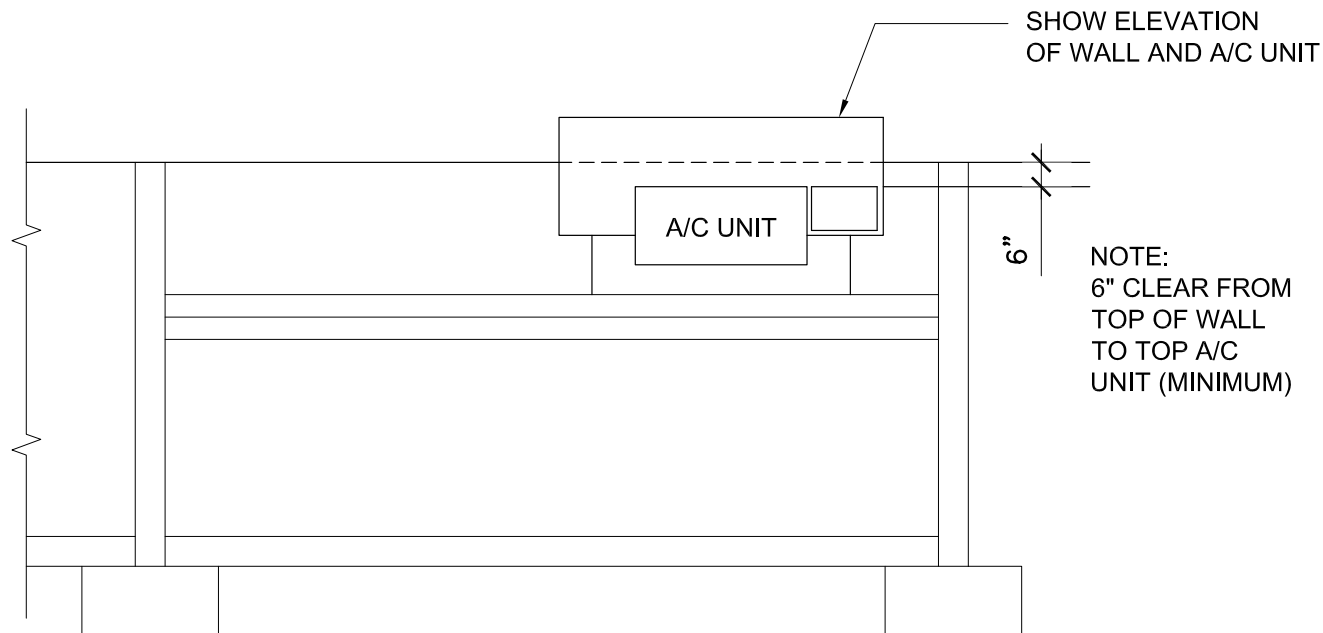

BUILDING SECTION:

SCALE: N.T.S.

PROVIDE:

1. DRAWINGS SIMILAR TO THE ABOVE
2. STRUCTURAL DETAILS OF SCREEN (WIDE RIB, CORRUGATED METAL-HORIZONTAL) IF SCREEN IS REQUIRED. SCREEN SHOULD MATCH THE COLOR OF BUILDING
3. A/C SPECIFICATIONS.

> STRUCTURAL

DESIGN REQUIREMENTS

- **SELF SUPPORTED STOREFRONTS** are required. Tenant may not support the storefront from the bulkhead, fascia, or roof deck. Structural lateral bracing support for Tenant storefronts must be from the roof joists.
- **ROOF DECK ATTACHMENT OR USE AS SUPPORT** for fixtures and equipment is not permitted.
- **HEAVY ITEMS** require structural drawings if weighing 300 lbs. or more.
- **JOIST REINFORCING** is required for roof top equipment as well as steel support for all roof openings.

> SEISMIC JOINTS

THE FOLLOWING PAGES PROVIDE REFERENCES TO THE REQUIRED SEISMIC JOINT DETAILS THAT MUST BE INCLUDED IN THE STRUCTURAL DESIGN BASED ON THE STORE LOCATION WITHIN THE CENTER.

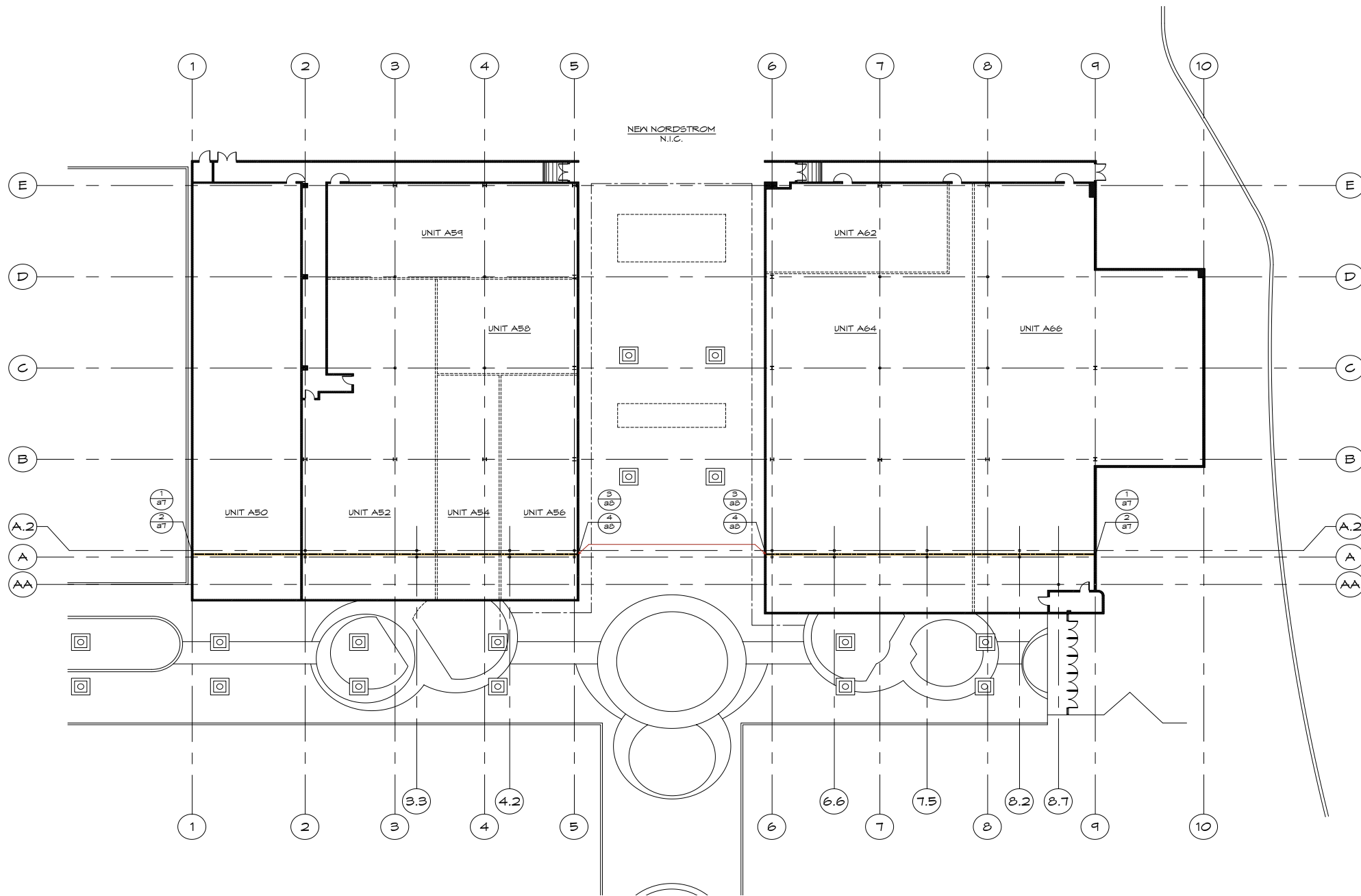

- TENANT REQUIRED SEISMIC JOINT LOCATIONS:
1. 3" EXPANSION JOINT AT TENANT'S DEMISING WALLS HALF WAY BETWEEN COLUMN GRIDS A & A.2
 2. 3" EXPANSION JOINT AT TENANT'S CEILING HALF WAY BETWEEN COLUMN GRIDS A & A.2
 3. EXPANSION JOINT AT ANY TENANT STORE-FRONT ON NORDSTROM CONCOURSE HALF WAY BETWEEN COLUMN GRID A & A.2
- "REFER TO PAGES a7 & a8 FOR SPECIFIC DETAILS TO BE USED IN THESE AREAS"

> SEISMIC JOINT DETAILS

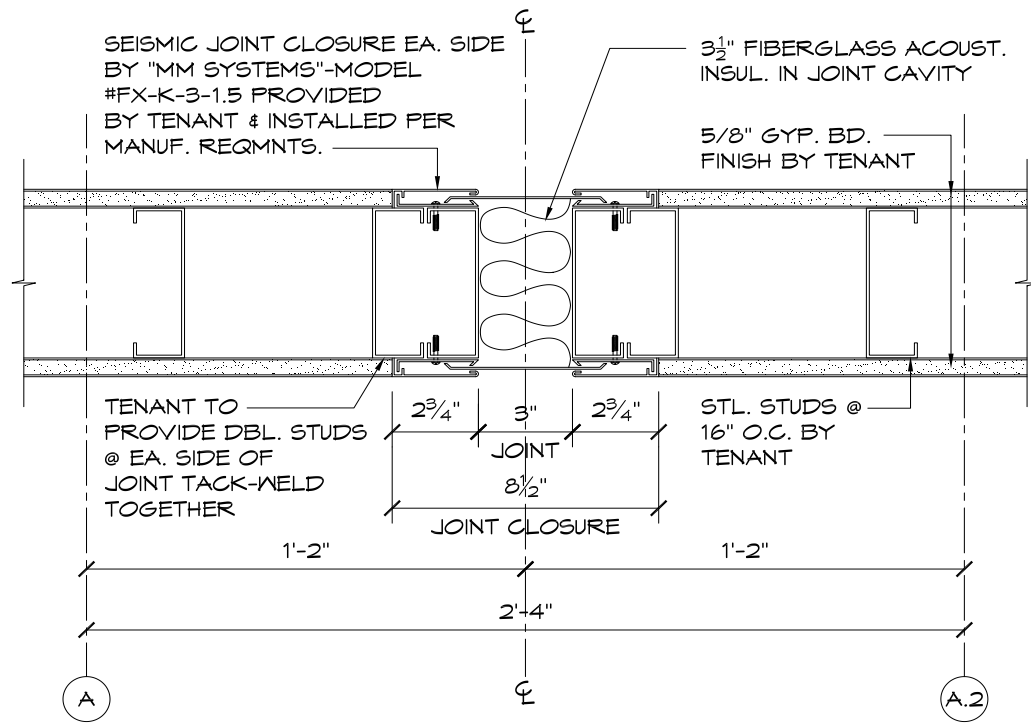

1 TENANT DEMISING WALL SEISMIC JOINT DETAIL

a7

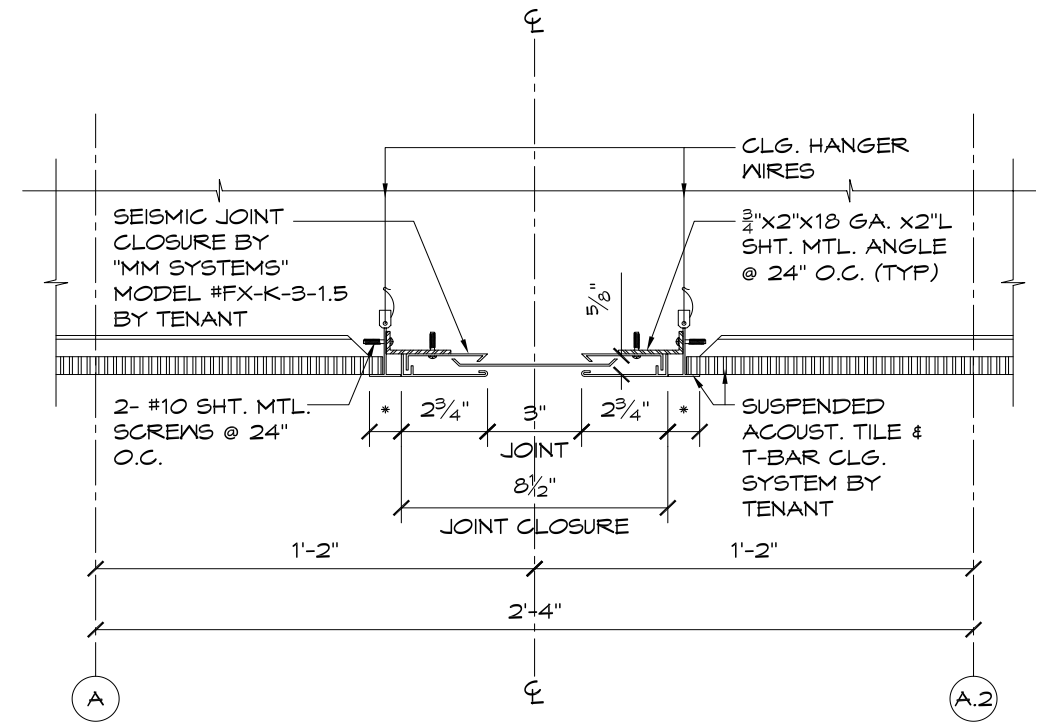

* NOTE:
T-BAR GRID WIDTH DIMENSION PER TENANT CEILING TYPE

2 TENANT CEILING SEISMIC JOINT DETAIL

a7

NOTE:
FOR A GYP. BD. CEILING, SEISMIC JOINT DETAIL WOULD BE SIMILAR TO DETAIL #1 WITH APPROPRIATE SIZED STUDS.

> SEISMIC JOINTS DETAILS

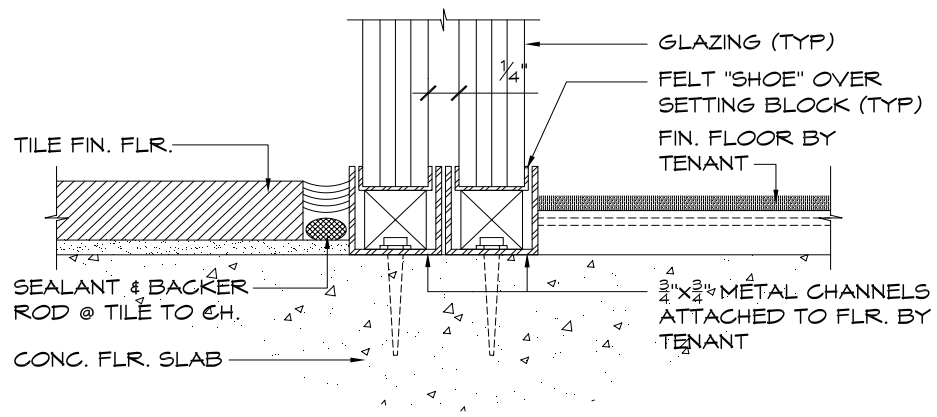

3 SECTION THRU STOREFRONT SILL @ SEISMIC JOINT
(HEAD DTL. SIMILAR)

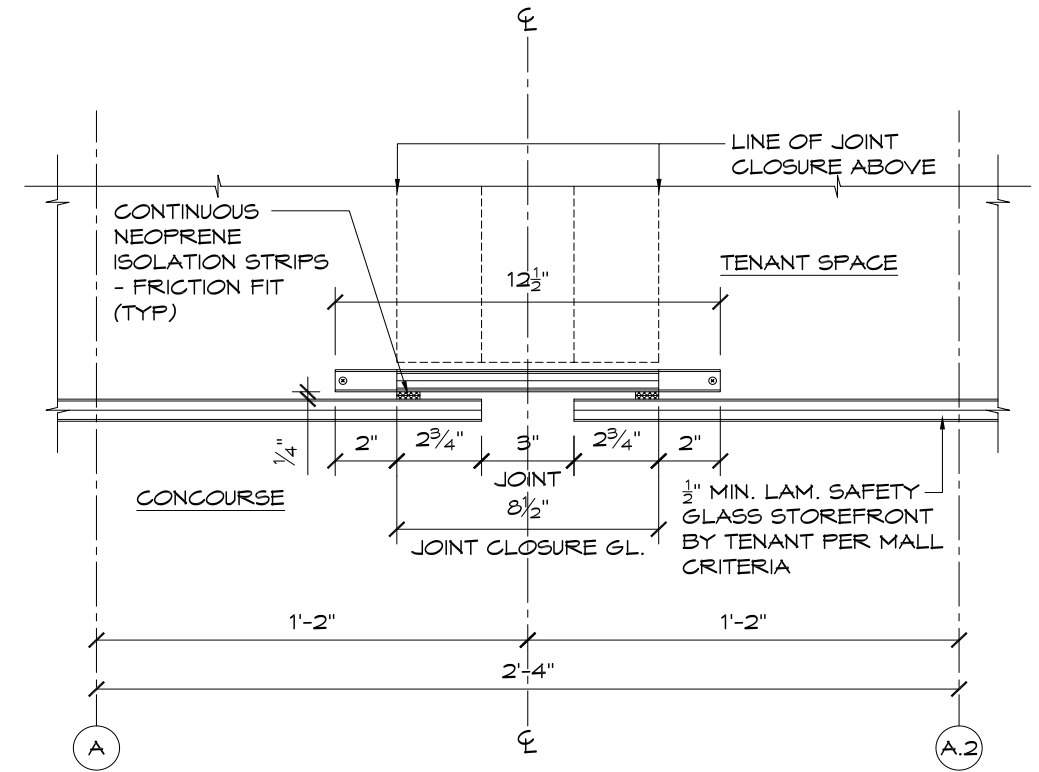

4 TENANT STOREFRONT SEISMIC JOINT PLAN DETAIL

NOTE:
 FOR SOLID MATERIAL AT STOREFRONT INSTEAD OF GLAZING,
 USE DETAIL #1

FOOD CRITERIA CONTENT OVERVIEW

2.1

FOOD COURT

DETAILS SPECIFIC DESIGN, SIGNAGE, AND TECHNICAL REQUIREMENTS FOR FOOD COURT TENANTS.

2.2

INLINE COUNTER SERVICE

DETAILS SPECIFIC DESIGN, SIGNAGE, AND TECHNICAL REQUIREMENTS FOR FOOD TENANTS WITH COMMON AREA FACING COUNTER SERVICE AND LIMITED TO NO SEATING.

2.3

RESTAURANTS

DETAILS SPECIFIC DESIGN, SIGNAGE, AND TECHNICAL REQUIREMENTS FOR FOOD TENANTS WITH INTERIOR OR EXTERIOR FACING RESTAURANT SERVICE.

SECTIONS OF INTEREST

- INLINE CRITERIA**
Standard design, technical, and sign requirements in addition to the contents in this section.
- DESIGN INSPIRATION**
Provides visual design inspirations for visual aesthetics.
- BUILDING DETAILS**
Includes property reference photos and specific storefront design details.
- PROPERTY INFO**
Includes information on the Property's building codes, area permitting, and required contractors.
- SUBMITTALS**
Outlines requirements on how and what to compile for submittals to the Landlord for design reviews.

This Food Tenant Criteria is specifically tailored to highlight unique technical and design requirements for Tenant's cooking, preparing, and selling food products.

Through the application of the Criteria guidelines, Food Tenants will produce distinctly original designs unique to their brand and the Center. These guidelines are to help maintain a consistent design quality while still allowing each Tenant to achieve a high level of expression and diversity.

The goal is to enhance the shopping experience for our Customer through the quality and artfulness of Tenant design.

This Criteria will often point to the Inline Retail Criteria as several requirements and design concepts are shared.

The Tenant's Architect is encouraged to contact the Landlord's Tenant Coordinator to discuss any specific design intentions prior to commencing design work. The Tenant Coordinator will strive to resolve all outstanding design issues. However, the Tenant Coordinator may, in the best interest of the Center, reject any aspect of the Tenant's design.

If an acceptable design cannot be agreed upon, the Landlord may, at the Tenant's expense, provide an additional concept storefront design for consideration.



> CONTENTS

FOOD COURT ZONE PLAN

DESIGN

STOREFRONT

FOOD DISPLAY & PREP / SEATING / QUEUING

LAYOUT / SERVICE COUNTER DESIGN

STOREFRONT & COUNTER MATERIALS / COUNTER ELEMENTS

LIGHTING

STOREFRONT CEILING / ROLLING GRILLE / NEUTRAL PIERS & DEMISING WALLS

INTERIOR & PREP AREAS

SIGNAGE

STOREFRONT

MENU BOARD

TECHNICAL

SECTIONS OF INTEREST

DESIGN INSPIRATION

Provides visual design inspirations for visual aesthetics.

PROPERTY INFO

Includes information on the Property's building codes, area permitting, and required contractors.

SUBMITTALS

Outlines requirements on how and what to compile for submittals to the Landlord for design reviews.

The Food Court Criteria provides key technical information and design requirements to ensure your food service enlivens the consumer experience and interfaces with the Center's food court design.

The Tenant and the Tenant's architect assume the following important obligations:

- Fulfill the intent of the Criteria both in concept and in detail.
- Determine and respond to the actual physical conditions of the Tenant's location (Zone requirements)
- Maintain and enhance the high standards of quality established in the construction of the center.
- Ensure the quality of execution of all design material, finish, and detail concepts in the construction of the Tenant's improvement.
- Provide the required detail at all transitions from Tenant storefront to neighboring storefronts, as well as to the base building.



> ZONE PLAN



SPECIFIC LOCATION DESIGN REQUIREMENTS

- Tenant lease line is flush with the face of the Landlord neutral pier.
- Tenant to install Tenant's durable floor covering within space. Tenant to install Tenant's floor covering in Tenant entry door vestibule.
- For any existing conditions at neutral piers that do not comply with the details shown for the applicable Tenant zone, it is the Tenant's responsibility to bring the adjacent neutral pier(s) into compliance per the Tenant Criteria Manual.

> ZONE DETAILS

EXISTING NEUTRAL PIERS ARE STAIR STEPPED ON THE SOUTH END OF THE FOOD COURT (AS SHOWN IN ELEVATION AND PLAN). EXISTING NEUTRAL PIERS ARE NOT STAIR STEPPED ON THE NORTH END OF THE FOOD COURT (AS SHOWN IN THE RENDERING).

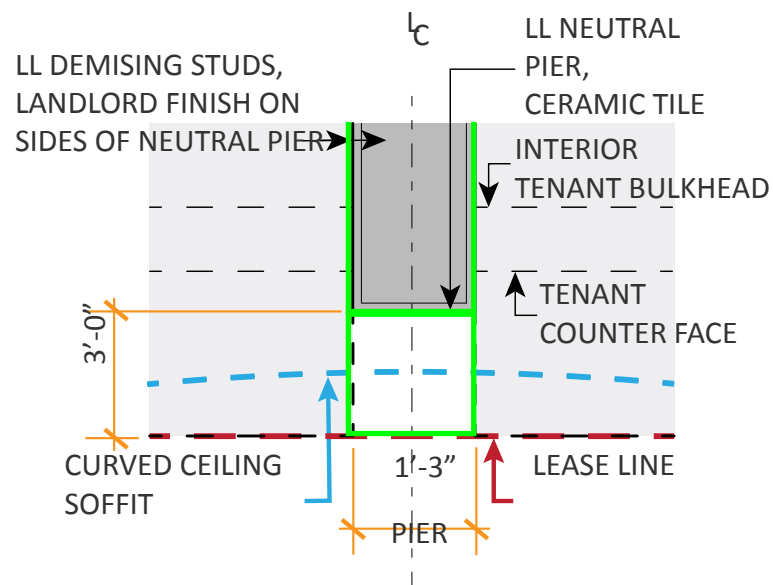
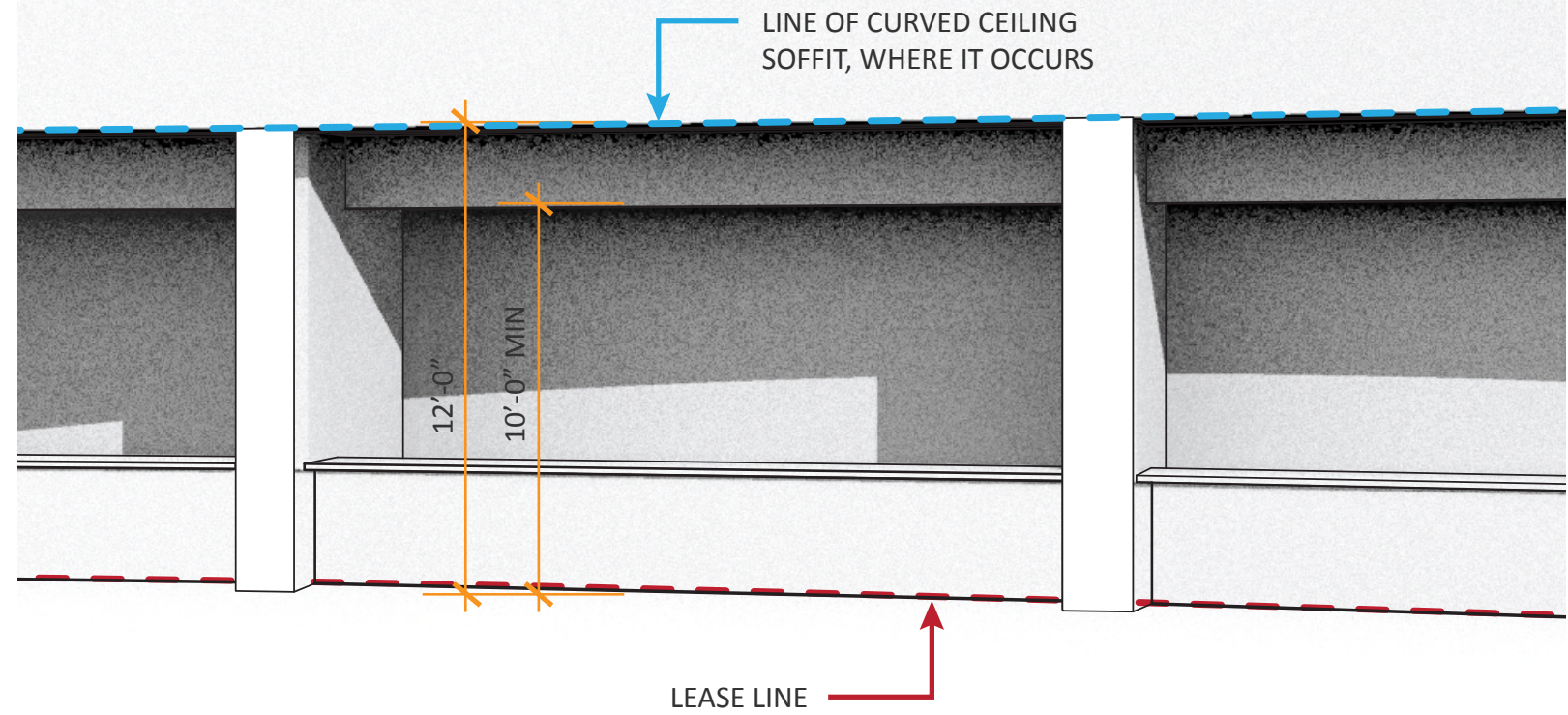
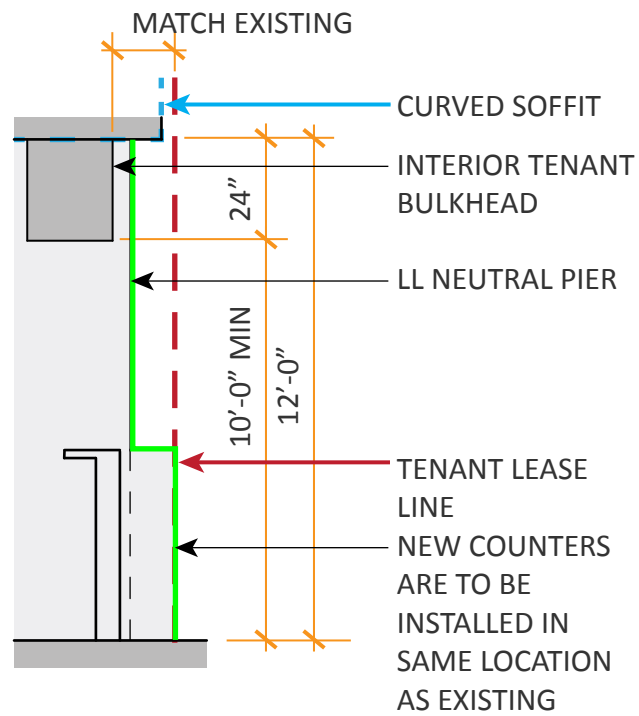

> DESIGN > STOREFRONT

Food Courts may include a variety of spaces that are comfortable and stylish, inviting the Customer to come, stay, eat, and enjoy.

The design of each unit, as viewed from the common area, must convey the unique character and sense of identity for each Tenant and also be compatible with the overall Architectural design of the Food Court.

The storefront design area considers all portions of the store that are visible to the public, in front of the full height service area partition.

Unique and unexpected storefront design will spark interest for to draw in Customers.

Encouraged storefront design traits include:

1. Use of contrast:
 - a. Mixing modern and traditional design elements.
 - b. Mixing neutrals with colors.
 - c. Blending shiny and matte surfaces.
2. Combining patterns with solids.
3. Embracing unique craft and technology.
4. Using special features, tasteful props, and displays.



> FOOD DISPLAY & PREPARATION / SEATING / QUEUING

FOOD DISPLAY

Showcases must reinforce the Tenant's image and be an integral part of the design within the counter.

Glass must be tempered or a safety type. Plexiglas is not permitted.

Showcases shall not exceed 14" above counter and 36" overall width. It shall not be more than 50% of the counter length.

FOOD PREPARATION AS THEATRE

When food preparation is visible to the public, the area is required to be designed with a sense of theater.

The need for an authentic, shared, and unique experience has grown over time. Unique experiences are the opposite of one-size-fits-all approach of the "chain". Tenants that offer a peek into the making of what they sell help include the customer and make for an authentic experience.

SEATING

- Tenants shall typically not provide, place, or install any seating, carts, etc. inside or outside the lease premises.
- Select specific areas may include private and bistro style seating. These options are site specific, so discussing early with Leasing and Tenant Coordination is recommended.

QUEUE AREAS

- All food venues must provide a queue layout that allows for the mall circulation to maintain its code minimum distances for general circulation.
- Stanchions are not allowed. Other indicator for customer directional flow will be considered.



> LAYOUT / SERVICE COUNTER DESIGN

LAYOUT

Due to the high visibility of the Customer Service Area, particular attention is given to the design review of this area. Service areas, furnishings, display cookery, food prep and cooking areas visible from the mall common area must meet strict design standards.

- Support rooms and storage shall be concealed from public view.
- A full-height partition wall must separate the Customer Service Area and Prep Area.
- Access to the Prep Area shall be via a self-closing door or between staggered “blind walls”.
- Pass-thru windows with any customer views into kitchen zone are not allowed.
- Landlord may require that any storefront setback area shall have flooring compatible in quality, color and pattern to the mall flooring material.
- All Tenant construction shall be self-supporting from the floor and structurally independent of the mall fascia and bulkhead structure. Tenant Construction may be braced horizontally/laterally to the overhead structure (not to the roof deck) within the Tenant space as depicted on Tenant plans and approved by the Landlord.

FRONT SERVICE COUNTER DESIGN

- The vertical counter face cannot be on one plane. Design must include areas that pop in and pop out to create movement. This can be achieved by recessing a small portion of the counter face by a few inches or can be more dramatic. This can also be achieved by ranging counter heights and taller vertical elements. Taller vertical elements must not block visibility.
- Counter face cannot be all one material. Must incorporate a minimum of two to three different types of material that coordinate well together.
- Vertical elements can include a plasma screen menu board or can have additional vertical signage.
- Tenant to specify a protective edge at the bottom of the counter.
- The form and materials used for counters shall be designed to be inviting to the public to help lure them to the space.
- The toe kick material must be a minimum of 3” behind the face of the counter.
- All Tenant build out must be contained within the lease line unless specifically noted in this criteria.
- Counter tops must be “Corian” or similar solid surface materials, metal or stone. Tenant counter and counter tops are to be custom designed and fabricated. Plastic laminate is prohibited.
- Plastic laminated countertops are prohibited.
- Maximum counter height is 3’-6”. Counter design, including heights, must comply with all accessibility guidelines enforced by national or local jurisdictions and the Americans with Disabilities Act.
- Sneeze guards shall be used above the front counters as required.

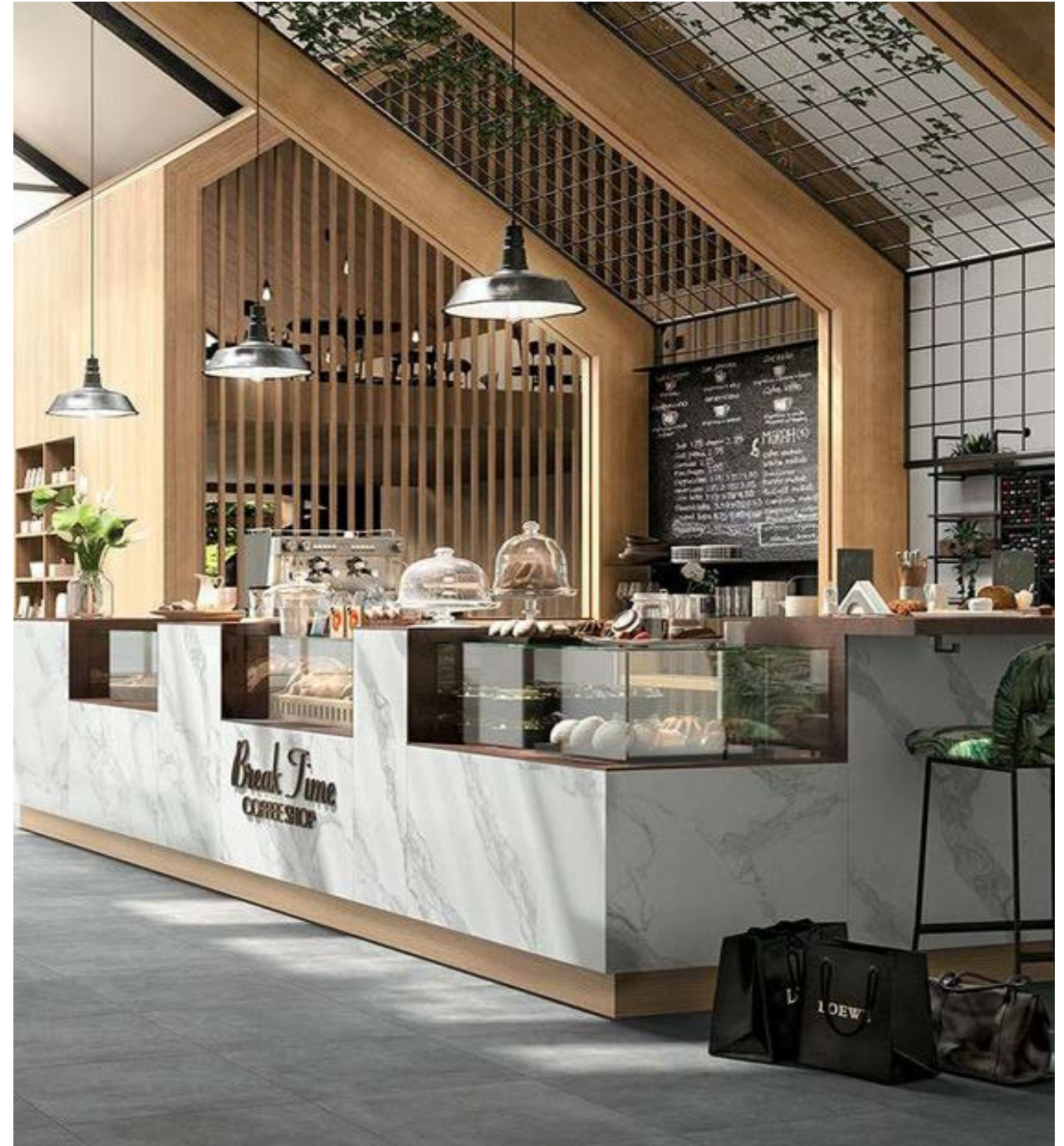

> STOREFRONT & COUNTER MATERIALS / COUNTER ELEMENTS

FRONT SERVICE COUNTER AND STOREFRONT MATERIALS

- All finish materials must be backed by a minimum 5/8" solid surface material and may include the following:
- Counter tops must be solid surface materials, metal or stone. Tenant counter and counter tops are to be custom designed and fabricated.
- All stone/tile colors must be integral throughout.
- Metal panels and architectural hardware shall have a professional and durable finish.
- Color anodized, baked painted or antique finish, (minimum of 3/8" thick), solid material, dents, dings or oil canning.
- Wood veneers and weathered or distressed wood (submit specification for approval)
- Resin panels such as 3-Form products
- Back-painted tempered glass panels
- Glass tiles
- Wood veneers

Finish materials shall NOT include the following materials:

- 4"x4", 6"x6", 12"x12" glazed tiles
- Shingles or boards
- Natural, polished or honed stone and/or porcelain tile, standard square tile design or glazed tiles
- Plastic laminate
- Faux or plastic formed brick, block or stone
- Clear anodized aluminum
- Other materials as deemed unacceptable by Landlord

COUNTERTOP ELEMENTS

- Cash registers must be recessed so that they extend no more than 9" above the counter top.
- Condiment and utensil displays or dispensers must be fully recessed into the counter.
- Fully-recessed counter-top trash receptacles (for straw wrappers, etc.) must be provided near the condiment and utensil displays.
- Tray rails, if used shall be integrated into the counter design, be contained within the lease line.
- Drink dispenser and other utilitarian kitchen equipment may not be placed on the front counter.



> LIGHTING

LIGHTING

Tenants must light both their storefront as well as the countertop.

Lighting on architectural elements and menu boards are also required.

- Tenant is responsible for all lighting within the entire demised premises.
- Foot-candle levels at counter height shall be 50 FC average maintained.
- The use of decorative lighting such as luminous ceilings, chandeliers, pendant, wall units or clear type glitter strips are permitted if the location is approved by Landlord.
- No lighting shall be installed outside the demised premises.
- All Tenant lighting shall be controlled separately, and illuminated during mall hours.
- If incandescent quartz halogen lighting is used, Tenant shall provide specifications with submittal.
- To retain and protect the visual environment of the area and for the benefit of all Tenants, each individual Tenant shall limit the brightness of their lighting fixtures, which shall be subject to the Tenant Coordinator's approval.
- Emergency lighting must be fully recessed in the front-of house, (sales) areas. No surface mount type is allowed.
- No track lighting is permitted in the front of house area unless specifically approved by Landlord. It can be used if it is hidden or recessed into ceiling, otherwise Tenant should use mono-point type fixtures.
- Use of high quality fixtures is required. Submit cut sheets of fixtures including manufacturer, model and any photos of specific fixture to Landlord for design approval.
- Use staggered under counter lighting for an even distribution of light.
- Vertical storefront surfaces must be lit.
- Bottom of pendant light to be at 6'-8" minimum, a.f.f. installed

Recommended lighting approaches include but are not limited to:

- Pendant fixtures that are suspended by cord, cables or chain with uplight and/or downlight components.
- Recessed downlights
- Surface mounted high-tech, high quality, low profile and decorative fixtures
- Indirect ceiling cove lighting system using linear incandescent lamps, neon or florescent lamps.

Unacceptable lighting approaches include but are not limited to:

- H.I.D. lighting unless approved by the Architect and the shielding is specified in submittal.
- Direct visual exposure of incandescent lamps and/or fluorescent tubes.
- Acrylic or plastic lensed fixtures, or bare lamps
- Fluorescent fixtures
- Track light fixtures
- Strobe moving or fiber optic lights
- Floor-mounted fixtures

To create a consistent theme of lighting and appetizing color, lamp or "bulb" requirements must be adhered to as follows:

- No linear T-5, T-8 or T-12 fluorescent lamps are allowed, unless specifically installed in a ceiling cove where the lamp is not visible.



> STOREFRONT CEILING / GRILLE / NEUTRAL PIERS & WALLS

STOREFRONT CEILING

- Suspended ceiling of gypsum board, (hard lid), is required in customer areas. See specific zone area for additional requirements.
- Tenant must provide a reflected ceiling plan indicating any and all Tenant lighting, suspended design elements and signage for Landlord approval.
- Ceiling access panels, where required must be depicted on the Tenant's plans, approved by Landlord and be provided at Tenant's expense.
- Allow for access to all structural mechanical, plumbing, electrical, telephone and fire protection systems including all junction boxes, switches, valves, etc. and other equipment for purposes of servicing, and maintaining this infrastructure.

ROLLING GRILLES

Rolling grilles are not allowed.

NEUTRAL PIERS AND DEMISING WALLS

The Customer Service Area shall address the full opening width, abutting the Neutral Walls and Neutral Knee Walls on each side of the leased space and extending full height to the Mall soffit.

- Mall structural columns, excluding those treated as neutral piers, located either within the Storefront Zone or along the store frontage, must be integrated into the store design unless otherwise directed by Landlord.
- Special condition neutral walls may be low and extend back from the face of the lease line. This condition increases visibility into the store, however, it requires close coordination with the Tenant Coordinator in the design process.



> INTERIOR AND PREP AREA

Kitchen areas, storage, dish areas, and any other areas not visible to the public must meet the following design requirements:

LIGHTING

Lighting may include, but is not limited to:

- 2'x4' lay-in surface-mounted fluorescent light fixtures.
- Any fixture allowed by code necessary for food preparation.

FLOORING

The entire Lease Premises shall be completely and properly sealed using a 'Dex-o-tex' NEOBOND II Fracture Resistant Membrane Waterproofing or equal membrane type sealer approved by Landlord, prior to the installation of any finished flooring material.

The membrane must be turned up all perimeter storefront walls, counters and surfaces a minimum of 24", to protect the adjacent Tenants and Mall common areas. Then, either FRP (prep area only), or tile is to be installed up to at least 4'.

Tenant to submit detail to Landlord for approval prior to installation.

Tenant shall furnish and install floor tile over waterproof membrane throughout the entire premises.

The finished floor must be sloped to the Tenant installed floor drains.

Allowed flooring materials include:

- Quarry tile
- Porcelain ceramic tile

Prohibited flooring materials include:

- Vinyl
- Glazed ceramic tile
- Carpet
- Any other material deemed unsuitable by the Landlord

CEILING

2'x4' drop-in panels with an approved finish shall be permitted in storage areas so long as they are not visible to the customers.

WALLS

All walls in the Prep Area must be of a durable, non-porous, washable surface as required by health codes.

EXIT DOORS

All exit door specifications, hardware, door handles, recess dimensions, etc. shall be per Landlord criteria and conform to local codes and ordinances.



> SIGNAGE > STOREFRONT

Food Court Tenant's primary storefront sign must be creative, imaginative and incorporated into the overall storefront design.

- Sign must be proportional to overall elevation. Landlord will review sign size on an individual basis. Sign length must not be more than 1/3 of the overall storefront length.
- Sign must complement overall design and add visual interest.
- Power must be concealed.
- 12" max letter height will be enforced.
- Back of sign must be finished.



> MENU BOARDS

Menu board applications must be a part of the overall store design. We strongly encourage using a graphic designer to create your boards.

The following requirements must be when designing your menu boards:

- All menu boards must be submitted to the Landlord for review and approval prior to start of Tenant construction.
- Professional quality drawings/renderings must be submitted for approval.
- Design shall be an integral part of the graphics and complimentary to primary signage character.
- Overall width of menu board cannot exceed 60% of overall storefront width.
- Mounting height to be a minimum of 7'-0" to bottom of sign with maximum height of 10'-0" and held a minimum of 10" from edge of walls.
- The menu board must be non-reflective to avoid glare.

Permitted menu board design elements include:

- Artisan type quality such as chalkboards, painted wood or unusual materials and combinations of material.
- Frames, holders, text, photo displays, lighting and materials must be creatively designed.
- High quality digital print outs for menu board may be approved at Landlord's discretion.
 - Photographs used in menu boards must be professionally produced and approved by the Landlord.
- Externally illuminated menu boards are allowed.
 - Tenant is required to submit light fixture cut sheet for approval.

Not permitted menu board design elements include:

- Standard factory designs.
- Standard surface-mounted box-type internally illuminated menu boards are not permitted or, this type of menu board is to be recessed into back wall.



> TECHNICAL

Food Court Tenants must adhere to the technical requirements found in the Inline Technical section linked here: [INLINE TECHNICAL CRITERIA](#)

In addition to the requirements detailed in the Technical Criteria, Tenants cooking food in their space must adhere to the following:

GENERAL REQUIREMENTS

- **KITCHEN SINKS** including pot sinks, scullery sinks, pre-wash sinks and other kitchen units must be connected to a grease trap.
- **DISHWASHERS** may not be connected to grease trap.
- **GREASE INTERCEPTOR** must be designed and approved by Landlord prior to installation, especially if located outside the lease line.
- **OIL COLLECTION AND HAULING SYSTEM** is required for Tenants with fryers or other grease/oil generating equipment that does not run through an interceptor. Landlord does not provide a centralized collection point.
- **BACKFLOW PREVENTERS** are required for food service, hair salons or other Tenants with equipment or operations that have the possibility of backflow. These must be certified and acceptable to the water district and checked yearly or as required by the local authority having jurisdiction.

KITCHEN EXHAUST REQUIREMENTS

- **LANDLORD REVIEW** is required to ensure the exhaust does not compromise the ventilation air of adjacent mall roof top units.
- **GREASE EXHAUST** must be provided on all exhaust blowers. Supreme Heavy Duty GBD Exhaust Blowers are required for all kitchen exhaust or grease laden air removal.

FUMES AND ODORS

The following constitutes the minimum requirements for special exhaust systems which Tenant must furnish and install in the Leased Premises for the elimination of fumes and odors due to Tenant operations:

- A separate exhaust system must be provided and installed which will generate negative pressure in the Leased Premises as outlined below.
- A total negative pressure of between five and ten percent (5-10%) must be maintained during all hours that Tenant is operating its business in the Leased Premises.
- The HVAC system must be modified to provide additional make-up supply air to offset the quantity of air exhausted.
- The Tenant must have a certified air balancing contractor test the completed system and verify its operation according to these specifications. A copy of the air balancing report must be submitted to the Mall General Manager for review and approval prior to opening for business.
- The combined HVAC and exhaust system per the above-noted specifications must be in operation during all hours that Tenant is operating its business in the Leased Premises.
- The combined HVAC system must be connected to the Landlord EMS by the Landlord required contractor. See the Technical Criteria section for specifics.
- Indoor tenants which will be using any type of gas, liquid or solid fuel for heating, cooking or other use, must have an active carbon monoxide detector installed. The type should be and Hardwire Interconnectable 120- Volt Carbon Monoxide Alarm with Digital Display and Battery Backup.
- Carbon dioxide detection is required if tenant has a carbon dioxide systems with 100 lbs. or more of carbon dioxide used in their beverage dispensing applications.



STRUCTURAL

The structure or sub-structure that supports any new or replacement HVAC unit, transformer, other heavy equipment or modification of any structure or substructure, shall be designed, engineered and installed at Tenant's sole cost and expense.

Tenant shall provide structural engineering calculations and drawings from a licensed structural engineer (Registered in the State of the Center where the work is located) to Landlord for review and approval prior to installation of any such items or equipment.

All equipment is to be installed over structural members that can support the weight of the equipment in areas designated by Landlord.

All recommendations of design and verification of completion shall include the structural engineer's embossed seal from the state.

ELECTRICAL

An empty, separate meter socket will be stubbed to the Tenant premises from the Mall electrical room.

NATURAL GAS

All new development and newly tenanted restaurants need to have seismic gas shut-off valves installed on Landlord side of the meter, at each individual space.

Seismic valves must be:

- UL-approved, FM-approved or, ACSE 25-compliant.
- All devices must be installed consistent with manufacturer's instructions and following jurisdictional code.

Natural Gas service is available for Tenants to obtain. Tenants will be responsible for obtaining gas service from the gas company. Gas is permitted for cooking equipment only, not for HVAC.

POTABLE WATER

A single water stub-in will be supplied by the Landlord to each Tenant space.

SANITARY WASTE

A 4" sanitary waste line shall be stubbed below each Tenant space by Landlord. Tenant shall route their own vent lines to a point above the roof.

GREASE WASTE

Tenant shall route their own vent lines to a point above the roof. Vents and ductwork are to be cleaned by tenants on a regular basis to avoid fires from grease build up. Tenant must provide their own grease interceptors.

FIRE PROTECTION / SPRINKLER SYSTEM

Tenants must use the Mall's required sprinkler contractor as well as connect to the Landlord's fire alarm system, using the Landlord required fire alarm contractor.

> CONTENTS

❑ DESIGN

- ❑ *PREP & FOOD DISPLAY / QUEUE / LAYOUT*
- ❑ *COUNTER DESIGN / COUNTER ELEMENTS*
- ❑ *MATERIALS / LIGHTING / FLOORING*

❑ SIGNAGE

- ❑ *PRIMARY SIGNAGE / MENU BOARDS*

❑ TECHNICAL

SECTIONS OF INTEREST

❑ *INLINE CRITERIA*

Includes standard design, technical, and sign requirements in addition to the contents in this section.

❑ *DESIGN INSPIRATION*

Provides visual design inspirations for visual aesthetics.

❑ *BUILDING DETAILS*

Includes property reference photos and specific storefront design details.

❑ *PROPERTY INFO*

Includes information on the Property's building codes, area permitting, and required contractors.

❑ *SUBMITTALS*

Outlines requirements on how and what to compile for submittals to the Landlord for design reviews.

The Inline Food Counter Service Criteria provides key technical information and design requirements to ensure your common area facing counter food service enlivens the consumer experience and interfaces with the Center.

This criteria will often point to the Inline Retail Criteria as several requirements and design concepts are shared. The content in this section highlights the unique concepts for food service design.

The Tenant and the Tenant's Architect assume the following important obligations:

- Fulfill the intent of the criteria both in concept and in detail.
- Determine and respond to the actual physical conditions of the Tenant's location (Zone requirements)
- Maintain and enhance the high standards of quality established in the construction of the center.
- Ensure the quality of execution of all design material, finish, and detail concepts in the construction of the Tenant's improvement.
- Provide the required detail at all transitions from Tenant storefront to neighboring storefronts, as well as to the base building.



> DESIGN > PREP & FOOD DISPLAY / QUEUE / LAYOUT

Inline and Restaurant Food Tenants must adhere to the design requirements found in the Inline Design section linked here: [INLINE DESIGN CRITERIA](#)

In addition to the requirements detailed in the Design Criteria, Tenants serving food in their space must adhere to the following design requirements:

PREPARATION AS THEATER

Tenant's offering a peek into the making of food, by nature, include the customer and make for an authentic experience. This inclusion of the customer will increase engagement and is highly encouraged.

FOOD DISPLAY

When displaying food, the following requirements must be followed:

Showcases must reinforce the Tenant's image and be an integral part of the design within the counter.

Glass must be tempered or a safety type. Plexiglas is not permitted.

Showcases shall not exceed 14" above counter and 36" overall width. It shall not be more than 50% of the counter length.

QUEUE AREAS

All food venues must provide a queue layout that allows for the mall circulation to maintain its code minimum distances for general circulation.

Stanchions are not allowed. Other indicator for customer directional flow will be considered.

LAYOUT

Due to the high visibility of the Customer Service Area particular attention is given to the design review of this area. Service areas, furnishings, display cookery, food prep and cooking areas visible from the mall common area must meet strict design standards.

- Support rooms and storage shall be concealed from public view.
- A full-height partition wall must separate the Customer Service Area and Prep Area.
- Access to the Prep Area shall be via a self-closing door or between staggered "blind walls".



> COUNTER DESIGN / COUNTER ELEMENTS

FRONT SERVICE COUNTER DESIGN

- The form and materials used for counters shall be designed to be inviting to the public to help lure them to the space.
- Tenant to specify a protective edge at the bottom of the counter.
- Counter tops must be “Corian” or similar solid surface materials, metal or stone. Tenant counter and counter tops are to be custom designed and fabricated. Plastic laminate is prohibited.
- Plastic laminated countertops are prohibited.
- Maximum counter height is 3’-6”. Counter design, including heights, must comply with all accessibility guidelines enforced by national or local jurisdictions and the Americans with Disabilities Act.
- Sneeze guards shall be used above the front counters as required.

COUNTERTOP ELEMENTS

- Cash registers must be recessed so that they extend no more than 9” above the counter top.
- Condiment and utensil displays or dispensers must be fully recessed into the counter.
- Fully-recessed counter-top trash receptacles (for straw wrappers, etc.) must be provided near the condiment and utensil displays.
- Drink dispenser and other utilitarian kitchen equipment may not be placed on the front counter.



> MATERIALS / LIGHTING / FLOORING

FRONT SERVICE COUNTER AND STOREFRONT MATERIALS

All finish materials must be backed by a minimum 5/8" solid surface material and may include the following:

- Counter tops must be solid surface materials, metal or stone. Tenant counter and counter tops are to be custom designed and fabricated.
- All stone/tile colors must be integral throughout.
- Metal panels and architectural hardware shall have a professional and durable finish.
- Color anodized, baked painted or antique finish, (minimum of 3/8" thick), solid material, dents, dings or oil canning.
- Wood veneers and weathered or distressed wood (submit specification for approval)
- Resin panels such as 3-Form products
- Back-painted tempered glass panels
- Glass tiles
- Wood veneers

Finish materials shall NOT include the following materials:

- 4"x4", 6"x6", 12"x12" glazed tiles
- Shingles or boards
- Natural, polished or honed stone and/or porcelain tile, standard square tile design or glazed tiles
- Plastic laminate
- Faux or plastic formed brick, block or stone
- Clear anodized aluminum
- Other materials as deemed unacceptable by Landlord.

LIGHTING

Tenants must light both their storefront as well as the countertop. Lighting on architectural elements and menu boards are required.

FLOORING

All "wet" area must install a water proof membrane that is tested and confirmed by the Landlord. Full requirements can be found in the plumbing section of the [INLINE TECHNICAL CRITERIA](#).



> SIGNAGE > PRIMARY / MENU BOARDS

PRIMARY STOREFRONT SIGN

Inline and Restaurant Food Tenants must adhere to the signage requirements found in the [INLINE SIGNAGE CRITERIA](#)

MENU BOARDS

Inline and Restaurant Food Tenants must adhere to the menu board requirements found in the [FOOD COURT SIGN CRITERIA](#)

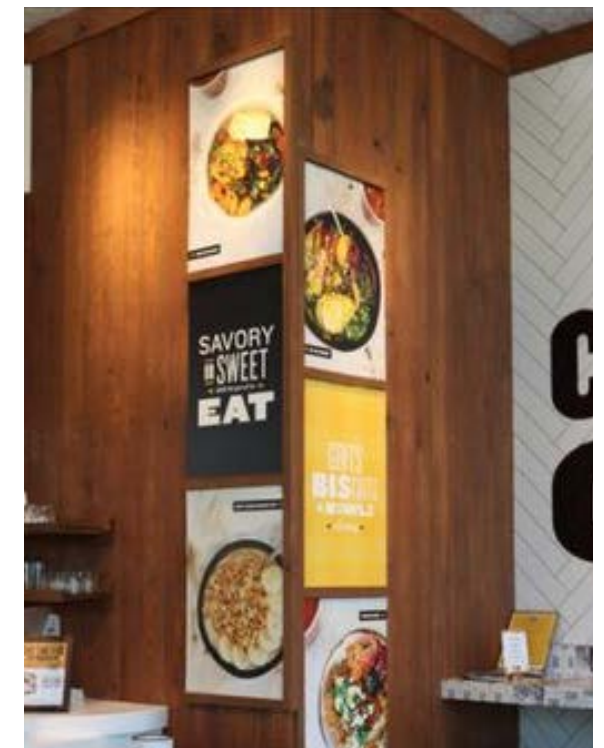

> TECHNICAL

Inline and Restaurant Food Tenants must adhere to the technical requirements found in the Inline Technical section linked here: [INLINE TECHNICAL CRITERIA](#)

In addition to the requirements detailed in the Technical Criteria, Tenants cooking food in their space must adhere to the following:

GENERAL REQUIREMENTS

KITCHEN SINKS including pot sinks, scullery sinks, pre-wash sinks and other kitchen units must be connected to a grease trap.

DISHWASHERS may not be connected to grease trap.

GREASE INTERCEPTOR must be designed and approved by Landlord prior to installation, especially if located outside the lease line.

OIL COLLECTION AND HAULING SYSTEM is required for Tenants with fryers or other grease/oil generating equipment that does not run through an interceptor. Landlord does not provide a centralized collection point.

BACKFLOW PREVENTERS are required for food service, hair salons or other Tenants with equipment or operations that have the possibility of backflow. These must be certified and acceptable to the water district and checked yearly or as required by the local authority having jurisdiction.

KITCHEN EXHAUST REQUIREMENTS

LANDLORD REVIEW is required to ensure the exhaust does not compromise the ventilation air of adjacent mall roof top units.

EXHAUST FAN must be a SWSI centrifugal fan which must be fitted with a minimum 10'-0" stainless steel upblast. Guy wires must be attached to the roof in order to secure the stack. Use the mall roofer for connection of the guy wires at Tenant's expense.

GREASE GUARD CONTAINMENT SYSTEM (or approved equal) must be installed to protect the Landlord's roof. A quarterly maintenance program must be in-place for the grease containment units. Proof of the maintenance contract must be presented to Operations Manager prior to the store opening.

RESTAURANT SPECIFIC REQUIREMENTS

PLANS MUST SHOW sizes and locations for all duct and piping through roof as well as all required fireproofing.

CONTAIN ALL GARBAGE AND REFUSE AREAS WASH DOWN "grey" water and properly drain off into city approved system (i.e. sewer or storm).

FOOD PREP AND BAKING ON SITE REQUIREMENTS

INSTALL DRY CHEMICAL EXTINGUISHING DEVICES (such as Ansul) approved by the fire insurance rating organization carriers.

MAINTAIN ALL EXHAUST DUCTS AND FILTERS in a clean condition. Ducts are to be professionally cleaned on a regular basis to help prevent grease fires.

GARBAGE AND REFUSE MUST BE PLACED IN CONTAINERS which shall be kept, until collected, in a self-contained area within the demised premises set aside for the storage of garbage and/or storing of inflammable or combustible materials, Tenant agrees to install and maintain appropriate chemical extinguishing devices.

FAILURE TO INSTALL REQUIRED EQUIPMENT referred to in this section and/or to subscribe to the servicing thereof, Landlord shall have the right to enter the demised premises and to make any necessary installations and charge the cost of such installations and/or the servicing thereof to Tenant which Tenant agrees to pay to Landlord, as additional rent, within ten (10) days after demand.

GAS UTILITY

Gas may be available at the Center for cooking applications. If available, Tenant, at its sole cost and expense and in compliance with local code must procure gas service to and within the demised premises and will make all necessary arrangements with the local Gas Company for such service.

SERVICE REQUIREMENTS

GAS METER INSTALLATION at gas meter header is the responsibility of the Tenant.

GAS PIPING INSTALLATION, when allowed, is the responsibility of the Tenant to provide and install. Roof piping must be placed on pillow blocks or similar arrangement. All roof repairs to be by the Landlord's required roofer at Tenant's expense.

PRESSURE REGULATORS required for connection to Tenant's equipment is the responsibility of the Tenant. Coordinate with Landlord for regulator vent routing.

SEISMIC AND MANUAL SHUTOFF DEVICES are required for the entire gas piping system and equipment or fixtures and color coded or identified as such as required. Seismic valves must be: UL- approved; FM-approved; or, ACSE 25-compliant. All new development and newly tenanted restaurants need to have seismic gas shut-off valves installed on Landlord side of the meter, at each individual space.

> CONTENTS

☐ DESIGN

☐ *STOREFRONT / PREPARATION AS THEATER*

☐ *CONTROL AREAS / SEATING*

☐ *EXTERIOR*

☐ SIGNAGE

☐ *STOREFRONT / MENU BOARDS*

☐ TECHNICAL

SECTIONS OF INTEREST

☐ *INLINE CRITERIA*

Includes standard design, technical, and sign requirements in addition to the contents in this section.

☐ *DESIGN INSPIRATION*

Provides visual design inspirations for visual aesthetics.

☐ *BUILDING DETAILS*

Includes property reference photos and specific storefront design details.

☐ *PROPERTY INFO*

Includes information on the Property's building codes, area permitting, and required contractors.

☐ *SUBMITTALS*

Outlines requirements on how and what to compile for submittals to the Landlord for design reviews.

The Restaurant Criteria provides key technical information and design requirements to ensure your interior or exterior facing restaurant food service enlivens the consumer experience and interfaces with the Center.

This criteria will often point to the Inline Retail Criteria as several requirements and design concepts are shared. The content in this section highlights the unique concepts for food service design.

The Tenant and the Tenant's Architect assume the following important obligations:

- Fulfill the intent of the criteria both in concept and in detail.
- Determine and respond to the actual physical conditions of the Tenant's location (Zone requirements)
- Maintain and enhance the high standards of quality established in the construction of the center.
- Ensure the quality of execution of all design material, finish, and detail concepts in the construction of the Tenant's improvement.
- Provide the required detail at all transitions from Tenant storefront to neighboring storefronts, as well as to the base building.



> DESIGN > STOREFRONT / PREPARATION AS THEATER

Restaurant Food Tenants must adhere to the design requirements found in the Inline Design section linked here: [DESIGN CRITERIA](#)

In addition to the requirements detailed in the Design Criteria, Tenants serving food in their space must adhere to the following design requirements:

GENERAL STOREFRONT AND DESIGN

Restaurant storefronts will be subject to the general storefront criteria in this manual, for both design and technical requirements.

Restaurants may face both the interior and the exterior, and are often located adjacent to a mall entry. The exterior and the interior are subject to different criteria standards, both for presentation and signage.

Interior restaurants oftentimes have a waiting area within the common space.

- If needed these must be shown in the submissions and be approved by Landlord. They must be coordinated with common area needs and code requirements.

We encourage a cohesive presentation of the brand within the context of the whole mall design, while the individual brand is important and the two must harmonize. Design should be tailored to its location both within the community and the whole Center's aesthetics.

PREPARATION AS THEATER

Tenant's offering a peek into the making of food, by nature, include the customer and make for an authentic experience. This inclusion of the customer will increase engagement and is highly encouraged.



> CONTROL AREAS / SEATING

CONTROL AREAS

The DCA is the area at the front of the Tenant space that extends from the Lease Line to all points 6'-0" into the space. It should convey excitement and give the consumer a reason to engage.

Exposed patios are encouraged however, they should not extend beyond the lease line. In special cases there may be opportunity to extend the patio but it must be in compliance with all common mall code and circulation requirements.

Projection or canopies may increase the visibility of the storefront over seating areas. They also help with lighting the storefront.

In addition to the general DCA criteria for inline stores the following requirements must be met:

- All patio rails, reception podiums, waiting areas, menu presentations, lighting, heating, visible banquet detailing, and material palettes must be presented for review and approval.
- Common mall flooring must be maintained. Coordinate with Landlord design if railings or other elements will have an effect on the flooring.

SEATING

Where interior seating is needed or desired, it is suggested that the enclosure line be moved into the lease space by approximately 12 feet.

In some cases options for furniture may be supplied by the mall design team for the tenant to choose from. Refer to the Zone Plan for your location found in the linked: BUILDING DETAILS SECTION.

Seating design requirements include:

- Patio seating must be separated from the common area circulation in the Mall. A layout will be required for review.
- All visible furniture must be reviewed by the Landlord for suitability both aesthetically, as well as for performance specifications.
- Tenant is responsible to confirm additional requirements with the local authorities for any railing or barrier for the Tenant's proposed area.



> EXTERIOR

Restaurants with exterior storefronts will be subject to the general criteria in this manual, for aesthetics.

Exterior design should be tailored to its location both within the community as well as the whole Mall and its aesthetics.

SITE PLANS

- A Site Plan must be submitted that includes all required calculations for GLA, GBA, and parking requirements.
- Site Circulation must be included showing the adjacent intersections, driveways, drive directions, and dimensions of all access points.
- Photos of adjacent and onsite conditions may be required by ownership for the review process.

AMENITIES

- Planters, heat lamps, tables, chairs etc., must be submitted for approval. All amenities must be commercial grade and suitable for outdoor use.
- Pendant or sconce lighting must be submitted for approval by Landlord.
 - Lighting plans of canopies and trellis are available in Landlord supplied base drawings.
- Umbrellas are only allowed in the designated areas and cannot overhang into the public right-of-way.
 - Umbrellas should be small in scale (maximum 6'-0" in diameter) and no more than 9'-0" high at the peak.
 - Wood or metal are the only acceptable materials for the umbrella structure. No insignia, graphics or text are permitted on the umbrella fabric.
 - The umbrella fabric must be flame retardant material in a color approved by Landlord's Tenant Coordinator.

EXTERIOR PATIOS

- Any changes to an existing patio must be approved by Landlord. Tenant is responsible to confirm the requirements with the local municipality for proposed use.
- Temporary elements such as greeting stands, waiting areas must be submitted for review.
- Confirm code height and density of railings for of any necessary barriers.
- Patio layouts with adjacent circulation dimensioned must be included in the first submittal of documents for design review.
- Railing design details should be submitted with the concept and construction packages for approval by the Landlord design team.



> SIGNAGE > PRIMARY / MENU BOARDS

PRIMARY STOREFRONT SIGN

Inline and Restaurant Food Tenants must adhere to the signage requirements found in the Inline Signage section linked here: [SIGN CRITERIA](#)

Exterior signage must adhere to the requirements established by the local municipality. Specific requirements can be found in the Addendum linked here: [ADDENDUM](#)

MENU BOARDS

Inline and Restaurant Food Tenants must adhere to the menu board requirements found in the Food Court Signage section linked here: [FOOD COURT SIGN CRITERIA](#)





> TECHNICAL

Inline and Restaurant Food Tenants must adhere to the technical requirements found in the Inline Technical section linked here: [TECHNICAL CRITERIA](#)

In addition to the requirements detailed in the Technical Criteria, Tenants cooking food in their space must adhere to the same requirements found in the Inline Counter Service Technical section linked here: [INLINE COUNTER SERVICE TECHNICAL CRITERIA](#)

MALL ZONES > OVERVIEW MAP

This section provides storefront design details, requirements, and visual references specific to the six primary zones located within Los Cerritos Center. These are additional design requirements that must be followed to ensure your store correctly interfaces with the immediate surroundings. Click or tap on a colored Zone to navigate directly to that Zone's details.



Click or tap on a colored Zone to view that Zone's construction details.

ZONE 1 CRITERIA



ZONE 1 REQUIREMENTS

- Required storefront height is 17'-6" with a 6" wide reveal above, finished to complement tenant storefront.
- Tenant lease line is located 9" from face of Landlord neutral pier. (VIF) Lease line is flush with bulkhead above.
- 1'-0" max storefront projection above 10'-0" AFF is required in all areas except the no-popout zone. (See No-Popout Zone Plan image above) Verify exact location of No Popout Zone with Tenant Coordinator
- A projecting element is required between 10'-0" to 17'-6" AFF. The design intend is not to have the entire area project out but to create a zone specifying where some sort of projection would be allowed. Consult with Tenant Coordinator regarding this requirement. The design objective is to create movement and interest by popping-out/popping-in. The storefront cannot be on one plane, except if in No-Popout Zone.
- Entry width shall be no greater than 8'-0". Closure shall be by swing type doors recessed at least 3'-0" in depth from face of storefront.
- Tenants in this zone will specify and install floor finishes to lease line.
- **Special Condition: Tenants immediately adjacent to Nordstrom cannot have their storefront bulkhead pop-out the additional 2'-0" as noted in the standard details. Please contact your Tenant Coordinator for additional details and with any questions.
- For any existing conditions at neutral piers that do not comply with the details shown for the applicable Tenant zone, it is the Tenant's responsibility to bring the adjacent neutral pier(s) into compliance per the Tenant Criteria Manual.
- Neutral pier paint will be provided by the Mall Property Team for consistency with existing conditions.
- Height to deck in some areas of this zone is 40'-0". Field verify.

ZONE 1 DETAILS

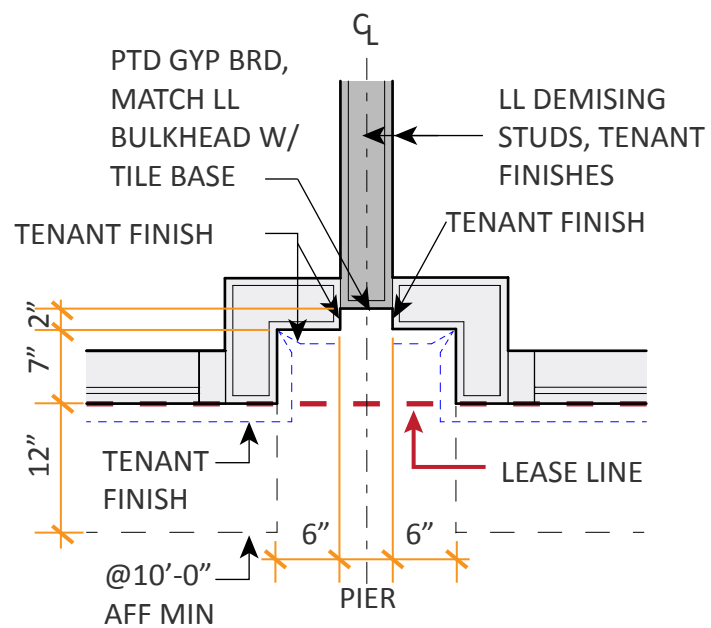
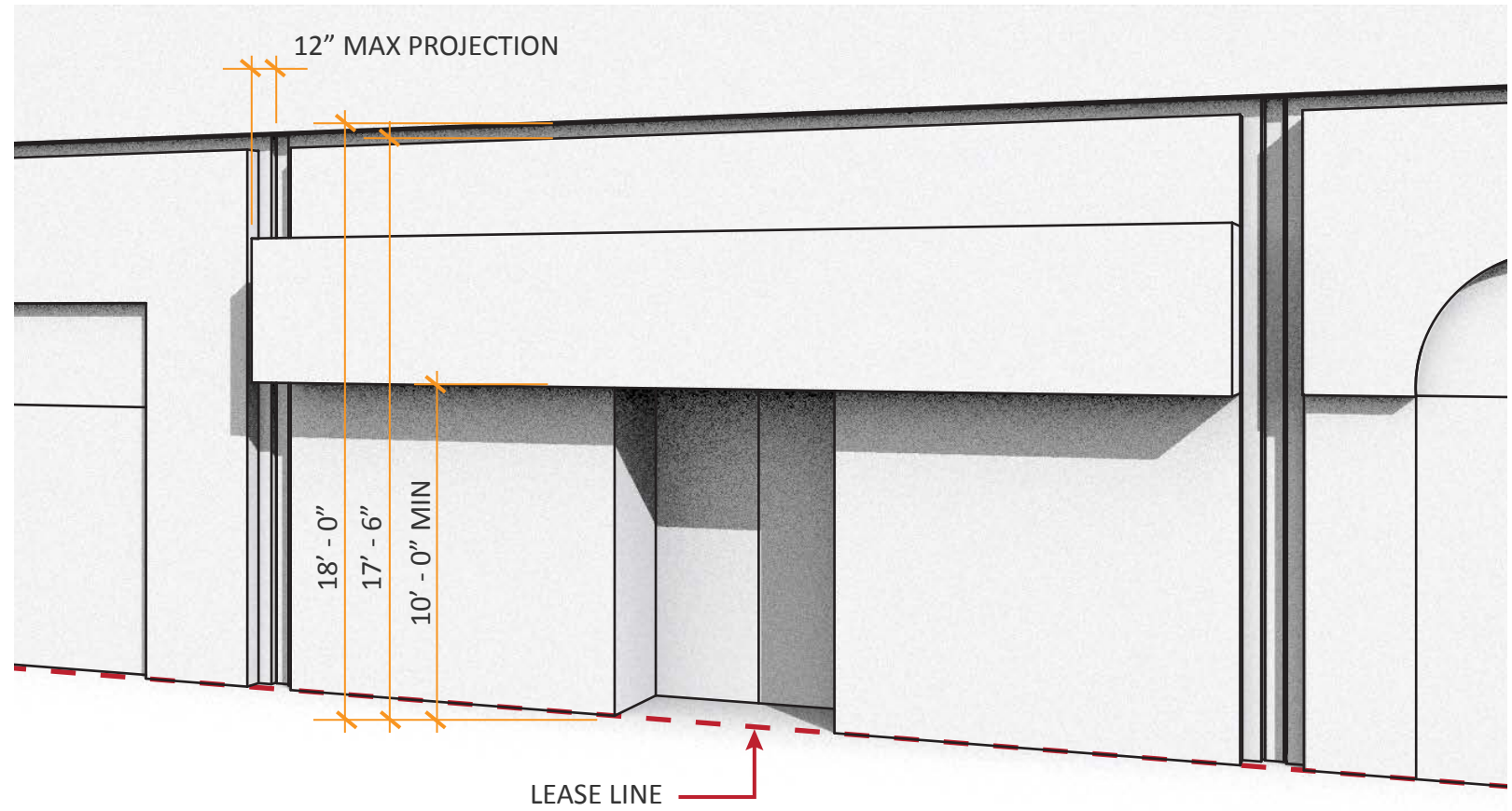
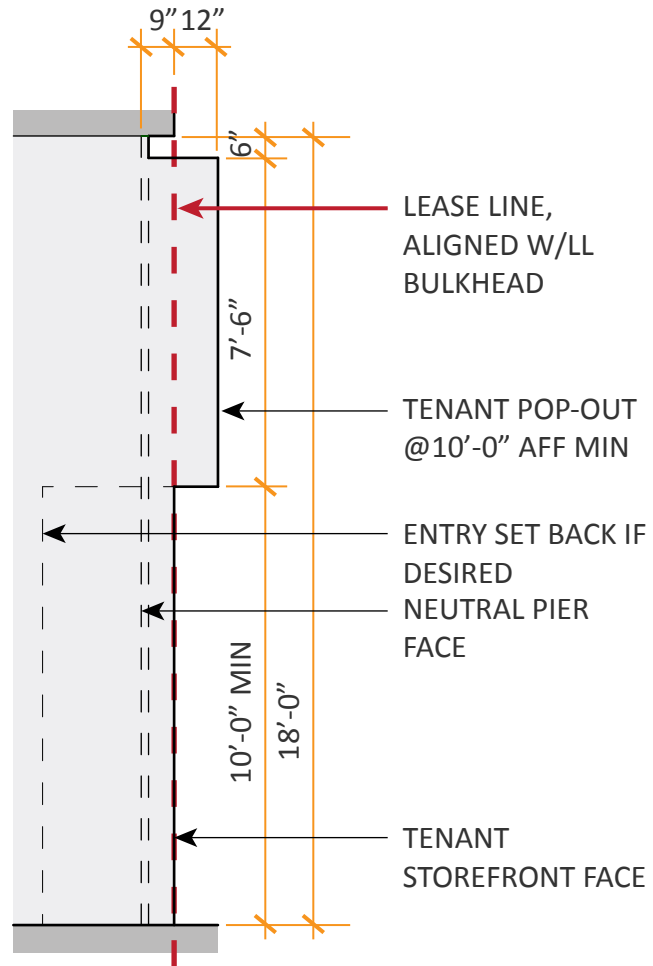

DETAILS, PHOTOS & GRAPHICS

ZONE 2 CRITERIA



ZONE 2 REQUIREMENTS

- Zone 2 may need to extend any neutral pier adjacent to their space out into the common area per details provided.
- Required storefront height at north side 17'-6" with a 6" wide reveal above, finished to complement the Tenant storefront.
- Tenant lease line is located 1'-2" from face of Landlord neutral pier.
- 2'-0" max storefront projection above 10'-0" AFF is strongly suggested. A projecting element is required between 10'-0" to 17'-6" AFF. The design intend is not to have the entire area project out but to create a zone specifying where some sort of projection would be allowed. Consult with Tenant Coordinator regarding this requirement. The design objective is to create movement and interest by popping-out/popping-in.
- Entry width shall be no greater than 8'-0". Closure shall be by swing type doors recessed at least 3'-0" in depth from face of storefront.
- Tenant to install Tenant's durable floor covering to lease line. Tenant is responsible to bring Tenant's floor covering to Mall's common area tile at lease line, and make any adjustments in grade change to meet ADA requirements. Tenant to install Tenant's floor covering in Tenant entry door vestibule.
- For any existing conditions at neutral piers that do not comply with the details shown for the applicable Tenant zone, it is the Tenant's responsibility to bring the adjacent neutral pier(s) into compliance per the Tenant Criteria Manual.
- Neutral pier paint will be provided by the Mall Property Team for consistency with existing conditions.
- Height to deck in some areas of this zone is 40'-0". Field verify.

ZONE 2 DETAILS

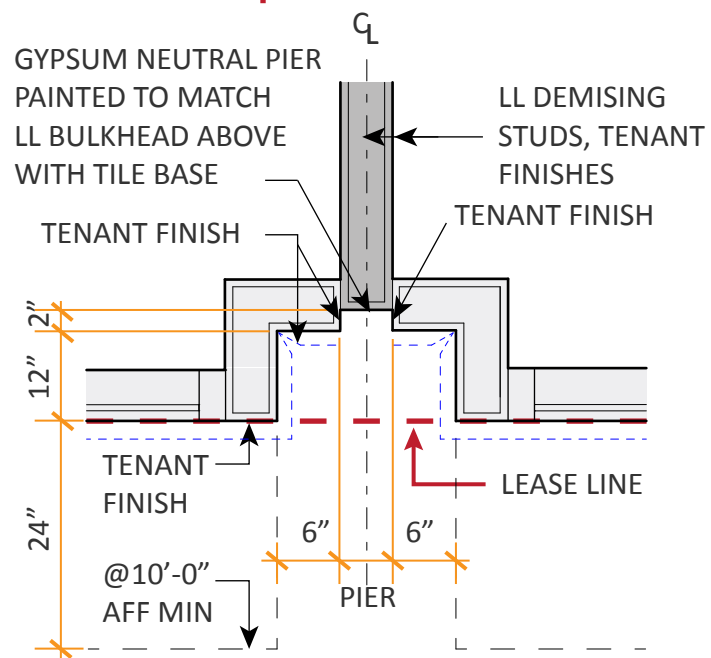
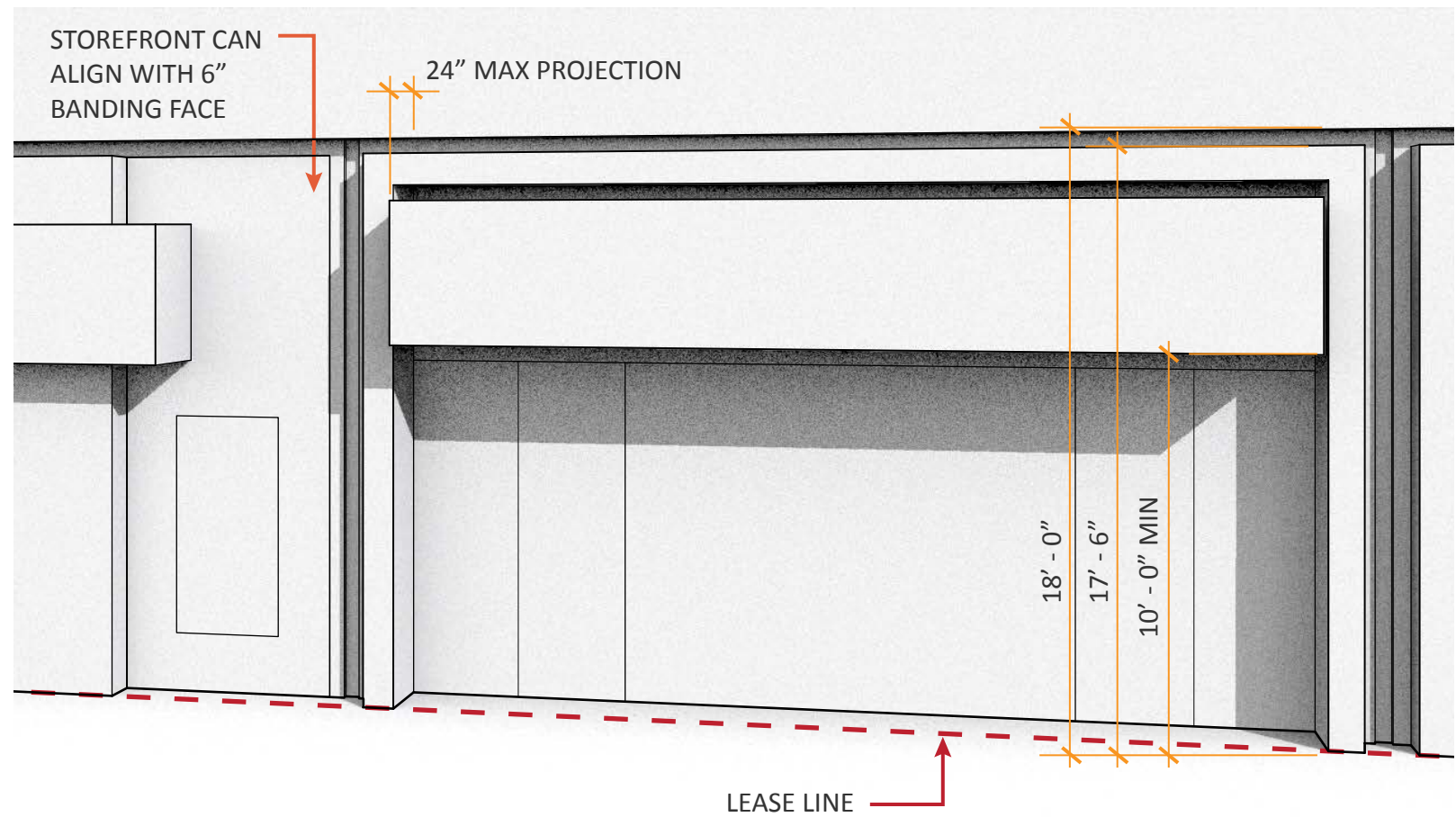
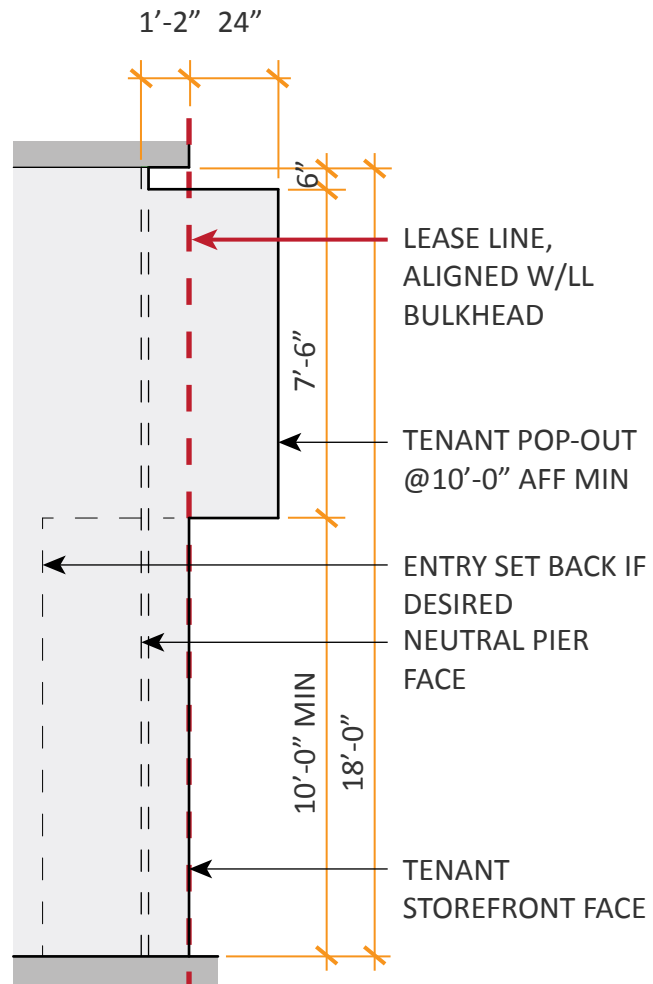

DETAILS, PHOTOS & GRAPHICS

ZONE 3 CRITERIA



ZONE 3 REQUIREMENTS

- Required storefront height at south side is 13'-6" AFF with a 6" wide reveal above, finished to complement the Tenant storefront.
- Tenant lease line is located 9"-12" from the face of the Landlord neutral pier. Tenant finishes must extend to this line.
- The face of the storefront needs to be aligned with the Landlord bulkhead above.
- Entry width shall be no greater than 8 ft. Closure shall be by swing type doors recessed at least 3'-0" in depth from face of storefront.
- Tenant to install Tenant's durable floor covering to lease line. Tenant is responsible to bring Tenant's floor covering to Mall's common area tile at lease line, and make any adjustments in grade change to meet ADA requirements. Tenant to install Tenant's floor covering in Tenant's entry door vestibule.
- ****Special Condition:** This location does not conform to the Zone 3 standard. There is no 6" reveal above, so storefronts are required to be raised to 14'-4". Please contact your Tenant Coordinator for additional standards or variances for these locations.
- For any existing conditions at neutral piers that do not comply with the details shown for the applicable Tenant zone, it is the Tenant's responsibility to bring the adjacent neutral
- Neutral pier paint will be provided by the Mall Property Team for consistency with existing conditions.

ZONE 3 DETAILS

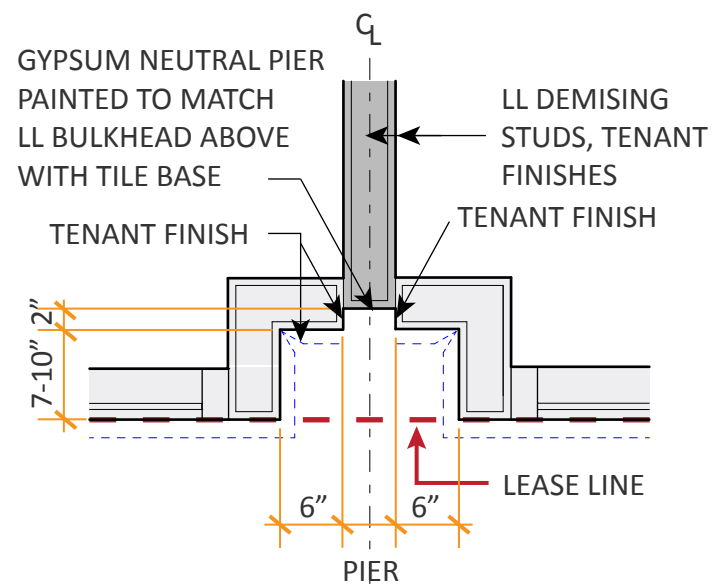
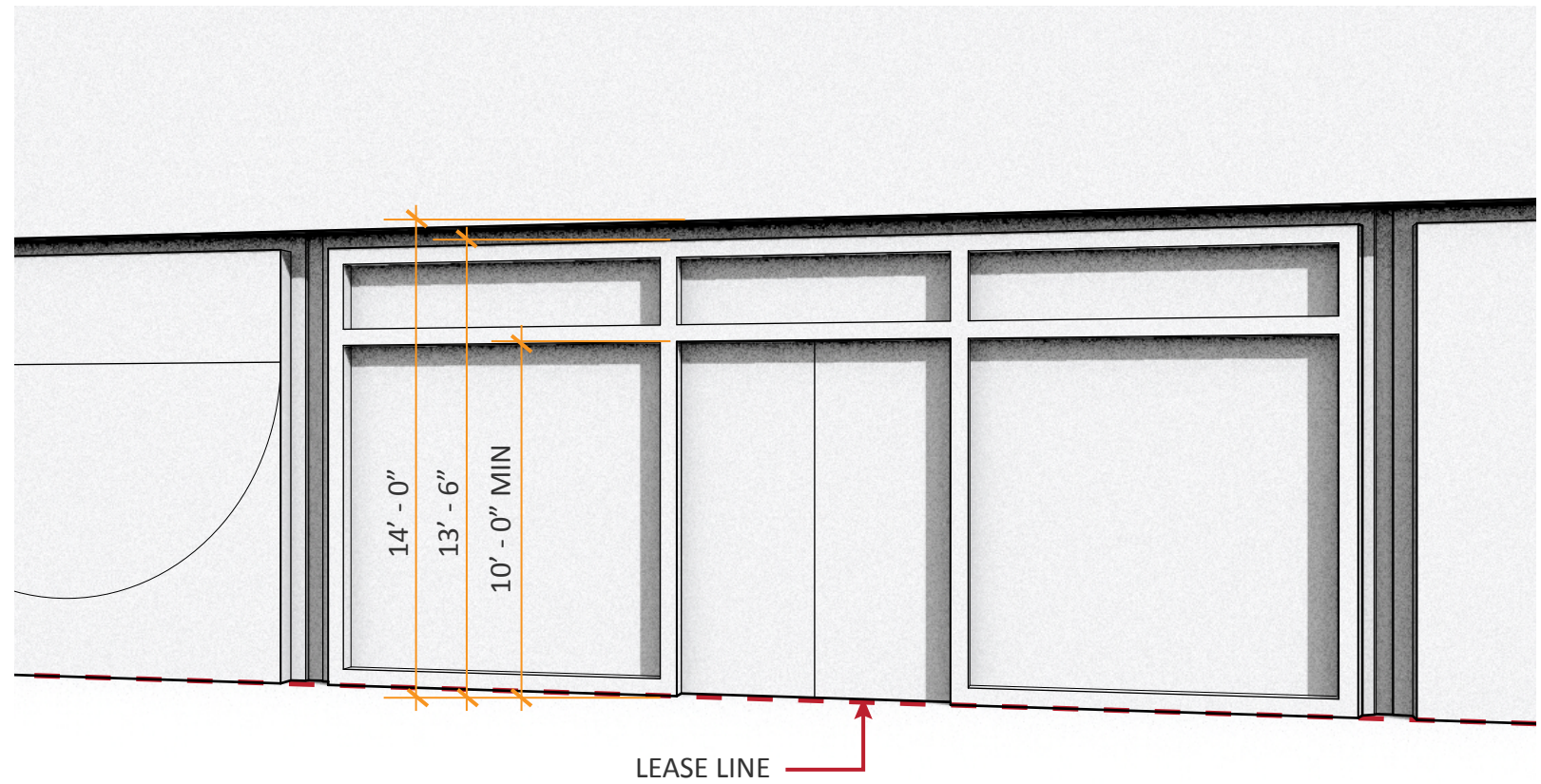
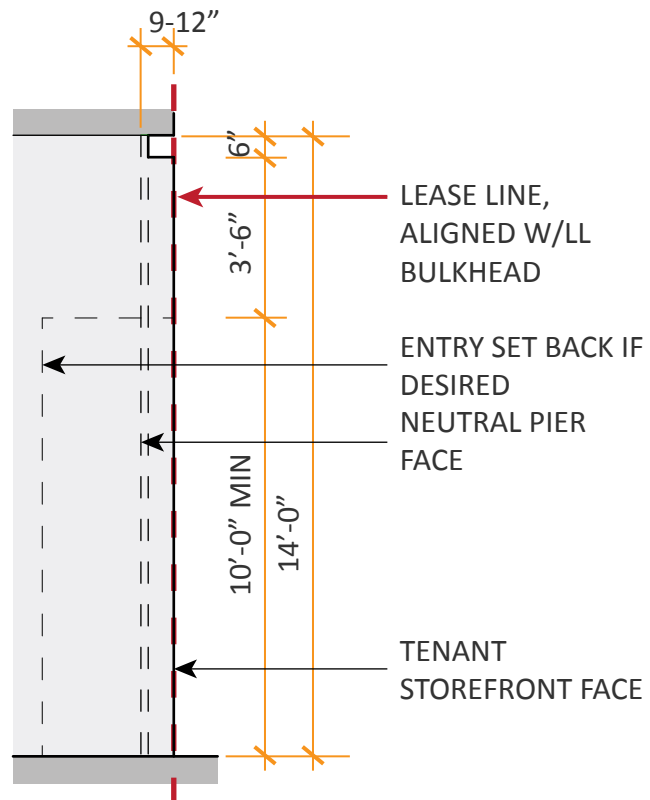

DETAILS, PHOTOS & GRAPHICS

ZONE 4 CRITERIA

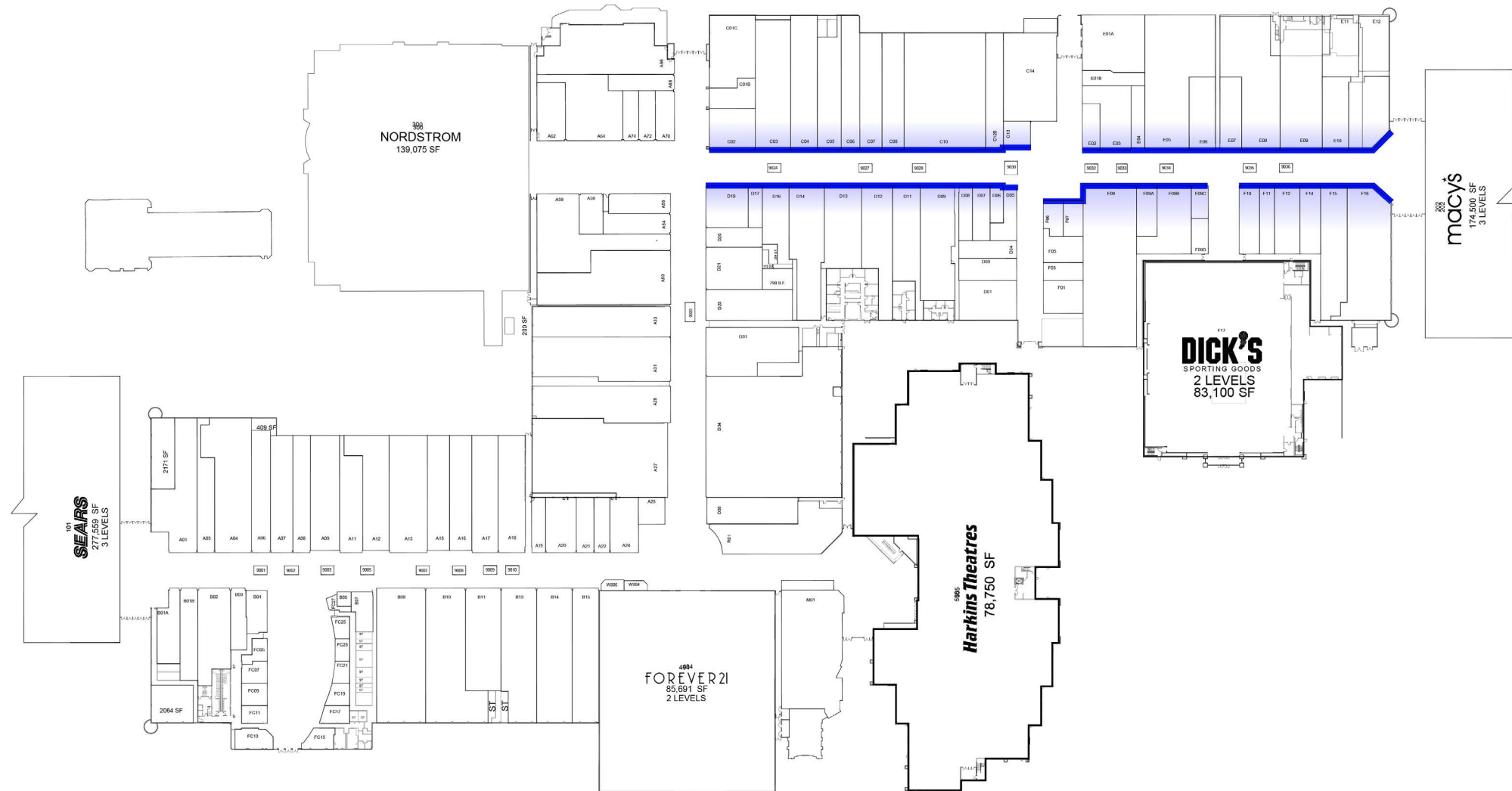

ZONE 4 REQUIREMENTS

- Required storefront height 14'-0" (VIF with Tenant Coordinator).
- Tenant lease line is located 20"- 22" from face of Landlord neutral pier.
- 1'-0" storefront projection above 9'-0" AFF is strongly suggested. A projecting element is required between 9'-0" to 14'-0" AFF. The design intend is not to have the entire area project out but to create a zone specifying where some sort of projection would be allowed. Consult with Tenant Coordinator regarding this requirement. The design objective is to create movement and interest by popping-out/popping-in. The storefront cannot be on one plane.
- Storefronts must pop-out beyond face of bulkhead and pop-up into the mall. Storefronts to have 6" x 12'-0" wing on each side of neutral pier. See neutral pier detail
- Tenants may project selected elements of the storefront (located 9 ft. or more a.f.t.) up to 3ft. into the mall, measured from face of mall fascia. Overhead projections shall be a layering of architectural elements and never be overly massive in nature.
- Tenant to install Tenant's durable floor covering to lease line. Tenant is responsible to bring Tenant's Floor covering to mall's common area tile at lease line, and make any adjustments in grade change to meet ADA requirements. Tenant to install Tenant's floor covering in Tenant entry door vestibule.
- For any existing conditions at neutral piers that do not comply with the details shown for the applicable Tenant zone, it is the Tenant's responsibility to bring the adjacent neutral pier(s) into compliance per the Tenant Criteria Manual.
- Neutral pier paint will be provided by the Mall Property Team for consistency with existing conditions.

ZONE 4 DETAILS

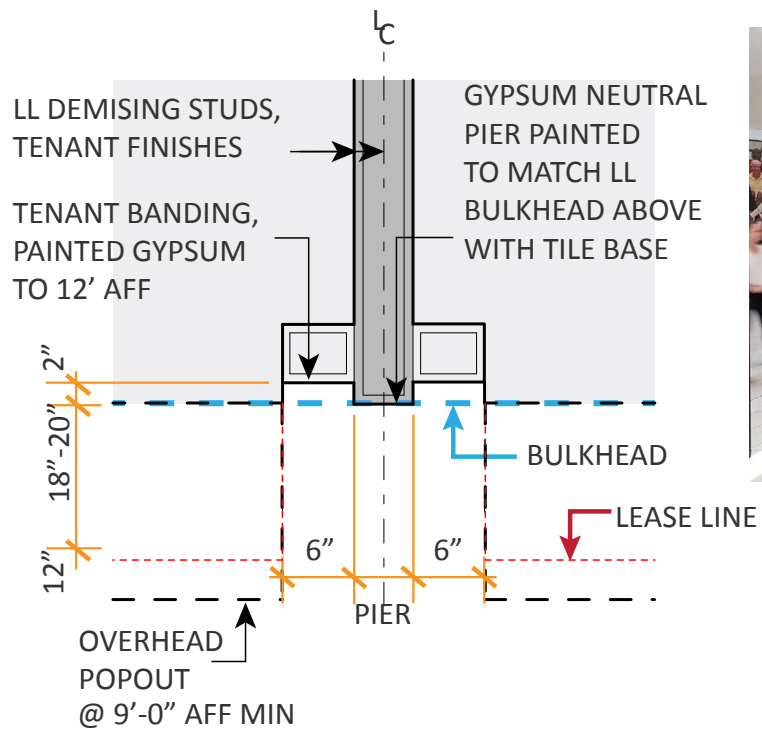
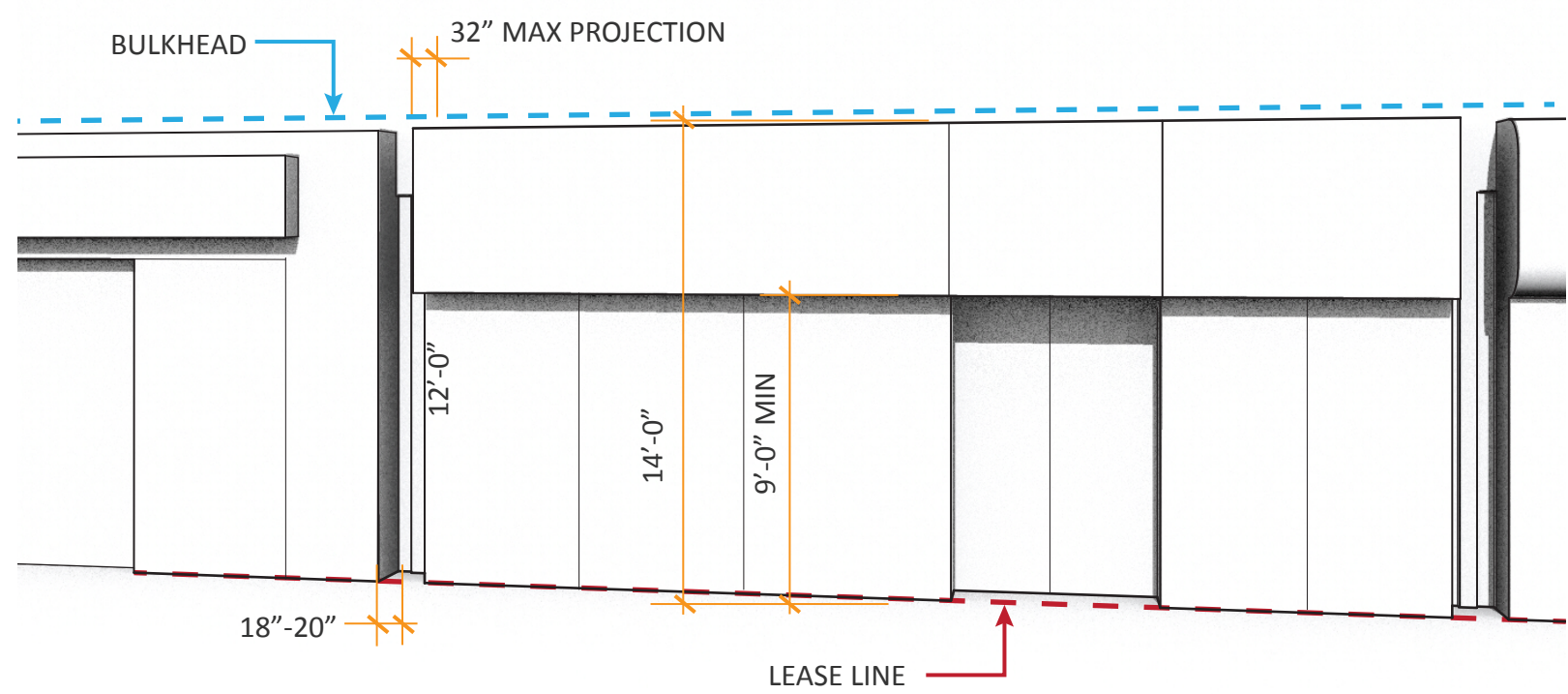
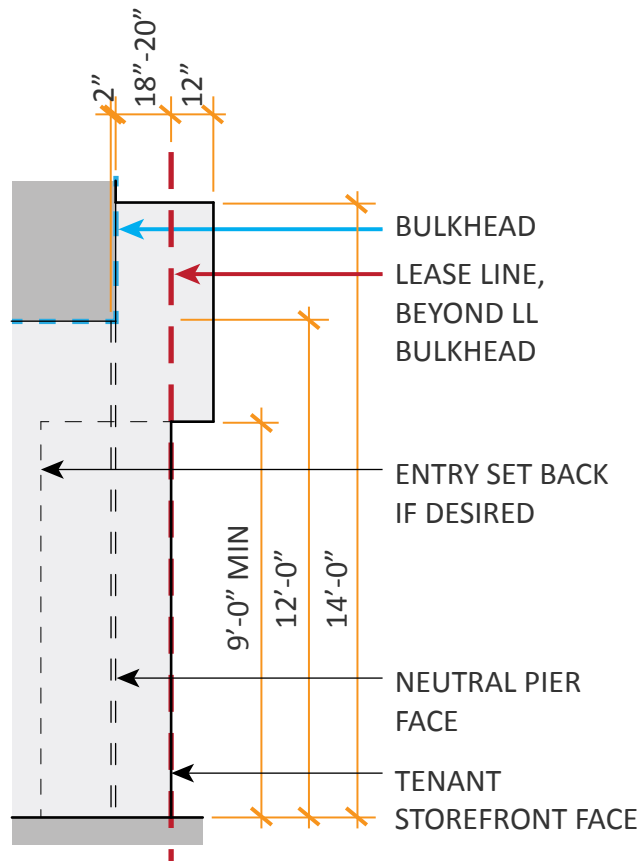

DETAILS, PHOTOS & GRAPHICS

ZONE 5 CRITERIA



ZONE 5 REQUIREMENTS

- Required storefront height 17'-0". In areas with dropped soffit contact the mall Tenant Coordinator for height requirement.
- Tenant lease line is located 24-26" from face of Landlord neutral pier.
- 1'-0" storefront projection above 10'-0" AFF is strongly suggested from lease line. A projecting element is required between 10'-0" to 17'-0" AFF. The design objective is to create movement and interest by popping-out/popping-up. Storefront cannot be on one plane. Max 3' projection will be allowed from Landlord bulkhead.
- Storefronts must both pop out beyond face of bulkhead and pop up into the mall. Storefront to have 6" x 12'-0" wing on each side of neutral pier. See neutral pier detail.
- Storefronts located under high mall ceilings (20'-0" AFF) are in special pop up zones and are required to incorporate special design features which extend selected elements of the storefront above. Such elements may project from, apply to, penetrate into, or penetrate through the Landlord fascia up to 17' above the mall floor.
- Tenant to install Tenant's durable floor covering to lease line. Tenant is responsible to bring Tenant's floor covering to Mall's common area tile at lease line, and make any adjustments in grade change to meet ADA requirements. Tenant to install Tenant's floor covering in Tenant entry door vestibule.
- For any existing conditions at neutral piers that do not comply with the details shown for the applicable Tenant zone, it is the Tenant's responsibility to bring the adjacent neutral pier(s) into compliance per the Tenant Criteria Manual.
- Neutral pier paint will be provided by the Mall Property Team for consistency with existing conditions.

ZONE 5 DETAILS

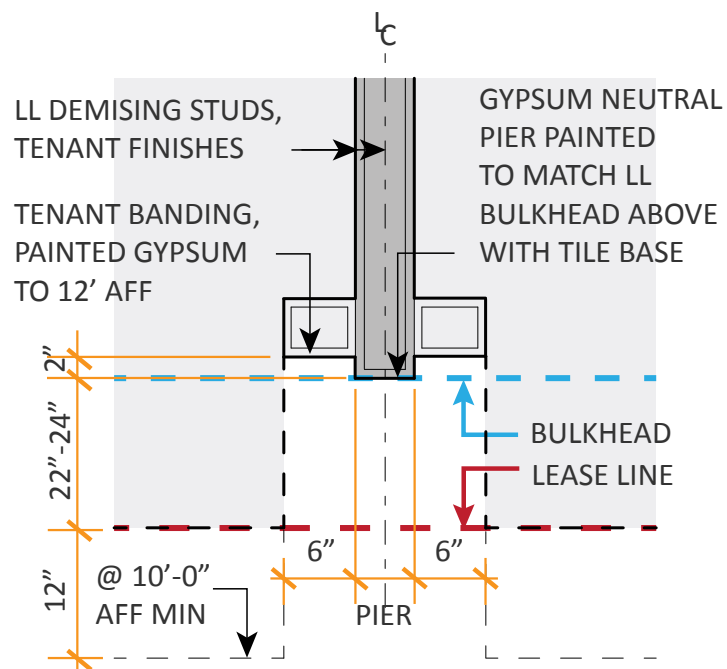
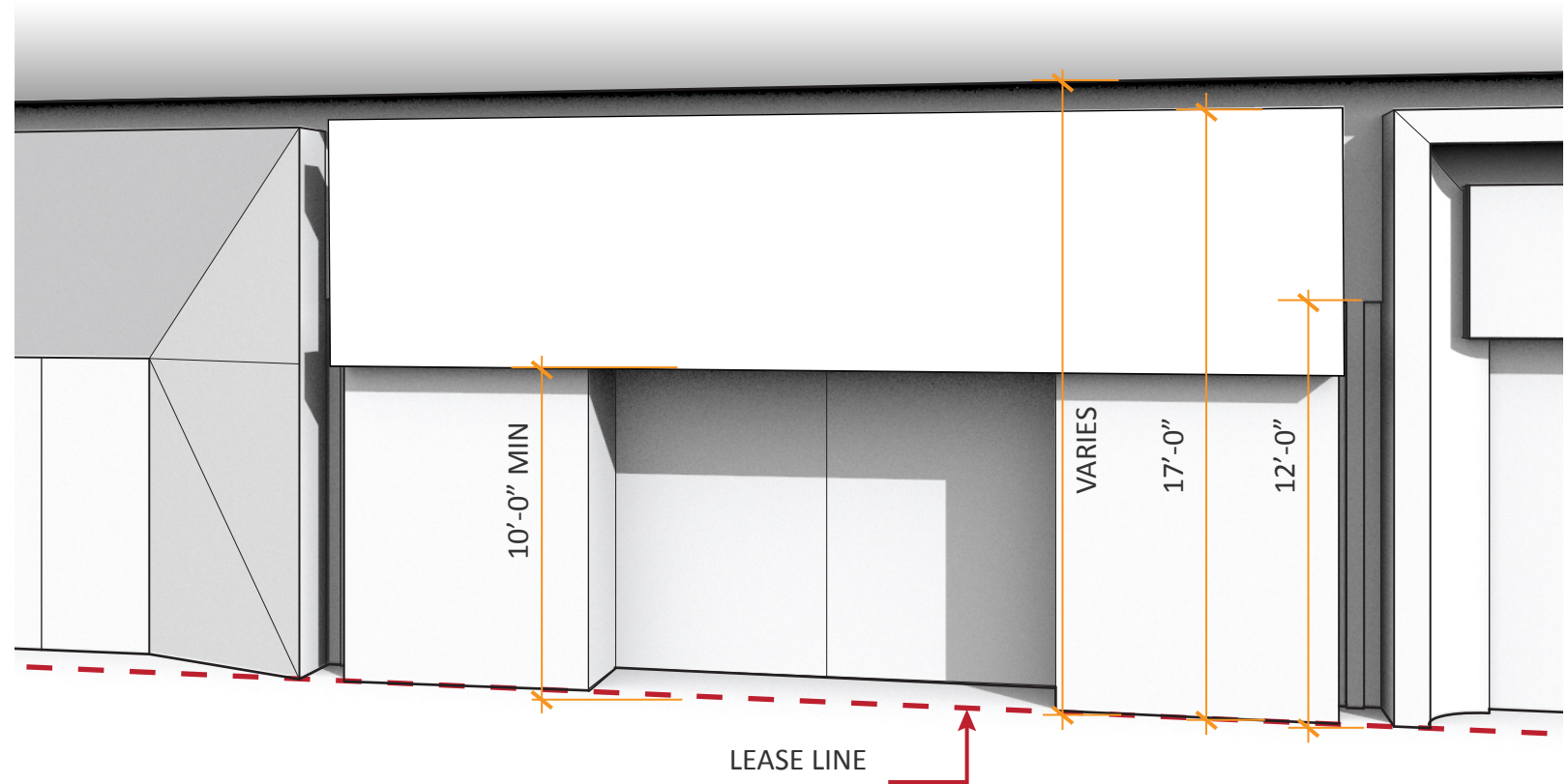
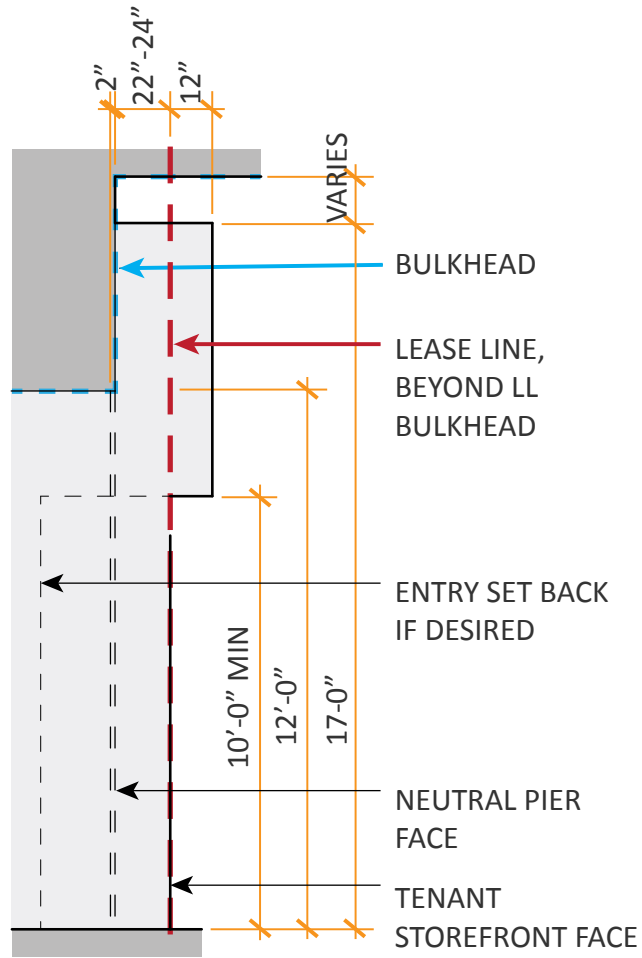

DETAILS, PHOTOS & GRAPHICS

ZONE 6 CRITERIA



ZONE 6 REQUIREMENTS

- Required storefront height is 12'-0".
- Tenant lease line is flush with the face of the Landlord neutral pier.
- The face of the Tenant storefront needs to be aligned with the Landlord bulkhead above.
- Tenant to install Tenant's durable floor covering to lease line. Tenant is responsible to bring Tenant's floor covering to Mall's common area tile at lease line, and make any adjustments to grade change to meet ADA requirements. Tenant to install Tenant's floor covering in Tenant entry door vestibule.
- For any existing conditions at neutral piers that do not comply with the details shown for the applicable Tenant zone, it is the Tenant's responsibility to bring the adjacent neutral pier(s) into compliance per the Tenant Criteria Manual.
- Neutral pier paint will be provided by the Mall Property Team for consistency with existing conditions.

ZONE 6 DETAILS

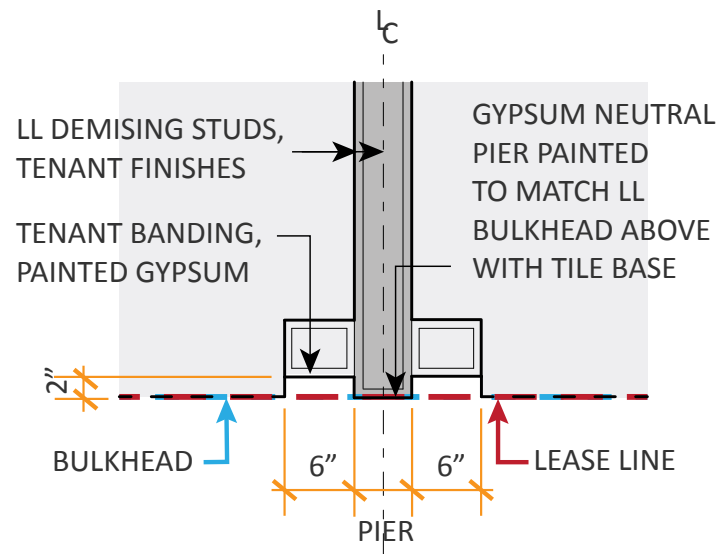
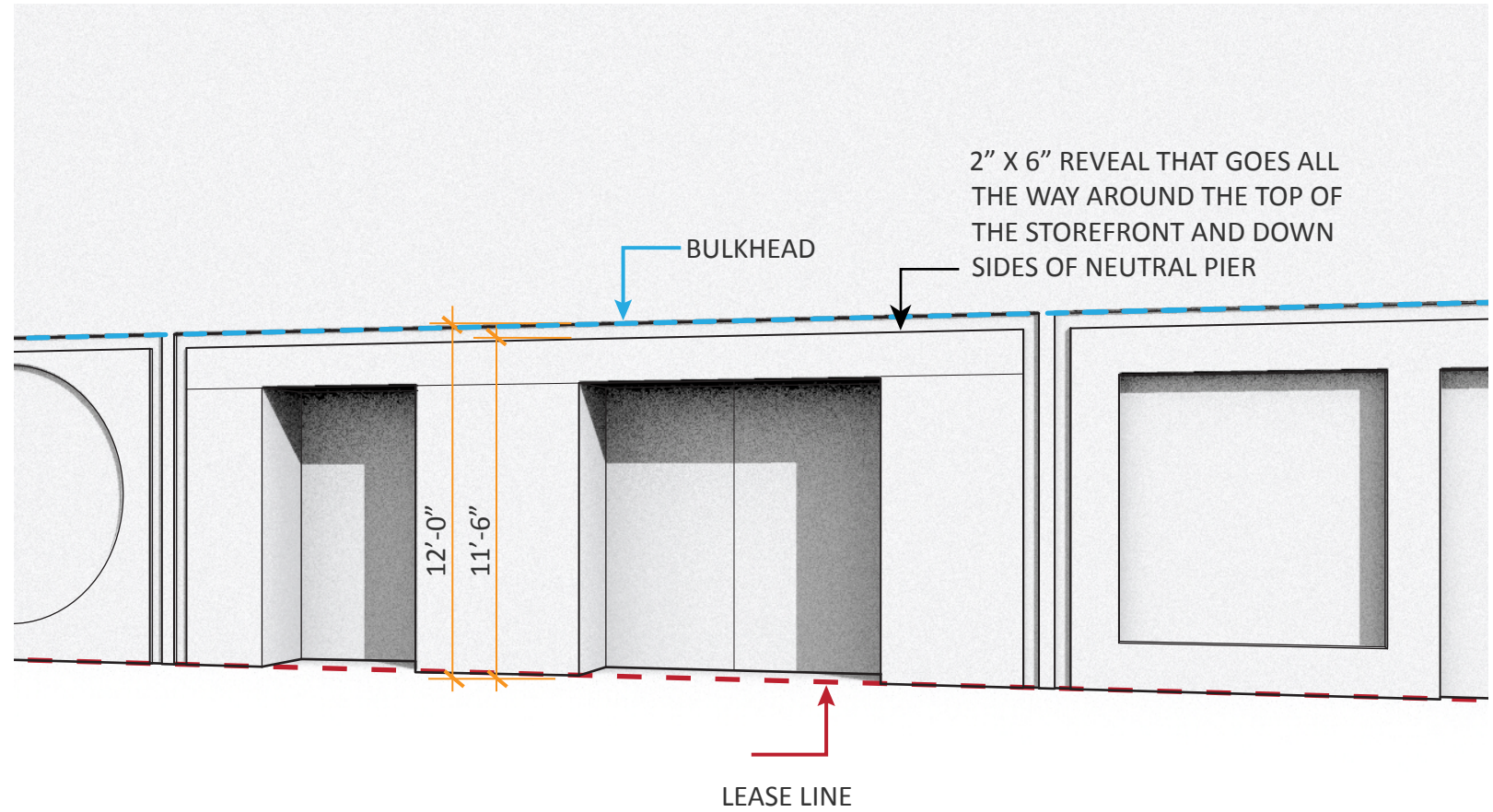
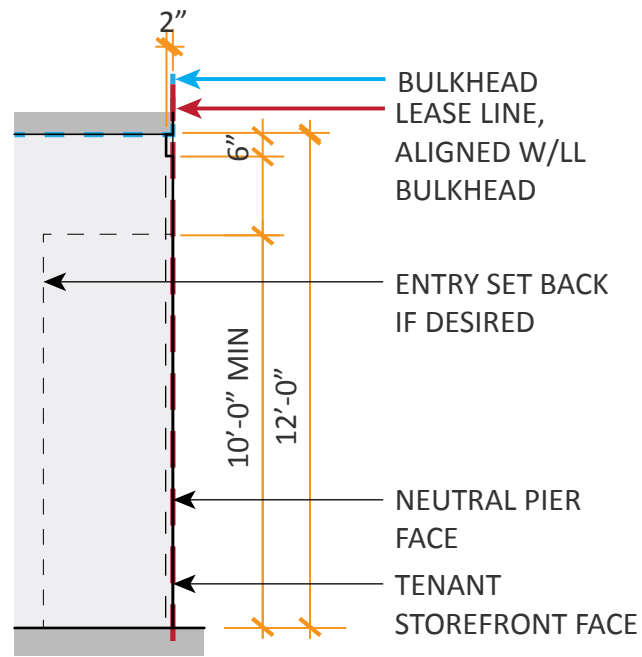

DETAILS, PHOTOS & GRAPHICS

DESIGN INSPIRATION CONTENT OVERVIEW

4.1

VISUAL CONCEPTS

GUIDE TO DIFFERENT AESTHETIC CONCEPT ENCOURAGING VIBRANT STORE DESIGNS.

4.2

KEY DESIGN ELEMENTS

OVERVIEW OF THE CORE DESIGN ELEMENTS TO EMBRACE WHEN CREATING AN ENLIVENING RETAIL EXPERIENCE.

The vibrant character of great shopping destinations is comprised of exceptional storefronts with texture, color, lighting, graphics and merchandising enlivening the pedestrian experience.

Tenants are encouraged to express their individuality and their brand identity through excellent design by forward thinking design teams.



VISUAL CONCEPTS > OVERVIEW

- ARTISAN
- URBAN
- WHIMSICAL
- INVITING
- ARTSY
- THEATRICAL

This section highlights six design concepts encouraged by Macerich for Tenant's looking for additional store design inspiration. Our design team welcomes Tenants to engage in these concepts and invites open collaboration in an effort to create store designs that enhance the retail experience.

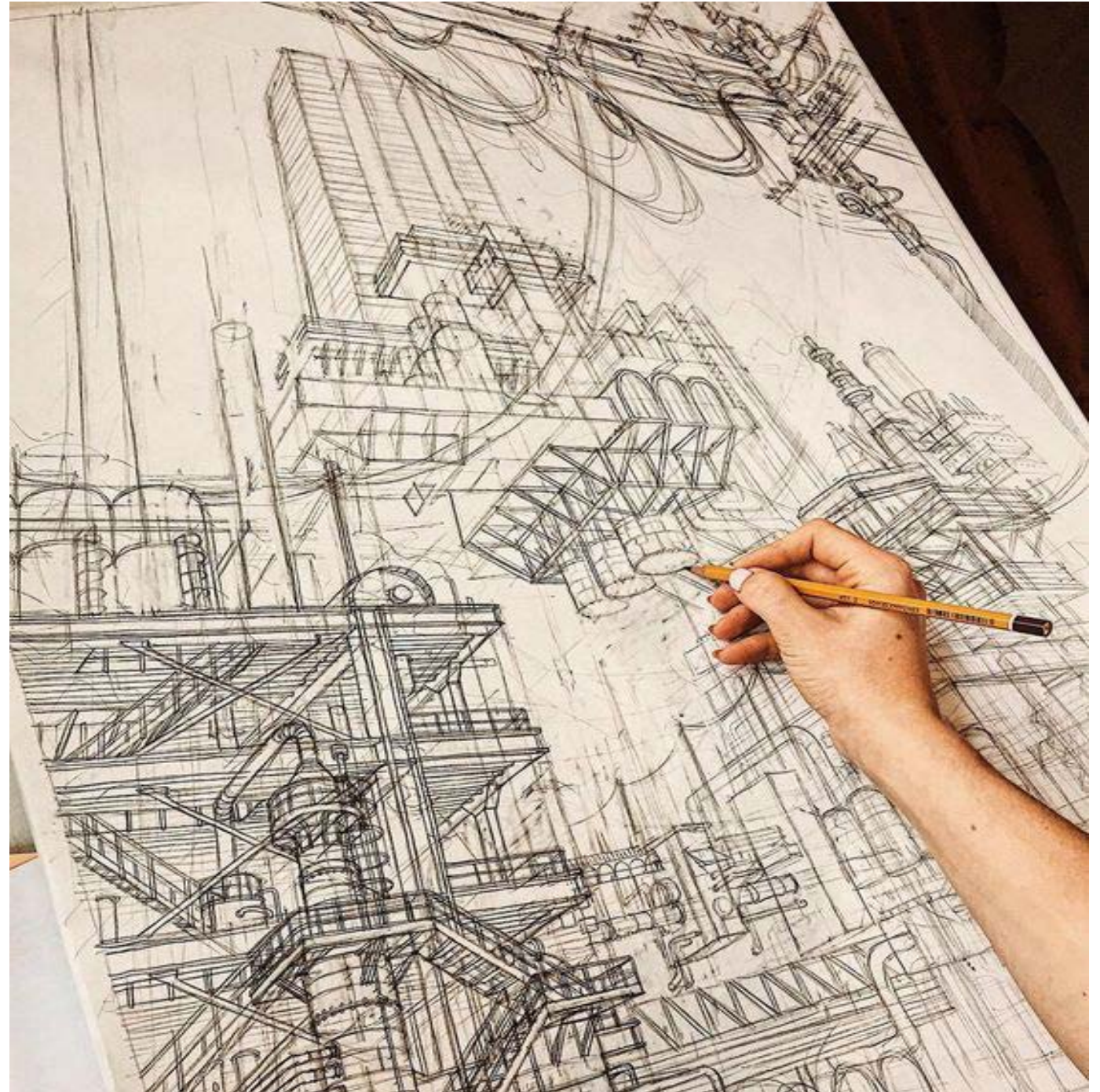

> ARTISAN

ARTISAN

NATURAL, SOPHISTICATED, UNIQUE



> URBAN

URBAN

EDGY, FUNKY, STREET SAVVY STYLE, INDUSTRIAL



> WHIMSICAL

WHIMSICAL

UNEXPECTED, PLAYFUL, COLORFUL



> INVITING

INVITING
WARM, CALM, OPEN, SOFT



> ARTSY

ARTSY

QUIRKY, AVANT GARDE, SURPRISING



> THEATRICAL

T H E A T R I C A L
DRAMATIC, HIGH CONTRAST, MOVEMENT

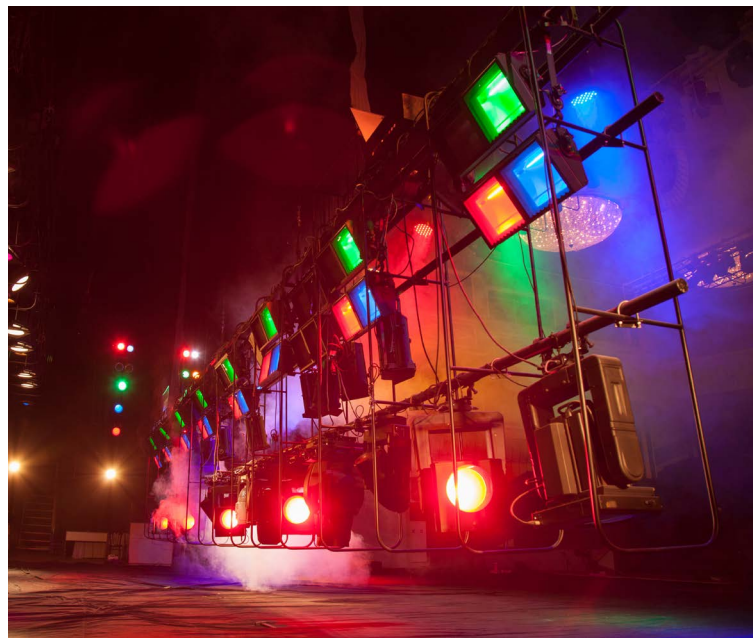

KEY DESIGN ELEMENTS > BRANDING / VISUAL MERCHANDISING

Macerich embraces four key design elements to engage customers and encourage store traffic and sales. Strong use of textures, colors, lighting, graphics, and merchandising in these elements help draw customers and invliven the pedestrian experience.

BRANDING

A brand is a name, term, design, symbol, color or some other feature that identifies a seller's product or services as distinct from those of other seller's.

Your branding can be communicated with signage, graphics, materials, shapes, colors, textures, patterns and the overall look and feel of your kiosk, to tell a story and create a lasting experience.



VISUAL MERCHANDISING

Strong visual presentation and merchandising are essential and integral components of retail design.

- Attempt to create triangular composition within style groups or color groups. (display in groups of three or five).
- Start with a center feature, (best sellers and hot items), and merchandise out symmetrically or asymmetrically in a balanced manner.



> LAYERING / TECH AND MEDIA

LAYERING

How can you make a wall / elevation into a canvas for communication to the customer as they walk towards or by your store?

1. Incorporating patterns and textures.
2. Overlaying materials to create dimensionality.
3. Molding shapes to create softness.
4. Overlapping to create shadows and depth.



TECHNOLOGY AND MEDIA

Technology can enhance your on line operation by transforming your retail space into a multifunctional one, that lends itself to being an in store pick up location, payment booth or advertising billboard.

Integrating technology into your store design can:

1. Become an extension of you.
2. Supplement your salesforce with interactive screens for ordering, design yourself functions and more.
3. Keep your business connected with your customer.
4. Help you tell a story.
5. Help make menu boards easier to update and better communicate your offerings to your customer via LCD screen loops.

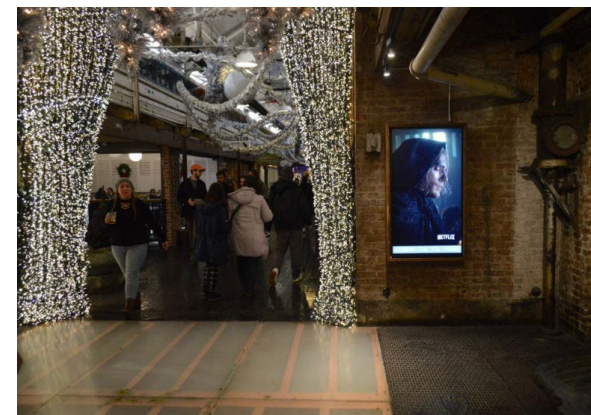

PROPERTY INFO CONTENT OVERVIEW

5.1

ADDRESS & HOURS

LOCATION AND SCHEDULE INFO.

5.2

SITE PLAN

OVERVIEW MAP OF CENTER.

5.3

CONTACTS

MALL CONTACTS, REQUIRED CONTRACTORS, LOCAL MUNICIPALITIES, AND UTILITY CONTACT INFO.

5.4

CODES AND PERMITTING

OVERVIEW OF BUILDING CODE, CLASSIFICATIONS, AND LOCAL PERMITTING.

5.5

OPERATIONS AND UTILITIES

OVERVIEW OF CENTER OPERATIONS AND TYPICALLY AVAILABLE UTILITIES.

5.6

CONSTRUCTION

OVERVIEW OF CONSTRUCTION PROCEDURES.

SECTIONS OF INTEREST

The following sections provide additional details and requirements related to this Criteria:

ADDENDUM

Provides additional construction requirements to contractors.

The Property Info Criteria provides an overview of the Center's building classification, contacts, local permitting, and typically provided utilities.

It is important to note that the Contacts section includes the Center's required contractors. These contractors **must** be used during the design and buildout of your store.



ADDRESS & HOURS

ADDRESS AND HOURS

Los Cerritos Center is located at the intersection of South Street and Gridley Road, bordered to the west by the 605 Freeway, in the City of Cerritos. The Center is open 7 days a week. Open hours for individual restaurants and entertainment venues may vary.

Center Address

239 Los Cerritos Center
Cerritos, CA 90703

Center Hours

Contact the mall office at: (562) 860-0341

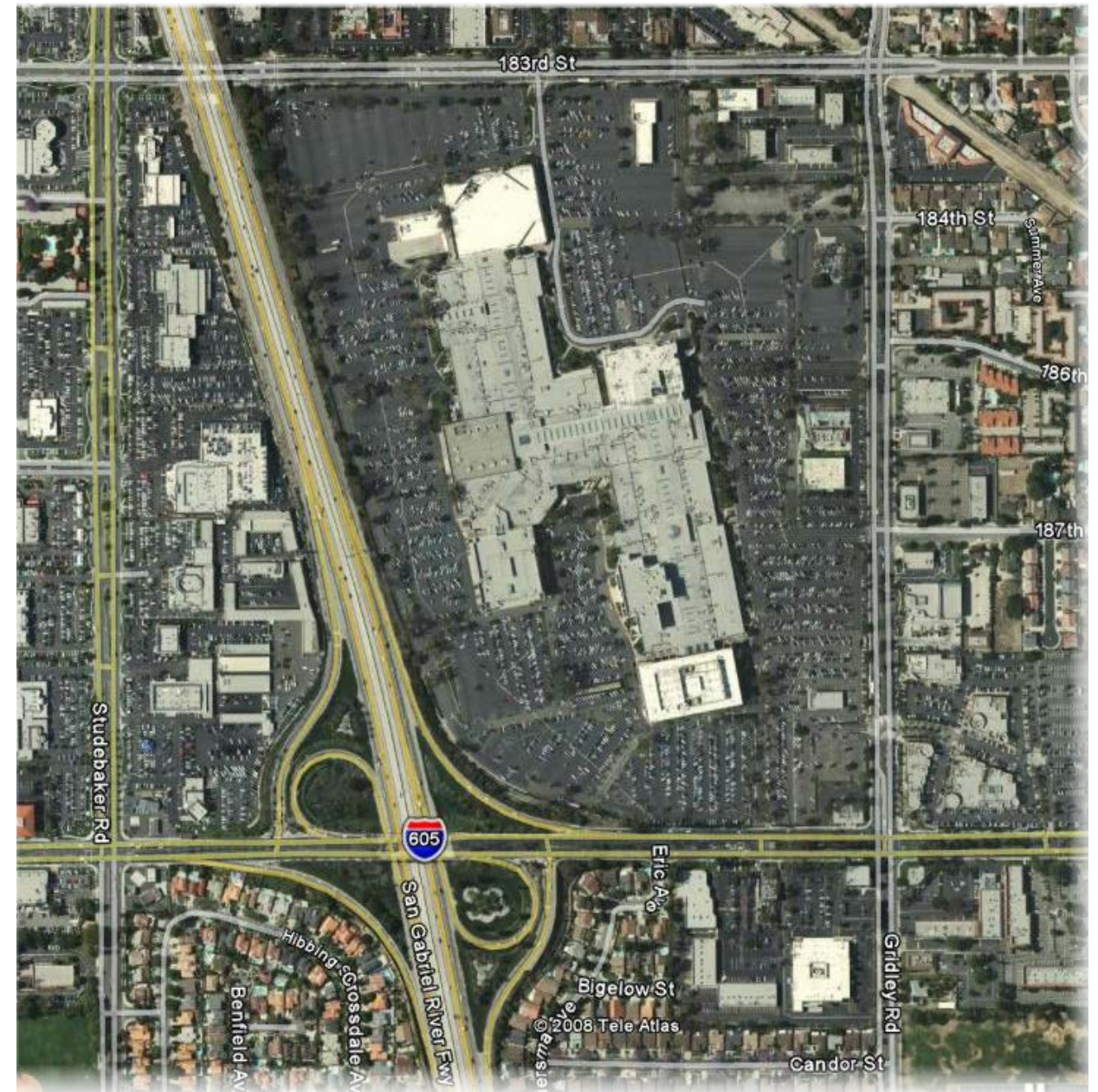

SITE PLAN

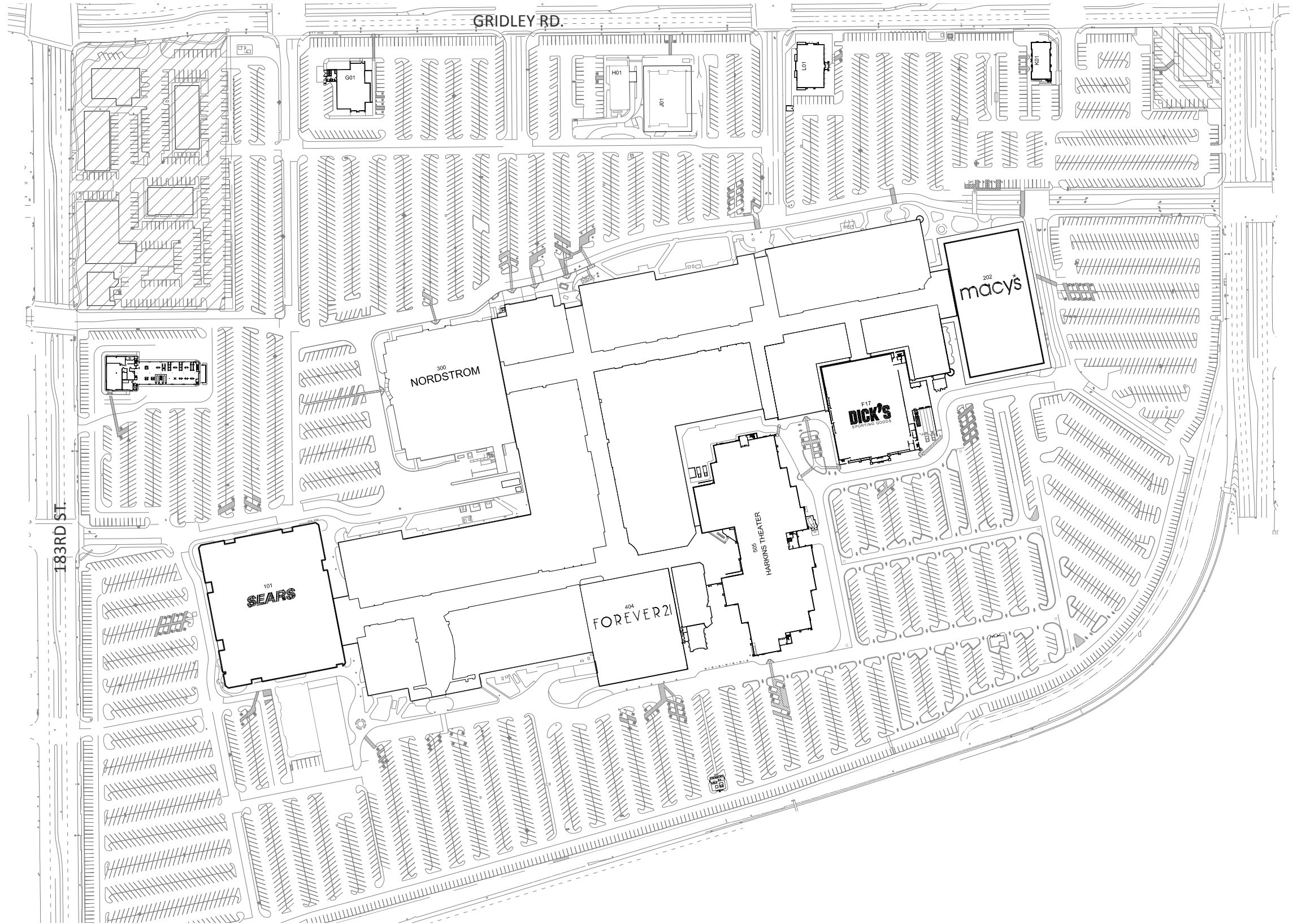

CONTACTS > PROPERTY TEAM / REQUIRED CONTRACTORS

PROPERTY TEAM

The following points of contacts are available to discuss site details and procedures. The primary point of contact for inquiries is the Tenant Coordinator.

PROPERTY MANAGER

Nicole Fulton

Phone: (562) 860-0341

Nicole.Fulton@macerich.com

OPERATIONS MANAGER

Nick Snyder

Phone: (562) 860-0341

nick.snyder@macerich.com

TENANT COORDINATION

Gena Esposito

Phone: (424) 229-3404

gena.esposito@macerich.com

LEASING

Hayley Rable

Phone: (424) 229-3504

hayley.rable@macerich.com

LANDLORD/OWNER

The MACERICH Company

401 Wilshire Blvd., Suite 700

Santa Monica, CA 90401

REQUIRED CONTRACTORS

The following points of contacts are the required contractors that must perform the construction for their related systems. These contractors are required since they have intimate knowledge of the property building systems and can properly interface Tenant systems with the base building infrastructure.

SPRINKLER CONTRACTORS

Ortiz Fire Protection

Phone: (714) 767-9240

ELECTRICAL SUBMETERS

Amps/DMS

Phone: (323) 933-9443

DATA PROVIDER

Granite Grid

****It is highly recommended to coordinate service**

install a minimum of 4 weeks in advance

Johanna Paula Jumawan

Strategic Infrastructure Support

O: (888) 860-1365

M: (857) 403-6340

Jpjumawan@granitenet.com

FIRE ALARM CONTRACTOR

JMG Security

Phone: (714) 545-8882

ROOFING CONTRACTOR

Emmons Roof Service

Phone: (909) 460-5900

Barricade

Boston Barricade

SO-CA Local Team

Cody Howell (GM)

760-599-9708

chowell@bostonrs.com

Autumn Sandoval (PM)

760-599-9700

asandoval@bostonrs.com

CONTACTS > UTILITIES / LOCAL AGENCIES

UTILITIES

The following points of contacts are the utility companies necessary to interface with to set up utility accounts:

ELECTRICAL

Southern California Edison Company
2800 East Willow
Long Beach, CA 90806
Phone: (800) 990-7788

DATA

Data is required to be set up through Granite Grid. Other service providers do not have a Right of Entry agreement and are not permitted.

Granite Grid

****It is highly recommended to coordinate service install a minimum of 4 weeks in advance**

Johanna Paula Jumawan

Strategic Infrastructure Support

O: (888) 860-1365

M: (857) 403-6340

jpjumawan@granitenet.com

GAS

Gas utility is only available for food use. Gas is not available for heating.

Southern California Gas Company
555 West 5th Street
Los Angeles, CA 90013
Phone: (800) 427-2000

TRASH

Athens

Phone: (888) 336-6100

<https://athensservices.com/commercial-services>

WATER

The City of Cerritos provides water meters. Most retail Tenants will not have their own meter, restaurants only

Water Billing for the City of Cerritos

Phone: (562) 916-1235

LOCAL AGENCIES

The following points of contacts are the local agencies responsible for plan reviews and inspections:

BUILDING AND SAFETY

City of Cerritos

Department of Building and Safety

18121 Bloomfield Avenue

Bellflower, CA 90701

Phone: (562) 860-0311

HEALTH DEPARTMENT

L.A. County Health Services

12440 E. Imperial Hwy. Rm. 519

Norwalk, CA 90651

Phone: (562) 345-6800

FIRE DEPARTMENT

County of Los Angeles Fire Department

19030 Pioneer Blvd.

Cerritos, CA 90903

Phone: (562) 860-8014

BUSINESS LICENSING

The City of Cerritos

Phone: (562) 916-1236

THE CITY OF CERRITOS COMMUNITY DEVELOPMENT

Phone: (562) 916-1201

<http://www.cerritos.us/businesses.php>

CODES AND PERMITTING

BUILDING CODE OVERVIEW

Los Cerritos Center offers spaces for retail, restaurants, and entertainment. Below are the pertinent property details related to local building codes. It is the sole responsibility of the Tenant's Architect, Engineers, Consultants, and Contractors to comply with all applicable federal, state, and local codes and ordinances for their occupancy type.

Building Type

Single level regional shopping center

Approved Occupancy Types

Mixed-Use Mercantile (M), Covered Mall

Construction Classification

Type II B

Applicable Codes

Currently adopted edition of the IBC as amended and adopted by the City of Cerritos.

It is the sole responsibility of the Tenant's Architect, Engineers, Consultants, and Contractors to comply with all applicable federal, state, and local codes and ordinances for their occupancy type.

PERMITTING

Tenant construction, signage, and food service all require permitting from the City of Cerritos.

I. BUILDING PERMIT

For all construction, prior to work commencement, building and other required permits shall be obtained by the Tenant.

Building Permits are filed with the City of Cerritos. All City fees must be paid at the time of submittal, and those costs are determined at the time of submittal.

The average permit issuance timeframe to first set of City comments is about 2 months, with a longer review period for restaurants.

Please contact the City of Cerritos for more information:

City of Cerritos Building and Safety Division

Phone: (562) 916-1209

Phone: (562) 916-1201 Permit Application Questions

http://www.cerritos.us/BUSINESSES/planning_and_building_permits.php

Any submittals made to the City of Cerritos must include a wet stamp by the mall. The City will not accept any submittals without it.

II. SIGN PERMIT

Sign Permits are required by the City of Cerritos for both mall interior and exterior Tenant signage. Permitting time varies, especially if exterior signage. A mall wet stamp must accompany the sign drawings for the Sign Permit Application to be accepted by the City.

Please contact the City of Cerritos Building and Safety Division for more information.

OPERATIONS AND UTILITIES

OPERATIONS

Tenant contractor parking and dumpster locations will be discussed at the preconstruction meeting. Contact the property's Operations Manager for more information.

SITE UTILITIES AND SERVICES

The following is an overview of the utilities and services typically available for in-line retail spaces. Please refer to lease language for any agreed upon changes that may overwrite these typical service provisions. It is the Tenant's responsibility to verify existing conditions and comply with all applicable codes and standards for all Technical systems.

I. ELECTRICITY

Tenant shell spaces typically provide conduit to a main power source.
Electrical use is directly metered with Southern California Edison.

II. DATA AND COMMUNICATIONS

Tenant shell spaces typically provide a conduit with pull string to nearest Granite rack.
Phone and internet services are provided on-site through Granite Grid.
Tenants must coordinate directly with Granite Grid to set up their data utility.
Other data providers do not have a right of access agreement and are not permitted access to the property.

III. SPRINKLER SYSTEM

Tenant shell spaces typically provide an automatic sprinkler system according to NFPA guidelines.
Tenants are responsible for contracting with the Landlord's required sprinkler vendor to adjust any existing grids, or install new if none exist, and tie into the main system.
Any modification to the sprinkler heads to be by landlord's required vendor at tenant's expense.

IV. FIRE ALARM SYSTEM

Tenants are responsible for contracting with the Landlord's required fire alarm vendor to install all code-required alarm, horns, strobes, conduit within the Tenant's space to tie into the Landlord's main fire alarm panels.

V. WATER

Tenant shell spaces typically provide domestic cold water stubbed into the space. Size and location of the pipe varies per space. Spaces also typically provide a sanitary line stubbed into the space or located under the floor slab. Size and location of the line varied per space.
Water use is metered and charged by the Landlord for retail Tenants. A separate account with a water utility company is usually not required, unless Tenant is a food use.

VI. HVAC

Tenants are required to furnish and install their own rooftop packaged units to provide HVAC to their space.

VII. GAS

Gas utility is not available for in-line retailers.
The property does have a centralized gas service room available for food-use Tenants only.

CONSTRUCTION > PRE-CONSTRUCTION / CLOSE OUT

CONSTRUCTION

The following is a brief overview of the construction process and requirements for a tenant build outs:

I. PRE-CONSTRUCTION

Prior to any construction commencement, the contractor's site superintendent is required to meet with the Landlord to review property construction requirements, submit construction documentation, and provide payment for property construction fees.

Required pre-construction documents include:

1. Landlord Approved CONSTRUCTION DOCUMENTS
2. Contractors Rules & Regulations to be completed and signed in full
3. Approved GC Certificate of Insurance
4. A copy of the Building Permit issued by the City
5. General Contractor's state license
6. Construction Progress Schedule
7. Subcontractor List (include associated trade, contact name and phone number)

The Landlord will send a Preparedness Letter detailing the fees required for collection prior to scheduling this pre-construction meeting.

II. CLOSE OUT

At construction completion, the Landlord will meet with the superintendent to perform a punch list walkthrough. The created punch list is required to be completed to the Landlord's satisfaction in order to close out the construction project.

To complete closeout, the following documents are required to be submitted:

1. Copy of Certificate of Occupancy or equivalent and Proof of Passing Final Inspections.
2. Final list of Subcontractors (please make any changes or additions from the list supplied at pre-con)
3. Unconditional Lien Waivers from all contractors, subcontractors and materials and service suppliers.
4. Notarized Affidavit from General Contractor stating that no liens exist as a result of Tenant's work.
5. Notarized AIA documents G702 & G703 (if the job is \$100,000.00 or more) / General Contractors Final Billing
6. AABC or NEBB Certified Air Balance Report
7. As-Built Documents (record set of what was constructed at the site, including Architectural, Structural, Mechanical, Plumbing, Electrical, Fire Protection, etc.) Electronic (PDF) format preferred.
8. Utilities Form

SUBMITTAL CRITERIA CONTENT OVERVIEW

6.1

CONSTRUCTION DOCUMENTS

CRITERIA FOR ARCHITECTURAL DESIGN REQUIREMENTS FOR RETAIL STOREFRONTS AND INTERIORS.

6.2

SIGNAGE DRAWINGS

CRITERIA FOR PRIMARY AND SECONDARY STOREFRONT SIGN DESIGNS.

The Submittals Criteria highlights the Landlord review process and drawing submittal requirements to ensure a quick and smooth drawing review for your design and **CONSTRUCTION DOCUMENTS**.

Tenant construction and signage drawings must be reviewed and Approved by the Landlord before the drawings can be submitted for permit. Permits from the local Municipality are required for all incoming Tenant construction and signage.

It is always the Tenant's responsibility to ensure:

- Compliance with the Lease document.
- Field verification of conditions and dimensions.
- Discrepancies between the drawings and the as-built conditions.
- Coordination with trades to ensure compliance with all local and national codes.



DRAWING REVIEW PROCESS

Drawing reviews are required to be submitted in two stages for Landlord review; Preliminary and final CONSTRUCTION DOCUMENTS. Preliminary drawings are required to ensure the design process moves quickly by ensuring that all Criteria requirements are understood and adopted early in the design. This helps ensure an expedited review of the final CONSTRUCTION DOCUMENTS.

REVIEW TIMELINE

Step	Action	Time Period
1	Tenant submits preliminary design.	Required 20 days after Lease Execution or 10 days following previous submittal disapproval.
2	Landlord Approved Preliminary Design.	15 days after confirmed completion of Step #1.
3	Tenant submits final construction drawings.	Required 20 days after Tenant Coordinator approval at Step #2.
4	Landlord Approves final documents.	15 days after completion of Step #3.
5	Tenant submits drawings for permit. (If applicable)	5 days after confirmed completion of Step #4.
6	Tenant responds to any requests from or comments by permitting jurisdiction.	5 days.
7	Upon permit review approval, Tenant pays all fees and logs out permit.	5 days.

> SUBMITTAL REQUIREMENTS > PRELIMINARY

PRELIMINARY DESIGN SUBMITTAL

The Preliminary Document review process will evaluate all the criteria discussed in this manual, including overall three-dimensional form, degree of design uniqueness and identity, use and detailing of materials, colors and lighting, and integration of signage and graphics.

Submittals are to provide the reviewer with a clear understanding of proposed design concepts.

The submission must be complete in order to fairly evaluate the proposal and prevent continuation of work on an unacceptable design.

Tenant shall submit to Landlord at tcsantamonica@macerich.com electronic PDF files of the following:

- **Color and Material Sample Board**
Include actual samples of all Tenant colors and materials visible to the public, on a digital sample board. Clearly label all materials and reference to floor plan elevations.
- **Perspective and/or Photo Image(s)**
Colored perspective rendering and/or prototypical photo images of the proposed storefront, including graphics and signage.
- **Cover Sheet**
Include: Name of Tenant, name of Mall or Center, space number, Applicable Codes, Building Type and Occupancy Type, Leased square footage, and Key Plan
- **Floor Plan**
¼." Scale Minimum showing: Entire lease dimensioned space with room names, floor finishes, casework and fixture locations.
- **Reflected Ceiling Plan**
¼." Scale Minimum showing: Lighting design, including fixture types and locations, signage, access panels, Overhead projections such as light coves and fascia systems, Entrance
- **Sections**
1" Scale Minimum showing: Entry, Display windows and fascia, Sign integration into storefront design.
- **Storefront Elevations**
½ Scale Minimum showing: Exterior views - front and sides, Signs, graphics, logos.

Copies of all drawings are to be sent to the Tenant Coordinator via email.

A physical sample board is also required, mounted on foam core or card stock to be sent in coordination with your Tenant Coordinator.

> SUBMITTAL REQUIREMENTS > FINAL

FINAL DRAWING SUBMITTAL

After Preliminary Drawing Approval, it is critical to quickly complete and submit Final CONSTRUCTION DOCUMENTS for Landlord review.

If any questions arise from the Tenant's interpretation of the design and criteria information, the Tenant shall assume all responsibility for clarification by written request to the Tenant Coordinator. The Landlord plan review and approval process is independent of local permitting for construction. The Tenant is responsible for procurement and compliance with local, state and federal codes and requirements.

Tenant shall submit to Landlord at tcsantamonica@macerich.com electronic PDF files of the following:

- **Responsibility Schedule**
Any work, which is the Landlord's responsibility, must be listed clearly on a responsibility schedule on the cover sheet.
- **Cover sheet**
Include a Key Plan, Name of Tenant, name of Mall or Center, space number and location leased premises within Mall or Center, Applicable codes, building type and occupancy type, Leased square footage, Responsibility schedule, and Drawing index.
- **Floor Plans**
¼" Scale Minimum showing: Entire lease space with room names, Floor finishes, casework and fixture locations, and Demolition plan.
- **Reflected Ceiling Plan**
¼" Scale Minimum showing: Complete lighting design, including fixture types and locations, signage, access panels, Overhead projections such as light coves and fascia system, Entry, Connection to Landlord's work, Tenant's framing and/or additional structure showing freestanding from Landlord's structure.
- **Sections**
1" Scale Minimum showing: Entry, Display windows and fascia, Sign integration into storefront design, Connection to Landlord's work, Tenant's framing and/or additional structure showing freestanding from Landlord's structure.
- **Interior Elevations**
¼" Scale Minimum showing: All sales floor interior views, Built-in casework, signage, and display systems.
- **Storefront Elevations**
½" Scale Minimum showing: Exterior views - front and sides, Signs, graphics, logos, Landlord neutral piers, Storefront finishes (to be referenced to finish schedule)
- **Architectural Details**
½" Scale Minimum.
- **Door Schedule**
Include floor transition details and anti-theft security system details.
- **Details, Catalogue Cut Sheets, and Fixture Finishes**
- **Finish & Color Schedule**

Copies of all drawings are to be sent to the Tenant Coordinator via email.

> SUBMITTAL REQUIREMENTS > FINAL ENGINEERING

FINAL DRAWING SUBMITTAL - ENGINEERING DRAWINGS

The Landlord does not review for mechanical, electrical, plumbing, or structural design, nor does the Landlord accept responsibility for the Tenant's adherence to governing codes.

Tenant shall submit to Landlord at tcsantamonica@macerich.com electronic PDF files of the following engineering drawings included in the final drawing set:

Copies of all drawings are to be sent to the Tenant Coordinator via email.

I. MECHANICAL DESIGN DOCUMENTS

- Make, type, and performance of all equipment.
- Sign and seal by a Licensed Engineer in the state where the Shopping Center is located.
- Calculations showing the heating and cooling required, including transmission and ventilation losses in the space, and heat and cooling provided for the ventilation supply, and exhaust required for the space. Calculations must be performed in accordance with the latest ASHRAE standards and tabulated in a concise, orderly manner.
- Temperature control system data showing make, control, and energy management systems.
- Exhaust system layout including CFM and equipment specifications.
- Reflected ceiling plan showing HVAC equipment.
- Roof plan with equipment locations.
- Structural details for support of all rooftop equipment and equipment suspended from the steel structure.

II. PLUMBING DESIGN DOCUMENTS

- Make, type, and performance of all equipment.
- Sign and seal by a Licensed Engineer in the state where the Shopping Center is located.
- Complete plumbing system design and floor plan for the Tenant space including, but not limited to the toilets, sinks, urinals, drains, hot water heaters, water coolers, grease trap/interceptors and connections into existing water and sewer lines.
- Single line diagram.
- Fixture schedule.
- Water heater detail as applicable.
- Grease trap cut sheets as applicable.

III. FIRE PROTECTION / SMOKE EVACUATION DESIGN DOCUMENTS

- Reflected ceiling plan, with revised sprinkler head locations.
- Design must be City approved before construction

IV. ELECTRIC DESIGN DOCUMENTS

- Sign and seal by a Licensed Engineer in the state where the Shopping Center is located.
- Panel schedules, load calculations, and meter information, if applicable.
- Structural drawings for all equipment that will be suspended from the steel structure.
- Electrical load summary and Title 24 Energy Calculations (for State of California).
- Floor plan depicting equipment locations and branch circuitry.
- Reflected ceiling plan depicting the layout of light fixtures.
- System one line diagrams.
- Lighting fixture schedule.
- Equipment legend.

V. STRUCTURAL DESIGN DOCUMENTS

- Design elements affecting the structure of the base building.
- Alterations, additions, modifications and reinforcements to the base building which shall be required to accommodate Tenant's Work.
- All calculations & details (Include ICBO numbers on all framing details, Seismic bracing details for State of California.)
- All forms required by governmental agencies and Governmental Regulations, fully and properly completed and executed by Tenant.
- Partial structural framing plan showing existing conditions for new and existing rooftop installations and proposed reinforcement, which shall be accompanied by structural engineers' calculations, drawn on a scale of 1/2"=1'0".
- Ceiling, soffits, storefront attachment details to existing base building.
- A letter from a state-registered structural engineer certifying that all new equipment and design elements serving the Premises are adequately supported to carry the new load.

SIGNAGE DRAWINGS > PROCESS & TIMELINE

DRAWING REVIEW PROCESS

Sign drawing reviews are required to be submitted in two stages for Landlord review; Preliminary and final CONSTRUCTION DOCUMENTS. Preliminary drawings are required to ensure the design process moves quickly by ensuring that all Criteria requirements are understood and adopted early in the design. This helps ensure an expedited review of the final CONSTRUCTION DOCUMENTS.

REVIEW TIMELINE

Step	Action	Time Period
1	Tenant submits preliminary design.	Required 20 days after Lease Execution or 10 days following previous submittal disapproval.
2	Landlord Approved Preliminary Design.	15 days after confirmed completion of Step #1.
3	Tenant submits final sign drawings.	Required 20 days after Tenant Coordinator approval at Step #2.
4	Landlord Approves final documents.	15 days after completion of Step #3.
5	Tenant submits drawings for permit. (If applicable)	5 days after confirmed completion of Step #4.

> SUBMITTAL REQUIREMENTS > PRELIMINARY, FINAL

PRELIMINARY DESIGN SUBMITTAL

The Preliminary Document review is intended to acquaint the Landlord with the Tenant's signage design intent.

Submittals are to provide the reviewer with a clear understanding of proposed design concepts.

The submission must be complete in order to fairly evaluate the proposal and prevent continuation of work on an unacceptable design.

Tenant's licensed sign contractor shall submit to the Center's Tenant Coordinator electronic PDF files of the following:

- **Perspective and/or Photo Image(s)**
Colored perspective rendering and/or prototypical photo images of the proposed storefront, including graphics and signage.
- **Storefront Elevations**
½ Scale Minimum showing: Exterior views - front and sides, Signs, graphics, and logos highlighting sign dimensions and materials.

FINAL DRAWING SUBMITTAL

After Preliminary Drawing Approval, it is critical to quickly complete and submit Final CONSTRUCTION DOCUMENTS for Landlord review.

If any questions arise from the Tenant's interpretation of the design and criteria information, the Tenant shall assume all responsibility for clarification by written request to the Tenant Coordinator. The Landlord plan review and approval process is independent of local permitting for construction. The Tenant is responsible for procurement and compliance with local, state and federal codes and requirements.

The Landlord does not accept responsibility for the Tenant's adherence to governing codes or verification of job site conditions.

Tenant's licensed sign contractor shall submit to the Center's Tenant Coordinator electronic PDF files of the following:

- Elevation of the storefront including signage and graphics; showing all doors, architectural features, etc., and fully detailed/dimensioned sections and details through the storefront.
- These fully detailed and dimensioned drawings shall be drawn to scale as noted:
 - Storefront Plan, Elevation and Sectional views at 1/2 inch scale.
 - Details of the Signage at 1/2 inch scale or larger.
 - Storefront Signage at 1/2 inch scale.
- Letter style and typeface specifics.
- Color and finish qualities of all portions of signage.
- Material specifications and thickness.
- Transformer specifications, including input and output voltage of transformers. PK housing, (or other UL approved insulating sleeve approved by Landlord and local building codes), is required for all through wall penetrations and must be indicated on the sign shop drawings. Wiring specifications.
- Locations of service switches, access panels and transformers. NONE of these items shall be visible to the public from any portion of the Mall.
- Neon tube specifications, including color and dimension (in mm) of tubes to be used.
- Type of lamps.
- Mounting hardware.

ADDENDUM LINKS

This Addendum contains links to supplemental documents of specific requirements and information. These documents are considered part of the Tenant Criteria Package. Clicking the links below will navigate to the described documents. It is the responsibility of the Tenant, its contractors, subcontractors, architects, engineers, employees, and agents to comply with terms of the Tenant Criteria, Addendum included.

GLOSSARY

I. [GLOSSARY OF TERMS](#)

Defines commonly used terms for clarity.

DESIGN ADDENDUM

I. [MACERICH SUSTAINABILITY HANDBOOK](#)

Guide to encourage energy efficient, sustainable design.

II. [UNIT UTILITIES AS BUILT CHECK LIST](#)

Helpful checklist for reference during a site survey.

III. [SPECIALTY LEASING CRITERIA](#)

Design requirements for temporary Tenant's buildout and signage.

IV. [MASTER SIGN PROGRAM AMENDMENT](#)

Guidelines for inline Seasonal and Pop up Signs as per the City of Cerritos.

KIOSK ADDENDUM

I. [CERRITOS CITY REQUIREMENTS FOR CART AND KIOSK SPACES](#)

Specific City of Los Cerritos design and dimension requirements for cart and kiosk Tenants.

BARRICADE ADDENDUM

I. [BARRICADE GUIDELINES](#)

Guide to installing and activating construction barricades with graphics.

CONSTRUCTION ADDENDUM

I. [CONTRACTOR RULES AND REGULATIONS](#)

Document detailing the rules and regulations Tenant contractors must adhere to during their construction. This document must be reviewed and signed by the Site Superintendent overseeing the Tenant build out.

II. [HOT WORK PERMIT](#)

Required form to submit when construction required hot work.

III. [PUNCH LIST](#)

Reference Landlord Punchlist that that Landlord will use to inspect and confirm completion of Tenant construction.

BUSINESS LICENSE/BUILDING PERMIT/SIGN PERMIT PROCESS

I. [BUSINESS LICENSE/BUILDING PERMIT/SIGN PERMIT PROCESS](#)

Explanation of the process for obtaining a business license, building permit, or sign permit needed for Tenant improvement projects. City websites for application submittal are included.