



 **FASHIONDISTRICT**
PHILADELPHIA

TENANT CRITERIA

MACERICH[®]

VISION STATEMENT

Welcome to Fashion District Philadelphia.

It is our vision and mission at Macerich to distinguish ourselves through superior performance in retail development and continuous improvement of our portfolio, to meet the changing needs of our customers and the retailers we serve. Our commitment is to furnish a well-designed, well-maintained and well-marketed retail environment, capable of maximizing traffic and sales.

We are pleased to become partners with retailers, striving for the same goals. We are ready to facilitate communication and share our expertise with you to complete your store within expected timelines.

These criteria act as a guide for the design of all work by Tenants in conjunction with the provisions of the Tenant's lease with the Landlord. Tenants are encouraged to express their own unique design statement within the parameters of the Design Criteria as outlined in this manual.

National and regional "standard" Storefront concepts are respected to the extent that they meet the Design Criteria. However, Tenants should be aware that some concept modifications might be necessary to comply with the Center's Criteria.

The same is true for proposed designs that are overly similar to a neighboring Tenant's Storefront design. We wish to make the Mall as diverse and interesting as possible and enable each Tenant to make a singular statement with their design.



CRITERIA MAIN CONTENTS

1.0

INLINE

CRITERIA FOR ARCHITECTURAL, SIGNAGE, AND TECHNICAL DESIGN FOR INLINE RETAIL LOCATIONS.

2.0

FOOD

CRITERIA FOR ARCHITECTURAL, SIGNAGE, AND TECHNICAL DESIGN FOR INLINE FOOD, FOOD COURT/HALL, AND RESTAURANTS.

3.0

BUILDING DETAILS

ARCHITECTURAL DETAILS, REQUIREMENTS AND REFERENCE PHOTOS BASED ON STORE LOCATION.

4.0

DESIGN INSPIRATION

SUGGESTED DESIGN MOTIFS AND INTRO TO KEY DESIGN ELEMENTS.

5.0

PROPERTY INFO

PROPERTY LOCATION, CONTACTS, UTILITIES OVERVIEW, OPERATIONS, AND LOCAL PERMITTING INFO.

6.0

SUBMITTALS

REQUIREMENTS TO SUBMIT CONSTRUCTION DOCUMENTS, RENDERS, SIGN DRAWINGS, AND MATERIAL BOARDS.

7.0

ADDENDUM

SUPPLEMENTAL DESIGN AND CONSTRUCTION REQUIREMENTS AND DETAILS PROVIDED AS LINKS TO EXTERNAL DOCUMENTS.



INTERACTIVE NAVIGATION

This Criteria is an interactive document. You may tap or click the top Navigation Bar or the Side Content Bar to navigate directly to that section.

This page serves as a hub to the various sections included in this Criteria.

The sections in this Criteria break down the key categories of information to understand the design and construction requirements to incorporate a successful retail experience. Refer to the overviews included in the left side bar to learn more about the content included in each section.

It is the responsibility of the Tenant, its contractors, subcontractors, architects, engineers, employees, and agents to comply with terms of the Tenant Criteria, including the supplemental documents included in the Addendum.

The intent of this Criteria manual is to:

- Accelerate the leasing process by providing quick answers to questions about specific requirements.
- Establish the design expectations and technical requirements.
- Establish a coherent design by carefully curating and integrating within the Center.
- Guide the design standards.
- Answer basic questions about the design and construction process.
- Save time by minimizing design reviews.



INLINE RETAIL CONTENT OVERVIEW

1.1

DESIGN

CRITERIA FOR ARCHITECTURAL DESIGN REQUIREMENTS FOR RETAIL STOREFRONTS AND INTERIORS.

1.2

SIGNAGE

CRITERIA FOR PRIMARY AND SECONDARY STOREFRONT AND WINDOW SIGN DESIGNS.

1.3

TECHNICAL

CRITERIA FOR TECHNICAL DESIGN ELEMENTS TO ENSURE YOUR STORE CAN INTERFACE WITH THE PROPERTY'S BASE BUILDING UTILITY SYSTEMS.

SECTIONS OF INTEREST

BUILDING DETAILS

Includes property reference photos and specific Storefront design details.

PROPERTY INFO

Includes information on the Property's building codes, area permitting, and required contractors.

SUBMITTALS

Outlines requirements on how and what to compile for submittals to the Landlord for design reviews.

DESIGN INSPIRATION

Provides visual inspirations for design aesthetics.

The Inline Retail Criteria provides key technical information and design requirements to ensure your store enlivens the consumer experience and interfaces with the Center.

The Tenant and the Tenant's Architect assume the following important obligations:

- Fulfill the intent of the Criteria both in concept and in detail.
- Determine and respond to the actual physical conditions of the Tenant's location.
- Maintain and enhance the high standards of quality established in the construction of the Center.
- Ensure the quality of execution of all design material, finish, and detail concepts in the construction of the Tenant's improvement.
- Provide the required detail at all transitions from Tenant Storefront to neighboring Storefronts, as well as to the base building.



DESIGN CRITERIA

STOREFRONTS

- ENTRY
- POP-OUTS / CONSTRUCTION

DESIGN CONTROL AREA

- DESIGN REQUIREMENTS / WINDOW DISPLAY / PROHIBITED DESIGN ELEMENTS

MATERIALS

- GLAZING / DECORATIVE GLASS
- WOOD / STONE / PLASTER / TILE
- METAL / LEATHER
- WALLCOVERINGS / SOLID SURFACE
- PAINT / FAUX FINISHES / FABRIC / TILE

INTERIORS

- LIGHTING / FLOORING
- CEILING / WALLS & PARTITIONS
- EGRESS DOORS / RESTROOM

SECTIONS OF INTEREST

- BUILDING DETAILS
Includes property reference photos and specific Storefront design details.
- PROPERTY INFO
Includes information on the Property's building codes, area permitting, and required contractors.
- SUBMITTALS
Outlines requirements on how and what to compile for submittals to the Landlord for design reviews.
- DESIGN INSPIRATION
Provides visual inspirations for design aesthetics.

Tenants are encouraged to express the individuality of their brand through excellent design by forward thinking design teams.

This Design Criteria focuses on strong design details visible from the Center common areas. Focusing on a strong Storefront design enlivens the retail experience and draws customers in to shop. Macerich's Design team is always excited to partner with Retailers in curating a unique and memorable shopping experience. Our team is available to collaborate on your enticing Storefront designs. The [DESIGN INSPIRATION](#) section is also a great launching point to explore design concepts and methods to engage customers.

- All Tenants must engage a reputable Architect.
- Design drawings must all be reviewed and Approved by the Landlord.
- All design elements and finishes must adhere to local and national building code requirements.



> STOREFRONTS

The Center's success is dependent on the creative design contributed by individual Tenants. It is vital that your Storefront design is integrated with the look and feel of the Center's aesthetic.

The [BUILDING DETAILS](#) section includes specific storefront design requirements based on your store's location. These location based requirements must be incorporated into your Storefront's final design.



> ENTRY

ENTRY

Your storefront entry is a critical design feature to create an invitation to shop, as such all stores must express the entry as an identifiable part of the storefront. The underside of the entry portal soffit shall be finished to match the storefront.

I. SWING DOOR ENTRY

- Swing doors should be located in a recessed vestibule a minimum of 3' from the storefront.
- No door swing shall project beyond the maximum allowable primary projection line.
- Minimum allowable door height is 9'-0".
- All other doors are to be hinged or pivot-type doors. Doors are suggested to be the height of the glazed storefront.
- Recessed entry flooring shall match the Centers' flooring requirements.

II. OPEN STOREFRONT ENTRY

- An open storefront must also present an entry zone. Macerich will review all open storefronts for alternate articulation and dimensional elements for all storefronts.
- Tenants choosing to have an open storefront are required to secure the premises after business hours with a coiling, sliding or folding security closure which comply with the following design guidelines:
 - Shall coil overhead or coil, fold or slide horizontally to retract into pockets or enclosures to conceal from view during business hours.
 - All supports, tracks, guides and operating devices must be concealed flush with adjacent storefront finishes when closure is in the open position and be integrated into the storefront overall design expression.
 - Horizontal tracks are not allowed in the floor surface.
 - Exposed locking devices or latches are not allowed. Key switches shall be concealed and mounted within the Tenant storefront proper.
 - All supports to be provided by Tenant. Suspending closures from existing building structure is not allowed.

Please note, The City of Philadelphia requires a Special Inspection form for structural attachment of a rolling grill entry assuring that that the structure has been reviewed and approved by a Structural Engineer.

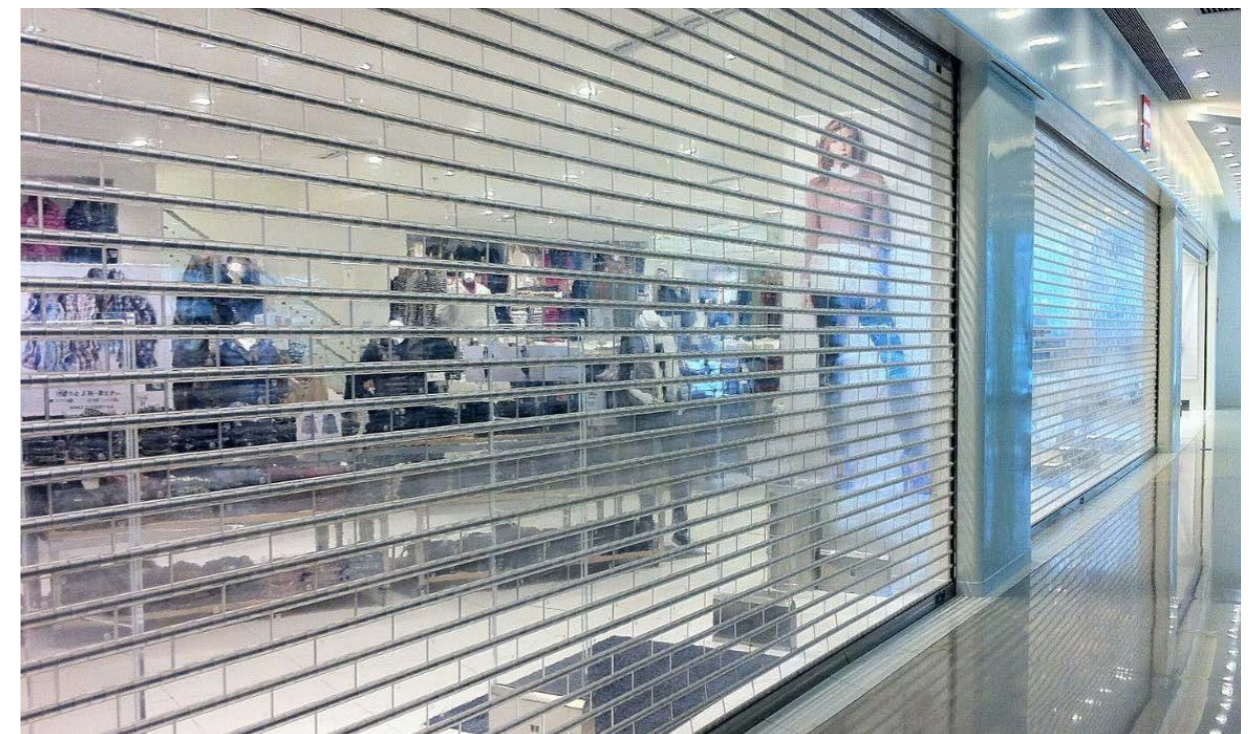

> POP-OUTS / CONSTRUCTION

POP-OUTS

Three dimensional pop outs in both plan and height are required for all Storefronts in all new Tenant areas.

- When Storefronts are visible from the upper level, special care must be taken so the top is finished to match the Storefront design.
- Refer to the [BUILDING DETAILS](#) section for pop-out dimensions specific to your store's location.
- Exposed conduits, raceways, access panels or equipment may NOT be visible.
- All surfaces of any visible projections must also be finished to match.
- No dust or falling debris may collect on surfaces visible from upper levels. Tenant is responsible for the upkeep of all surfaces.
- Designs may incorporate sloping tops at no less than a 3 in 12 pitch to create a debris resistant surface.

STOREFRONT CONSTRUCTION

- All storefront construction shall be self-supported from the floor and independent of the building fascia and bulkhead structure.
- Storefronts may be braced to the overhead structure within the Tenant space.
- Connections to the deck, mall mechanical, electrical, plumbing, or fire protection equipment for support is not permitted. This includes ceiling splay wires.



> DESIGN CONTROL AREA

The Design Control Area (DCA) is the zone extended from the storefront lease to six feet (6'-0") inside your space, including all display windows and retail graphics, display fixtures, signs, materials, finishes, color and lighting fixtures within the area.

At Macerich, we take special interest in the DCA as an extension of the retail presentation and showcase of the store's merchandising. The intent is to convey excitement, and give the consumer a reason to shop.

Use of a professional Visual Merchandisers is highly encouraged. Design drawings shall have a display layout plan. The layout plan shall have cut sheets for fixture and/or mannequin types and include photographs of any existing storefronts a Tenant may have that will enhance the layout plan. A rendering is required if photographs are not available.

Stores with both interior and exterior presence must activate both DCA areas. Tenants are encouraged to maintain open visibility into their store to draw in customers.



> REQUIREMENTS / WINDOW DISPLAYS / PROHIBITED ELEMENTS

DESIGN REQUIREMENTS

- Ceiling must be a hard surface.
- Lighting fixtures must be consistent with the character of the storefront design.
- Recess all lighting fixtures.
- A minimal profile track lighting system matching the color of the ceiling plane is allowed.
- Hard bases on the walls are required, including any permitted pop out areas.

WINDOW DISPLAYS

Displays should be deliberate and integrated into the Storefront. Modulation of display systems and built-in architectural components will reinforce the design.

- Display cases must be adequately lit and ventilated.
- Digital monitors are permitted within 10'-0" behind glazing if integrated into the design and approved by Landlord. Coordinate with Tenant Coordinator for exterior applications and to confirm code or local requirements.

PROHIBITED DESIGN ELEMENTS

- Temporary signs for sales or clearances shall not be hung in the DCA or affixed to the glass inside or outside.
- No pegboard, slat wall or metal shelving of any kind may be placed in or extend into any part of the DCA.
- Security devices or freestanding pedestals are not permitted. They must be integrated and concealed.
- Carpet, vinyl or rubber materials of any sort will not be permitted within the DCA.
- Exposure of incandescent bulbs and/or fluorescent tubes are not allowed.



> MATERIALS

As an important aspect of presenting the Tenant's unique brand image, finish materials are to be composed, articulated and executed in a creative and quality manner.

All materials and applied finishes on the Storefront are to be high-grade, durable, non-corrosive and code compliant. They are to be maintained by Tenant at the Tenant's expense. All materials and finishes are subject to Landlord approval, and the inclusion of natural materials is encouraged.

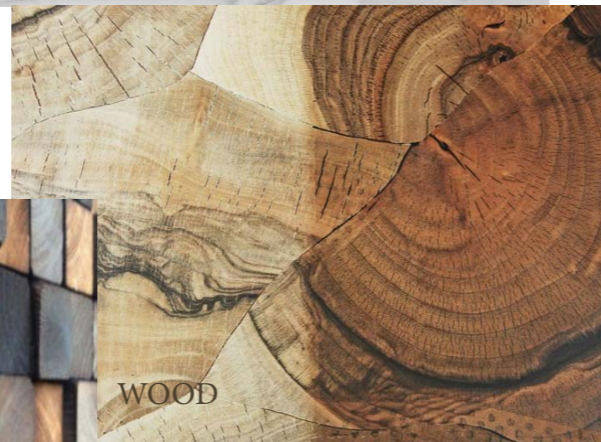

> GLAZING / DECORATIVE GLASS

GLAZING

Storefront glazing, particularly clear glazing, is a key component to establish design character and create an invitation for the customer to visit.

- A minimum of 60 % of the storefront is to be display windows with clear glass.
- Reflective glass (including extensive use of mirror) and/or tinted glass is not permitted on storefronts or in the storefront entry zone.
- Decorative glazing such as colored, beveled, sandblasted or etched glass may be used to create accent pattern and interest. Decorative glazing can be used as an accent, but must meet all material standards.
- All glass shall be tempered. Glazing must be a minimum of ½" thick, and large panes of glazing must be of sufficient thickness to meet code and be properly supported.
- Tenants may be required to provide seismic clips to stabilize tall expanses of glass. Silicone sealant at glazing joints is not permitted.
- Tinting or films applied after the glass is installed is prohibited.

DECORATIVE GLASS

Decorative glass may be considered to provide a unique feature to the storefront.

- In frame-less assemblies, glass panel joint details edges must be polished, ground or chamfered. Glazing channels at corner conditions must be mitered.
- All exterior glazing units must have a solar heat gain coefficient (SHGC) of not more than 0.27 and a U-value of not more than 0.28.
- Exterior glass must be a minimum of 1" insulated, low E units. 0.27 and a U-value of not more than 0.28.



> WOOD / STONE / PLASTER

WOOD

Wood material can be used for storefront construction but must comply with all local and national code requirements.

- Applications of painted or stained wood may include window frames, decorative trim, molding and solid areas, such as decorative bulkheads. In some cases, it may be used for larger architectural elements, such as columns and entablatures.
- Wood paneling and plank construction are not acceptable unless presented in a highly imaginative concept and approved by the Landlord.
- Wood specified for interior storefronts must be kiln dried, mill quality hardwood and must meet local flame spread requirements (Class III 76-200), as well as comply with all code requirements.
- Painted wood must have a shop quality enamel finish. Wood without a paint finish must receive a clear, preservative sealant.
- A mock-up of the materials, colors, textures, or application may be required at Landlord's discretion.

STONE

Granite, marble, limestone, travertine, slate, adoquin and other natural stone materials may be used for storefront applications.

Stone may be polished, unpolished, sandblasted, flamed, honed, split-face or carved.

- Natural stone must be protected against staining and discoloration by means of sealers appropriate to the material.
- Craftsman-like attention to detail is required at all connections and transitions to other materials, and we recommend utilizing metal reveals for a clean finish.
- Corner and edge details must prevent visible unfinished edges. Exposed edges must be quirk mitered, chamfered or polished to match adjacent surface finish.

PLASTER

Cement plaster (stucco) and Venetian plaster finishes may be considered for limited Storefront applications.

- Apply a finish texture as an even finish of light dash, sand or smooth finish.
- Plaster or stucco should not be the primary storefront material. Finishes should be used in combination with other high quality materials.



> METAL / LEATHER

METAL

Metal panel may be used to provide alternate texture on a portion of the storefront.

- High quality is expected for all metal applications, including careful finishing and quality fastener detailing.
- Metals may include: shop-painted aluminum and steel, stainless steel, solid brass, bronze, pewter, or enamel coated steel, and may be used for hardware, trim and panels when well designed and detailed.
- The following notes on metal material details must be called out on the submitted drawing set:
 - Minimum 1/2" thick fire-rated plywood or other solid substrate is required behind all metal panels.
 - Minimum 18 gauge metal panels are required.
 - All seams between metal panels must be identified on the storefront elevation and must be properly addressed during design review process.
- The following metal surface treatments are not allowed:
 - Oil canning (resulting from light reflection on an uneven or buckled surface)
 - Scratches
 - Warps, dents, occlusions
 - Visible seams or other imperfections
- Reveals, turn-in seams, welding or similar must be specified and detailed for approval. Metal panels will not be allowed to directly come into contact with adjacent panel or other materials.
- No visible fasteners are permitted.
- Lap joints and seams must be even, straight, and concealed when possible. Outside corners are to be mitered or continuous break shaped.
- Sealants on natural metals are required to prevent tarnishing and must be maintained by Tenant at Tenant's expense.



LEATHER

The use of leather "tiles" for vertical application can add a level of depth and texture to the Storefront. However, these tiles should not be used at an elevation that can be reached by the general population due to the delicate finish and to prevent damage over time.

- The Landlord recommends keeping the use of leather tiles on the Storefront above 7'-0" AFF.

> WALLCOVERINGS / SOLID SURFACES

WALLCOVERINGS

Wallcoverings can add depth and texture to Tenant Storefronts, but need to be applied accordingly based on the durability of the product.

Vinyl, Paper, or Fabric Wallcoverings are not considered durable and are expressly prohibited in the use of Tenant Storefronts.

- Any wallcoverings located at pedestrian level (below 7'-0" AFF) must be extremely durable and rated by the manufacturer for high traffic use.
- Any wallcoverings located above pedestrian level (higher than 7'-0" AFF) must be durable and washable for maintenance purposes.
- Removable/repositionable wall coverings are not permitted for Storefront use.
- All wallcovering applications must appear seamless and be securely affixed with commercial grade adhesive rated for high traffic use covering the entire back of the product.
- All maintenance of wallcoverings is by Tenant. No peeling, bubbling, or other separation of the wallcovering from the applied substrate is permitted to remain, and is the responsibility of the Tenant to repair in a time frame deemed acceptable by the Landlord.



SOLID SURFACE

The use of large format solid surface panels can effectively mimic luxury materials in places where cost may be an issue (IE: Caesar Stone or Cambria), or to provide even, diffuse lighting elements in the storefront (IE: Lumicor or 3Form).

- All solid surface products must be rated for heavy duty commercial applications – residential quality products are not permitted.
- Joints, flat seams, and corner conditions of solid surface materials must be tight and seamless.
- All visible edges must be finished to the same level and quality as the front face of the material.
- If the body of the product is not consistent throughout, a mitered corner detail is required to keep the presentation clean.
- All corners and edges must be eased for safety purposes.
- No adhesive can be visible in the final application.



> PAINT / FAUX FINISHES / FABRICS / TILE

PAINT

- Surfaces should be maintained as an even surface finish, at all times.
- Any paint application should show uniformity without evidence of touch-ups or batch variation.
- Paint should be colorfast, and well executed to prevent lap marks, brush marks, or poor coverage.
- Surfaces and materials shall be prepared and staged correctly to avoid problem conditions such as poor adhesion, sagging, chipping or flashing.
- Painted metal surfaces are not allowed.
- Painted gypsum board is not permitted on the storefront.

FAUX FINISHES

Faux finishes may be used at the Landlord's discretion.

- Actual samples of the faux finish must be submitted to the Landlord. Photographs of previous examples are helpful but may not be substituted for an actual sample.
- Faux finishes must be executed by a commercial artisan specializing in that medium.

FABRICS

- Fabrics shall be commercial grade and tested in accordance with ACT Guidelines.
- Specifics for flammability and four aspects of fabric durability: Wet & Dry Crocking, Colorfastness to Light, Physical Properties, and Abrasion are to be documented for each fabric specified and available for Landlord review if requested.

TILE

- Tile may be used in diverse applications and is encouraged to introduce light, texture, and graphic quality to a Storefront.
- Porcelain, cermaic, or glass tile in glazed or natural finishes may be used as accents and in limited field applications. Patterns over a large area must be sophisticated and well executed.
- Small intricate mosaic tile may be utilized for detail and accents only.
- Lapped or butt joints are not permitted. Outside cornered must be bull nose edge or special corner trim.
- Grout color should match the background color of the tile so as not to emphasise the grid.



> INTERIORS > LIGHTING / FLOORING

The store interior design should emphasize your merchandise and create an exciting experience for the customer.

It is the Tenant's responsibility to survey, capture and address all existing conditions within the space.

LIGHTING

Lighting can greatly contribute to the design of a Tenant's store, by emphasizing architectural forms as well as highlighting signage, adding color and visual drama to walls and other design elements. The creative use of dramatic lighting is encouraged at entries, show windows and merchandise displays.

- Fixtures must be positioned to avoid glare directed into public areas. Do not over light.
- Wall sconces or decorative lamping may be used to cast light onto storefront forms, provided that bare bulbs are not exposed and that the finish and form of these fixtures coordinate with the overall storefront design.
- Fixture cut sheets will be required to be submitted if this light form is used.
- Sconces shall be commercial grade in quality and size.
- Residential scaled sconces are not acceptable.
- Colors are subject to Landlord approval.
- 2'x2' or 2'x4' prismatic fluorescent lights are not allowed.

FLOORING

- Flooring is required in the full premises including in the recessed entry conditions and storage areas of the store.
- Stores with less than 800 sf. require finished flooring with hard surfaces.
- Hard surface base is required in all sales areas.
- Ensure floor material is durable.
- Carpet must be commercial grade and meet local code required fire-proof ratings.
- Exposed concrete floors must be sealed.
- Transitions between flooring and common areas must be flush.
- Tenant is responsible to mitigate any/all ADA issues and clear with the appropriate municipality.



> CEILING / WALLS & PARTITIONS

CEILING

- Recessed entry conditions must have a finished soffit matching the storefront.
- Concealed light covers to highlight architectural elements are encouraged.
- Multi-level ceilings are encouraged.
- Gypsum wallboard, concealed spline, decorative patterned ceiling panels, and other “high-tech” materials are encouraged.
- Standard 24”x48” acoustical panels are not allowed in sales areas.

WALLS & PARTITIONS

- Demising walls are not designed to accommodate cantilevered or eccentric loads. If Tenant plans to use a demising wall for support of shelf standards, light softs or heavy attachments, Tenant shall reinforce the wall as required by providing additional steel studs or independent supports for the shelf standards.
- Demising walls and ceiling shall be sound insulated to achieve a minimum STC rating of 50 by Tenants who produce above 80 dB (including but not limited to music stores, arcades, etc.) The Landlord will strictly enforce all Tenant’s right to quiet enjoyment of their Leased Premises.
- Tenant shall protect fire proofed columns and braces with gypsum board, and furr as required.
- The following are required for hair salons, pet shops and all food preparation type Tenants:
 - Walls containing “wet” areas to be constructed of metal studs with water resistant $\frac{5}{8}$ ” type “x” gypsum board.
 - Demising walls of pet shops shall have sheet metal installed on studs, behind drywall, up 3’-0” from floor.
- When Tenant chooses not to install a ceiling within Tenant’s stockroom, Tenant shall extend the partition separating the stockroom from other areas of the store, to the underside of the structure above in order to isolate the stockroom from the sales area attic space. Tenant to verify if this is allowed by code.
- Metal or plastic laminate inserts are required for slatwall. No visible substrate at slats.
- Recessed wall standards are permitted.
- No open shelving with visible brackets or surface mounted systems are allowed.



> EGRESS DOORS / RESTROOM

EGRESS / SERVICE DOORS

- All secondary exit doors shall be backset so that the door does not swing into the corridor, or exit passageway.
- Doors entering a common exit passageway or corridor shall be labeled with the Tenant name and space number.

RESTROOM

- Toilet facilities shall be designed in compliance with all applicable ADA & Building Department Codes.
- Provide a 3" floor drain and cleanout.
- Each restroom must have an exhaust system.
- Floor finishes in toilet rooms shall be ceramic tile with a covered 6" base. Tenant is required to provide a waterproof membrane beneath the finish floor surface up to a height of 4" along all walls.
- Toilet room walls and ceiling shall be constructed of metal studs with water-resistant 5/8" type "X".



SIGN CRITERIA > CONTENTS

- PRIMARY SIGNAGE**
 - CONTENT / DESIGN ELEMENTS*
 - PLACEMENT / DIMENSIONS / CONSTRUCTION*

- SECONDARY SIGNAGE**
 - WINDOWS / THRESHOLD*
 - AWNINGS / DIGITAL DISPLAYS*
 - BLADE SIGNS*
 - PROHIBITED ELEMENTS*

- EXTERIOR SIGNAGE**

SECTIONS OF INTEREST

- BUILDING DETAILS**
Includes property reference photos and specific Storefront design details.

- PROPERTY INFO**
Includes information on the Property's building codes, area permitting, and required contractors.

- SUBMITTALS**
Outlines requirements on how and what to compile for submittals to the Landlord for design reviews.

- ADDENDUM**
Includes additional info on exterior signage requirements.

Storefront signs are vital to the successful function of the Center.

The goal of this Criteria is to produce a colorful collage of signage that tastefully informs, delights, and stimulates the shopper.

All sign materials must be consistent with the design theme, enhancing the storefront and evoking a positive retail image.

Due to the variety of architectural treatments within the Center, each Storefront sign will be carefully considered in relationship to its particular location. What may be appropriate in one location may not work in another. Each proposed sign will be evaluated on its originality and compatibility with neighboring signs, and its overall image within the Shopping Center.

The Landlord reserves the right to disapprove any sign design that is not compatible with these criteria and the aesthetics of the Shopping Center.

This Criteria is intended to harmonize with the leasing documents. It is the responsibility of the Tenant to forward a copy of these Criteria to their architect, contractor and various consultants.

No deviation from the enclosed Criteria requirements will be accepted without prior written approval from Macerich.

Signage design and construction must be code compliant.



> PRIMARY SIGNAGE

Your primary sign is an opportunity to express your Brand's identity and individuality at the entry portal of your store.

The following sign types are encouraged as design options for your primary signage:

- **REVERSE CHANNEL (HALO LETTERS)** minimum of 3" deep and projected from the background.
- **INTERNALLY ILLUMINATED** sign housings having unique shapes with letters routed out and formed letters protruding beyond the routed out letter.
- **EDGE-LIT, SANDBLASTED GLASS** with a continuous light source.
- **CAST METAL LETTERS** raised or flush with the fascia surface.
- **GOLD LEAF** on glass or stone.
- **SILK-SCREENED** glass or metal panels.
- **INDIRECT ILLUMINATION** on non-internally illuminated signs (artisan type panel signs).

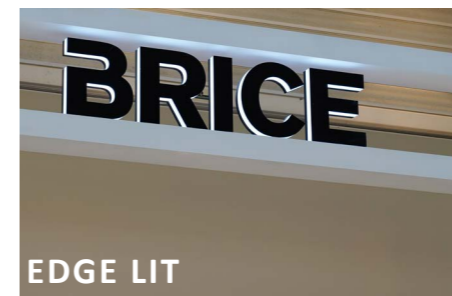

> CONTENT / DESIGN ELEMENTS

SIGN CONTENT

- Sign wording is limited to the Tenant's trade name and shall not include specification of merchandise sold or services rendered, regard-less of the Tenant's legal name. Corporate crests, logos or insignia may be acceptable pending the Landlord's approval and provided they are part of the Tenant's name.

SIGN DESIGN ELEMENTS

- All primary Storefront signs must be illuminated. External illumination designs are subject to Landlord approval.
- Imaginative signs utilizing a variety of materials are encouraged. Adaptation of current sign practices may be necessary in order to comply with these criteria.
- Backlit components must be contained wholly within the depth of the letter. Maximum brightness may not exceed one hundred (100) foot-candles.

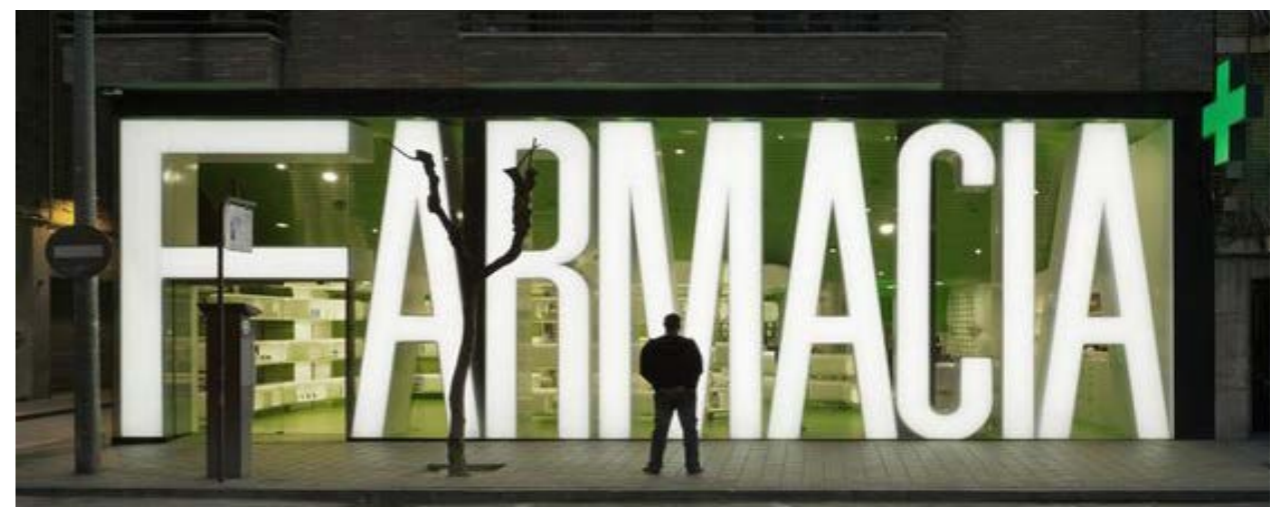

> PLACEMENT / DIMENSIONS / CONSTRUCTION

SIGN PLACEMENT

- One sign is permitted per store frontage unless additional signage is approved by Tenant Coordinator. Tenants occupying corner spaces may utilize one sign per elevation with a maximum of two (2) signs, or one sign on a diagonal corner. For unusually long tenant Storefronts, more than one sign may be allowed, with Landlord approval.
- Bottom of sign to be at 9'-0" A.F.F. minimum.

SIGN DIMENSIONS

- Signs shall be designed as an integral part of the storefront, with letter size and location proportional to the overall storefront design, and in compliance with the Design Criteria.
- Letter size: must be proportional. Max allowed for height of letter is 13% of overall storefront height. Example - a storefront that is 12'-0" in height will be allowed to have a maximum letter height of 18.72".
- Letter dimensions of greater proportions may be considered if, in the Landlord's opinion, the sign design is of exceptional merit and architectural quality.

SIGN CONSTRUCTION/INSTALLATION

- All Storefront signage and lighting both interior and exterior is required to be on a separate circuit and controlled by a time clock. Storefront Signage and lighting are required to be on during operating hours and off during non-operating hours. This includes exterior building storefront signage.
- Electrical raceways are not to be visible.
- High quality fabrications are required. Hums, flickers and light leaks are not permitted. Attachment devices, bolts, clips, threaded rods, fasteners, tubes, raceways, conduit, and other mechanisms are to be concealed. All labels must be away from public view. Signs must comply with all codes and regulations, must bear the UL label, and must have current sign permits.
- Tenant may use Landlord bulkhead for lateral bracing only.
- Threaded rods or anchor bolts shall be used to mount sign letters spaced out from background pane. Angle clips attached to letter sides will not be permitted. All bolts, fastenings, and clips shall be of hot-dipped galvanized iron, stainless steel, aluminum, brass or bronze, and no black iron materials of any type shall be permitted.
- Advertising placards, banners, pennants, names, insignia, trade-marks and other descriptive material may not be attached to the storefront or glazing.
- Visible weep holes are not permitted.
- Any existing holes from previous Tenant signage must be patched and painted.



In addition to the Primary Sign, all Signage visible from the exterior of the store are considered Tenant Signs. These do not include messages used to advertise products, sales, or special events. Several various Secondary Signs are allowed at the Center and detailed in this section.

The following general Secondary Sign requirements must be met by all Sign varieties:

GENERAL

- Signs must be kept within the projection.
- Signs must be in proportion to the overall storefront and composition.

MESSAGING

- Trade name and logo only, are allowed.
- No taglines may be incorporated.
- Established logos will be allowed and will be counted in the overall area calculations.



> WINDOW / THRESHOLD

Secondary signage types and their requirements include:

STOREFRONT WINDOW SIGNS

If the Tenant wishes to provide additional tenant identity, it is to be located at the pedestrian level on the inside face of the storefront glass.

- Glazing signs are to be translucent (similar to frosted glass), reverse-reading and applied directly to the interior of the glass surface.
- Tenant graphics on storefront glass shall be computer cut fat vinyl graphics (text/letter/logos)
- Maximum allowable area of signage is subject to Landlord's review and approval.
- Tenant graphics/logo will be limited to a maximum of three (3") inches in height.

THRESHOLD SIGNS

In addition to storefront signs, Tenants are encouraged to incorporate signs into their entry way flooring. Landlord will review threshold signs on an individual basis.

- Threshold signs are to be graphics comprised of logos, crests and accent.
- Finish is to be flush with adjacent materials and consistent with entry flooring quality.
- Recommended materials are wood, tile, stone, metal and terrazzo inlays.
- Threshold signs are not to extend beyond their lease line into the Center.



> AWNINGS / DIGITAL DISPLAYS

AWNINGS

Some Tenant Storefront designs include projected awnings. Landlord will review awnings and their signage on an individual basis.

- Glass or metal are the preferred materials of choice, although fabric awnings will be considered.
- Awning signage may be considered as the main Tenant's identification at the sole discretion of the Landlord in the interior of the Mall only.
- Signage may occur on the valence of the awning and may be painted or silk screened in a contrasting color.
- Logos shall be silk-screened and submitted with awning and sign drawings. Size of the logo shall be proportionate to the overall width of the awning and subject to Landlord's approval.
- The lowest point of the awning or shade shall be a minimum of eight feet (8'-0") above the finished floor. It is the designer's responsibility to ensure that awnings conform to all applicable codes.
- Materials such as Pana-flex, plastic or other vinyl materials shall not be permitted.
- Awnings shall be cleared and maintained in good condition at the sole expense of the Tenant
- Wording on awnings is limited to Tenant's DBA only.

DIGITAL DISPLAY

Storefront window digital display signs must meet the following requirements:

- The display is integrated into the Storefront design.
- Pole mounted monitors are not permitted.



> BLADE SIGNS

BLADE SIGNS

- Blade signs are permitted at the Landlord's discretion.
- Signs must be illuminated.
- Bottom of sign shall be a minimum of 9'-0" from the finished floor.
- Material must be high quality material such as wood, metal, or glass.
- All Blade signage must incorporate one of the two bracket design options (square or rectangle) detailed on the following pages.

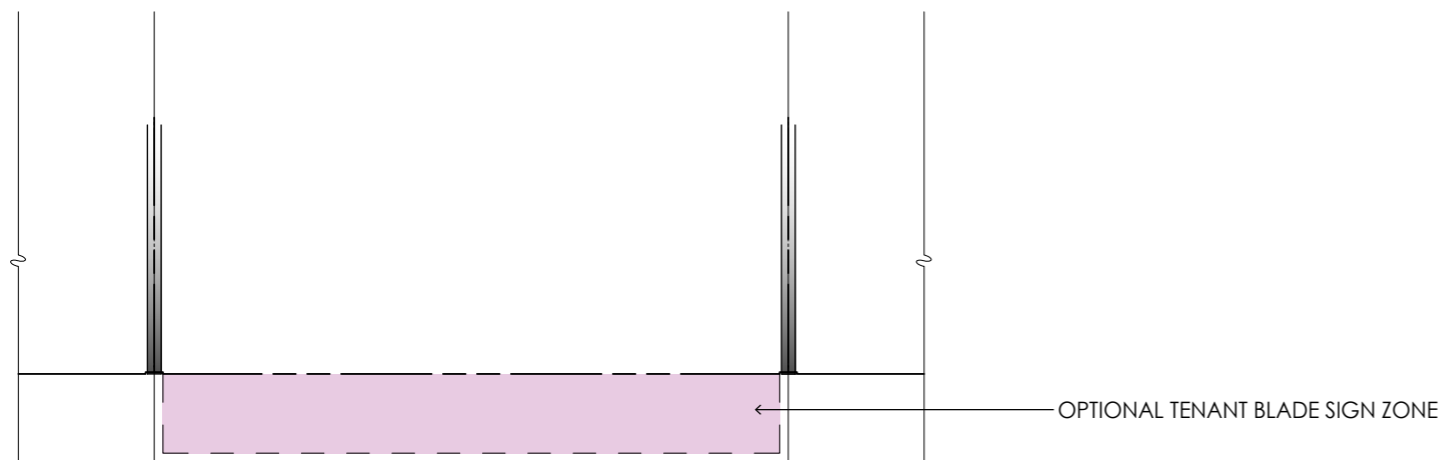
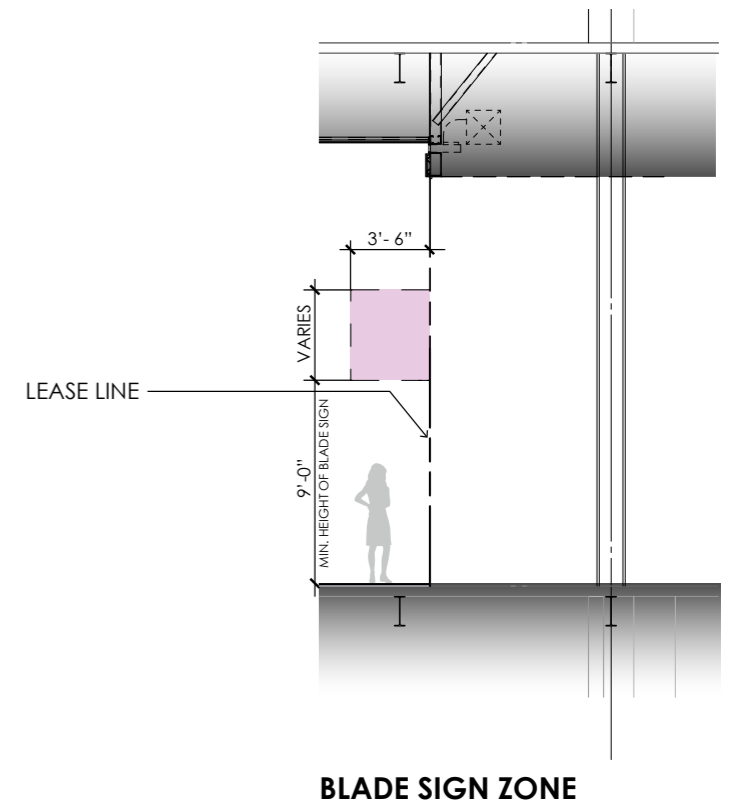
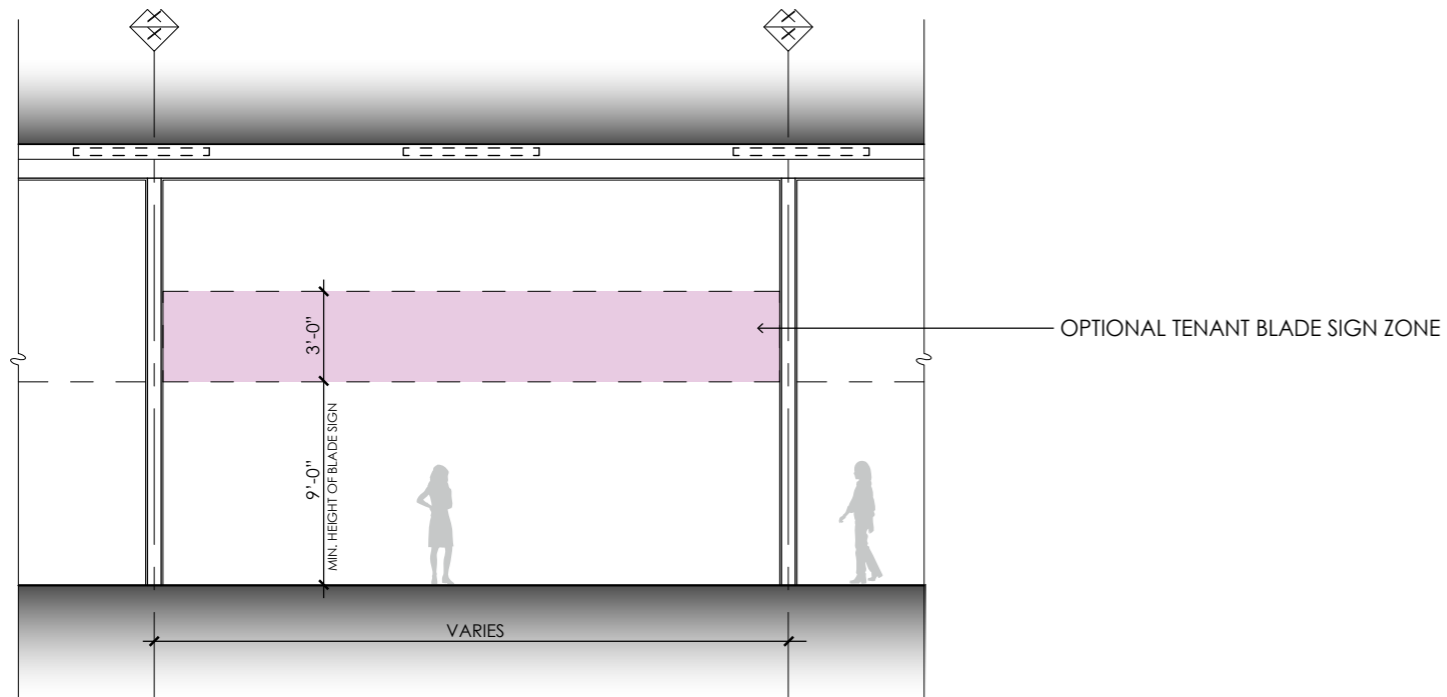

RECTANGULAR OPTION

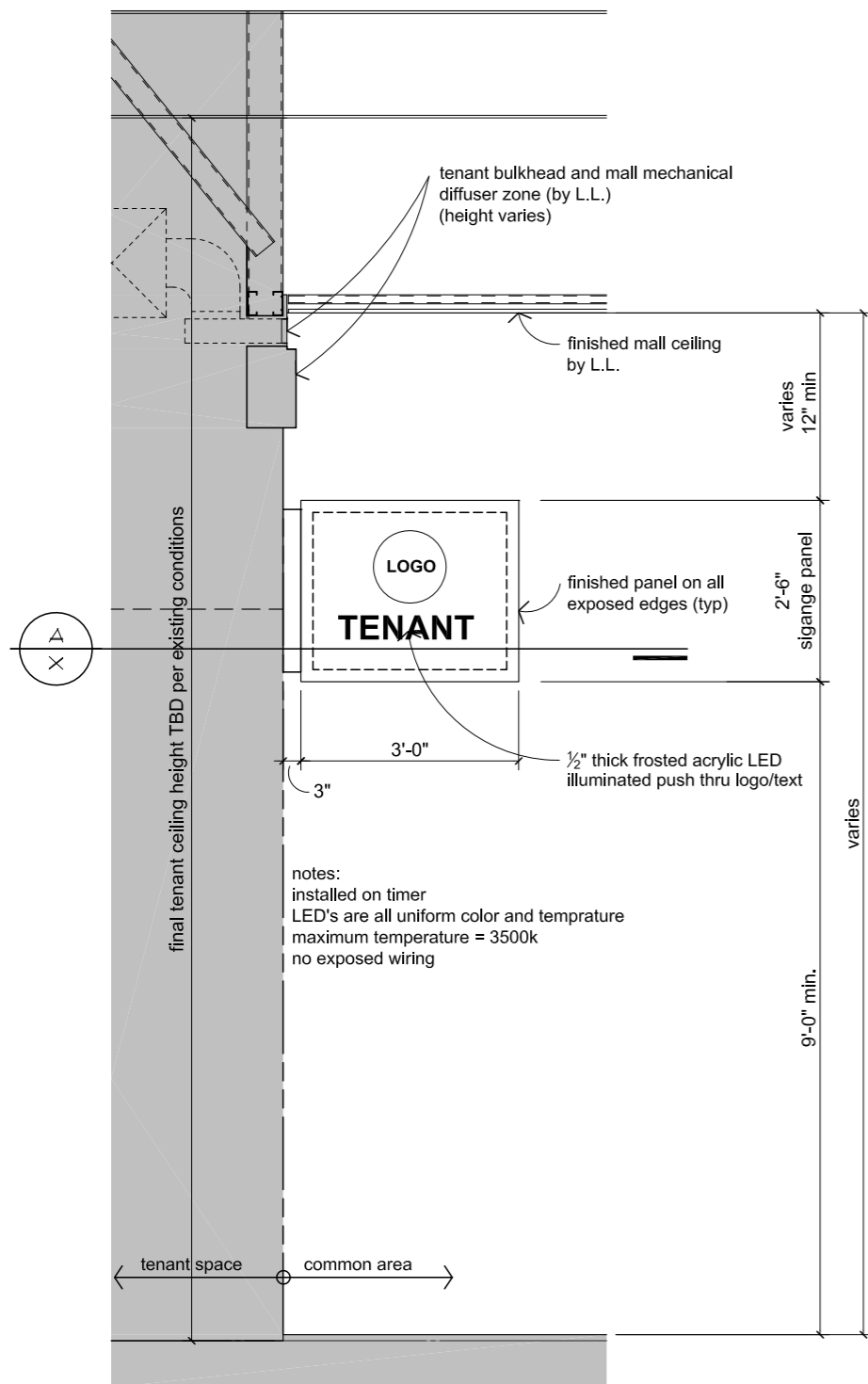

Section @ Lease Line / Tenant Storefront
scale: 1/2"=1'-0"

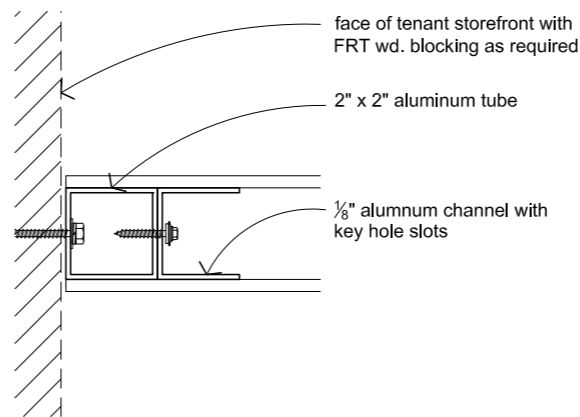

C Plan Detail
scale: 3"=1'-0"

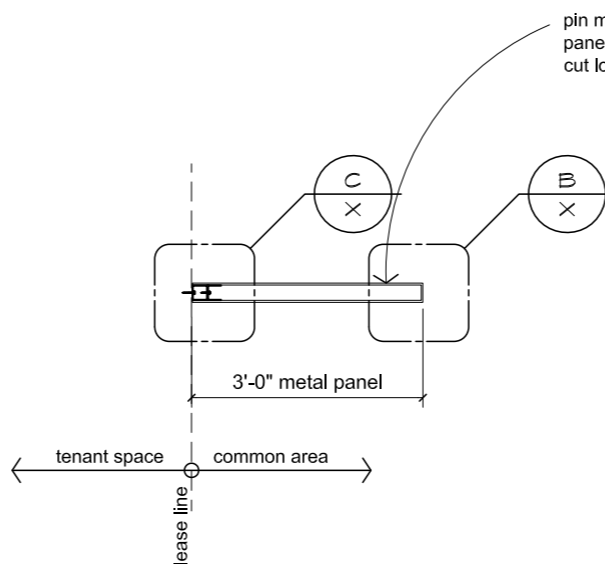

A Plan Detail
scale: 1/2"=1'-0"

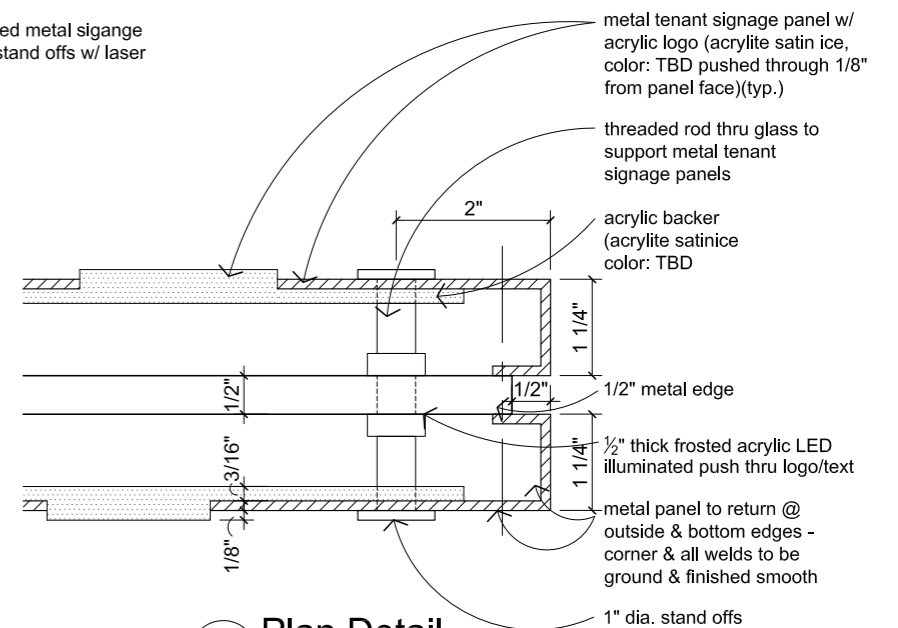

B Plan Detail
scale: 6"=1'-0"

USE OF TENANT BLADE SIGNS SHALL BE AT THE SOLE DISCRETION OF LANDLORD

SQUARE OPTION

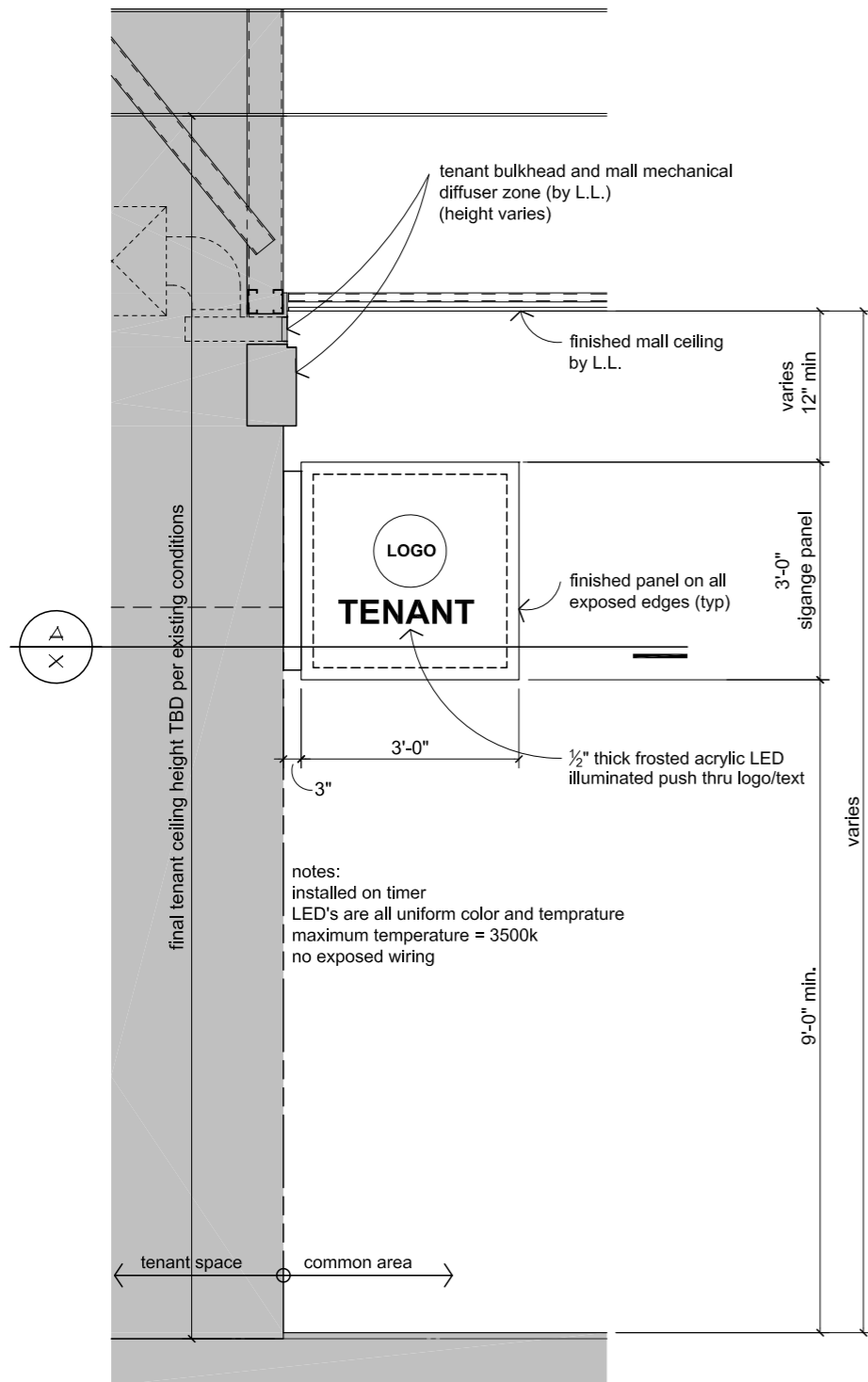

Section @ Lease Line / Tenant Storefront
scale: 1/2"=1'-0"

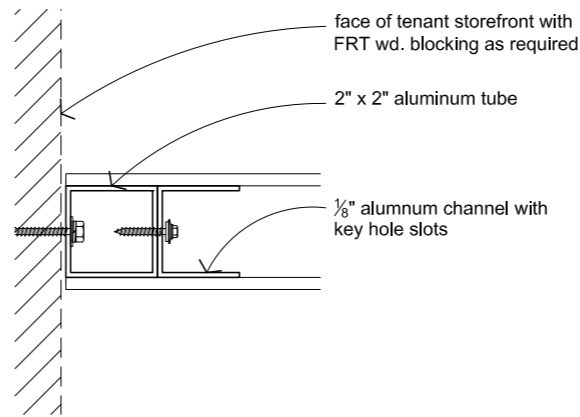

C Plan Detail
scale: 3"=1'-0"

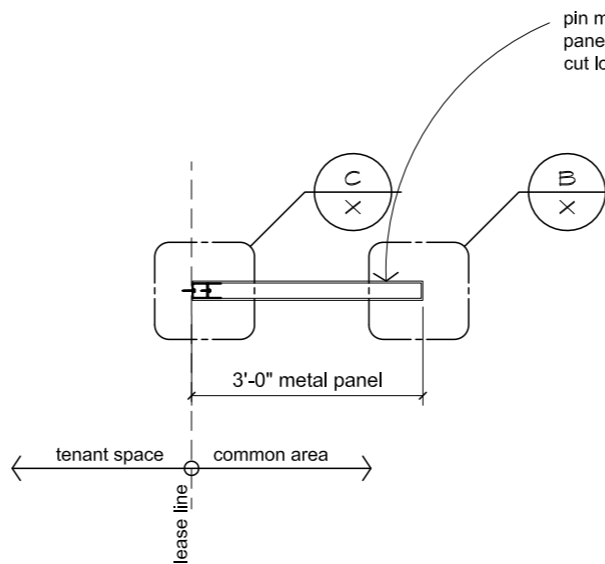

A Plan Detail
scale: 1/2"=1'-0"

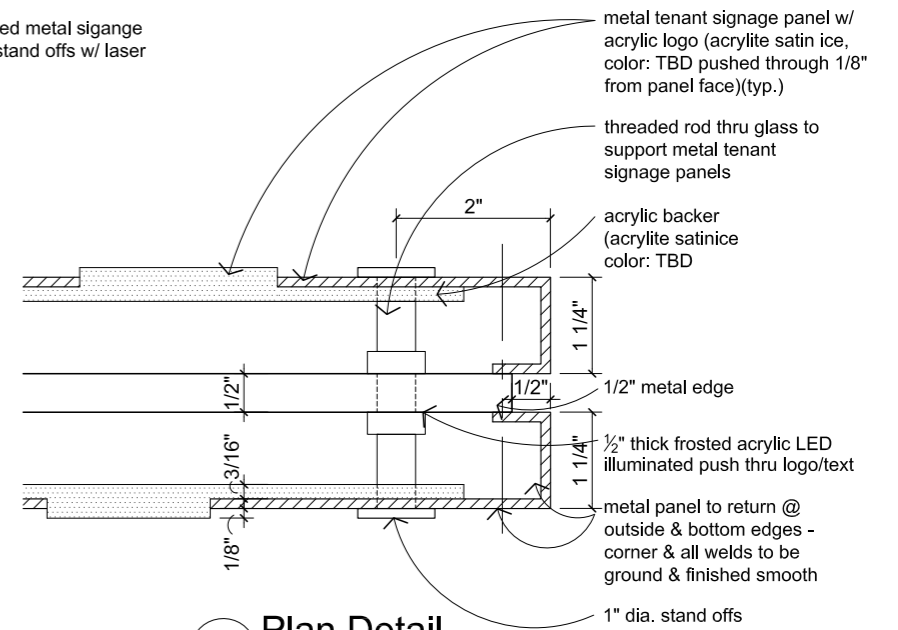

B Plan Detail
scale: 6"=1'-0"

USE OF TENANT BLADE SIGNS SHALL BE AT THE SOLE DISCRETION OF LANDLORD

BLADE SIGN - SQUARE OPTION
PRELIMINARY - FOR OWNER REVIEW 3-14-18

> PROHIBITED SIGNS AND MATERIALS

PROHIBITED SIGNS AND MATERIALS

The following sign types and materials are not permitted:

- Internally illuminated plexi-faced channel letters.
- Vacuum-formed or injection-molded plastic signs.
- Cabinet or standard “can type” signs with illuminated translucent backgrounds and silhouetted letters.
- Exposed skeleton neon applied directly to fascia element.
- Temporary or ‘sales’ signs attached to storefront.
- Freestanding tripod signs.
- Flashing, scintillating, moving, sequencing, audible or odor producing signs.
- Paper, cardboard and Styrofoam signs.
- Credit card and advertising placards, decals, stickers or trademarks.
- Manufacturer labels.
- Carpet or rubber entry mat signs.
- Internally illuminated awnings.
- Signs employing un-edged or uncapped plastic logos or letters with no returns and exposed fastenings.
- No simulated materials (IE: wood grained plastic laminates, Zolatone etc.) or wall covering permitted.

SIGN CRITERIA > EXTERIOR SIGNAGE

Exterior Signage is design, dimensions, locations, and construction are all closely monitored and approved by the City of Philadelphia.

For specific requirements and guidelines for exterior signage, refer to the [EXTERIOR SIGNAGE CRITERIA](#) linked here and highlighted in the [ADDENDUM](#).



TECHNICAL CRITERIA > CONTENTS

- ELECTRICAL**
 - POWER SOURCE / METER*
 - REQUIREMENTS / SYSTEM REUSE*
 - DATA & COMMUNICATIONS / LIGHTING*
- LIFE SAFETY**
 - SPRINKLER*
 - FIRE ALARM*
 - EGRESS*
- PLUMBING**
 - METER / REQUIREMENTS*
 - GAS*
- MECHANICAL**
 - GENERAL REQUIREMENTS / EXISTING SYSTEMS / EXHAUST*
 - ROOFTOP EQUIPMENT*
 - VAV BOX CONTROL SYSTEM AND DETAILS*
- STRUCTURAL**
 - BUILDING DETAILS*
 - REQUIREMENTS*
 - SLAB DETAILS*

SECTIONS OF INTEREST

- BUILDING DETAILS**

Includes Property reference photos and specific Storefront design details.
- PROPERTY INFO**

Includes information on the Property's building codes, area permitting, and required contractors.
- SUBMITTALS**

Outlines requirements on how and what to compile for submittals to the Landlord for design reviews.
- ADDENDUM**

Includes additional info on exterior signage requirements.

The Inline Technical Criteria provides buildings details and design requirements for the Center's technical systems.

It is the Tenant's responsibility to verify existing conditions and comply with all applicable codes and standards for technical systems.

Tenants are required to adhere to the full Criteria during their design and construction.

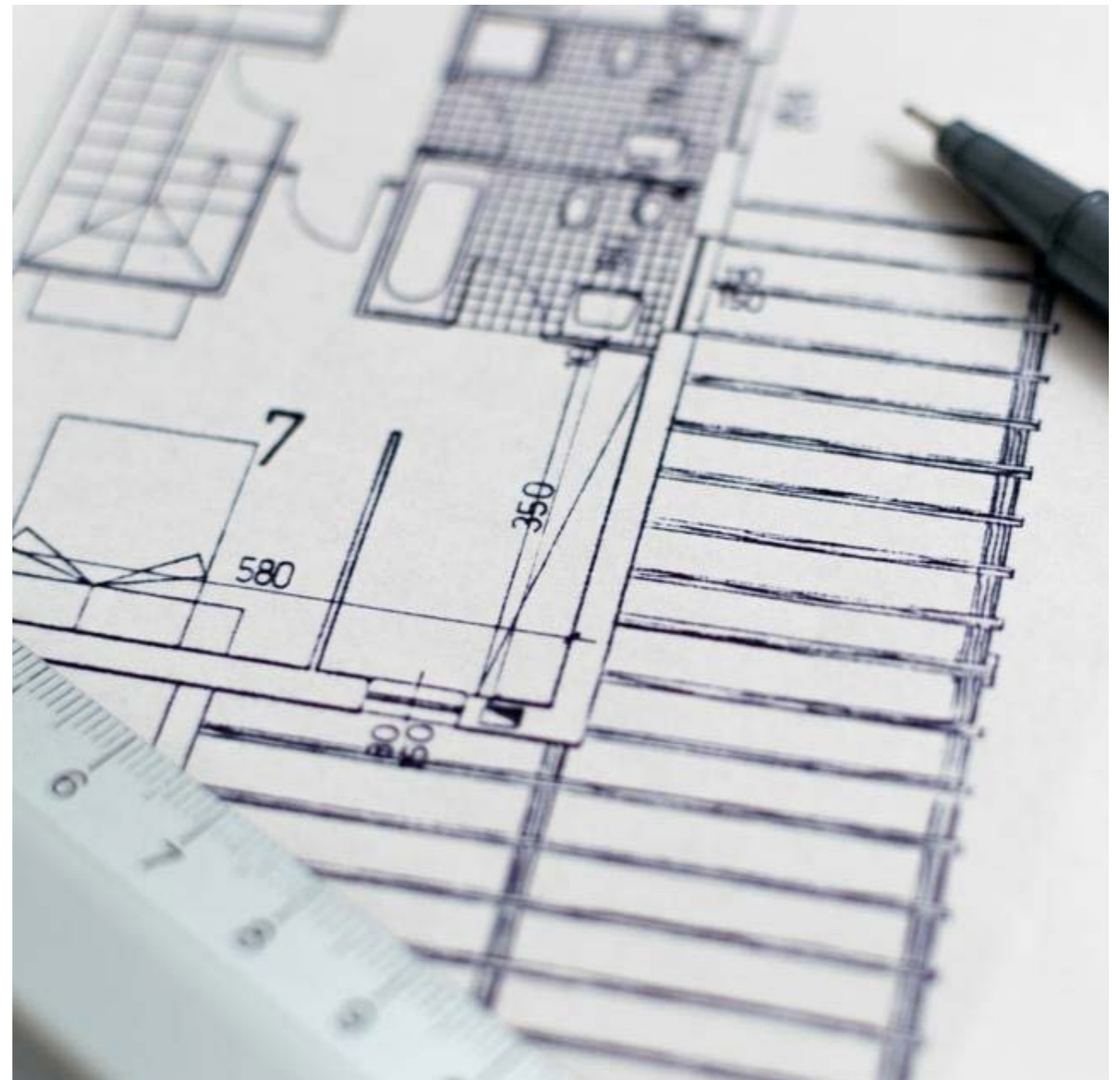

> ELECTRICAL > POWER SOURCE / METER

PROVIDED POWER SOURCE

Tenant shell spaces typically provide an empty conduit to a main power source.

The main power source available for Tenant connections will be 277/480v, 3 phase, 4 wire available from the nearest electrical room.

Power is allocated for each Tenant based off of 15 Watts per square foot.

The Landlord may provide temporary electrical service to the Tenant, during construction. The charge for this temporary power will be paid by the Tenant as per the Tenant Construction Rules and Regulations. Temporary wiring needed to work in the space should be connected to the Tenant's electrical service and not common area outlets.

I. TENANT REQUIREMENTS

Tenants are required to meet the following requirements related to connecting to their power source:

- **MAIN POWER SOURCE CONNECTION** must be performed by the Landlord's designated electrician, at the Tenant's expense.
- **FEEDERS** to the tenant space are the Tenants responsibility, installation of a dry type transformer, panels and complete distribution throughout their space.
- **LARGER CONDUIT**, if required, is a Tenant responsibility to install from the power source to the demised premises.

METER DETAILS

Electric Meters are Eaton Power Expert Multipoint Meters with BACNET IP communications protocol. They are integrated into the base building tenant distribution panels.

I. EXISTING METERS

If there is an existing electric sub-meter in the Tenant's space:

- **RECOMMISSIONING** the meter is the Tenant's responsibility to ensure proper installation and functionality or;
- **NEW METER** may be installed by the Tenant that meets Macerich's meter specifications. Either option must be performed by a Landlord-approved electrician and verified by Macerich, and will be at the Tenant's sole cost.

> REQUIREMENTS / REUSE

SYSTEM REQUIREMENTS

- **NO DIRECT ATTACHMENT** to the slab, roof deck, ductwork, piping or conduit above. Conduit and raceway hangers, clamps, light fixtures, junction boxes, supports, etc. must be fastened to joists and/or beams.
- **ACCESS PANELS** must be provided at all junction box locations and at smoke detectors above the ceiling.
- **IDENTIFY** all Tenant equipment in the Mall electric room with clear labels that include the Tenant name and space number.
- **TENANT EQUIPMENT** typically includes, but is not limited to: all outlet boxes, floor boxes, wire raceways, power/telephone poles, plug-in molding, wiring devices, and hanger supports for a complete distribution must be furnished and installed by Tenant.
- **EQUIPMENT POWERED BY TENANT** typically includes, but is not limited to: VAV units, water heater, store fixtures, signage, music systems and any other fixtures or equipment provided by Tenant.
- **CUTTING AND PATCHING** must be provided by Tenant.
- **FEEDERS** are typically the Tenant responsibility to the Tenant space.
- **UL LABELS** on all material and equipment must be new and of a commercial grade and where such labeling applies.
- **WATERTIGHT FLOOR BOXES** are required.
- **PULL BOXES/J-BOX MATERIAL** must be a minimum of 12 gauge galvanized steel outlets. Boxes in walls must be galvanized pressed steel or case metal. Caulk around boxes to eliminate noise transmission.
- **CONDUCTOR INSULATION** to have 600 volt insulation type THW, THWN or THHN.
- **CONVENIENCE RECEPTACLES** must be specification grade, 120 volt, 20 amps and be grounding type per NEC.
- **CONTROLS** including Manual or magnetic starters, switches, contactors, relays, time switches, safety devices, dimmers and other controls must be commercial type with heavy duty ratings and must be installed in strict conformance with the manufacturer's recommendation and applicable codes.

- **EXPOSED WIRING** is not permitted. All wiring of any type must be installed in conduit or must be metal clad cable (MC). Metal clad cable will only be allowed for concealed branch circuit wiring within the demised premises. Flexible conduits must be used for connections to vibrating equipment.
- **EXPOSED LOW VOLTAGE** wiring must be plenum graded.
- **COPPER** is required for all wiring.
- **CONDUIT** is required for all wiring, including low voltage.
- **SLAB TRENCHING** is not permitted without written permission from the Landlord. Tenant to provide all structural support needed if trenching is permitted, including written certification to the Landlord that the trenching has not affected the integrity or weighty capacity of the slab.
- **GRADE LEVEL SLAB** requires electrical conduit to be installed at least 4" under the slab with Schedule 40 PVC conduit. Conduit must not be installed in the slab or less than 4" below slab.

REUSE OF EXISTING ELECTRICAL SYSTEMS

Tenant's electing to re-use the existing electrical system (if applicable) in their Tenant space shall:

- **SUBMIT A LETTER** to the Landlord from the Tenant's electrical engineer stating that the existing electrical system is not being altered.
- **VERIFY SYSTEM CONNECTS** to the building management system for lighting controls and Fire Alarm. Tenant shall use mall required contractor at Tenant's expense to ensure code-compliant, connected system is complete.

> DATA & COMMUNICATIONS / LIGHTING

DATA AND COMMUNICATIONS – INSTALL AND PROVIDER REQUIREMENTS

Telecommunications service is provided and administered throughout the Center by Granite Grid. The service includes a dedicated concierge customer service representative for each Tenant, high-bandwidth service (tailored to suit Tenant demand), centrally coordinated installations, moves and repairs.

- **ACCOUNT SETUP AND SERVICE INSTALLATION** is the Tenant responsibility to coordinate direct through Granite Grid. Other data providers are not permitted at this property as they do not have an access agreement in place. ****It is highly recommended to coordinate service install a minimum of 4 weeks in advance**
- **TELEPHONE DEMARC WORK** must be performed by Landlord's approved telephone subcontractor.
- **TELEPHONE SERVICE** is the Tenant responsibility to contact the local Telephone Company and install within their premises.

LIGHTING – SYSTEM REQUIREMENTS

- **LIGHTING IN TENANT SPACE** is the Tenant's responsibility. The Tenant will not install any lighting outside the Tenant's space with the exception of Mall required standard lighting at back doors. These fixtures shall be photo cell controlled.
- **LIGHTING SCHEDULE** is required for review in conjunction with a reflected ceiling plan.
- **TIME CLOCK** is required to control display window lighting and be on during the hours the Shopping Center is open.
- **DISPLAY WINDOW LIGHTING** at the ceiling must be glare-free and at approved levels at the storefront glass line and not hang down below the top of storefront glass.
- **RECESSED INCANDESCENT DOWN LIGHTS** are permitted.
- **DECORATIVE LIGHTING FIXTURES** for storefront illumination, such as luminous ceilings, chandeliers, pendant or wall units or clear type glitter strips are permitted if approved by Landlord. No strobe, spinner or chase type lighting shall be used.
- **CODE REQUIRED LIGHTING** such as exit, emergency and night lights must be provided throughout.
- **SALES AREA FLUORESCENT LIGHTING** must be recessed and must use metal parabolic louver type lenses with a minimum of 18 cell configuration for a standard 2' x 2' fixture. Bare lamp fluorescent or fluorescent fixtures with acrylic prismatic lenses may be used only in concealed areas or stock rooms.
- **TRACK LIGHTING** may be used if the track is painted to match the ceiling color.
- **LIGHTING CONTROL SYSTEM** is the Tenant responsibility, including connection to the Building Management system and connection to the Fire Alarm system.

> LIFE SAFETY > SPRINKLER / FIRE ALARM / EGRESS

SPRINKLER SYSTEM REQUIREMENTS

- **SPRINKLER MODIFICATIONS** are the Tenant's responsibility, designed and installed in accordance with NFPA 13.
- **SPRINKLER DESIGN AND INSTALLATION** must be performed by the mall required sprinkler contractor.
- **PIPING** must be as close to walls and as high to underside of roof framing as possible.
- **LANDLORD NOTIFICATION** is required in writing at least 24 hours in advance of making any modifications to the sprinkler systems. Contractor must notify the fire department and any alarm monitoring company for verification that the system is fully drained. The contractor must notify the Landlord when the system is back on line.

FIRE ALARM REQUIREMENTS

- **FIRE ALARM DETECTION SYSTEM** is a Tenant responsibility to provide within the Tenant space as an extension of the Landlord's building-wide addressable fire alarm system.
- **FIRE ALARM INSTALLATION** must be performed by the Landlord's designated contractor.
- **FIRE ALARM TIE-IN** to the building wide addressable system must be performed by the Landlord's designated contractor.
- **OCCUPANT NOTIFICATION** must be provided within tenant spaces (on a tenant-by-tenant basis) that exceed the Code's thresholds based on the occupancy classification of the individual tenant space.

EGRESS REQUIREMENTS

- **FIRE BARRIER FROM ADJACENT SPACE** must be separated by at least 1-hour fire barriers with 60 minute opening protectives.
- **FIRE BARRIER FROM EXIT STAIR DISCHARGE** must be separated by 2-hour fire barriers with 90 minute opening protectives.
- **AUTOMATIC SPRINKLER SYSTEMS** must protect passageways.
- **SMOKE DETECTION SYSTEM** must protect passageways.
- **GAS PIPING**, if distributed along the exit passageway routes, will be separated from the exit passageway by fire rated construction and will not be considered to be located within the exit passageways.
- **ALLOWED UTILITIES** in exit passageways are limited to; Electrical wiring (no higher than 480 volts phase-to-phase and 277 volts phase to-neutral) in electrical conduit, Low-voltage wiring (security, music, telephone, data, etc.), enclosed junction boxes, Fire alarm equipment and wiring, Noncombustible piping, and Mechanical ductwork.
- **PROHIBITED UTILITIES** in exit passageways include; Electrical equipment such as panels, switchgear, and transformers, Grease traps, and Natural Gas piping.

> PLUMBING > METER / SYSTEM REQUIREMENTS

SYSTEM OVERVIEW

Tenant shell spaces are typically provided a domestic cold water line and sanitary line stubbed into the space.

The following criteria must be followed during the design and construction of the Tenant space:

WATER METER DETAILS

To properly interface with the Building Automaton System, the water meter is required to be:

- No-lead positive displacement type with magnetic drive and pulse output.
- Compliant with AWWA C708 and ISO 4064 Class B standards.
- Equal to DLJ100C 1" with pulse for monitoring 1" line, DLJ150C 1 1/2" with pulse for monitoring 1 1/4" and 1 1/2" lines DLJ200C 2" with pulse for monitoring 2" with pulse for monitoring 2" line, or DLJ250TC with pulse for monitoring 2 1/2" line.

Water meters can be purchased by contacting:

Daniel L. Jerman Co.
1-800-654-3733
www.watermeters.com

SYSTEM REQUIREMENTS

- **SHUT OFF VALVE** located at eye level in a wall behind a labeled access door is required. Locate in or near employee restroom and/or as designated by Landlord.
- **COPPER** is required for all domestic supply lines and condensate lines.
- **ELECTRIC WATER HEATERS** are required for domestic hot water.
- **SANITARY VENTS** through the roof shall be a minimum of 4" and extend a minimum of 8" above finish roof. All roof repairs to be by the Landlord's required roofer at Tenant's expense.
- **ABOVE GROUND SANITARY VENTS** (other than food waste) must be service weight BUILcast iron, with fittings matching the same weight as the pipe.
- **FLOOR DRAINS** are required in the toilet room and in all "wet" areas.
- **WATERPROOFING** must be installed in all "wet areas" such as kitchens, restrooms, mop sinks, drinking fountains, etc. The waterproof membrane must extend 4" vertically on all demising walls. This membrane will be water tested by the General Contractor and inspected and signed off by Mall Personnel. If the membrane fails the water test, it must be replaced.
- **CLEAN OUTS** must terminate flush with the finish floor or wall. No clean outs are permitted above the ceiling. Floor or wall cleanouts must be provided every 50' with ready access.

WATER METER REQUIREMENTS

- **INSTALL** must be by a Landlord approved electrician.
- **VERIFICATION AND APPROVAL** of install must be obtained by the Operations Manager, or a member of the Operations staff at the property.
- **PROOF OF INSPECTION** sent to the Tenant Coordinator including:
 - Date of installation or recommissioning
 - Meter make and model
 - Picture of the meter at time of installation or recommissioning
 - Units that the meter reads in
 - Multiplier, if applicable
 - Confirmation that the meter covers whole tenant space
- **GARBAGE DISPOSALS** are not allowed.
- **HAIR SALONS/PET SHOPS** must provide hair and solids interceptors on all sinks and basins which may receive human or animal hair. After installation, these hair interceptors shall be properly maintained so as to keep the sanitary system free from any adverse conditions. A maintenance contract with Mall-approved vendor is required to be submitted for record with Mall Operations.
- **HAIR RECEPTORS** must be installed on all sinks, basins, and special sanitary units which may in any way receive human or animal hair.
- **KITCHEN SINKS** including pot sinks, scullery sinks, pre-wash sinks and other kitchen units must be connected to a grease trap.
- **DISHWASHERS** may not be connected to grease trap.
- **GREASE INTERCEPTOR** must be designed and approved by Landlord prior to installation, especially if located outside the lease line.
- **OIL COLLECTION AND HAULING SYSTEM** is required for Tenants with fryers or other grease/oil generating equipment that does not run through an interceptor. Landlord does not provide a centralized collection point.

> SYSTEM REQUIREMENTS

- **BACKFLOW PREVENTERS** are required for food service, hair salons or other Tenants with equipment or operations that have the possibility of backflow. These must be certified and acceptable to the water district and checked yearly or as required by the local authority having jurisdiction.
- **BACKFLOW PREVENTERS** are required for food service, hair salons or other Tenants with equipment or operations that have the possibility of backflow. These must be certified and acceptable to the water district and checked yearly or as required by the local authority having jurisdiction.
- **FLOOR PENETRATIONS AND PLUMBING** by Tenants on the upper level must be coordinated with lower level Tenants and the Landlord. Tenant will be responsible for all costs associated with this work. Tenants must submit calculations to the Landlord which show the size selection or basis of capacity of all equipment and piping.

- **WATERLESS URINALS** are required in tenant restrooms when urinals are used.
- **LOW-FLOW WATER CLOSETS** using 1.6 GPF or less gallons per flush are required where water closets are used.
- **OPERATION SENSORS AND LOW-FLOW HEADS** using 0.5 GPM or less are required if Tenant is installing a Restroom.
- **CARRIER FIXTURES** are required for Second level Tenant locations above the Street require carriers for the bathroom fixtures.

 Yellow locations below provide sanitary lines roughed into rear wall.

 Blue locations below provide sanitary lines roughed into the demising wall.

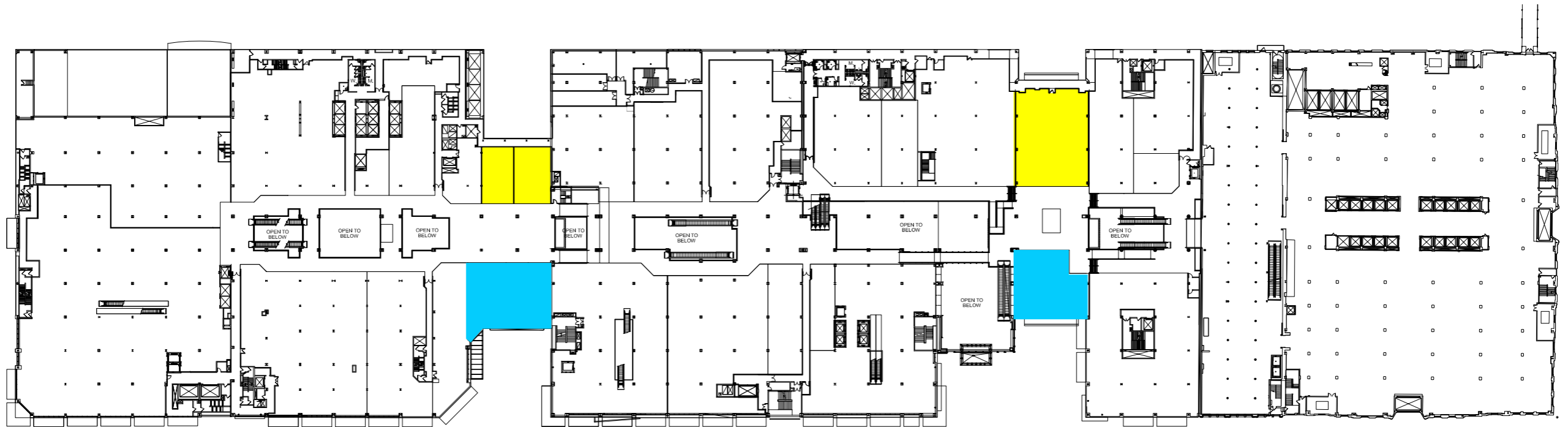

 Yellow locations below provide sanitary lines roughed into rear wall.

 Blue locations below provide sanitary lines roughed into the demising wall.

> GAS

GAS SERVICE

Gas is not available to Retail Tenants. All heating of water and air conditioning systems must be accomplished through electricity. Gas is only available for food-use Tenants that require gas cooking equipment.

I. SERVICE REQUIREMENTS

- **GAS METER INSTALLATION** at gas meter header is the responsibility of the Tenant.
- **GAS PIPING INSTALLATION**, when allowed, is the responsibility of the Tenant to provide and install. Roof piping must be placed on pillow blocks or similar arrangement. All roof repairs to be by the Landlord's required roofer at Tenant's expense.
- **PRESSURE REGULATORS** required for connection to Tenant's equipment is the responsibility of the Tenant. Coordinate with Landlord for regulator vent routing.

> MECHANICAL > GENERAL / EXISTING / EXHAUST

Tenant shell spaces typically provide a supply duct delivering 1.0 CFM per square foot of conditioned (Approximately 55 degree) forced air. The conditioned air is supplied from a Central Plant. The central plant does not operate in the winter between roughly November 15th and April 15th each year. During the season when the central plant is not in operation, outdoor air is utilized for cooling. Tenants are responsible for the control and distribution of air within their space using electric reheat VAV boxes.

Spaces also typically provide an exhaust stub with an allowance of 150 CFM for Tenant restrooms.

Make-up air (outdoor air) is provided per the rates listed in Chapter 4 of the 2009 edition of the International Mechanical Code for retail occupancy.

GENERAL REQUIREMENTS

- **VIBRATION ISOLATORS** are required to be installed on all HVAC equipment, whether on the roof or within the Tenants space.
- **MAXIMUM NOISE** criteria of NC40 is required for all spaces except kitchens and other similar work areas.
- **DUCT MOUNTED SMOKE DETECTORS** are required for systems that total 2,000 CFM or greater and must be connected to the main fire alarm panel, if applicable. Each duct smoke detector must have a remote key operated reset/test device mounted with in the Tenant space and an addressable relay module. Use Landlord's designated contractor for connection to the main fire alarm loop. The cost associated in monitoring Tenant's space will be the Tenant's responsibility and will be included in Tenants monthly billing.
- **AIR BALANCE REPORT** is required prior to closing out construction and will be performed by an independent test and balancing agency at the sole cost and expense of the Tenant.
- **BOTTOM FED HVAC** units are required for supply and return air.
- **CONDENSATE LINES** from HVAC units must be copper, run at right angles, drain into the Tenant space, and (if applicable) secured to the roof per mall required roofer's specifications.
- **RETURN AIR DUCT** must be from the finished ceiling back to the HVAC unit. Ceiling return air plenum is not acceptable.
- **FIRE DAMPER ASSEMBLIES** (including sleeves and installation procedures) must be UL listed and approved by the building inspector preceding installation. Install duct and ceiling access to fire dampers. Smoke detectors may be required in all return air or exhaust ductwork. The detectors will over ride and shutdown the air handling equipment when smoke is discovered.
- **FIBERGLASS DUCTS** are not permitted for HVAC trunk lines. Flex duct is permitted for run outs within the Tenant premises and is limited to a maximum distance of 4'.

EXISTING SYSTEMS

The Lease may allow some Tenants to resuse existing HVAC system equipment. In such cases, the following requirements must be followed:

- **CONFIRM** the existing system meets the Tenant Criteria requirements.
- **REPLACE** any units the Landlord deems in need of replacing. This may occur anytime during the terms of the Lease. Replaced units must adhere to the Tenant Criteria.
- **REUSE** of equipment older than 5 years is not permitted.
- **ALTERATION** of the existing system must be submitted and approved by the Landlord.
- **SUBMIT DOCUMENTATION** of the following prior to opening:
 - A letter from an HVAC contractor asserting that the HVAC unit(s) operate in "like-new" condition.
 - A copy of the maintenance agreement for the unit(s).
 - Photographs of the existing unit(s) provided by the Tenant's HVAC maintenance contractor.

EXHAUST REQUIREMENTS

- **ODOR PRODUCING TENANTS** such as restaurants, pet shops, hair salons, nail salons, and the like must maintain 10% negative air pressure with respect to the Mall by providing make-up air equal to 90% exhaust air volume.
- **SEPARATE MAKE-UP OUTDOOR AIR SYSTEM** may be required to balance Tenant's exhaust system. Spaces that require exhaust must be designed to provide negative air pressure relative to adjoining conditioned spaces to prevent odor transfer.
- **ROOF MOUNTED EXHAUST FANS** must be ducted to ceiling grilles located approximately in the center and rear of the demised premises and specifically near the area where the odors are generated. The system shall be designed to cause the exhaust air to gravitate from the Mall common area to the odor producing area and then exhausted out.
- **EXHAUST FANS** must be interlocked with the light switches for the store customer service area.
- **OPERATION** of the combined HVAC and exhaust system must be on during all hours that the Tenant is open for business.
- **STORE EXHAUST SOLUTIONS** shall not include air filtration systems or bathroom exhaust fans.

> ROOFTOP EQUIPMENT

ROOFTOP EQUIPMENT REQUIREMENTS

- **LOCATION** of rooftop equipment, if required, must be directly above the demised premises as designated by the Landlord.
- **PIPING** for the rooftop equipment must be provided and installed by the Tenant in coordination with the Landlord.
- **INSTALLATION INFRASTRUCTURE** including all curbs, supports, lintels, pipes, ducts, vent caps, air inlets, exhaust hoods, louvres, flashings, counterflashing's, etc. are the Tenants' responsibility.
- **CURB ADAPTERS** are not permitted.
- **EQUIPMENT SCREENS** for rooftop shall meet Landlord requirements.
- **PAINTING EQUIPMENT** including screening, equipment, ductwork, and piping is required to match the roof deck per Landlord specifications.
- **ROOF MEMBRANES** are required for mounted grease exhaust equipment and shall be a single 60mil sheet of TPO roof membrane, loose and laid over the base mall primary roof membrane. This additional sheet of TPO shall be installed minimum 5' beyond all roof top kitchen equipment and help in place by concrete pavers at the corners and or as required to keep the membrane in place and afford the ability to replace as necessary when it becomes soiled.
- **LABELS** are required on all Tenant equipment.
- **ABANDONED EQUIPMENT** must be fully removed, including any associated curbs and patched accordingly.

I. ROOFTOP WORK

- **MALL APPROVED ROOFING CONTRACTOR** is required for all roof work throughout the center.
- **WARRANTY COMPLIANCE** is the responsibility of the Tenant and mall roofing contractor.
- **ROOF ACCESS** shall be coordinated and scheduled through Mall Operations.
- **DAMAGE** to the roof structure caused by hoisting installation and the maintenance and/or servicing of Tenant's equipment will be the sole cost and expense of the Tenant to repair.
- **QUALITY OF WORK** is subject to inspection by the Landlord and, if found unsatisfactory, will be rejected.

> VAV BOX CONTROL DETAILS AND REQUIREMENTS

VAV BOX DETAIL

The base building system is designed with a VAV box basis of design of a TRANE single duct box with 460v / 3hp / 60 Hz electric heat, 30% minimum airflow.

Tenants shall install VAV boxes based on this basis to ensure their system functions in harmony with the base building systems.

VAV BOX CONTROL REQUIREMENTS

- **MONITORING AND CONTROLS** are the Tenant responsibility to provide for each VAV box serving their space through the Landlord Building Automation System (BAS), for optimization in conjunction with the associated Landlord air handling unit.
- **BUILDING BAS SYSTEM TIE-IN** is required for Tenant systems using the mall required contractor.
- **VAV CONTROLS** shall be designed and installed according to a specific sequence of operation detailed in the following section.

CONTROL SEQUENCING REQUIREMENTS

The following control programming parameters must be used to interface with the Base building systems:

I. GENERAL CONTROLS

- VAV boxes are monitored through the BAS using direct digital controls (DDC) with electronic actuation. Each VAV box includes an airflow “cross”, modulating butterfly damper, and 1-stage to 3-stage electronic heating coils.
- VAV box dampers will fail in their last position upon loss of power.
- VAV boxes will be controlled in the following modes: Occupied Mode, Unoccupied Mode, Warm-Up Mode, Cool-Down Mode
- Control of the VAV boxes and associated air handling units will be indexed to occupied or unoccupied mode as scheduled through the BAS. Control of each VAV box and associated air handling unit may be overridden from unoccupied to occupied mode for the local occupancy override time set point by momentarily pressing the corresponding push-button on the associated space temperature sensor. The VAV boxes will be controlled using the following initial user-adjustable schedule:
 - Monday through Saturday Occupied Start Time – 10:00 AM
 - Monday through Saturday Occupied Stop Time – 9:00 PM
 - Sunday Occupied Start Time – 10:00 AM
 - Sunday Occupied Stop Time – 7:00 PM
- VAV box setpoints will be adjusted through the BAS. The heating and cooling setpoints for each VAV box may be adjusted up or down together over the local setpoint adjustment range through the corresponding push-buttons on the associated space temperature sensor. The VAV boxes will be controlled using the following variable, including user-adjustable and active (program-adjusted) setpoints:
 - Occupied Heating Setpoint (72° F)
 - Occupied Cooling Setpoint (75° F)
 - Unoccupied Heating Setpoint (67° F)
 - Unoccupied Cooling Setpoint (80° F)
 - Effective Heating Setpoint (Active)
 - Effective Cooling Setpoint (Active)
 - Supply Airflow Setpoint (Active)
 - Minimum Supply Airflow Setpoint (See VAV Schedule)
 - Maximum Supply Airflow Setpoint (See VAV Schedule)
 - Local Occupancy Override Time (1 Hour)
 - Local Setpoint adjustment Range (+/- 1° F)

> VAV BOX CONTROL DETAILS AND REQUIREMENTS

- The following analog (AI), binary (BI) inputs and binary output (BO) control points will be provided for each VAV box through the corresponding BAS controller: Space Temperature (AI), Supply Air Temperature (AI), Supply Airflow (AI), Damper Position (AI), Local Setpoint Adjustment (AI), Local Occupancy Override (BI), Damper Drive Open (BO), Damper Drive Closed (BO), Electric Heating Stage 1, 2, and 3 On/Off (BO)
- Access to the BAS will be accomplished through the BAS Operator workstation in the Building Engineering office. All control points and setpoints will be available for monitoring and/or adjustment, as permitted by the access level of the user, through a graphical user interface. A graphic will be provided for each VAV box with all setpoints and operating conditions, and for the corresponding floor plan with all VAV box locations and space conditions.

II. OCCUPIED MODE

- VAV box damper will be modulated to maintain the supply airflow setpoint. The supply airflow setpoint will be gradually reset between the corresponding minimum and maximum setpoints to maintain the space temperature at the occupied cooling setpoint.
- When the supply airflow setpoint is equal to the corresponding minimum setpoint, the VAV box electric heating coil will be cycled on and off in one to three stages (as scheduled) using proportional plus integral control to maintain the space temperature at the occupied heating setpoint.

III. UNOCCUPIED MODE

- When the associated air handling unit cycles off during the VAV box unoccupied mode, the VAV box damper will be signaled fully open. When the associated air handling unit cycles on during the VAV box unoccupied mode, the VAV box will be controlled as described for occupied mode except the unoccupied heating and cooling setpoints will be referenced.

IV. WARM-UP MODE

- When the associated air handling unit is started in warm-up mode, the VAV box will be controlled as described for occupied mode to raise the space temperature to the occupied heating setpoint before the occupied mode start time.

V. COOL-DOWN MODE

- When the associated air handling unit is started in cool-down mode, the VAV box will be controlled as described for occupied mode to lower the space temperature for the occupied cooling setpoint before the occupied mode start time.

VI. TRENDING

- Trend information will be recorded at the intervals desired for all setpoints and analog control points requested by the Owner. Trend info will be recorded initially at 15-minute intervals for the following setpoints and analog control points: Effective Heat Setpoint, Effective Cooling Setpoint, Space Temperature, Supply Air Temperature, Supply Airflow Temperature, Supply Airflow Setpoint, Supply Airflow, and Damper Position
- Trend info will be recorded upon a change of state for all binary control points requested by the Owner. Trend info will be recorded initially for the following binary control points: Electric Heating Stages 1, 2, and 3 On/Off
- Trend info will be uploaded to the BAS operator workstation as required to prevent the loss of any info.

VII. ALARMING

- Local alarms will be initiated and displayed at the BAS operator work station for the following conditions:
 - High Space Temp (85° F)
 - Low Space Temp (62 °F)
 - BAS Controller Offline
- Remote alarms will be sent via text message and/or email as requested by the Owner for the following minute alarms:
 - High Space Temp
 - Low Space Temp
 - BAS Controller Offline
- Alarms will be recognized after a 1-minute delay unless noted otherwise. A BAS controller offline alarm will be recognized after a 5-minute delay.
- Alarms will include the alarm description, setpoint and control point values (where applicable), date, and time.
- Alarms will be acknowledged and cleared at the BAS operator workstation, with a stored record of the corresponding user, date, and time.
- All alarm setpoints and time delays will be adjustable.

> STRUCTURAL > BUILDING DETAILS

Fashion District Philadelphia is a conglomeration of approximately a dozen structures primarily consisting of moment-resisting steel frame buildings. The floors are cast concrete on steel deck over steel beams. The steel is generally protected with sprayed fibrous “fireproofing” although some has concrete encasement. Copies of the original structural drawings are available for most of the complex.

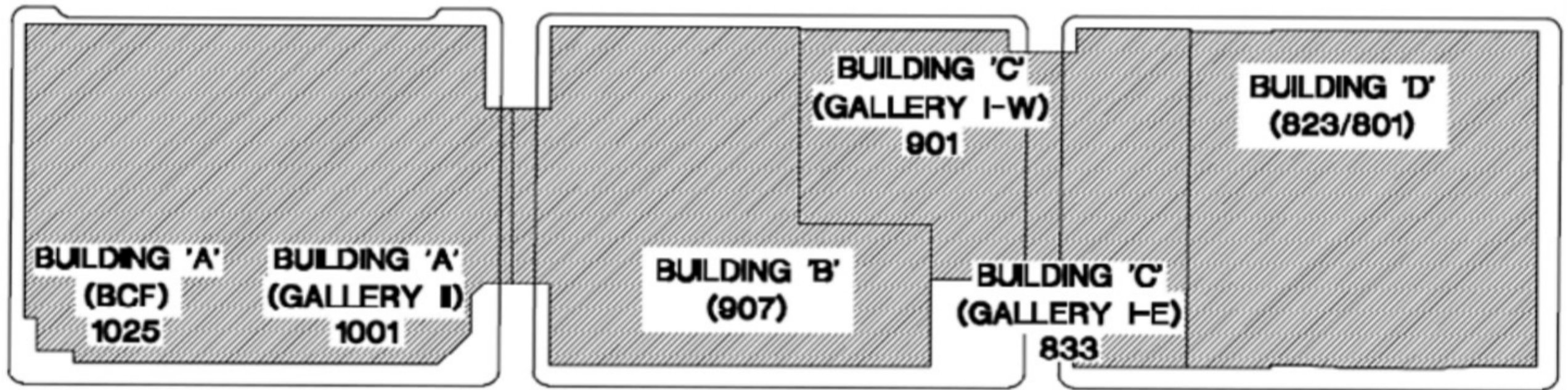

LOAD CAPACITIES

	Bldg. A West 1025 Market	Gallery II Bldg. A East 1001 Market	Bldg. B 907 Market	Gallery 1 West & East Bldg C 901 + 833 Market
roofs	30	30	30	30
5th	NA	80	80	NA
4th	NA	175	80	150
3rd	80	80	80	100
2nd	80	80	80	100
Street	100	100	100	100
Concourse	100	100	100	100

ADDITIONAL STRUCTURAL INFO

- The 4th floor of Gallery 1 and Gallery 2 are mechanical rooms intended to support overbuild structures
- Sidewalks were designed for 250 lbs psf
- Streets were designed for HS20-44 (highway)
- Transfer girders are used to span the drive aisle of the Truck Level

> DESIGN REQUIREMENTS

DESIGN REQUIREMENTS

- **SELF SUPPORTED STOREFRONTS** are required. Tenant may not support the storefront from the bulkhead or fascia. Structural lateral bracing support for Tenant storefronts must be from the roof joists.
- **ROOF DECK ATTACHMENT OR USE AS SUPPORT** for fixtures and equipment is not permitted.
- **HEAVY ITEMS** require structural drawings if weighing 300 lbs. or more.
- **JOIST REINFORCING** is required for roof top equipment as well as steel support for all roof openings.
- **UPPER LEVEL TENANT'S** must review base building structural drawings prior to installing a security safe, ovens or any equipment weighing 300 lbs. or more.
- **SLAB CORING IS NOT PERMITTED** in the Concourse level section highlighted below. This section is located over the SEPTA regional rail.

NO CORING ZONE - CONCOURSE LEVEL
CORING PROHIBITED DUE TO SEPTA RAIL BELOW



> SLAB DETAILS

STRUCTURAL DETAILS

The following diagrams show the coring and waterproofing criteria for the various slab conditions through the property.

CORING THROUGH (E) SLAB ON DECK

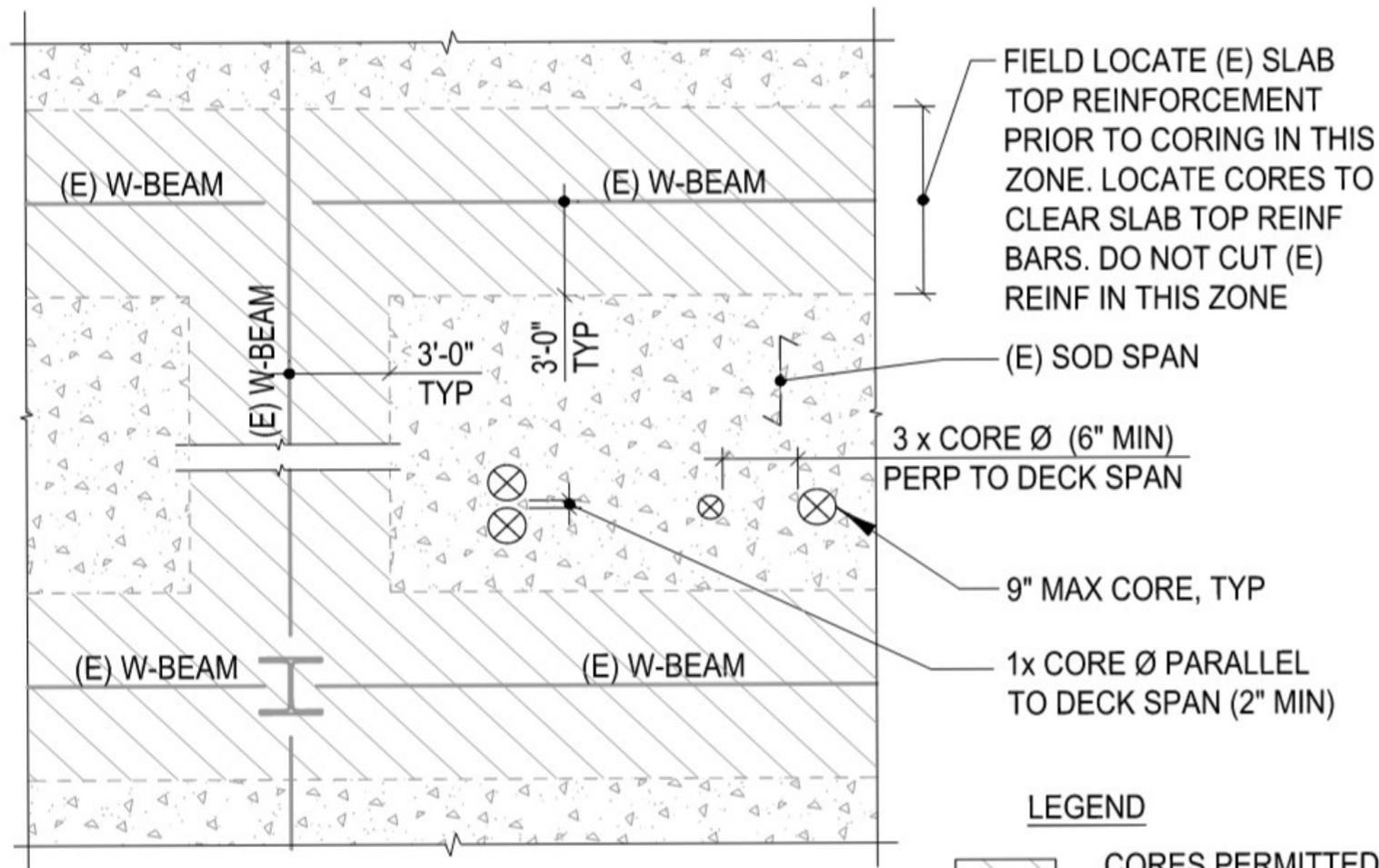

NOTES:

1. THESE LIMITATIONS APPLY TO BOTH NEW CORES & NEW CORES PLACED ADJACENT TO EXISTING CORES.
2. THE MINIMUM SPACING BETWEEN CORES MAY BE BASED ON THE SMALLER CORE DIAMETER.
3. WHERE THE ABOVE CRITERIA CAN NOT BE SATISFIED, PROVIDE ADDITIONAL STEEL FRAMING AROUND THE SLEEVE OR SLEEVE GROUP PER L/S4.02.

CORING THROUGH (E) PAN JOIST SLAB

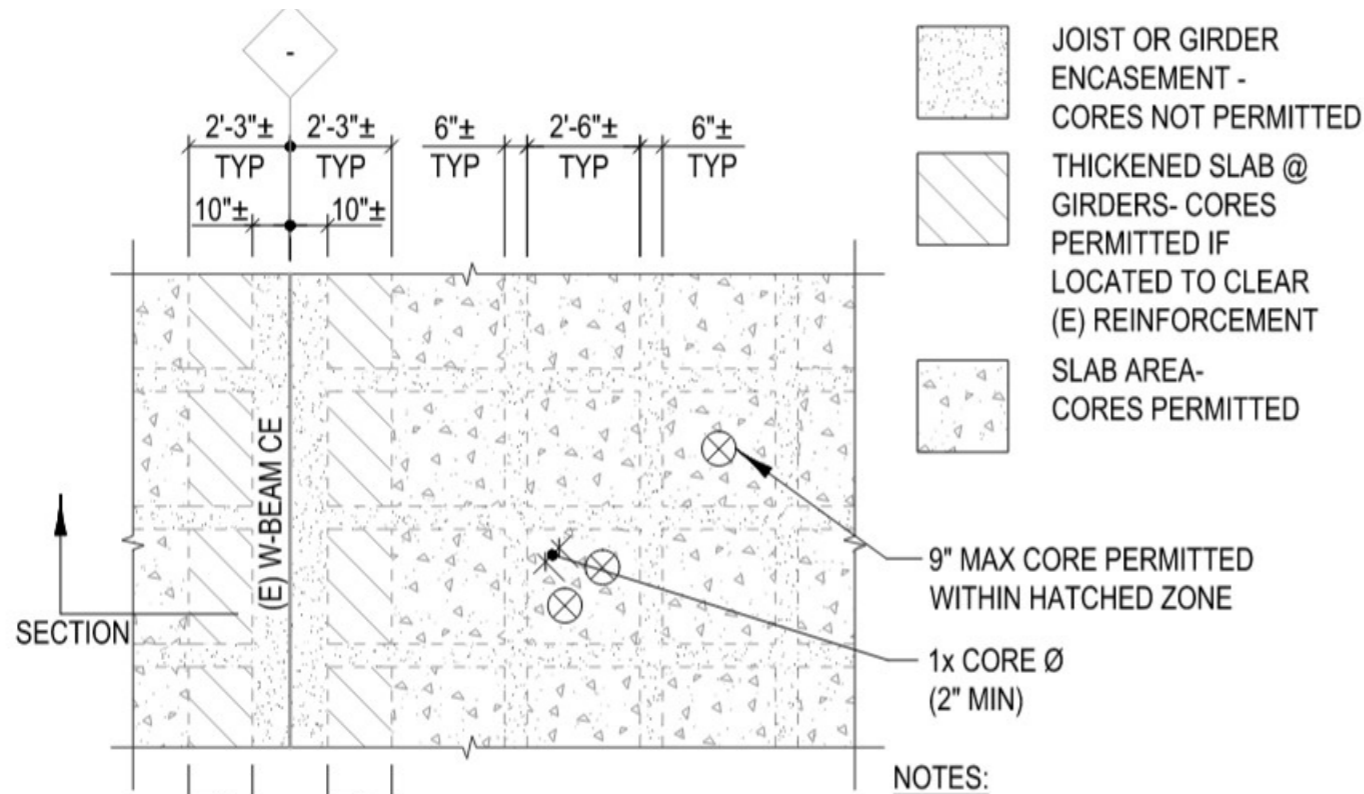

NOTES:

1. THESE LIMITATIONS APPLY TO BOTH NEW CORES & NEW CORES PLACED ADJACENT TO EXISTING CORES.
2. THE MINIMUM SPACING BETWEEN CORES MAY BE BASED ON THE SMALLER CORE DIAMETER.

FIELD LOCATE (E) TOP & BOT REINFORCEMENT PRIOR TO CORING IN THIS ZONE. DO NOT CUT (E) REINF IN THIS ZONE.

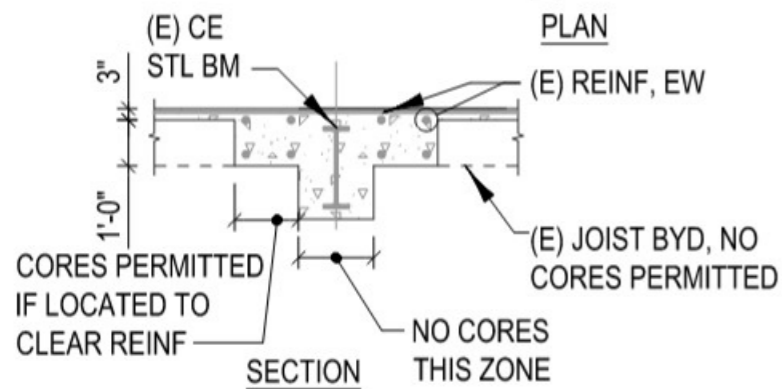

NEW OPG IN (E) SOD

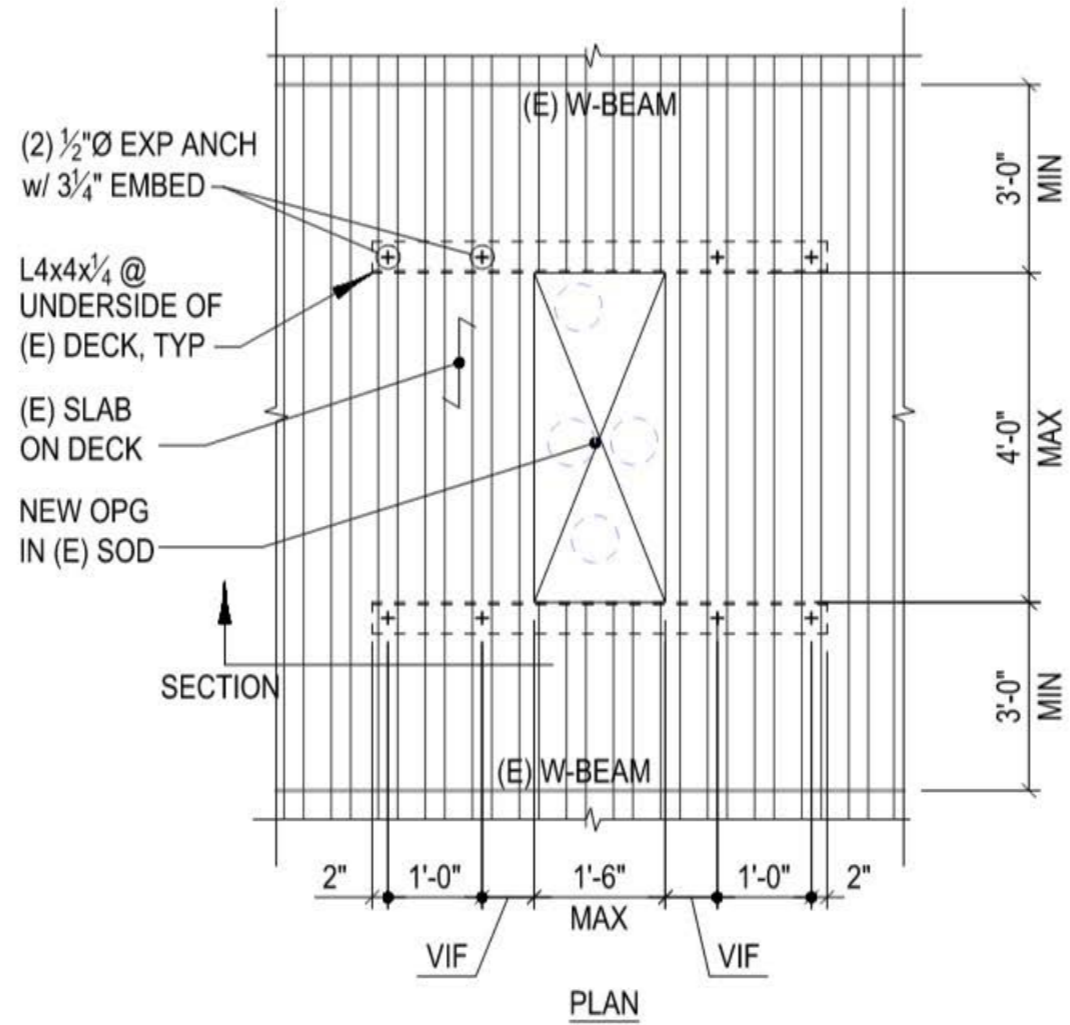
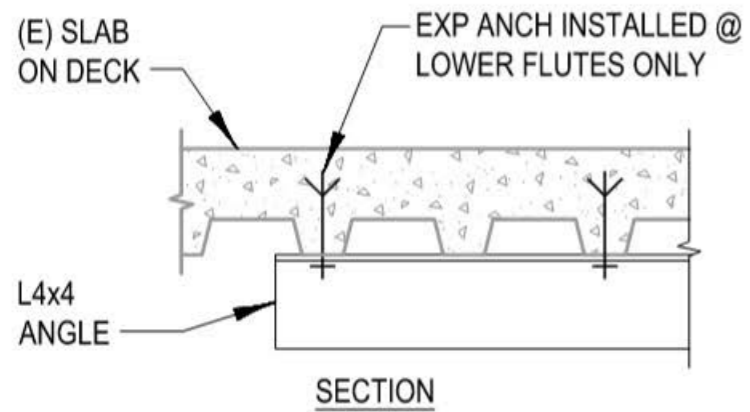

CORING THROUGH E SLAB

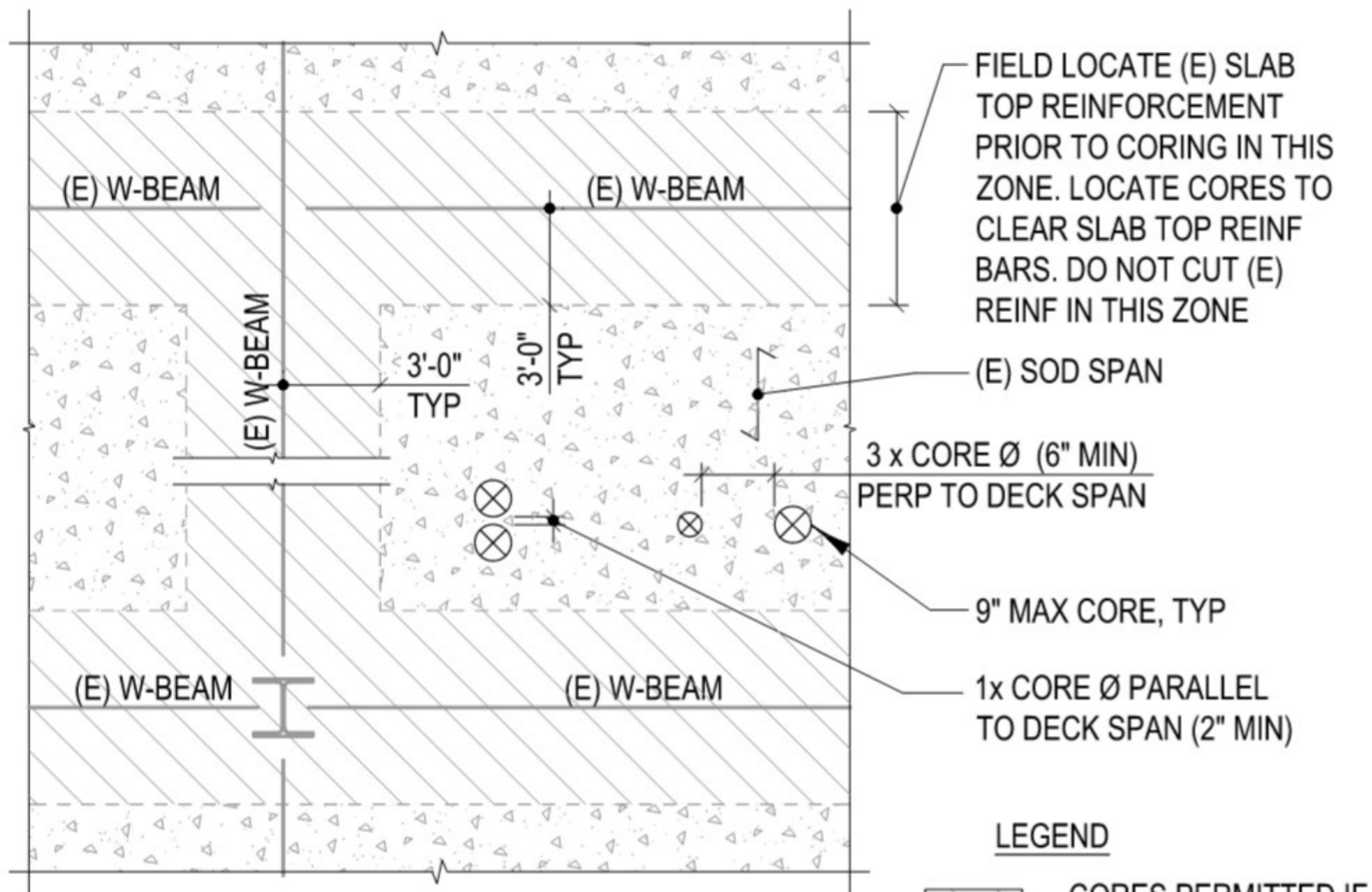

NOTES:

1. THESE LIMITATIONS APPLY TO BOTH NEW CORES & NEW CORES PLACED ADJACENT TO EXISTING CORES.
2. THE MINIMUM SPACING BETWEEN CORES MAY BE BASED ON THE SMALLER CORE DIAMETER.
3. WHERE THE ABOVE CRITERIA CAN NOT BE SATISFIED, PROVIDE ADDITIONAL STEEL FRAMING AROUND THE SLEEVE OR SLEEVE GROUP PER L/S4.02.

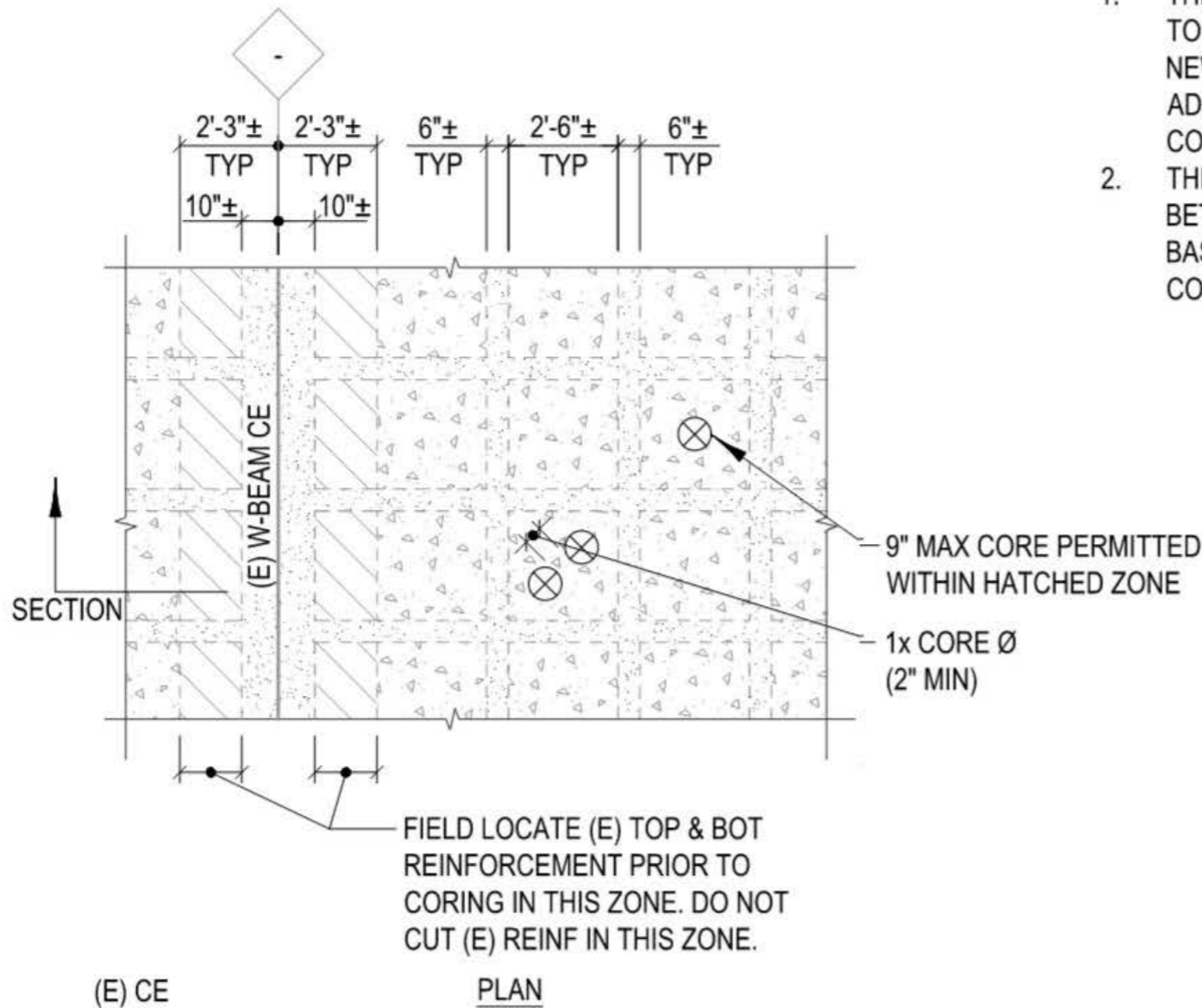

CORING THROUGH E PAN JOIST



NOTES:

1. THESE LIMITATIONS APPLY TO BOTH NEW CORES & NEW CORES PLACED ADJACENT TO EXISTING CORES.
2. THE MINIMUM SPACING BETWEEN CORES MAY BE BASED ON THE SMALLER CORE DIAMETER.

LEGEND

-  JOIST OR GIRDER ENCASEMENT - CORES NOT PERMITTED
-  THICKENED SLAB @ GIRDERS- CORES PERMITTED IF LOCATED TO CLEAR (E) REINFORCEMENT
-  SLAB AREA- CORES PERMITTED

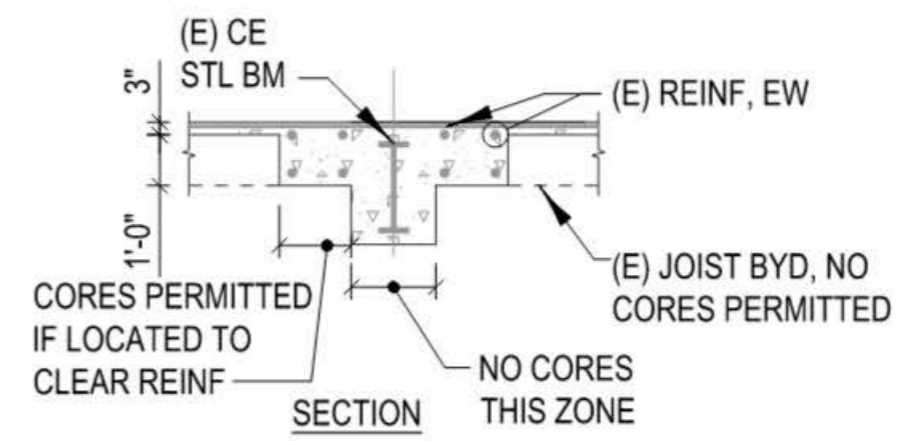

STREET LEVEL WATERPROOFING PLAN AND SECTION DETAILS - BLDG A

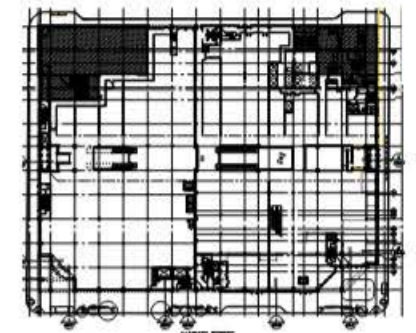
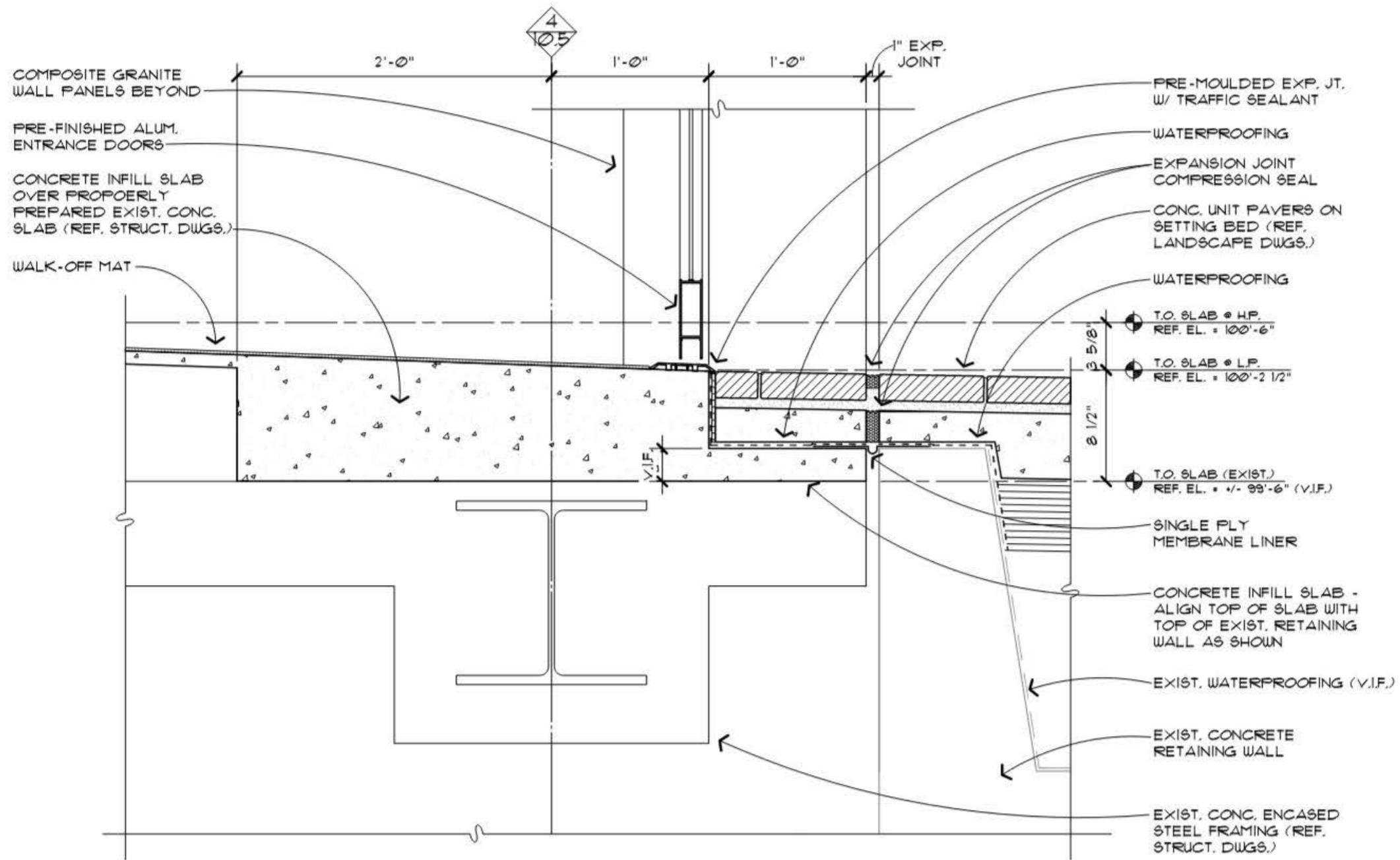

STREET LEVEL WATERPROOFING PLAN AND SECTION DETAILS - BLDG B

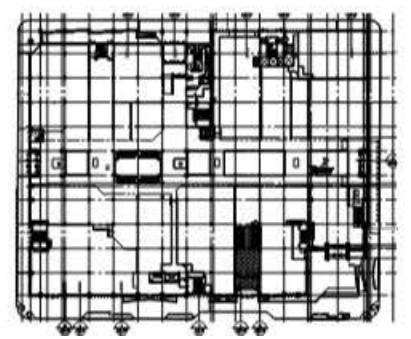
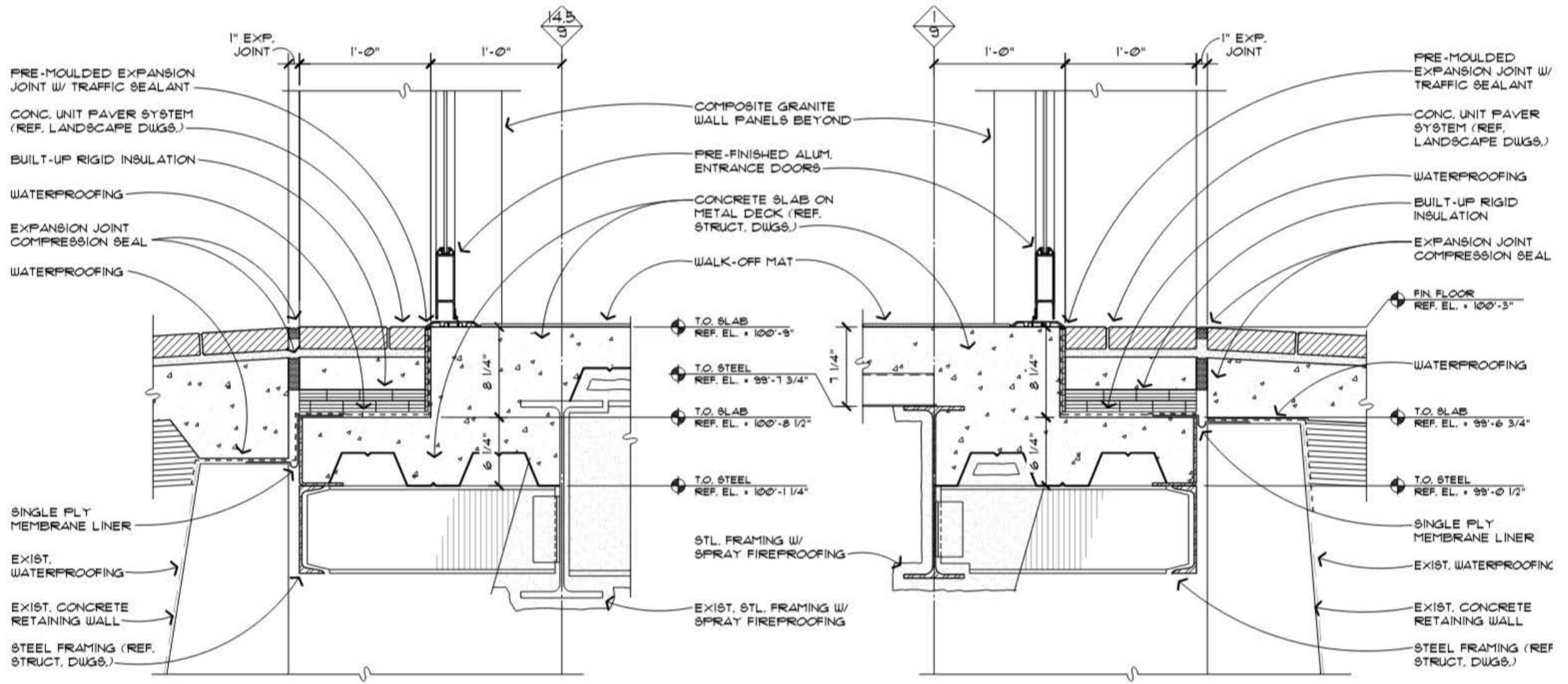

STREET LEVEL WATERPROOFING PLAN AND SECTION DETAILS - BLDG C

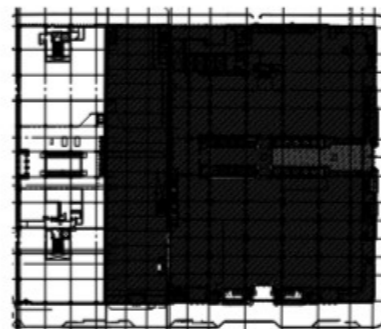
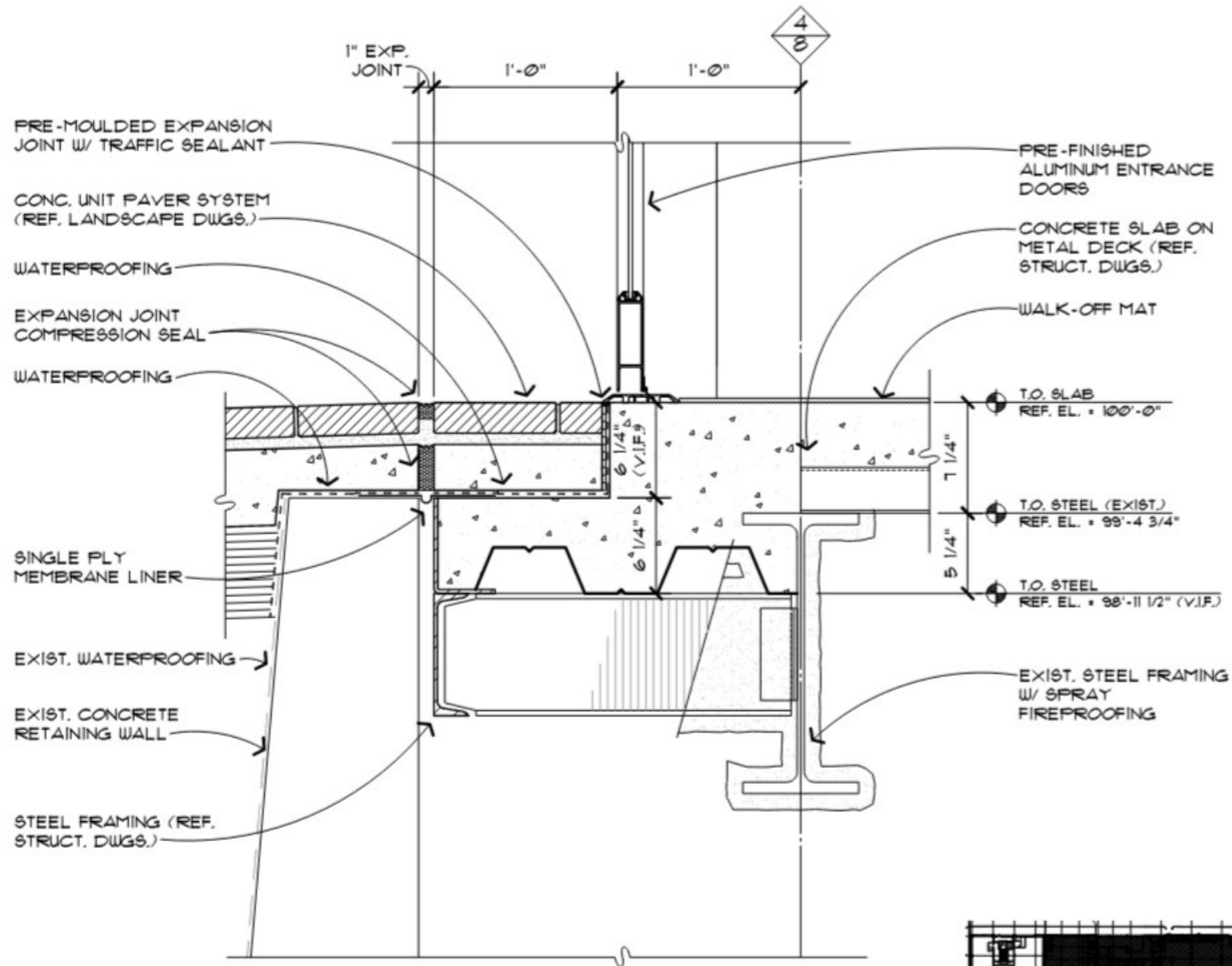

FOOD CRITERIA CONTENT OVERVIEW

2.1

FOOD HALL

DETAILS SPECIFIC DESIGN, SIGNAGE, AND TECHNICAL REQUIREMENTS FOR FOOD HALL TENANTS.

2.2

INLINE COUNTER SERVICE

DETAILS SPECIFIC DESIGN, SIGNAGE, AND TECHNICAL REQUIREMENTS FOR FOOD TENANTS WITH COMMON AREA FACING COUNTER SERVICE AND LIMITED TO NO SEATING.

2.3

RESTAURANTS

DETAILS SPECIFIC DESIGN, SIGNAGE, AND TECHNICAL REQUIREMENTS FOR FOOD TENANTS WITH INTERIOR OR EXTERIOR FACING RESTAURANT SERVICE.

SECTIONS OF INTEREST

INLINE CRITERIA

Standard design, technical, and sign requirements in addition to the contents in this section.

DESIGN INSPIRATION

Provides design inspirations for visual aesthetics.

BUILDING DETAILS

Includes property reference photos and specific Storefront design details.

PROPERTY INFO

Includes information on the Property's building codes, area permitting, and required contractors.

SUBMITTALS

Outlines requirements on how and what to compile for submittals to the Landlord for design reviews.

This Food Tenant Criteria is specifically tailored to highlight unique technical and design requirements for Tenant's cooking, preparing, and selling food products.

Through the application of the Criteria guidelines, Food Tenants will produce distinctly original designs unique to their brand and the Center. These guidelines are to help maintain a consistent design quality while still allowing each Tenant to achieve a high level of expression and diversity.

The goal is to enhance the shopping experience for our Customer through the quality and artfulness of Tenant design.

This Criteria will often point to the [INLINE RETAIL CRITERIA](#) as several requirements and design concepts are shared.

The Tenant's Architect is encouraged to contact the Landlord's Tenant Coordinator to discuss any specific design intentions prior to commencing design work. The Tenant Coordinator will strive to resolve all outstanding design issues. However, the Tenant Coordinator may, in the best interest of the Center, reject any aspect of the Tenant's design.

If an acceptable design cannot be agreed upon, the Landlord may, at the Tenant's expense, provide an additional concept Storefront design for consideration.



> CONTENTS

- FOOD HALL ZONE PLAN**
- DESIGN**
 - STOREFRONT*
 - FOOD DISPLAY & PREP / SEATING / QUEUING*
 - LAYOUT / SERVICE COUNTER DESIGN*
 - STOREFRONT & COUNTER MATERIALS / COUNTER ELEMENTS*
 - LIGHTING*
 - STOREFRONT CEILING / ROLLING GRILLE / NEUTRAL PIERS & DEMISING WALLS*
 - INTERIOR & PREP AREAS*
- SIGNAGE**
 - STOREFRONT*
 - MENU BOARD*
- TECHNICAL**

SECTIONS OF INTEREST

- DESIGN INSPIRATION**
Provides design inspirations for visual aesthetics.
- PROPERTY INFO**
Includes information on the Property's building codes, area permitting, and required contractors.
- SUBMITTALS**
Outlines requirements on how and what to compile for submittals to the Landlord for design reviews.

The Food Hall Criteria provides key technical information and design requirements to ensure your food service enlivens the consumer experience and interfaces with the Center's food court design.

The Tenant and the Tenant's architect assume the following important obligations:

- Fulfill the intent of the Criteria both in concept and in detail.
- Determine and respond to the actual physical conditions of the Tenant's location.
- Maintain and enhance the high standards of quality established in the construction of the Center.
- Ensure the quality of execution of all design material, finish, and detail concepts in the construction of the Tenant's improvement.
- Provide the required detail at all transitions from Tenant Storefront to neighboring Storefronts, as well as to the base building.



> ZONE PLAN

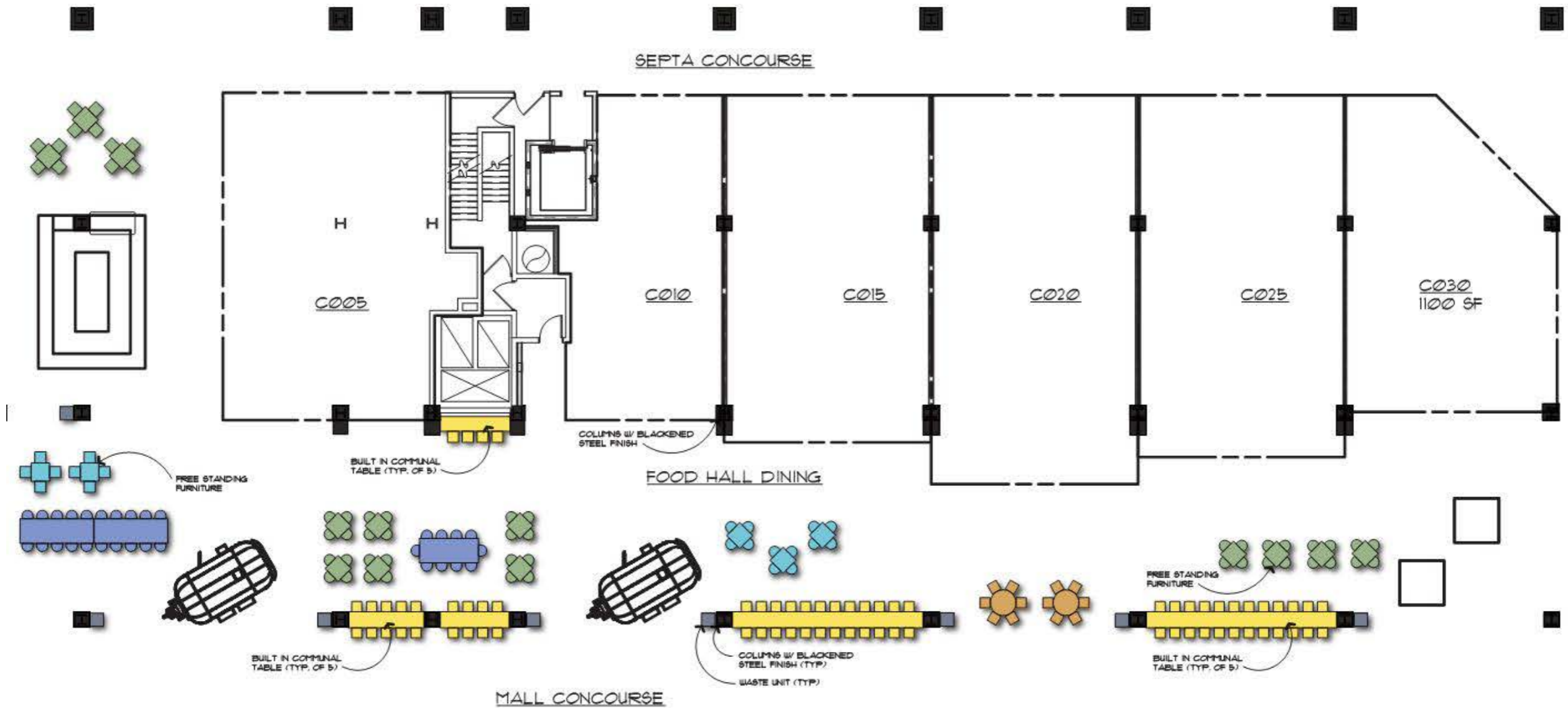

- FDP's Food Hall layout allows for each in-line space to incorporate two storefronts - one facing the mall interior, and the other facing the SEPTA train station to maximize customer flow and enticement.
- Spaces C015, C020, and C025 also include seating bump outs, allowing for unique patio style storefront designs.
- FDP also provides common seating as shown by the colored seating shown above.

> ZONE DETAILS

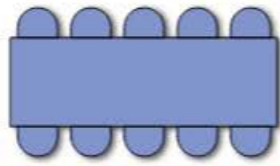

SEATING GROUP 1



SEATING GROUP 2



SEATING GROUP 3

CHR-01

MANUF.: TOLIX
 STYLE: MARAIS A56 ARM CHAIR
 FINISH: BLACK



STL-01

MANUF.: TOLIX
 STYLE: MARAIS COUNTER STOOL
 FINISH: BLACK



CHR-02

MANUF.: INDUSTRY WEST
 STYLE: SCOOP CHAIR
 FINISH: BLACK METAL



TBL-01 & TBL-02

MANUF.: TRUEFORM CONCRETE
 STYLE: ZEN CONCRETE DINING TABLE
 BRUSHED STAINLESS STEEL
 FINISH: TOP - PEWTER
 BASE - INDUSTRIAL PATINA



TBL-03

TABLE TOP
 MANUF.: TRUEFORM CONCRETE
 STYLE: CONCRETE DINING TOP
 FINISH: CONCRETE

TABLE BASE
 MANUF.: HARMONY CONTRACT FURNITURE
 STYLE: ANTHEM BASE W/ FOOT RING
 FINISH: SATIN BLACK



TBL-04

TABLE TOP
 MANUF.: TRUEFORM CONCRETE
 STYLE: CONCRETE DINING TOP
 FINISH: CONCRETE

TABLE BASE
 MANUF.: HARMONY CONTRACT FURNITURE
 STYLE: ANTHEM BASE
 FINISH: SATIN BLACK



> ZONE DETAILS

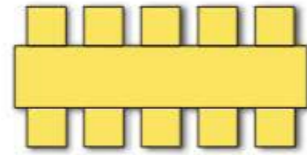

SEATING
GROUP 4

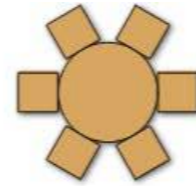

SEATING
GROUP 5



MISC.
GROUP 6

STL-02

MANUF.: INDUSTRY WEST
STYLE: HAUTEVILLE
BAR STOOL
FINISH: CONCRETE & METAL



CHR-01

MANUF.: TOLIX
STYLE: MARAIS A56 ARM CHAIR
FINISH: BLACK



TSH-01

MANUF.: ID METALCO
STYLE: YES LITTER BIN
FINISH: TBD
GRAPHICS: TBD



BUILT-IN COUNTERTOP

MANUF.: STONE SOURCE
STYLE: GIOIA VENATINO
WHITE MARBLE SLAB
FINISH: HONED



TBL-05

MANUF.: TRUEFORM CONCRETE
STYLE: TORRE ROUND CONCRETE
DINING TABLE
FINISH: TOP - CONCRETE
BASE - INDUSTRIAL PATINA



> ZONE DETAILS



DA

(EXISTING PENDANTS ALREADY PURCHASED, VERIFY QUANTITY - PURCHASE NEW AS REQUIRED TO MATCH EXISTING)
 LOCATION: ABOVE BUILT IN DINING LEDGES
 MFR: LBL LIGHTING
 STYLE: LOFT GRANDE
 COLOR: RUBBERIZED BLACK W/ POLISHED NICKEL CAGE
 MOUNTING HEIGHT: 6'-6" AFF TO UNDERSIDE OF FIXTURE (VERIFY)

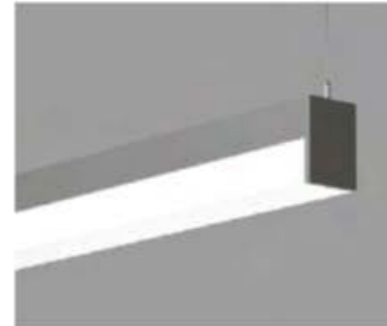

FF-01

(EXISTING LINEAR SUSPENSION ALREADY PURCHASED. VERIFY QUANTITY - PURCHASE NEW AS REQUIRED TO MATCH EXISTING)
 LOCATION: DINING AREA
 MFR: LUMENWERX
 COLLECTION: QUAD DIRECT
 STYLE: NARROW PENDANT
 COLOR: SATIN NICKEL
 SIZE: 72"L X 2.5"D X 3.5"H
 LAMP: LED
 MOUNTING HEIGHT: VARIES



DB

(SCONCE)
 LOCATION: AT COLUMNS
 MFR: EUREKA LIGHTING
 STYLE: EQUINOX 3412 SQUARE
 MODEL #: 3412-2XLED.1-3500K-NARROW
 COLOR: ANTHRACITE FINE TEXTURE
 MOUNTING HEIGHT: CENTERED ALONG INSIDE OF FINISHED COLUMNS BETWEEN MALL CONCOURSE & DINING AREA (9 TOTAL)

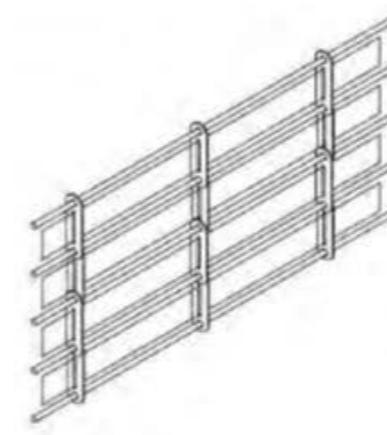

SECURITY GATE

LOCATION: AT ALL TENANT SECURITY ENCLOSURES
 MFR: OVERHEAD DOOR CORPORATION
 MODEL: SERIES 670 MILL ALUM.
 STYLE: STRAIGHT LATTICE PATTERN; MOTORIZED
 COLOR: ALUMINUM, MILL FINISH
 MOUNTING: LANDLORD PROVIDED SOFFIT

*NOTE: ALL TENANT GATES TO MATCH EXISTING GATE AT TIFFANY'S SPACE. TENANTS TO PROVIDE ALL SECURITY GATES AS NEEDED TO SECURE THEIR SPACE PER LL SPEC.

> DESIGN > STOREFRONT

OVERVIEW

FDP's Food Hall includes a variety of spaces that are comfortable and stylish, inviting the Customer to come, stay, eat, and enjoy.

The design of each unit, as viewed from the common area, must convey the unique character and sense of identity for each Tenant and also be compatible with the overall Architectural design of the Food Hall.

The Storefront design area considers all portions of the store that are visible to the public, in front of the full height service area partition.

Unique and unexpected storefront design will spark interest for to draw in Customers.

Encouraged storefront design traits include:

- Use of contrast:
 - Mixing modern and traditional design elements.
 - Mixing neutrals with colors.
 - Blending shiny and matte surfaces.
- Combining patterns with solids.
- Embracing unique craft and technology.
- Using special features, tasteful props, and displays.



> FOOD DISPLAY & PREPARATION / SEATING / QUEUING

FOOD DISPLAY

Showcases must reinforce the Tenant's image and be an integral part of the design within the counter.

Glass must be tempered or a safety type. Plexiglas is not permitted.

Showcases shall not exceed 14" above counter and 36" overall width. It shall not be more than 50% of the counter length and located no closer than 48" from the neutral pier.

FOOD PREPARATION AS THEATRE

When food preparation is visible to the public, the area is required to be designed with a sense of theater.

The need for an authentic, shared, and unique experience has grown over time. Unique experiences are the opposite of one-size-fits-all approach of the "chain". Tenants that offer a peek into the making of what they sell help include the customer and make for an authentic experience.

SEATING

- Tenants seating should be designed to compliment the common area seating as detailed in the [ZONE PLAN](#).

QUEUE AREAS

- All food venues must provide a queue layout that allows for the mall circulation to maintain its code minimum distances for general circulation.
- Stanchions are not allowed. Other indicator for Customer directional flow will be considered.



> LAYOUT / SERVICE COUNTER DESIGN

LAYOUT

Due to the high visibility of the Customer Service Area, particular attention is given to the design review of this area. Service areas, furnishings, display cookery, food prep and cooking areas visible from the mall common area must meet strict design standards.

- Support rooms and storage shall be concealed from public view.
- A full-height partition wall must separate the Customer Service Area and Prep Area.
- Access to the Prep Area shall be via a self-closing door or between staggered “blind walls”.
- Pass-thru windows with any customer views into kitchen zone are not allowed.
- Landlord may require that any storefront setback area shall have flooring compatible in quality, color and pattern to the mall flooring material.
- All Tenant construction shall be self-supporting from the floor and structurally independent of the mall fascia and bulkhead structure. Tenant Construction may be braced horizontally/laterally to the overhead structure (not to the roof deck) within the Tenant space as depicted on Tenant plans and approved by the Landlord.

FRONT SERVICE COUNTER DESIGN

- The vertical counter face cannot be on one plane. Design must include areas that pop in and pop out to create movement. This can be achieved by recessing a small portion of the counter face by a few inches or can be more dramatic. This can also be achieved by ranging counter heights and taller vertical elements. Taller vertical elements must not block visibility.
- Counter face cannot be all one material. Must incorporate a minimum of two to three different types of material that coordinate well together.
- Vertical elements can include a plasma screen menu board or can have additional vertical signage.
- Tenant to specify a protective edge at the bottom of the counter.
- The form and materials used for counters shall be designed to be inviting to the public to help lure them to the space.
- The toe kick material must be a minimum of 3” behind the face of the counter.
- All Tenant build out must be contained within the lease line unless specifically noted in this criteria.
- Counter tops must be “Corian” or similar solid surface materials, metal or stone. Tenant counter and counter tops are to be custom designed and fabricated. Plastic laminate is prohibited.
- Plastic laminated countertops are prohibited.
- Maximum counter height is 3’-6”. Counter design, including heights, must comply with all accessibility guidelines enforced by national or local jurisdictions and the Americans with Disabilities Act.
- Sneeze guards shall be used above the front counters as required.

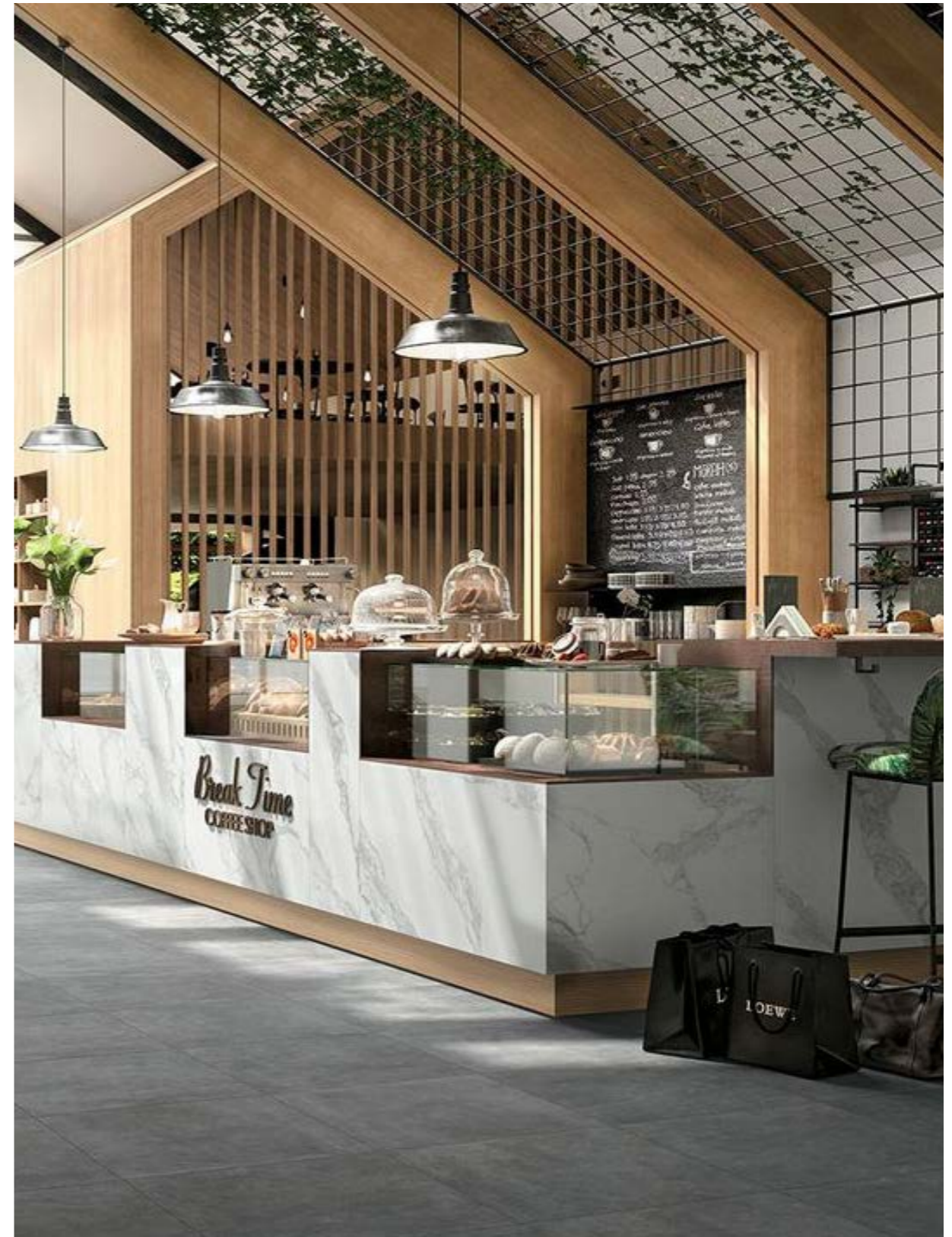

> STOREFRONT & COUNTER MATERIALS / COUNTER ELEMENTS

FRONT SERVICE COUNTER AND STOREFRONT MATERIALS

- All finish materials must be backed by a minimum 5/8" solid surface material and may include the following:
- Counter tops must be solid surface materials, metal or stone. Tenant counter and counter tops are to be custom designed and fabricated.
- All stone/tile colors must be integral throughout.
- Metal panels and architectural hardware shall have a professional and durable finish.
- Color anodized, baked painted or antique finish.
- Wood veneers and weathered or distressed wood (submit specification for approval)
- Resin panels such as 3-Form products
- Back-painted tempered glass panels
- Glass tiles

Finish materials shall NOT include the following materials:

- 4"x4", 6"x6", 12"x12" glazed tiles
- Shingles or boards
- Plastic laminate
- Faux or plastic formed brick, block or stone
- Clear anodized aluminum
- Other materials as deemed unacceptable by Landlord

COUNTERTOP ELEMENTS

- Cash registers must be recessed so that they extend no more than 9" above the counter top.
- Condiment and utensil displays or dispensers must be fully recessed into the counter.
- Fully-recessed counter-top trash receptacles (for straw wrappers, etc.) must be provided near the condiment and utensil displays.
- Tray rails, if used shall be integrated into the counter design, be contained within the lease line.
- Drink dispenser and other utilitarian kitchen equipment may not be placed on the front counter.



> LIGHTING

LIGHTING

Tenants must light both their Storefront as well as the countertop.

Lighting on architectural elements and menu boards are also required.

- Tenant is responsible for all lighting within the entire demised premises.
- Foot-candle levels at counter height shall be 50 FC average maintained.
- The use of decorative lighting such as luminous ceilings, chandeliers, pendant, wall units or clear type glitter strips are permitted if the location is approved by Landlord.
- No lighting shall be installed outside the demised premises.
- All Tenant lighting shall be controlled separately, and illuminated during mall hours.
- If incandescent quartz halogen lighting is used, Tenant shall provide specifications with submittal.
- To retain and protect the visual environment of the area and for the benefit of all Tenants, each individual Tenant shall limit the brightness of their lighting fixtures, which shall be subject to the Tenant Coordinator's approval.
- Emergency lighting must be fully recessed in the front-of house, (sales) areas. No surface mount type is allowed.
- No track lighting is permitted in the front of house area unless specifically approved by Landlord. It can be used if it is hidden or recessed into ceiling, otherwise Tenant should use mono-point type fixtures.
- Use of high quality fixtures is required. Submit cut sheets of fixtures including manufacturer, model and any photos of specific fixture to Landlord for design approval.
- Use staggered under counter lighting for an even distribution of light.
- Vertical storefront surfaces must be lit.
- Bottom of pendant light to be at 6'-8" minimum, a.f.f. installed

Recommended lighting approaches include but are not limited to:

- Pendant fixtures that are suspended by cord, cables or chain with uplight and/or downlight components.
- Recessed downlights
- Surface mounted high-tech, high quality, low profile and decorative fixtures
- Indirect ceiling cove lighting system using linear incandescent lamps, neon or florescent lamps.

Unacceptable lighting approaches include but are not limited to:

- H.I.D. lighting unless approved by the Architect and the shielding is specified in submittal.
- Direct visual exposure of incandescent lamps and/or fluorescent tubes.
- Acrylic or plastic lensed fixtures, or bare lamps
- Fluorescent fixtures
- Track light fixtures
- Strobe moving or fiber optic lights
- Floor-mounted fixtures

To create a consistent theme of lighting and appetizing color, lamp or "bulb" requirements must be adhered to as follows:

- No linear T-5, T-8 or T-12 fluorescent lamps are allowed, unless specifically installed in a ceiling cove where the lamp is not visible.



> STOREFRONT CEILING / GRILLE / NEUTRAL PIERS & WALLS

STOREFRONT CEILING

- Suspended ceiling of gypsum board, (hard lid), is required in customer areas.
- Tenant must provide a reflected ceiling plan indicating any and all Tenant lighting, suspended design elements and signage for Landlord approval.
- Ceiling access panels, where required must be depicted on the Tenant's plans, approved by Landlord and be provided at Tenant's expense.
- Allow for access to all structural mechanical, plumbing, electrical, telephone and fire protection systems including all junction boxes, switches, valves, etc. and other equipment for purposes of servicing, and maintaining this infrastructure.

ROLLING GRILLES

Rolling grilles are permitted and should be designed to match the aesthetic of neighboring Food Hall Tenants.

NEUTRAL PIERS AND DEMISING WALLS

The Customer Service Area shall address the full opening width, abutting the Neutral Walls and Neutral Knee Walls on each side of the leased space and extending full height to the Mall soffit.

- Mall structural columns, excluding those treated as neutral piers, located either within the Storefront Zone or along the store frontage, must be integrated into the store design unless otherwise directed by Landlord.
- Special condition neutral walls may be low and extend back from the face of the lease line. This condition increases visibility into the store, however, it requires close coordination with the Tenant Coordinator in the design process.



> INTERIOR AND PREP AREA

Kitchen areas, storage, dish areas, and any other areas not visible to the public must meet the following design requirements:

LIGHTING

Lighting may include, but is not limited to:

- 2'x4' lay-in surface-mounted fluorescent light fixtures.
- Any fixture allowed by code necessary for food preparation.

FLOORING

The entire Lease Premises shall be completely and properly sealed using a 'Dex-o-tex' NEOBOND II Fracture Resistant Membrane Waterproofing or equal membrane type sealer approved by Landlord, prior to the installation of any finished flooring material.

The membrane must be turned up all perimeter storefront walls, counters and surfaces a minimum of 24", to protect the adjacent Tenants and Mall common areas. Then, either FRP (prep area only), or tile is to be installed up to at least 4'.

Tenant to submit detail to Landlord for approval prior to installation.

Tenant shall furnish and install floor tile over waterproof membrane throughout the entire premises.

The finished floor must be sloped to the Tenant installed floor drains.

Allowed flooring materials include:

- Quarry tile
- Porcelain ceramic tile

Prohibited flooring materials include:

- Vinyl
- Glazed ceramic tile
- Carpet
- Any other material deemed unsuitable by the Landlord

CEILING

2'x4' drop-in panels with an approved finish shall be permitted in storage areas so long as they are not visible to the customers.

WALLS

All walls in the Prep Area must be of a durable, non-porous, washable surface as required by health codes.

EXIT DOORS

All exit door specifications, hardware, door handles, recess dimensions, etc. shall be per Landlord criteria and conform to local codes and ordinances.



> SIGNAGE > STOREFRONT

Food Hall Tenant's primary storefront sign must be creative, imaginative and incorporated into the overall storefront design.

DESIGN REQUIREMENTS

Design requirements include:

- Sign must be proportional to overall elevation. Landlord will review sign size on an individual basis. Sign length must not be more than 1/3 of the overall storefront length.
- Sign must complement overall design and add visual interest.
- Power must be concealed.
- 12" max letter height will be enforced.
- Back of sign must be finished.
- Tenant's storefront sign shall use reverse channel letters fabricated of painted stainless steel or aluminum, without exposed mechanical fasteners or fabricator identification tags.
- Signs shall not utilize prefabricated edging materials such as "Jewelite" and sintra (expanded PVC).
- Return edges on channel letters must be a minimum of 1-1/2" and a maximum of 4". All channel letters are to be stem mounted 2" of the sign board. Illumination to each letter should be 3500K warm white neon.
- All stems are to be finished to match adjacent surface sign board.
- All wiring, shields, and insulators, are to be hidden on the front and the sides by the sign board. All transformers are to be remotely located and may not be visible to the public. Signs are to be wired to the Tenant's panels, by Tenant.
- Tenant signs graphics will be limited to trade name and nationally recognized logo only. No so-called "tag-lines" will be allowed on Tenant's sign. The graphic may be of any font style. All graphics must be centered on the sign board. Tenant sign graphics may not extend outside of the designated sign area.
- Only one sign per Tenant is allowed.

PROHIBITED ELEMENTS

The following types of signs, sign components and devices shall not be permitted:

- Any sign, advertisement, notice stickers, decals or lettering other than the Tenant's name or graphic logo exhibited, inscribed, painted or affixed on any part of the storefront counter.
- Cloth, Styrofoam, cardboard, or paper signs.
- Handwritten signs except chalkboards used as menu boards.
- Visual or audio animated signs.
- Exposed neon crossovers or raceways.

CONSTRUCTION REQUIREMENTS

Construction/Installation requirements include:

- The Tenant is responsible for all signs, permits, power sources, connections and installations.
- All raceways, transformers, ballasts, PK housing, conduit boxes, electrode boxes and other wiring shall be concealed from public view.
- Exposed crossovers between letters or words are not permitted.
- Metal sign materials, fastenings and clips of all types shall be hot-dipped galvanized iron, stainless steel or brass. Black iron materials of any type are not permitted.
- Labels on exposed sign surfaces are not permitted except those required by local ordinances. Any required labels must be inconspicuous.
- All electrical sign components must be U.L. labeled.



> MENU BOARDS

Menu board applications must be a part of the overall store design. We strongly encourage using a graphic designer to create your boards.

DESIGN REQUIREMENTS

The following requirements must be when designing your menu boards:

- All menu boards must be submitted to the Landlord for review and approval prior to start of Tenant construction.
- Professional quality drawings/renderings must be submitted for approval.
- Design shall be an integral part of the graphics and complimentary to primary signage character.
- Overall width of menu board cannot exceed 60% of overall storefront width.
- Mounting height to be a minimum of 7'-0" to bottom of sign with maximum height of 10'-0" and held a minimum of 10" from edge of walls.
- The menu board must be non-reflective to avoid glare.

PERMITTED ELEMENTS

Permitted menu board design elements include:

- Artisan type quality such as chalkboards, painted wood or unusual materials and combinations of material.
- Frames, holders, text, photo displays, lighting and materials must be creatively designed.
- High quality digital print outs for menu board may be approved at Landlord's discretion.
 - Photographs used in menu boards must be professionally produced and approved by the Landlord.
- Externally illuminated menu boards are allowed.
 - Tenant is required to submit light fixture cut sheet for approval.

PROHIBITED ELEMENTS

Not permitted menu board design elements include:

- Standard factory designs.
- Standard surface-mounted box-type internally illuminated menu boards are not permitted.



> TECHNICAL

Food Court Tenants must adhere to the technical requirements found in the [INLINE TECHNICAL CRITERIA](#).

In addition to the requirements detailed in the Technical Criteria, Tenants cooking food in their space must adhere to the following:

GENERAL REQUIREMENTS

- **KITCHEN SINKS** including pot sinks, scullery sinks, pre-wash sinks and other kitchen units must be connected to a grease trap.
- **DISHWASHERS** may not be connected to grease trap.
- **OIL COLLECTION AND HAULING SYSTEM** is required for Tenants with fryers or other grease/oil generating equipment that does not run through an interceptor. Landlord may provide a centralized collection point. Coordinate with your Tenant Coordinator.
- **BACKFLOW PREVENTERS** are required for food service, hair salons or other Tenants with equipment or operations that have the possibility of backflow. These must be certified and acceptable to the water district and checked yearly or as required by the local authority having jurisdiction.

KITCHEN EXHAUST REQUIREMENTS

- **LANDLORD REVIEW** is required to ensure the exhaust does not compromise the ventilation air of adjacent mall roof top units.
- **GREASE EXHAUST** must tie into the Landlord provided Interceptor system located in the Truck Dock.

FUMES AND ODORS

The following constitutes the minimum requirements for special exhaust systems which Tenant must furnish and install in the Leased Premises for the elimination of fumes and odors due to Tenant operations:

- A total negative pressure of ten percent (10%) must be maintained during all hours that Tenant is operating its business in the Leased Premises.
- The HVAC system must be modified to provide additional make-up supply air to offset the quantity of air exhausted.
- The Tenant must have a certified air balancing contractor test the completed system and verify its operation according to these specifications. A copy of the air balancing report must be submitted to the Mall General Manager for review and approval prior to opening for business.
- The combined HVAC and exhaust system per the above-noted specifications must be in operation during all hours that Tenant is operating its business in the Leased Premises.
- The combined HVAC system must be connected to the Landlord EMS by the Landlord required contractor. See the Technical Criteria section for specifics.
- Indoor tenants which will be using any type of gas, liquid or solid fuel for heating, cooking or other use, must have an active carbon monoxide detector installed. The type should be and Hardwire Interconnectable 120- Volt Carbon Monoxide Alarm with Digital Display and Battery Backup.
- Carbon dioxide detection is required if tenant has a carbon dioxide systems with 100 lbs. or more of carbon dioxide used in their beverage dispensing applications.

STRUCTURAL

The structure or sub-structure that supports any new or replacement HVAC unit, transformer, other heavy equipment or modification of any structure or substructure, shall be designed, engineered and installed at Tenant's sole cost and expense.

Tenant shall provide structural engineering calculations and drawings from a licensed structural engineer (Registered in the State of the Center where the work is located) to Landlord for review and approval prior to installation of any such items or equipment.

All equipment is to be installed over structural members that can support the weight of the equipment in areas designated by Landlord.

All recommendations of design and verification of completion shall include the structural engineer's embossed seal from the state.

ELECTRICAL

An empty, separate meter socket will be stubbed to the Tenant premises from the Mall electrical room. Tenant must install a demand check meter per Landlord specs using the Landlord required contractor. See the Technical Criteria section for specifics.

MECHANICAL

Tenants must furnish and install their own mechanical systems as required for their operation.

NATURAL GAS

Natural gas service is available for Tenants to obtain from the local gas company. Gas is permitted for cooking equipment only. Gas is not available for HVAC.

POTABLE WATER

A single water stub-in will be supplied by the Landlord from the Landlord's meter to each Tenant space. Tenant shall provide a water sub-meter that is accessible to Mall management.

SANITARY WASTE

A 4" sanitary waste line shall be stubbed below each Tenant space by Landlord. Tenant shall route their own vent lines to a point above the roof.

GREASE WASTE

Tenant must provide their own grease interceptors, within the demised premises.

FIRE PROTECTION / SPRINKLER SYSTEM

Tenants must use the Mall's required sprinkler contractor as well as connect to the Landlord's fire alarm system, using the Landlord required fire alarm contractor.

INLINE COUNTER SERVICE > CONTENTS

❑ DESIGN

- ❑ *PREP & FOOD DISPLAY / LAYOUT*
- ❑ *QUEUE / PATIOS / SEATING*
- ❑ *COUNTER DESIGN / COUNTER ELEMENTS*
- ❑ *MATERIALS / LIGHTING / FLOORING*

❑ SIGNAGE

- ❑ *PRIMARY SIGNAGE / MENU BOARDS*

❑ TECHNICAL

SECTIONS OF INTEREST

❑ *INLINE CRITERIA*

Includes standard design, technical, and sign requirements in addition to the contents in this section.

❑ *DESIGN INSPIRATION*

Provides design inspirations for visual aesthetics.

❑ *BUILDING DETAILS*

Includes property reference photos and specific storefront design details.

❑ *PROPERTY INFO*

Includes information on the Property's building codes, area permitting, and required contractors.

❑ *SUBMITTALS*

Outlines requirements on how and what to compile for submittals to the Landlord for design reviews.

The Inline Food Counter Service Criteria provides key technical information and design requirements to ensure your common area facing counter food service enlivens the consumer experience and interfaces with the Center.

This criteria will often point to the [INLINE RETAIL CRITERIA](#) as several requirements and design concepts are shared. The content in this section highlights the unique concepts for food service design.

The Tenant and the Tenant's architect assume the following important obligations:

- Fulfill the intent of the criteria both in concept and in detail.
- Determine and respond to the actual physical conditions of the Tenant's location.
- Maintain and enhance the high standards of quality established in the construction of the center.
- Ensure the quality of execution of all design material, finish, and detail concepts in the construction of the Tenant's improvement.
- Provide the required detail at all transitions from Tenant storefront to neighboring storefronts, as well as to the base building.



> DESIGN > PREP & FOOD DISPLAY / LAYOUT

Inline and Restaurant Food Tenants must adhere to the design requirements found in the [INLINE RETAIL DESIGN CRITERIA](#).

In addition to the requirements detailed in the Design Criteria, Tenants serving food in their space must adhere to the following design requirements:

PREPARATION AS THEATER

Tenant's offering a peek into the making of food, by nature, include the customer and make for an authentic experience. This inclusion of the customer will increase engagement and is highly encouraged.

FOOD DISPLAY

When displaying food, the following requirements must be followed:

Showcases must reinforce the Tenant's image and be an integral part of the design within the counter.

Glass must be tempered or a safety type. Plexiglas is not permitted.

Showcases shall not exceed 14" above counter and 36" overall width. It shall not be more than 50% of the counter length and located no closer than 48" from the neutral pier.

LAYOUT

Due to the high visibility of the Customer Service Area particular attention is given to the design review of this area. Service areas, furnishings, display cookery, food prep and cooking areas visible from the mall common area must meet strict design standards.

- Support rooms and storage shall be concealed from public view.
- A full-height partition wall must separate the Customer Service Area and Prep Area.
- Access to the Prep Area shall be via a self-closing door or between staggered "blind walls".



> DESIGN > QUEUE / PATIOS / SEATING

QUEUE AREAS

All food venues must provide a queue layout that allows for the Mall to maintain its code minimum distances for general circulation.

Stanchions are not allowed. Other indicators for customer directional flow will be considered.

PATIO AREAS

Exposed patios are encouraged however, they should not extend beyond the lease line. In special cases there may be opportunity to extend the patio but it must be in compliance with all common mall code, circulation requirements, and leasing agreements.

Projection or canopy may increase the visibility of the storefront over seating areas. They also help with lighting the Storefront.

- Common mall flooring must be maintained. Coordinate with Landlord design if railings or other elements will have an effect on the flooring.

SEATING

Where interior seating is needed or desired, it is suggested that the enclosure line be moved into the lease space by approximately 12 feet.

- Patio seating must be separated from the common area circulation in the Mall. A layout will be required.
- All visible furniture must be reviewed by the Landlord for suitability both aesthetically, as well as for performance specifications.
- Tenant is responsible to confirm additional requirements with the local authorities for any railing or barrier for the Tenant's proposed area.
- In some cases options for furniture may be supplied by the mall design team for the Tenant to choose from.



> COUNTER DESIGN / COUNTER ELEMENTS

FRONT SERVICE COUNTER DESIGN

- The form and materials used for counters shall be designed to be inviting to the public to help lure them to the space.
- Tenant to specify a protective edge at the bottom of the counter.
- Counter tops must be “Corian” or similar solid surface materials, metal or stone. Tenant counter and counter tops are to be custom designed and fabricated. Plastic laminate is prohibited.
- Plastic laminated countertops are prohibited.
- Maximum counter height is 3’-6”. Counter design, including heights, must comply with all accessibility guidelines enforced by national or local jurisdictions and the Americans with Disabilities Act.
- Sneeze guards shall be used above the front counters as required.

COUNTERTOP ELEMENTS

- Cash registers must be recessed so that they extend no more than 9” above the counter top.
- Condiment and utensil displays or dispensers must be fully recessed into the counter.
- Fully-recessed counter-top trash receptacles (for straw wrappers, etc.) must be provided near the condiment and utensil displays.
- Drink dispenser and other utilitarian kitchen equipment may not be placed on the front counter.



> MATERIALS / LIGHTING / FLOORING

FRONT SERVICE COUNTER AND STOREFRONT MATERIALS

All finish materials must be backed by a minimum 5/8" solid surface material and may include the following:

- Counter tops must be solid surface materials, metal or stone. Tenant counter and counter tops are to be custom designed and fabricated.
- All stone/tile colors must be integral throughout.
- Metal panels and architectural hardware shall have a professional and durable finish.
- Color anodized, baked painted or antique finish
- Wood veneers and weathered or distressed wood (submit specification for approval)
- Resin panels such as 3-Form products
- Back-painted tempered glass panels
- Glass tiles

Finish materials shall NOT include the following materials:

- 4"x4", 6"x6", 12"x12" glazed tiles
- Shingles or boards
- Plastic laminate
- Faux or plastic formed brick, block or stone
- Clear anodized aluminum
- Other materials as deemed unacceptable by Landlord.

LIGHTING

Tenants must light both their storefront as well as the countertop. Lighting on architectural elements and menu boards are required.

FLOORING

All "wet" areas must install a waterproof membrane that is tested and confirmed by the Landlord. Full requirements can be found in the plumbing section of the [INLINE TECHNICAL CRITERIA](#).



> SIGNAGE > PRIMARY / MENU BOARDS

PRIMARY STOREFRONT SIGN

Inline and Restaurant Food Tenants must adhere to the signage requirements found in the [INLINE SIGN CRITERIA](#).

MENU BOARDS

Inline and Restaurant Food Tenants must adhere to the menu board requirements found in the [FOOD COURT SIGN CRITERIA](#).

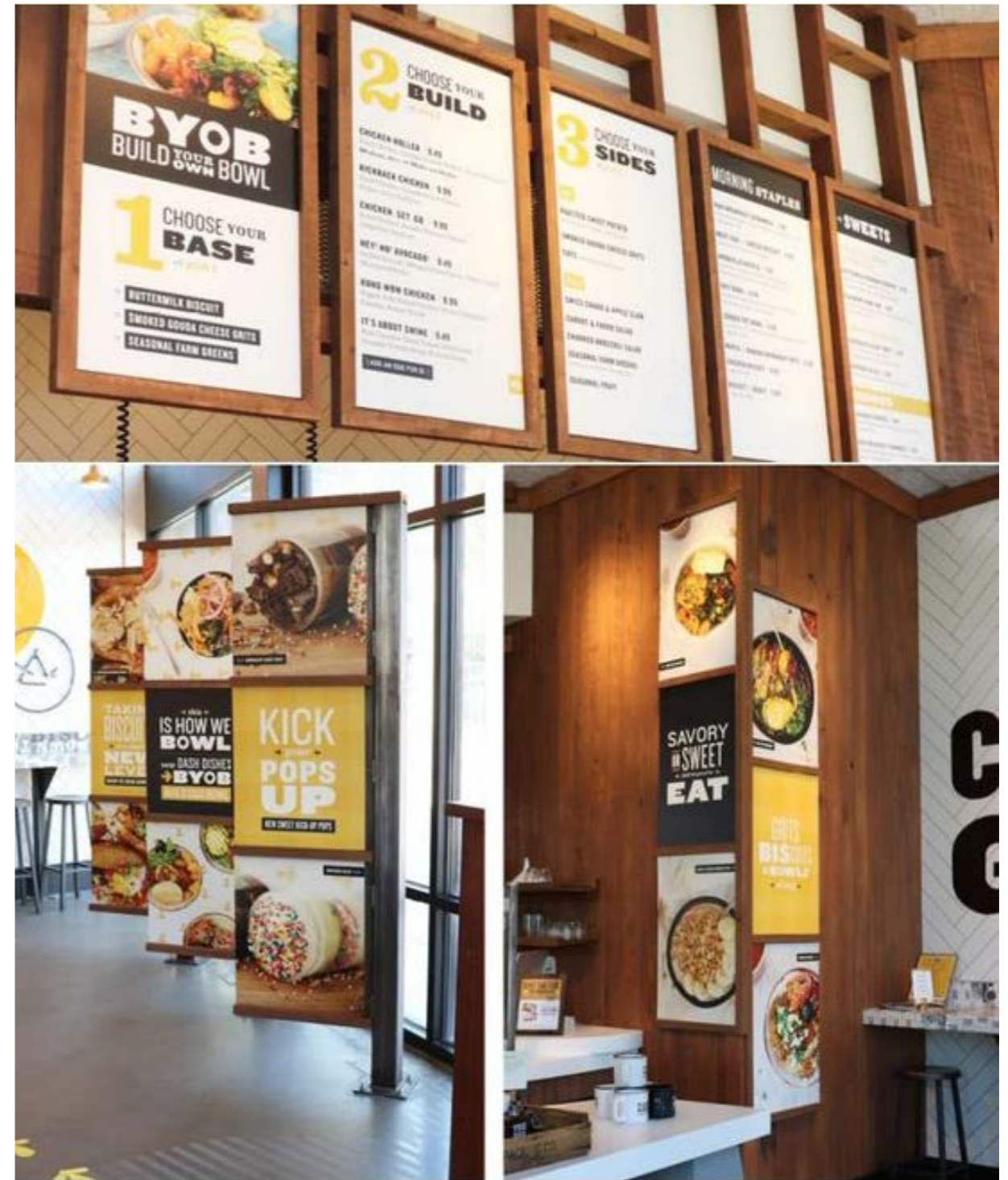

> TECHNICAL

Inline and Restaurant Food Tenants must adhere to the technical requirements found in the [INLINE TECHNICAL CRITERIA](#).

In addition to the requirements detailed in the Technical Criteria, Tenants cooking food in their space must adhere to the following:

GENERAL REQUIREMENTS

- **KITCHEN SINKS** including pot sinks, scullery sinks, pre-wash sinks and other kitchen units must be connected to a grease trap.
- **DISHWASHERS** may not be connected to grease trap.
- **GREASE INTERCEPTOR** must be designed and approved by Landlord prior to installation, especially if located outside the lease line.
- **OIL COLLECTION AND HAULING SYSTEM** is required for Tenants with fryers or other grease/oil generating equipment that does not run through an interceptor. Landlord does not provide a centralized collection point.
- **BACKFLOW PREVENTERS** are required for food service, hair salons or other Tenants with equipment or operations that have the possibility of backflow. These must be certified and acceptable to the water district and checked yearly or as required by the local authority having jurisdiction.

KITCHEN EXHAUST REQUIREMENTS

- **LANDLORD REVIEW** is required to ensure the exhaust does not compromise the ventilation air of adjacent mall roof top units.
- **EXHAUST FAN** must be a SWSI centrifugal fan fitted with a minimum 10'-0" stainless steel upblast. Guy wires must be attached to the roof to secure the stack.
- **GREASE GUARD** containment system must be installed to protect the roof. Quarterly maintenance program is required for the grease containment system. Proof of maintenance contract must be presented to the Landlord prior to opening.
- **"SUPREME" HEAVY DUTY GBD BLOWERS** are required for all kitchen exhaust or grease laden air removal.

FUMES AND ODORS

The following constitutes the minimum requirements for special exhaust systems which Tenant must furnish and install in the Leased Premises for the elimination of fumes and odors due to Tenant operations:

- A total negative pressure of ten percent (10%) must be maintained during all hours that Tenant is operating its business in the Leased Premises.
- The HVAC system must be modified to provide additional make-up supply air to offset the quantity of air exhausted.
- The Tenant must have a certified air balancing contractor test the completed system and verify its operation according to these specifications. A copy of the air balancing report must be submitted to the Mall General Manager for review and approval prior to opening for business.
- The combined HVAC and exhaust system per the above-noted specifications must be in operation during all hours that Tenant is operating its business in the Leased Premises.
- The combined HVAC system must be connected to the Landlord EMS by the Landlord required contractor. See the Technical Criteria section for specifics.
- Indoor tenants which will be using any type of gas, liquid or solid fuel for heating, cooking or other use, must have an active carbon monoxide detector installed. The type should be and Hardwire Interconnectable 120- Volt Carbon Monoxide Alarm with Digital Display and Battery Backup.
- Carbon dioxide detection is required if tenant has a carbon dioxide systems with 100 lbs. or more of carbon dioxide used in their beverage dispensing applications.

RESTAURANT SPECIFIC REQUIREMENTS

- **PLANS MUST SHOW** sizes and locations for all duct and piping through roof as well as all required fireproofing.
- **CONTAIN ALL GARBAGE AND REFUSE AREAS WASH DOWN** "grey" water and properly drain off into city approved system (i.e. sewer or storm).

GAS UTILITY

Gas is available for cooking equipment only. Service is available through Philadelphia Gas Works and is located on site in a Central Gas Room. Tenants requiring gas service for cooking are required to:

- **SET UP A UTILITY ACCOUNT** direct with Philadelphia Gas Works for gas service and billing.
- **INSTALL ALL EQUIPMENT AND PIPING** for space gas service including piping from the Gas Room to the Tenant space, any necessary venting, and piping inside the Tenant space.

RESTAURANTS > CONTENTS

- DESIGN**
 - STOREFRONT / PREPARATION AS THEATER*
 - CONTROL AREAS / SEATING*
 - EXTERIOR*
- SIGNAGE**
 - STOREFRONT / MENU BOARDS*
- TECHNICAL**

SECTIONS OF INTEREST

- INLINE CRITERIA**

Includes standard design, technical, and sign requirements in addition to the contents in this section.
- DESIGN INSPIRATION**

Provides design inspirations for visual aesthetics.
- BUILDING DETAILS**

Includes Property reference photos and specific Storefront design details.
- PROPERTY INFO**

Includes information on the Property's building codes, area permitting, and required contractors.
- SUBMITTALS**

Outlines requirements on how and what to compile for submittals to the Landlord for design reviews.

The Restaurant Criteria provides key technical information and design requirements to ensure your interior or exterior facing restaurant food service enlivens the consumer experience and interfaces with the Center.

This criteria will often point to the [INLINE RETAIL CRITERIA](#) as several requirements and design concepts are shared. The content in this section highlights the unique concepts for food service design.

The Tenant and the Tenant's architect assume the following important obligations:

- Fulfill the intent of the criteria both in concept and in detail.
- Determine and respond to the actual physical conditions of the Tenant's location.
- Maintain and enhance the high standards of quality established in the construction of the Center.
- Ensure the quality of execution of all design material, finish, and detail concepts in the construction of the Tenant's improvement.
- Provide the required detail at all transitions from Tenant storefront to neighboring storefronts, as well as to the base building.



> DESIGN > STOREFRONT / PREPARATION AS THEATER

Restaurant Food Tenants must adhere to the design requirements found in the [INLINE DESIGN CRITERIA](#).

In addition to the requirements detailed in the Design Criteria, Tenants serving food in their space must adhere to the following design requirements:

GENERAL STOREFRONT AND DESIGN

We encourage a cohesive presentation of the brand within the context of the whole Mall design, while the individual brand is important and the two must harmonize. Design should be tailored to its location both within the community and the whole Center's aesthetics.

Restaurants may face both the interior and the exterior, and are often located adjacent to a Mall entry. The exterior and the interior are subject to different Criteria standards, both for presentation and signage.

Interior restaurants oftentimes have a waiting area within the common space.

- If needed these must be shown in the submissions and be approved by Landlord. They must be coordinated with common area needs and code requirements.

PREPARATION AS THEATER

Tenant's offering a peek into the making of food, by nature, include the customer and make for an authentic experience. This inclusion of the Customer will increase engagement and is highly encouraged.



> CONTROL AREAS / SEATING

CONTROL AREAS

The Design Control Area (DCA) is the area at the front of the Tenant space that extends from the Lease Line to all points 6'-0" into the space. It should convey excitement and give the consumer a reason to engage.

Exposed patios are encouraged however, they should not extend beyond the lease line. In special cases there may be opportunity to extend the patio but it must be in compliance with all common mall code and circulation requirements.

Projection or canopies may increase the visibility of the storefront over seating areas. They also help with lighting the storefront.

In addition to the general DCA criteria for inline stores the following requirements must be met:

- All patio rails, reception podiums, waiting areas, menu presentations, lighting, heating, visible banquet detailing, and material palates must be presented for review and approval.
- Common mall flooring must be maintained. Coordinate with Landlord design if railings or other elements will have an effect on the flooring.

SEATING

Where interior seating is needed or desired, it is suggested that the enclosure line be moved into the lease space by approximately 12 feet.

Seating design requirements include:

- Patio seating must be separated from the common area circulation in the Mall. A layout will be required for review.
- All visible furniture must be reviewed by the Landlord for suitability both aesthetically, as well as for performance specifications.
- Tenant is responsible to confirm additional requirements with the local authorities for any railing or barrier for the Tenant's proposed area.



> EXTERIOR

Restaurants with exterior Storefronts will be subject to the general Criteria in this manual, for aesthetics.

Exterior design should be tailored to its location both within the community as well as the whole Mall and its aesthetics.

SITE PLANS

- A Site Plan must be submitted that includes all required calculations for GLA, GBA, and parking requirements.
- Site Circulation must be included showing the adjacent intersections, driveways, drive directions, and dimensions of all access points.
- Photos of adjacent and onsite conditions may be required by ownership for the review process.

AMENITIES

- Planters, heat lamps, tables, chairs etc., must be submitted for approval. All amenities must be commercial grade and suitable for outdoor use.
- Pendant or sconce lighting must be submitted for approval by Landlord.
 - Lighting plans of canopies and trellis are available in Landlord supplied base drawings.
- Umbrellas are only allowed in the designated areas and cannot overhang into the public right-of-way.
 - Umbrellas should be small in scale (maximum 6'-0" in diameter) and no more than 9'-0" high at the peak.
 - Wood or metal are the only acceptable materials for the umbrella structure. No insignia, graphics or text are permitted on the umbrella fabric.
 - The umbrella fabric must be flame retardant material in a color approved by Landlord's Tenant Coordinator.

EXTERIOR PATIOS

- Any changes to an existing patio must be approved by Landlord. Tenant is responsible to confirm the requirements with the local municipality for proposed use.
- Temporary elements such as greeting stands, waiting areas must be submitted for review.
- Confirm code height and density of railings for of any necessary barriers.
- Patio layouts with adjacent circulation dimensioned must be included in the first submittal of documents for design review.
- Railing design details should be submitted with the concept and construction packages for approval by the Landlord design team.

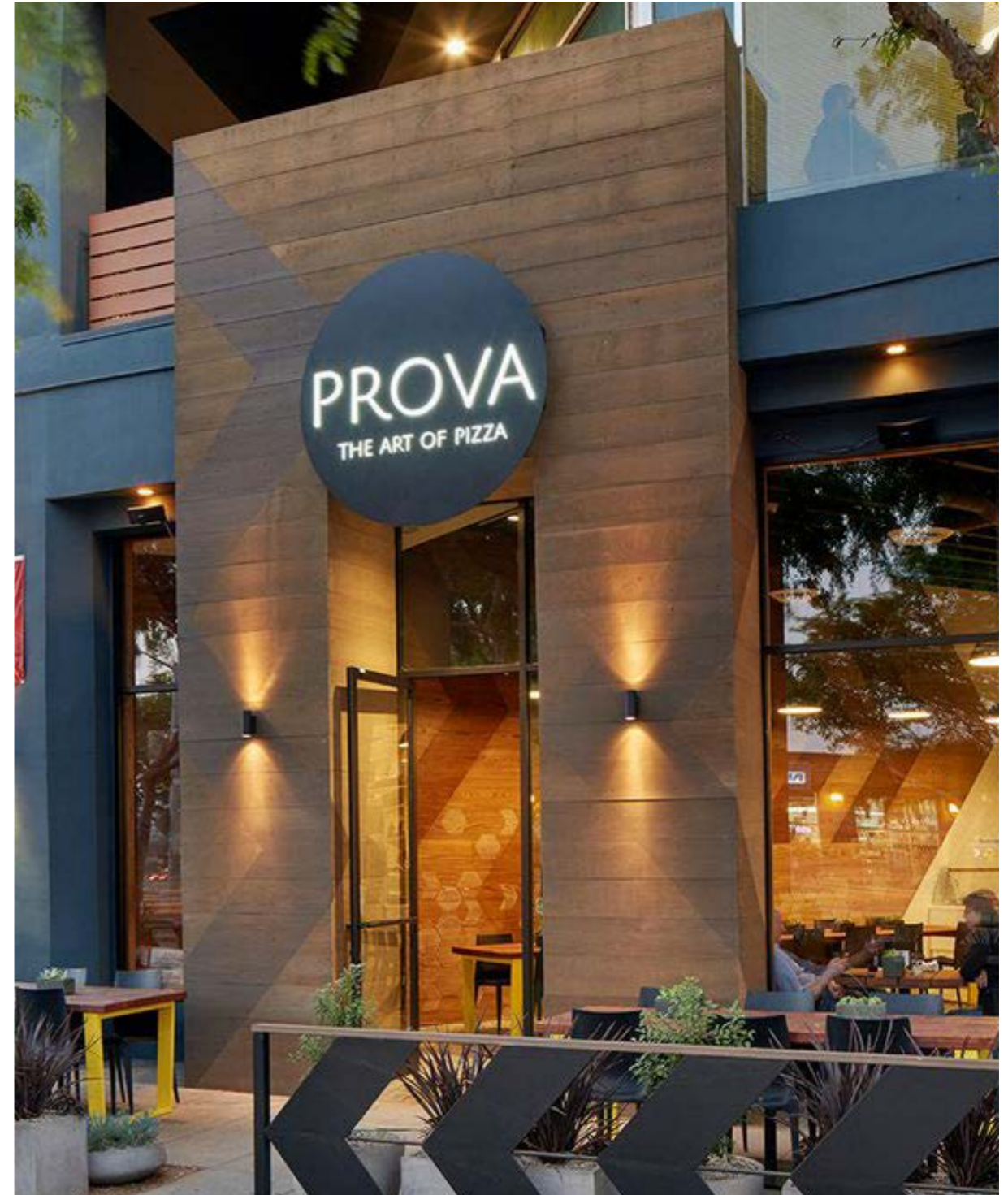

> SIGNAGE > PRIMARY / MENU BOARDS

PRIMARY STOREFRONT SIGN

Inline and Restaurant Food Tenants must adhere to the Signage requirements found in the [INLINE SIGN CRITERIA](#).

Exterior signage must adhere to the requirements established by the local municipality.

MENU BOARDS

Inline and Restaurant Food Tenants must adhere to the menu board requirements found in the [FOOD COURT SIGN CRITERIA](#).



> TECHNICAL

Inline and Restaurant Food Tenants must adhere to the technical requirements found in the [INLINE TECHNICAL CRITERIA](#).

In addition to the requirements detailed in the Technical Criteria, Tenants cooking food in their space must adhere to the same requirements found in the [INLINE FOOD TECHNICAL CRITERIA](#).

BUILDING DETAILS CONTENT OVERVIEW

3.1

ZONE MAP

INTERACTIVE MAP HIGHLIGHTING EACH STOREFRONT DESIGN ZONE.

3.2

STOREFRONT ZONE DETAILS

DETAILS SPECIFIC STOREFRONT DESIGN REQUIREMENTS BASED ON YOUR STORE'S LOCATION IN THE CENTER.

3.3

NEUTRAL PIER DETAILS

ARCHITECTURAL DETAILS OF THE VARIOUS NEUTRAL PIER CONDITIONS WITHIN THE CENTER.

3.4

EXPANSION JOINT DETAILS

ARCHITECTURAL DETAILS OF THE VARIOUS EXPANSION JOINT CONDITIONS WITHIN THE CENTER.

This section provides design details and additional requirements based on your store's location within the Center.

Refer to the interactive map on the following pages to determine your store's specific zone. The Tenant and Tenant's Architect are responsible for following the specific zone requirements, adopting the correct neutral pier condition, and addressing the specific expansion joint condition if applicable within the Tenant space.







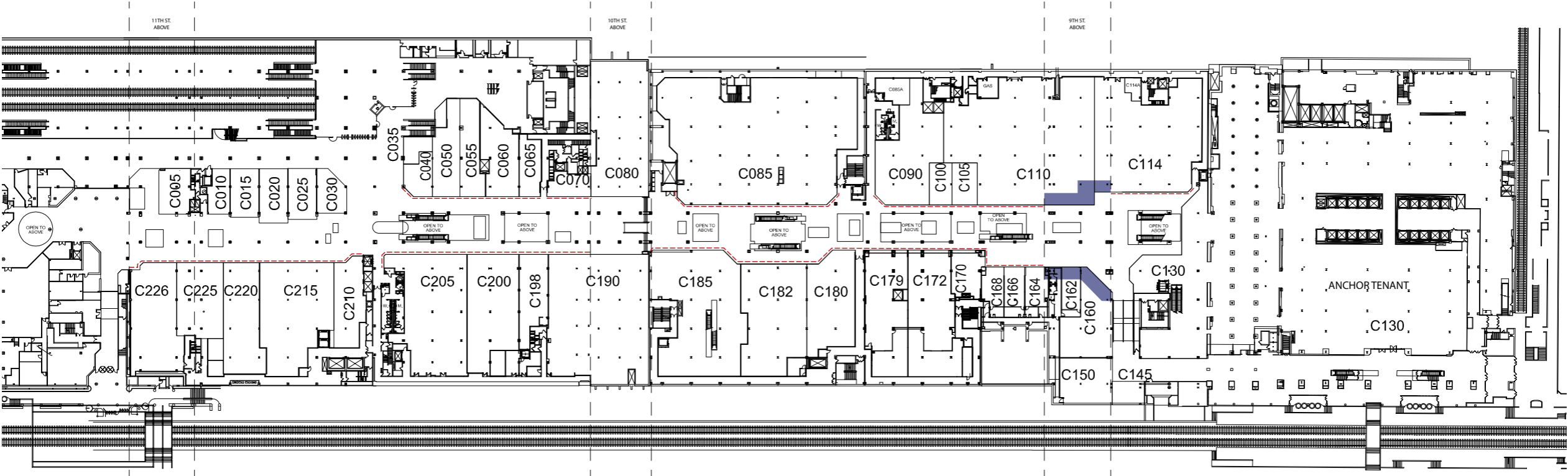





BUILDING DETAILS > ZONE MAP > CONCOURSE LEVEL

This section provides storefront design details, requirements, and visual references specific to the primary zones located within Fashion District Philadelphia. These are additional design requirements that must be followed to ensure your store correctly interfaces with the immediate surroundings. Click or tap on a colored Zone to navigate directly to that Zone's details.



STOREFRONT HEIGHTS - CONCOURSE LEVEL

ZONE 1A		11'-10" +/-	ZONE 5		11'-3" +/-
ZONE 1B		11'-0" +/-	ZONE 6		NOT USED
ZONE 2		12'-10" +/-	ZONE 7		10'-0" +/-
ZONE 3		12'-6" +/-	ZONE 8		9'-6" +/-
ZONE 4		12'-1" +/-	ZONE 9		VARIES, REFERENCE FOOD HALL CRITERIA







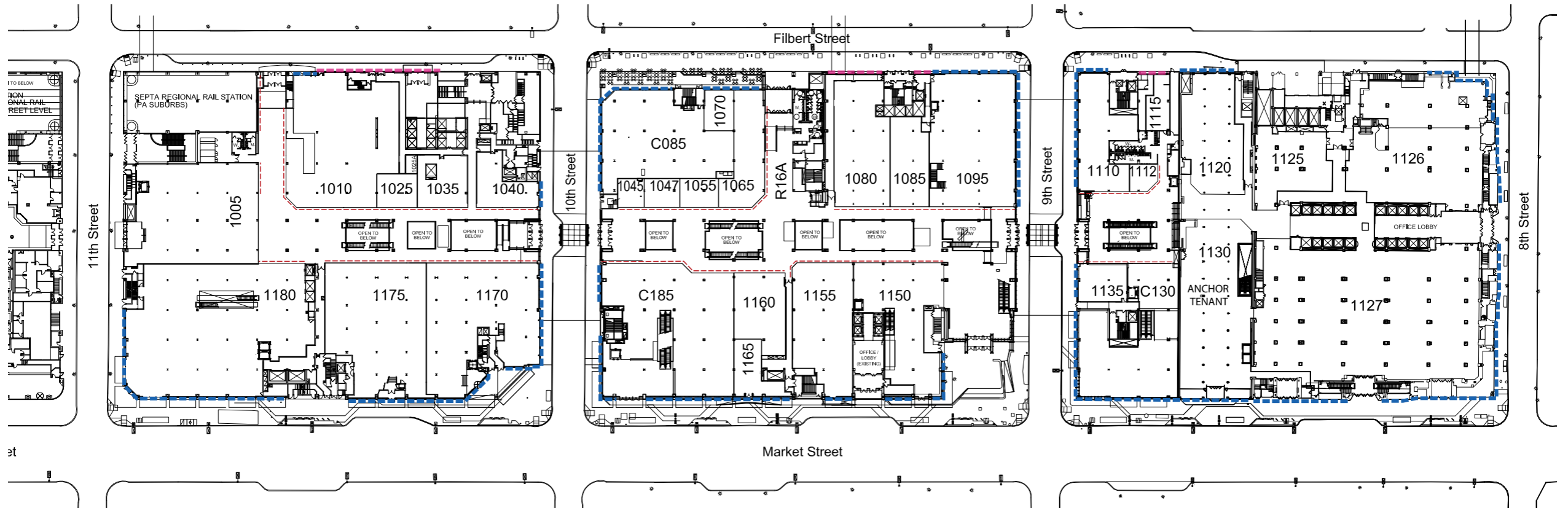

 BULKHEAD W/ INTEGRATED HVAC DIFFUSER ZONE WHERE REQUIRED.
(REF. MECH. DRAWINGS)

*PLEASE NOTE: ALL STOREFRONT HEIGHTS SHOULD BE VERIFIED AGAINST AS-BUILT CONDITIONS IN THE FIELD.

> ZONE MAP > STREET LEVEL



STOREFRONT HEIGHTS - STREET LEVEL

ZONE 10		18'-0" +/-	ZONE 15		10'-9" +/-
ZONE 11		10'-4" +/-	ZONE 16		EXTERIOR LIFESTYLE GRAPHICS ZONE
ZONE 12		10'-0" +/-	ZONE 17		EXTERIOR FACADE MODIFICATION LIMITS
ZONE 13		12'-0" +/-			
ZONE 14		14'-6" +/-			

 BULKHEAD W/ INTEGRATED HVAC DIFFUSER ZONE WHERE REQUIRED.
(REF. MECH. DRAWINGS)

> ZONE MAP > SECOND LEVEL

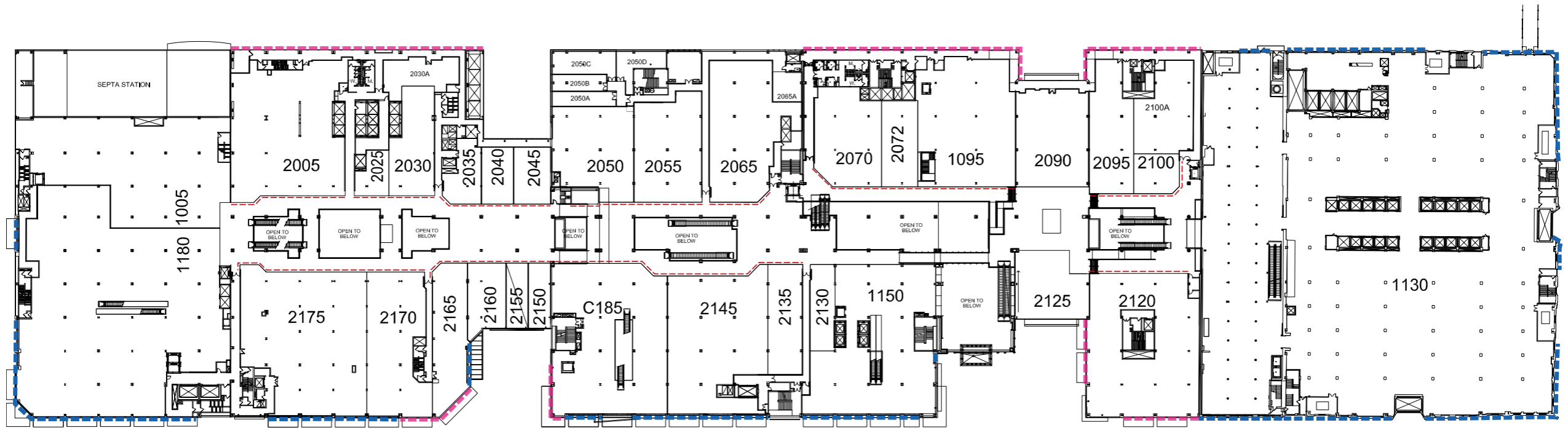

STOREFRONT HEIGHTS - SECOND LEVEL

- ZONE 16 ■■■ EXTERIOR LIFESTYLE GRAPHICS ZONE
- ZONE 17 ■■■ EXTERIOR FACADE MODIFICATION LIMITS
- ZONE 18 ■■■ 14'-0" +/-
- ZONE 19 ■■■ 12'-6" +/-
- ZONE 20 ■■■ 11'-0" +/-
- ZONE 21 ■■■ 10'-0" +/-
- ZONE 22 ■■■ 7'-10" +/-

--- BULKHEAD W/ INTEGRATED HVAC DIFFUSER ZONE WHERE REQUIRED.
(REF. MECH. DRAWINGS)

*PLEASE NOTE: ALL STOREFRONT HEIGHTS SHOULD BE VERIFIED
AGAINST AS-BUILT CONDITIONS IN THE FIELD.

> ZONE MAP > THIRD LEVEL

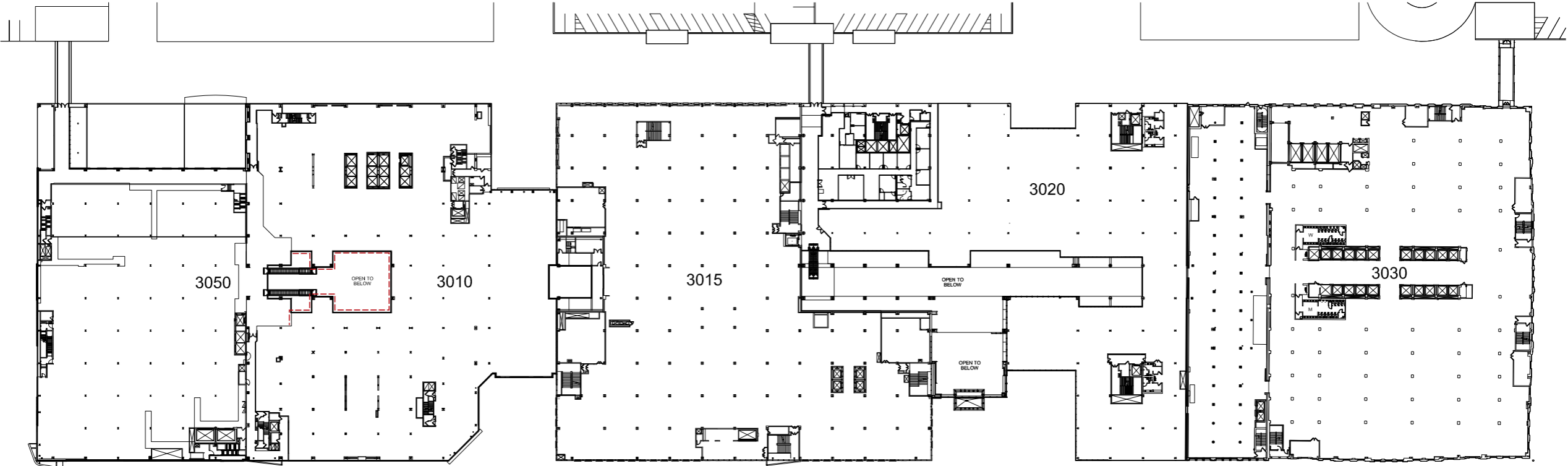

STOREFRONT HEIGHTS - THIRD LEVEL

- ZONE 23 10'-6" +/-
- ZONE 24 11'-6" +/-

--- BULKHEAD W/ INTEGRATED HVAC DIFFUSER ZONE WHERE REQUIRED.
(REF. MECH. DRAWINGS)

*PLEASE NOTE: ALL STOREFRONT HEIGHTS SHOULD BE VERIFIED AGAINST AS-BUILT CONDITIONS IN THE FIELD.

> ZONE DETAILS > ZONE 1

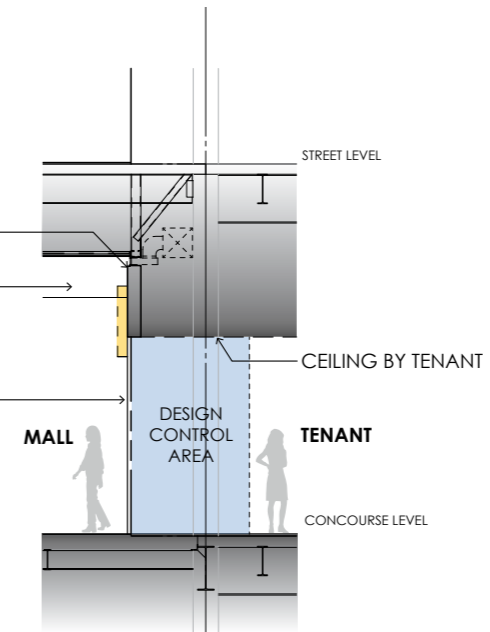
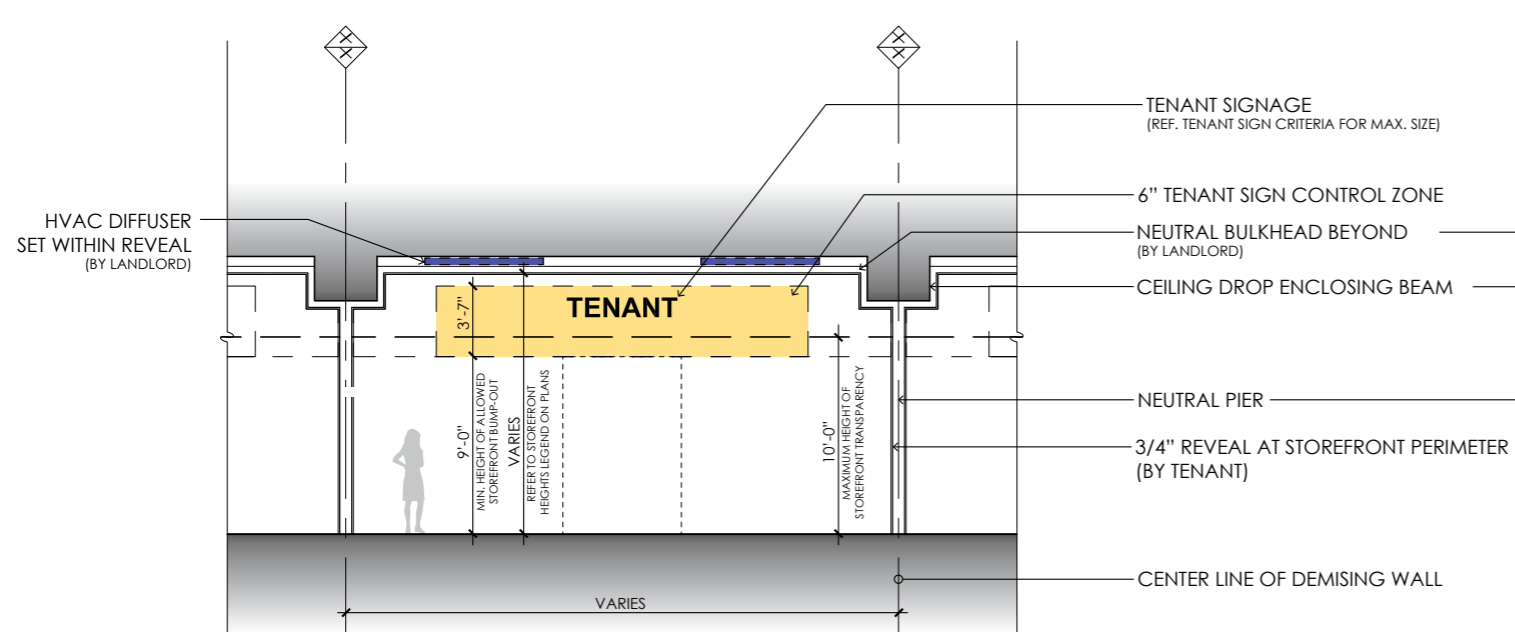

STOREFRONT ZONE 1A, 1B CRITERIA

1. TENANT SHALL MAXIMIZE CEILING HEIGHT WITHIN THEIR PREMISES.
2. TENANT IS RESPONSIBLE FOR VERIFYING ALL CONDITIONS IN FIELD.
3. TENANT ENTRY / PORTAL IS REQUIRED TO BE A MINIMUM OF 9'-0" IN HEIGHT.
4. DESIGN CONTROL ZONE TO EXTEND 8'-0" INTO TENANT PREMISES.
5. SIGNAGE SHALL NOT PROJECT BEYOND LEASE LINE UNLESS WITHIN TENANT CONTROL ZONE.

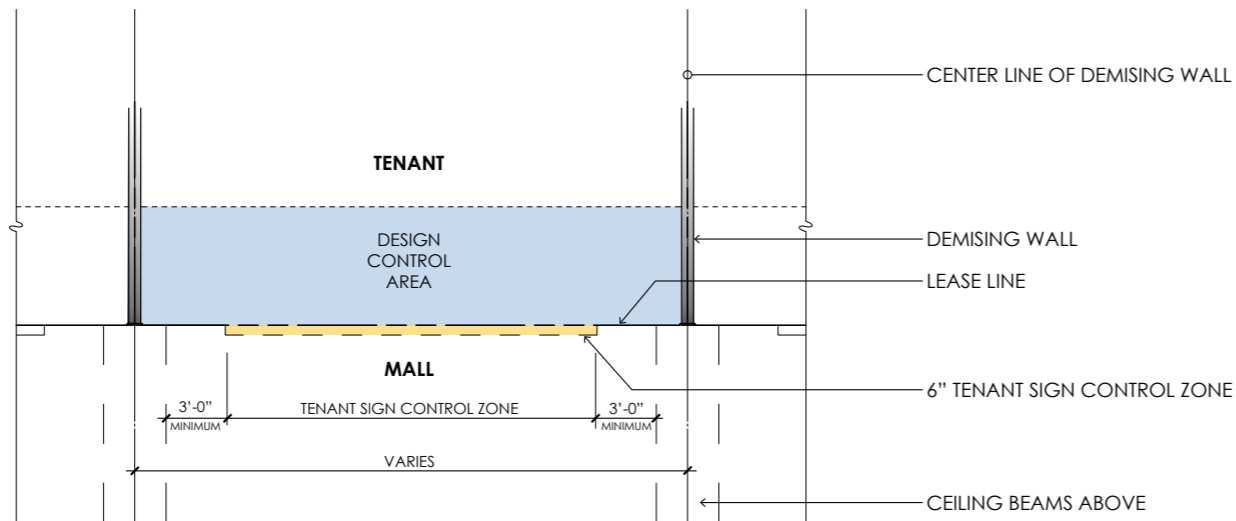

> ZONE DETAILS > ZONE 12

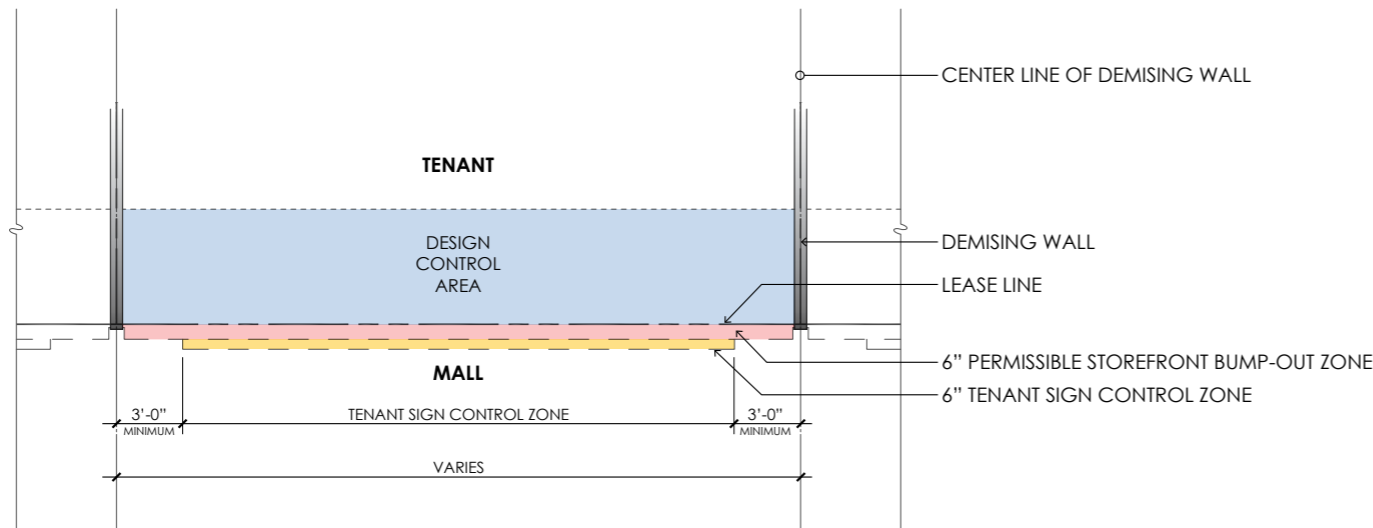
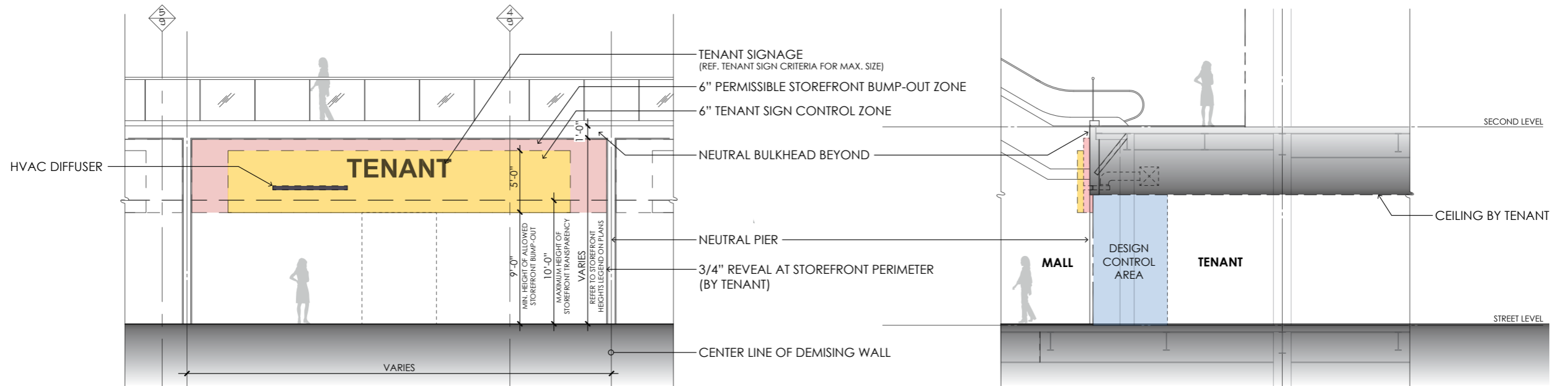

STOREFRONT ZONE 12 CRITERIA

1. TENANTS MUST ALLOW FOR AND INTEGRATE HVAC DIFFUSER ZONE INTO THE DESIGN OF THEIR STOREFRONT IN A MANNER THAT MAKES IT LESS CONSPICUOUS TO THE GENERAL PUBLIC. HVAC DIFFUSERS VARY BY LOCATION. REFERENCE TENANT LOD.
2. TENANT SHALL MAXIMIZE CEILING HEIGHT WITHIN THEIR PREMISES.
3. TENANT IS RESPONSIBLE FOR VERIFYING ALL CONDITIONS IN FIELD.
4. TENANT ENTRY / PORTAL IS REQUIRED TO BE A MINIMUM OF 9'-0" IN HEIGHT.
5. DESIGN CONTROL ZONE TO EXTEND 8'-0" INTO TENANT PREMISES.
6. SIGNAGE SHALL NOT PROJECT BEYOND LEASE LINE UNLESS WITHIN TENANT CONTROL ZONE.

> ZONE DETAILS > ZONES 2-4, 15, 19-21, 23

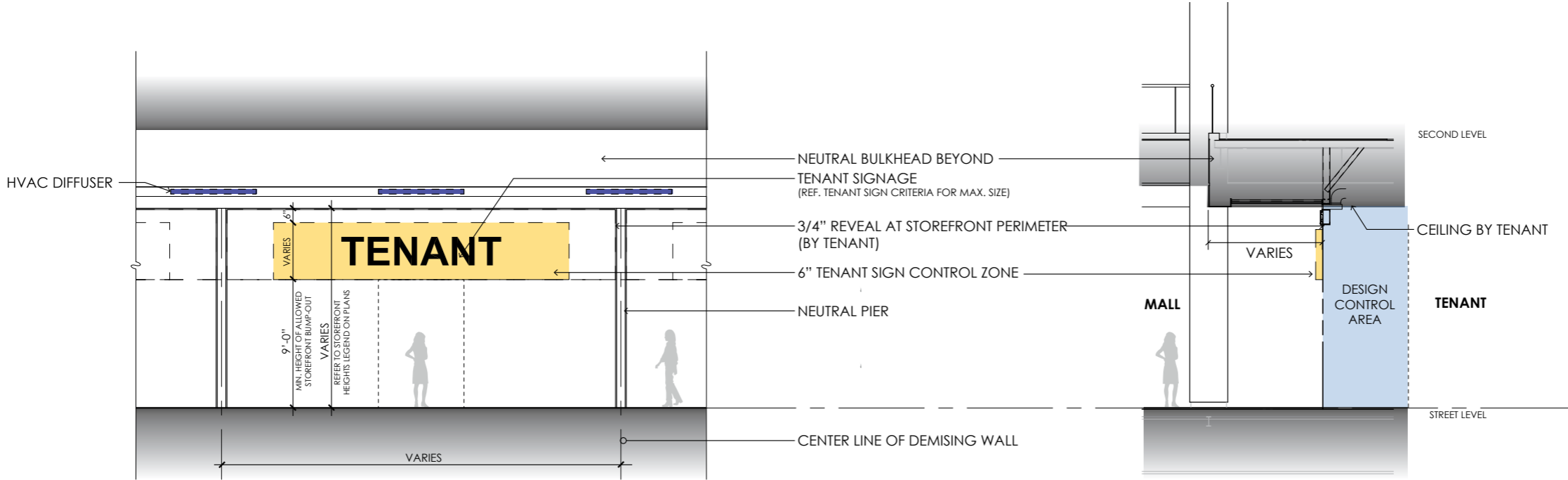

STOREFRONT ZONE 2-4, 15, 19-21, 23 CRITERIA

1. TENANT SHALL MAXIMIZE CEILING HEIGHT WITHIN THEIR PREMISES.
2. TENANT IS RESPONSIBLE FOR VERIFYING ALL CONDITIONS IN FIELD.
3. TENANT ENTRY / PORTAL IS REQUIRED TO BE A MINIMUM OF 9'-0" IN HEIGHT.
4. DESIGN CONTROL ZONE TO EXTEND 8'-0" INTO TENANT PREMISES.
5. SIGNAGE SHALL NOT PROJECT BEYOND LEASE LINE UNLESS WITHIN TENANT CONTROL ZONE.

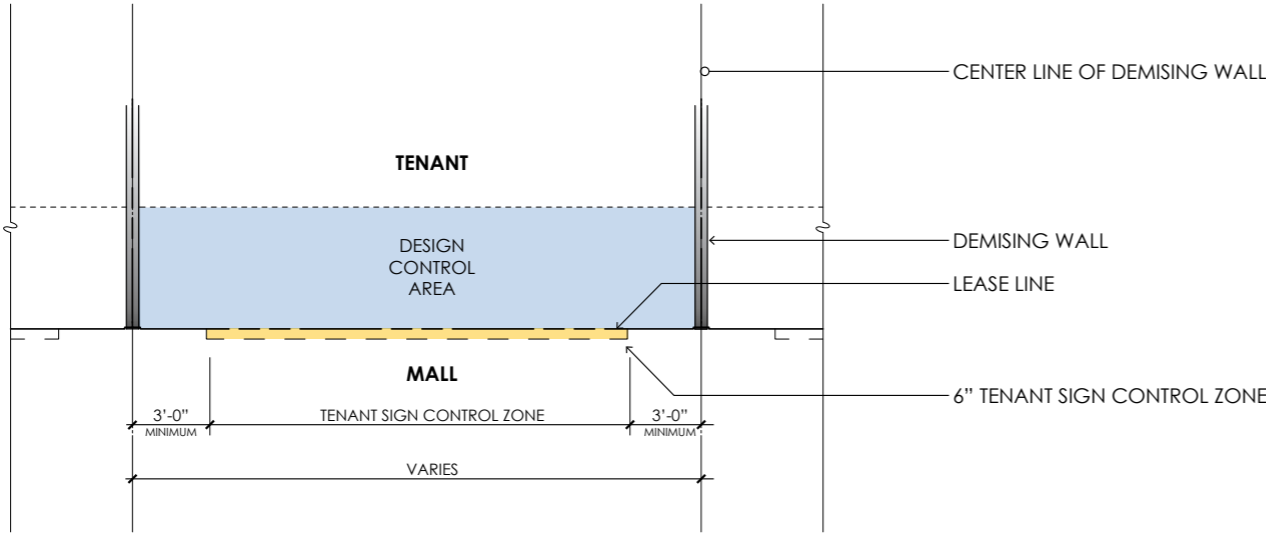

> ZONE DETAILS > ZONES 7 & 8

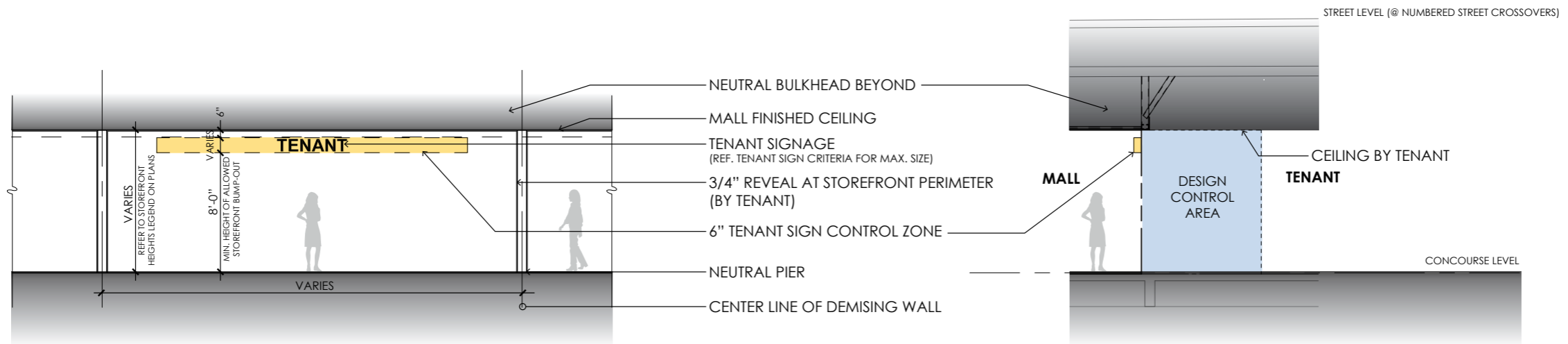

STOREFRONT ZONE 7, 8 CRITERIA

1. TENANT SHALL MAXIMIZE CEILING HEIGHT WITHIN THEIR PREMISES.
2. TENANT IS RESPONSIBLE FOR VERIFYING ALL CONDITIONS IN FIELD.
3. TENANT ENTRY / PORTAL IS REQUIRED TO BE A MINIMUM OF 8'-0" IN HEIGHT.
4. DESIGN CONTROL ZONE TO EXTEND 8'-0" INTO TENANT PREMISES.
5. SIGNAGE SHALL NOT PROJECT BEYOND LEASE LINE UNLESS WITHIN TENANT CONTROL ZONE.

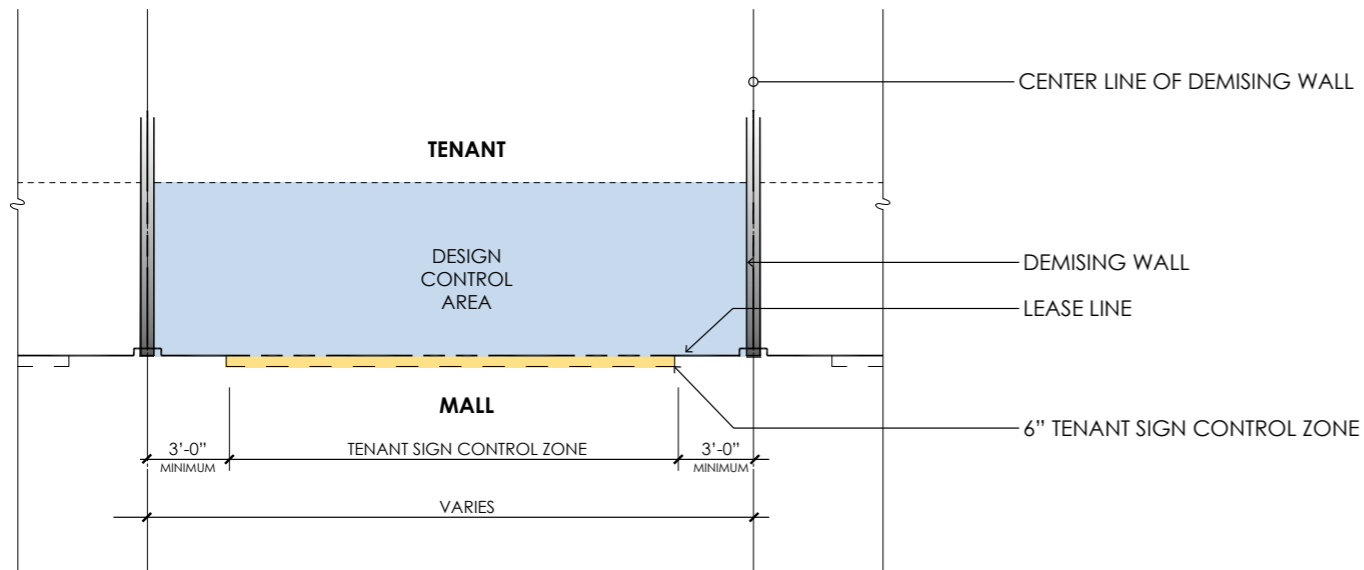

> ZONE DETAILS > ZONES 5 & 24

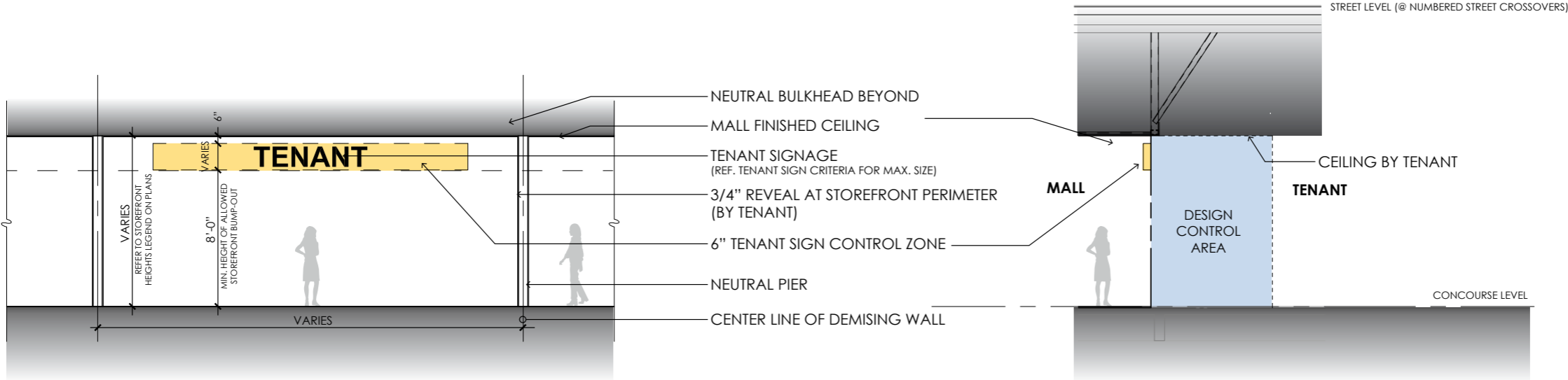

STOREFRONT ZONE 5, 24 CRITERIA

1. TENANT SHALL MAXIMIZE CEILING HEIGHT WITHIN THEIR PREMISES.
2. TENANT IS RESPONSIBLE FOR VERIFYING ALL CONDITIONS IN FIELD.
3. TENANT ENTRY / PORTAL IS REQUIRED TO BE A MINIMUM OF 8'-0" IN HEIGHT.
4. DESIGN CONTROL ZONE TO EXTEND 8'-0" INTO TENANT PREMISES.
5. SIGNAGE SHALL NOT PROJECT BEYOND LEASE LINE UNLESS WITHIN TENANT CONTROL ZONE.

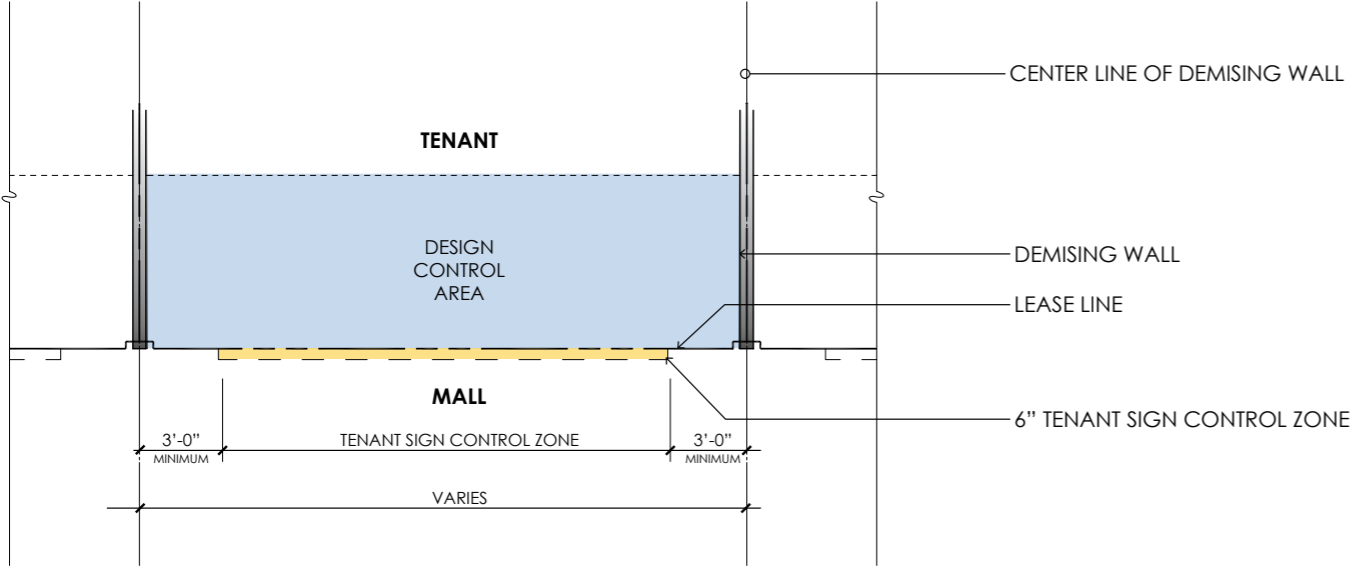

> ZONE DETAILS > ZONE 22

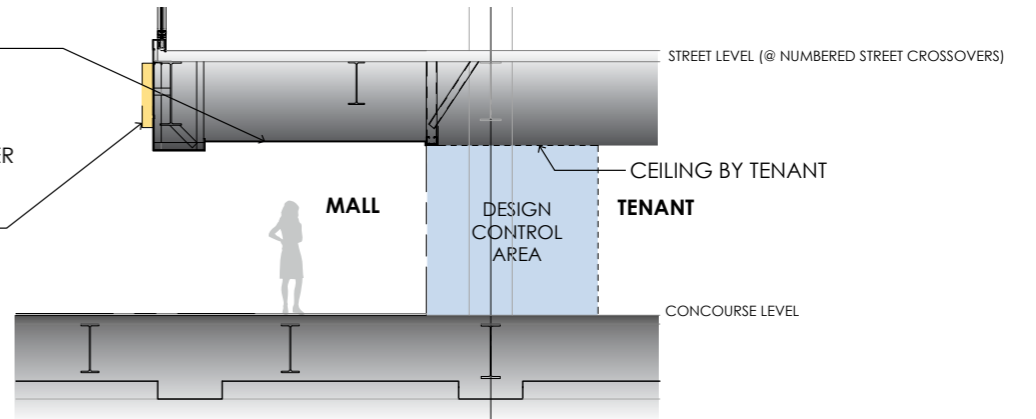
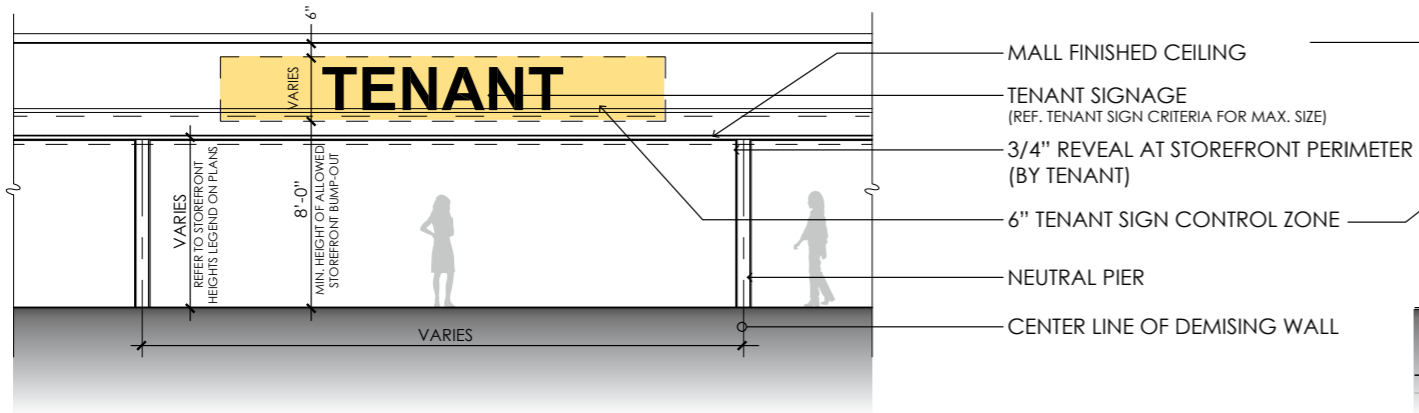

STOREFRONT ZONE 22 CRITERIA

1. TENANT SHALL MAXIMIZE CEILING HEIGHT WITHIN THEIR PREMISES.
2. TENANT IS RESPONSIBLE FOR VERIFYING ALL CONDITIONS IN FIELD.
3. TENANT ENTRY / PORTAL IS REQUIRED TO BE A MINIMUM OF 8'-0" IN HEIGHT.
4. DESIGN CONTROL ZONE TO EXTEND 8'-0" INTO TENANT PREMISES.
5. SIGNAGE SHALL NOT PROJECT BEYOND LEASE LINE UNLESS WITHIN TENANT CONTROL ZONE.

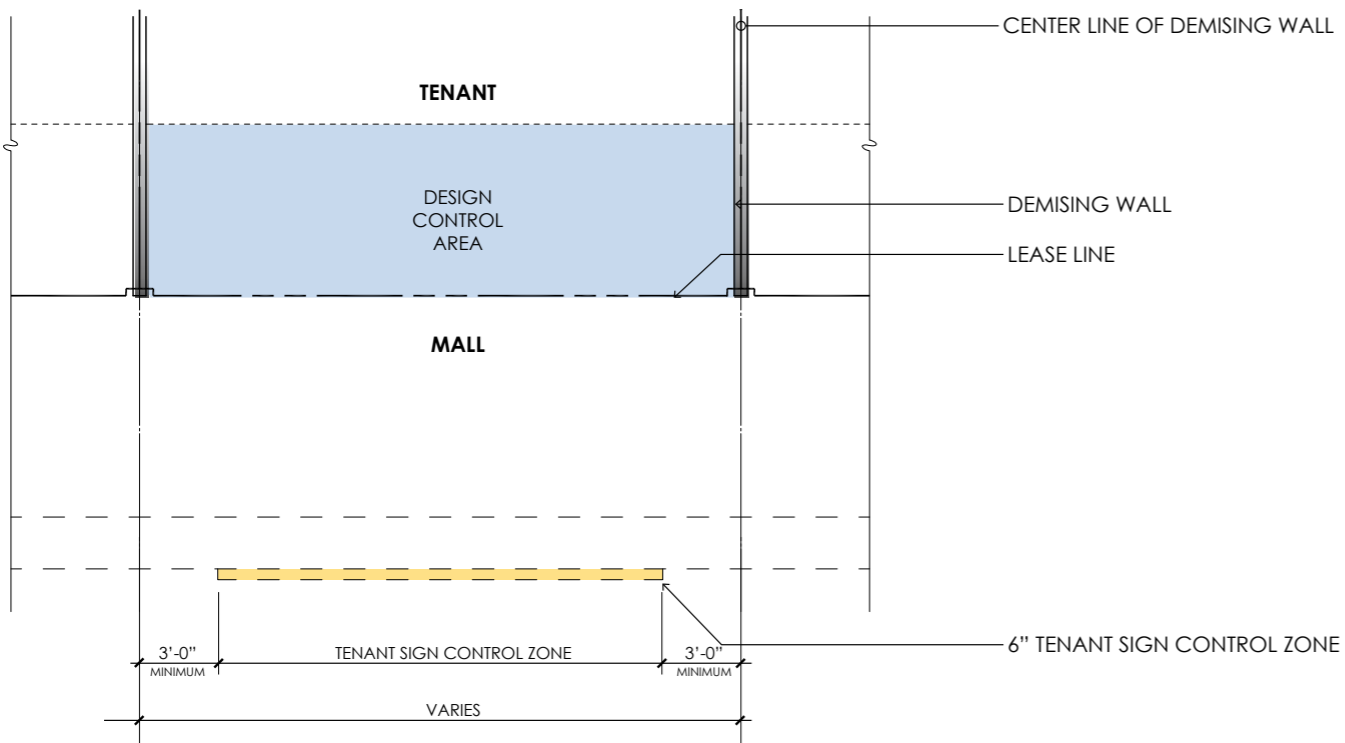

> ZONE DETAILS > ZONE 11

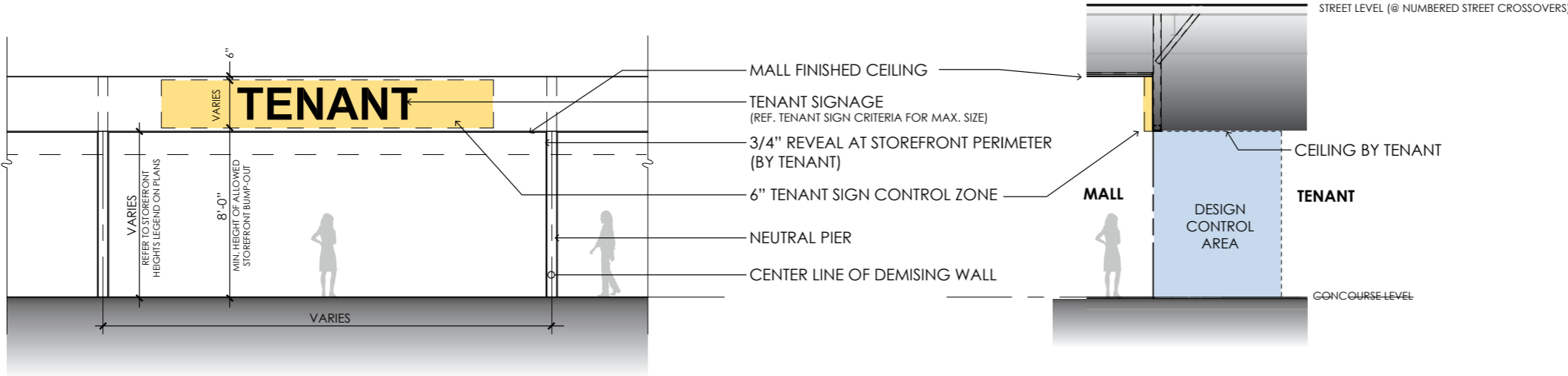

STOREFRONT ZONE 11 CRITERIA

1. TENANT SHALL MAXIMIZE CEILING HEIGHT WITHIN THEIR PREMISES.
2. TENANT IS RESPONSIBLE FOR VERIFYING ALL CONDITIONS IN FIELD.
3. TENANT ENTRY / PORTAL IS REQUIRED TO BE A MINIMUM OF 8'-0" IN HEIGHT.
4. DESIGN CONTROL ZONE TO EXTEND 8'-0" INTO TENANT PREMISES.
5. SIGNAGE SHALL NOT PROJECT BEYOND LEASE LINE UNLESS WITHIN TENANT CONTROL ZONE.

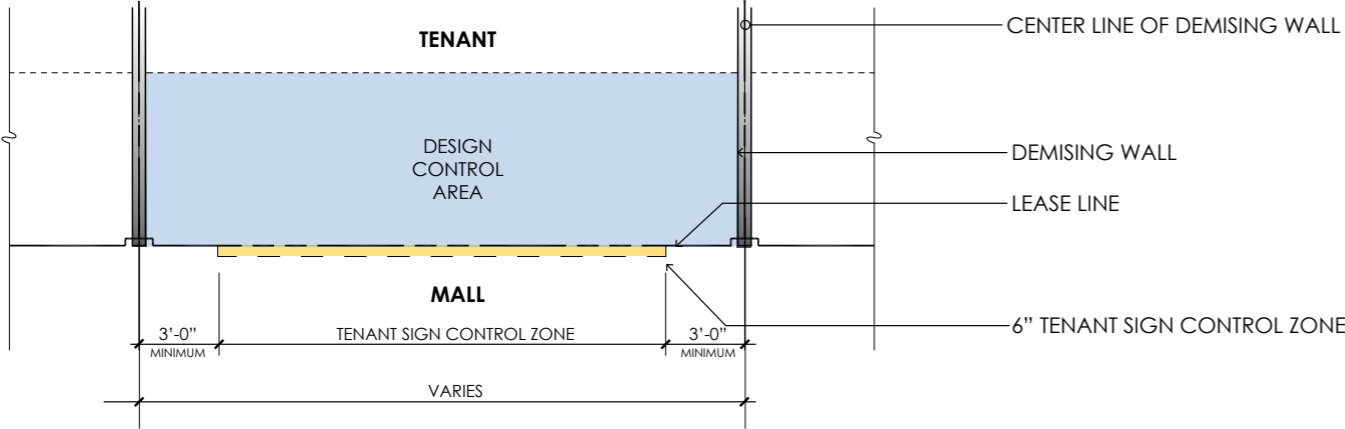

> ZONE DETAILS > ZONE 18

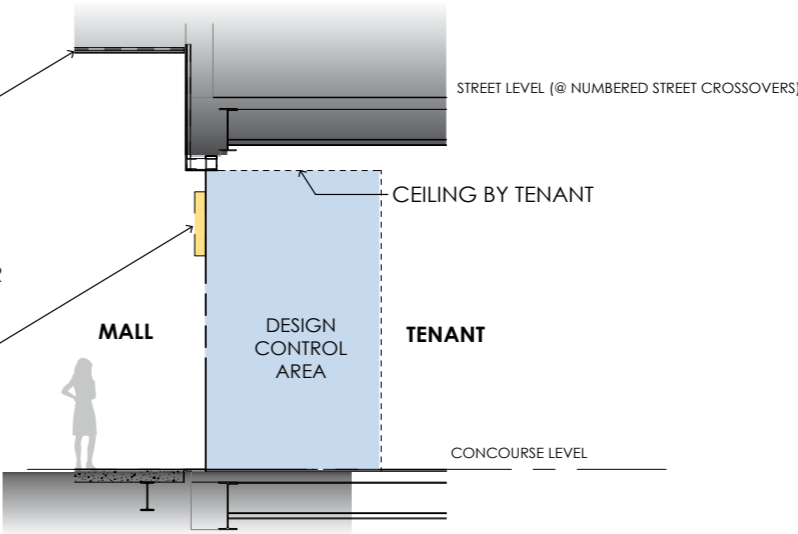
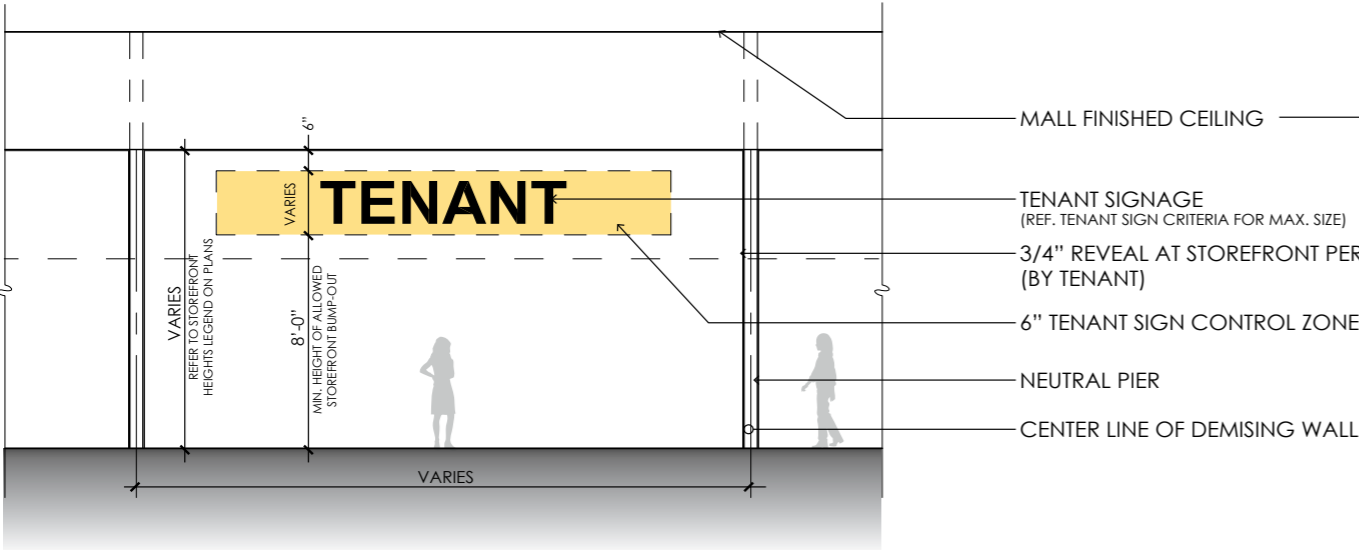

STOREFRONT ZONE 18 CRITERIA

1. TENANT SHALL MAXIMIZE CEILING HEIGHT WITHIN THEIR PREMISES.
2. TENANT IS RESPONSIBLE FOR VERIFYING ALL CONDITIONS IN FIELD.
3. TENANT ENTRY / PORTAL IS REQUIRED TO BE A MINIMUM OF 8'-0" IN HEIGHT.
4. DESIGN CONTROL ZONE TO EXTEND 8'-0" INTO TENANT PREMISES.
5. SIGNAGE SHALL NOT PROJECT BEYOND LEASE LINE UNLESS WITHIN TENANT CONTROL ZONE.

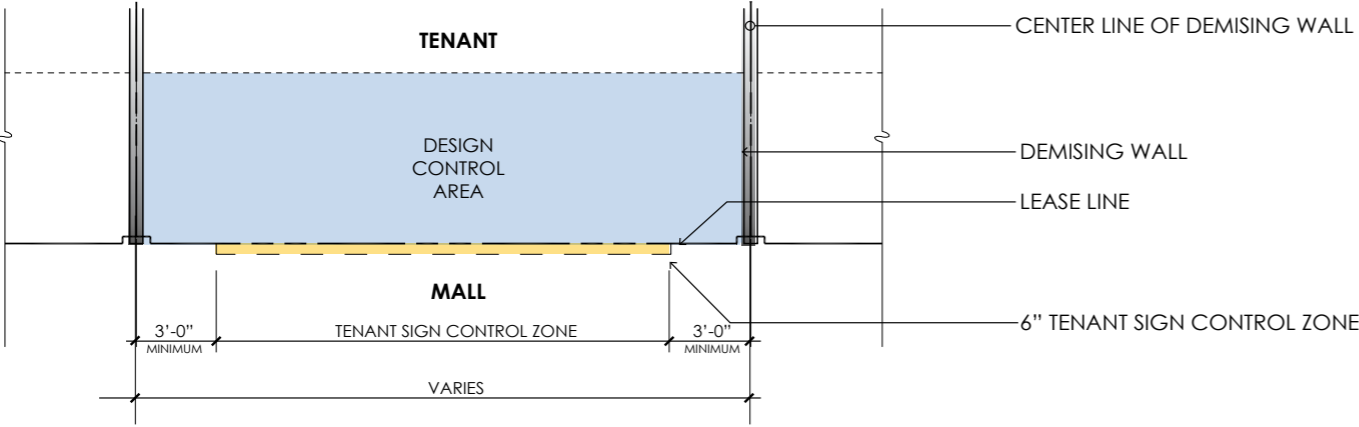

> ZONE DETAILS > ZONE 13

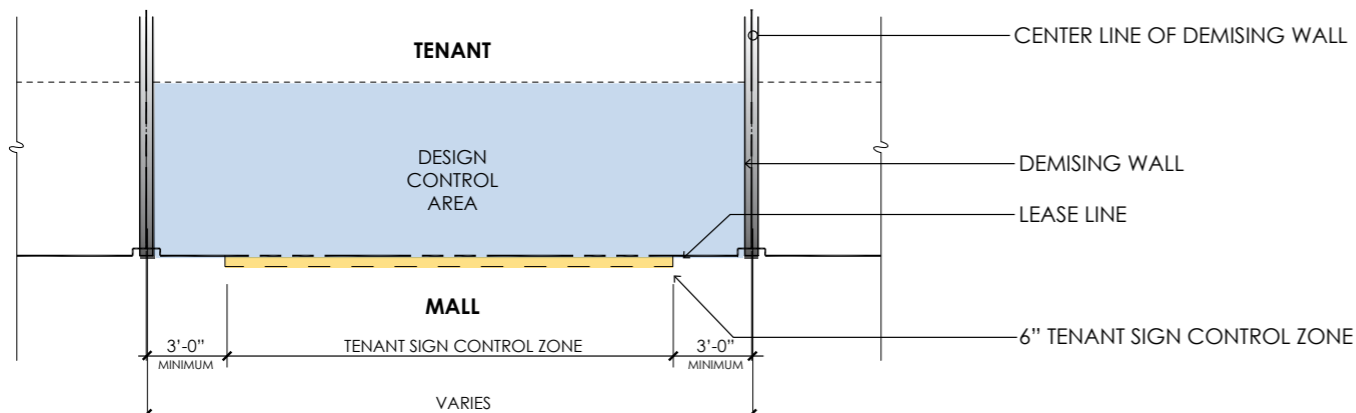
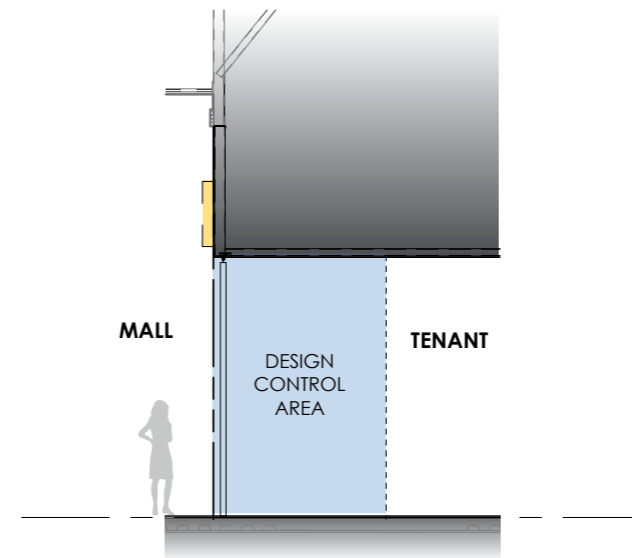
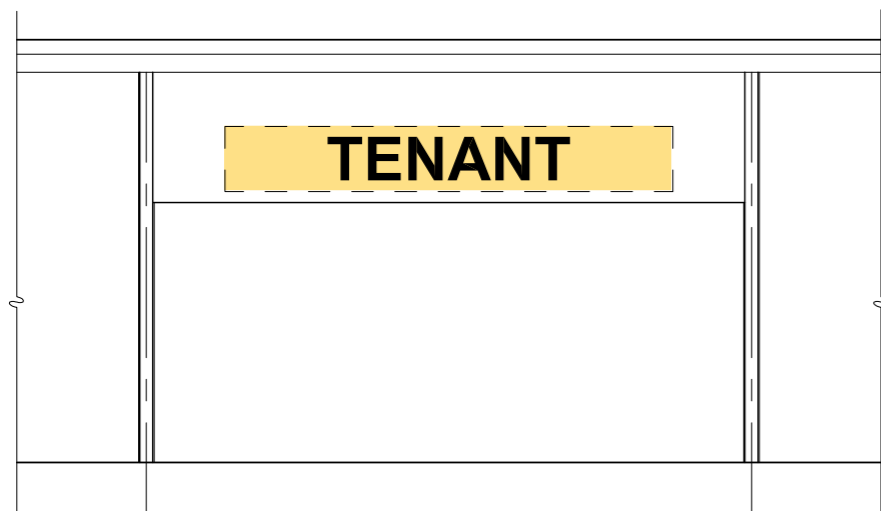
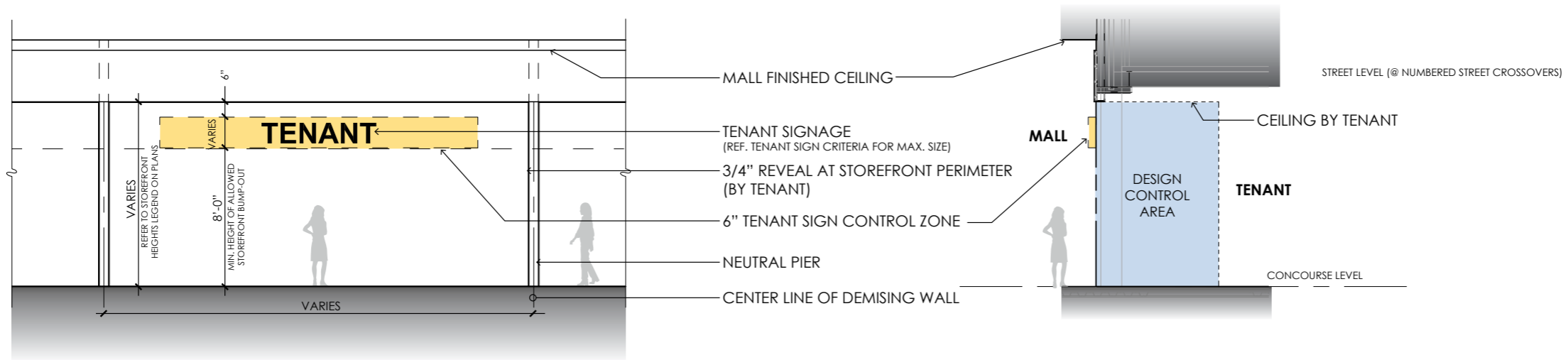

STOREFRONT ZONE 13A/B CRITERIA

1. TENANT SHALL MAXIMIZE CEILING HEIGHT WITHIN THEIR PREMISES.
2. TENANT IS RESPONSIBLE FOR VERIFYING ALL CONDITIONS IN FIELD.
3. TENANT ENTRY / PORTAL IS REQUIRED TO BE A MINIMUM OF 8'-0" IN HEIGHT.
4. DESIGN CONTROL ZONE TO EXTEND 8'-0" INTO TENANT PREMISES.
5. SIGNAGE SHALL NOT PROJECT BEYOND LEASE LINE UNLESS WITHIN TENANT CONTROL ZONE.

> ZONE DETAILS > ZONE 17

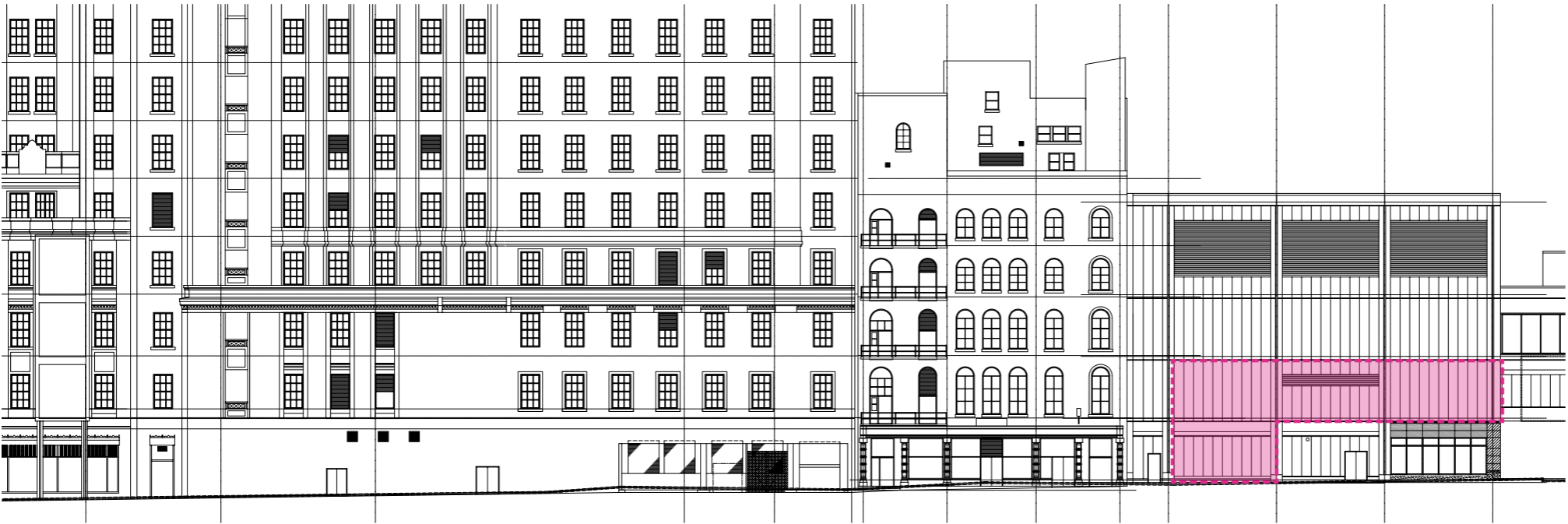

FILBERT STREET ELEVATION
STOREFRONT ZONE 17

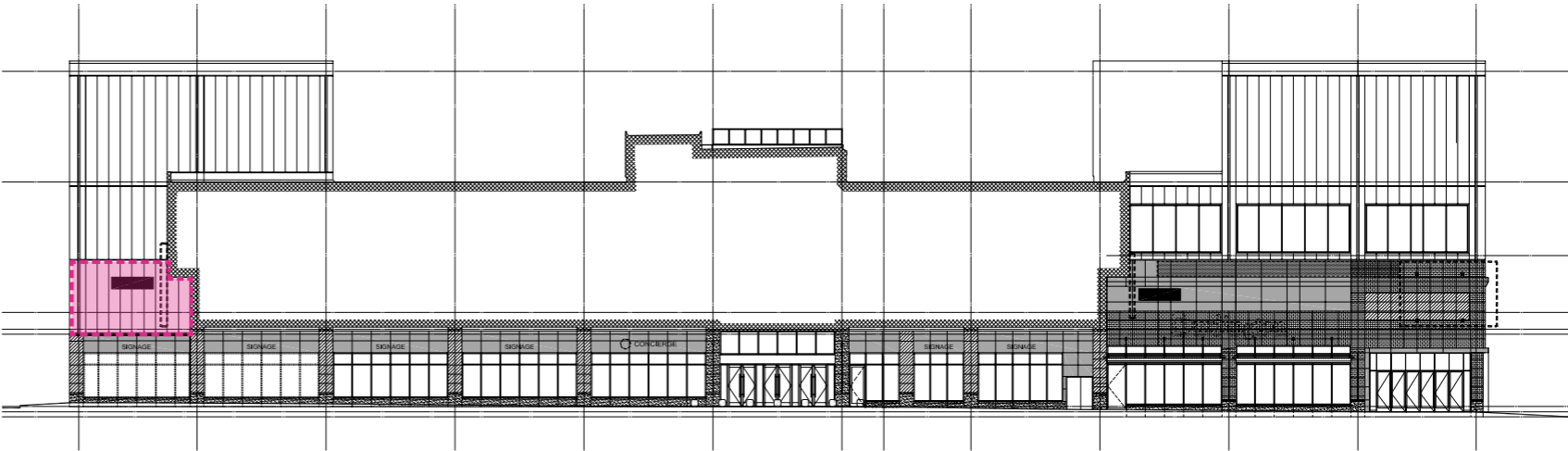

9TH STREET EAST ELEVATION

> ZONE DETAILS > ZONE 16 & 17

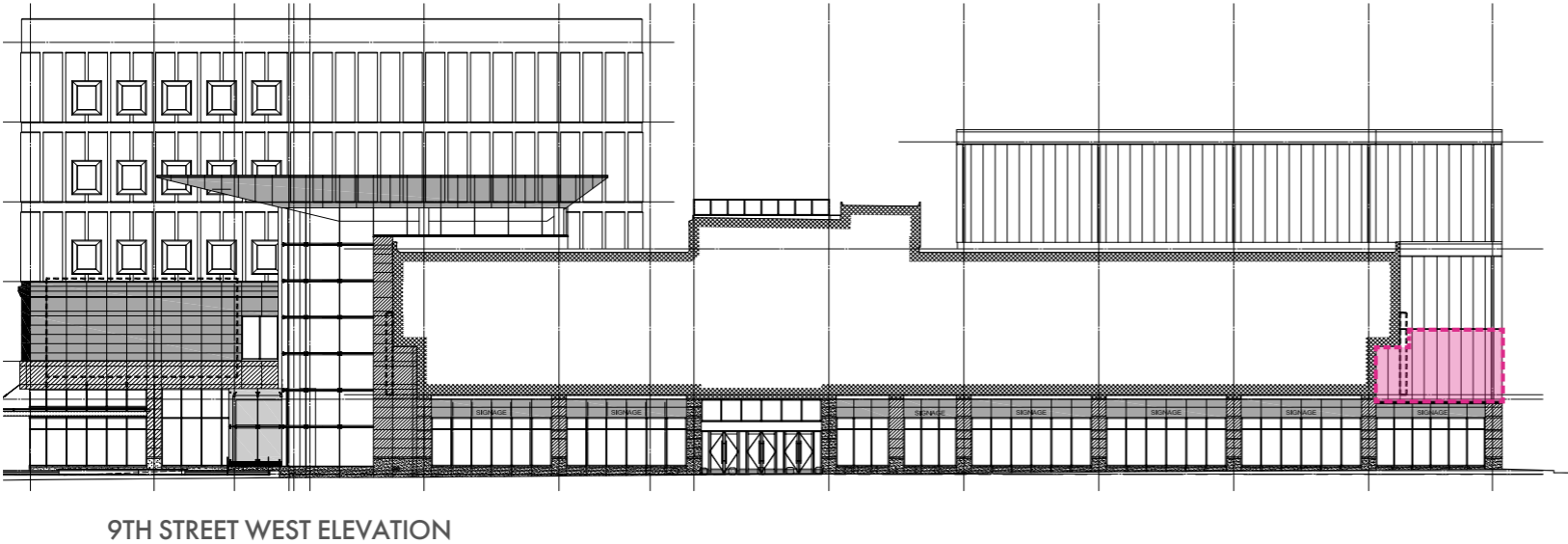
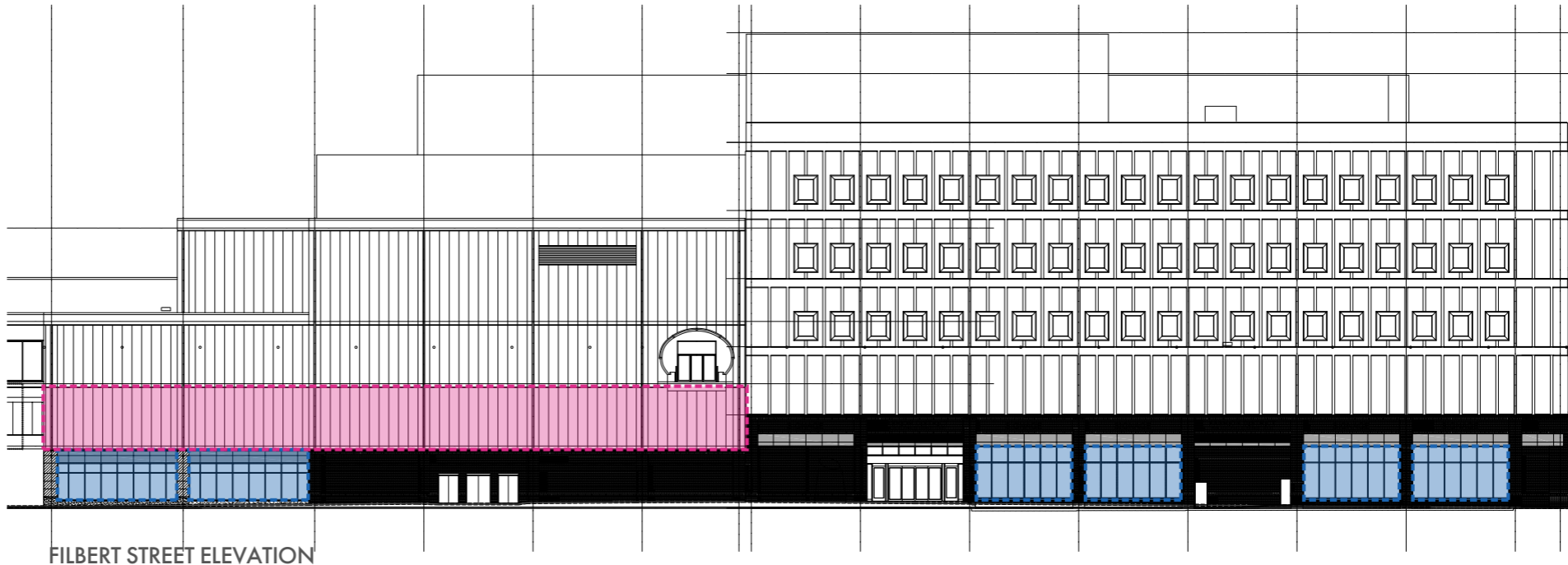

> ZONE DETAILS > ZONE 16 & 17

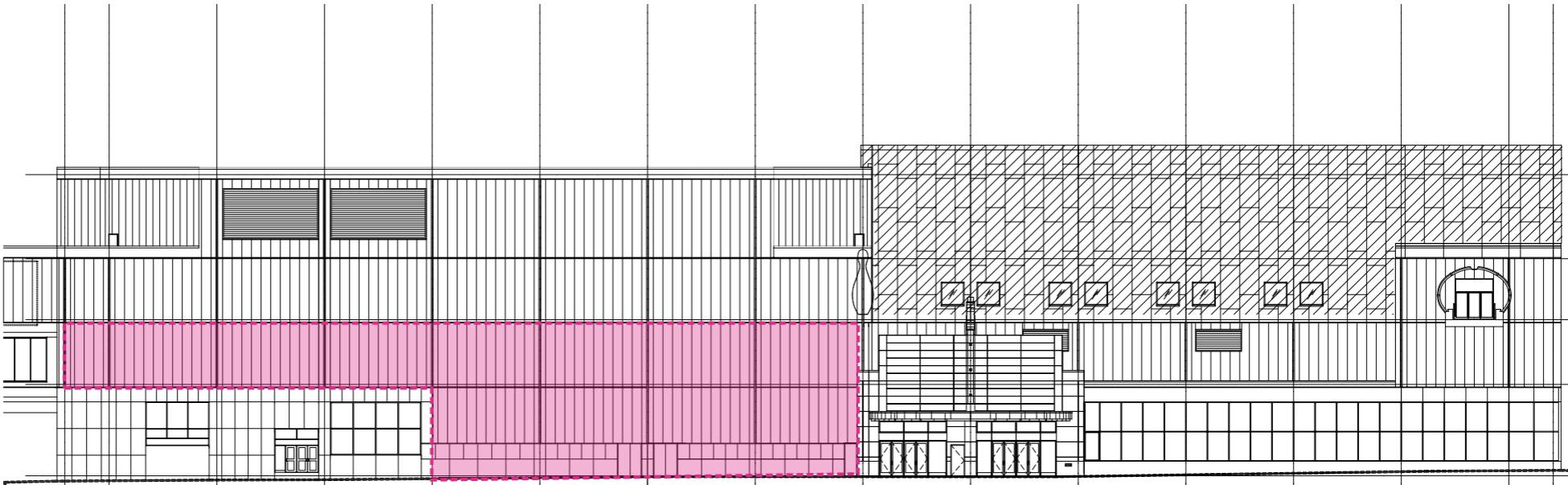

FILBERT STREET ELEVATION

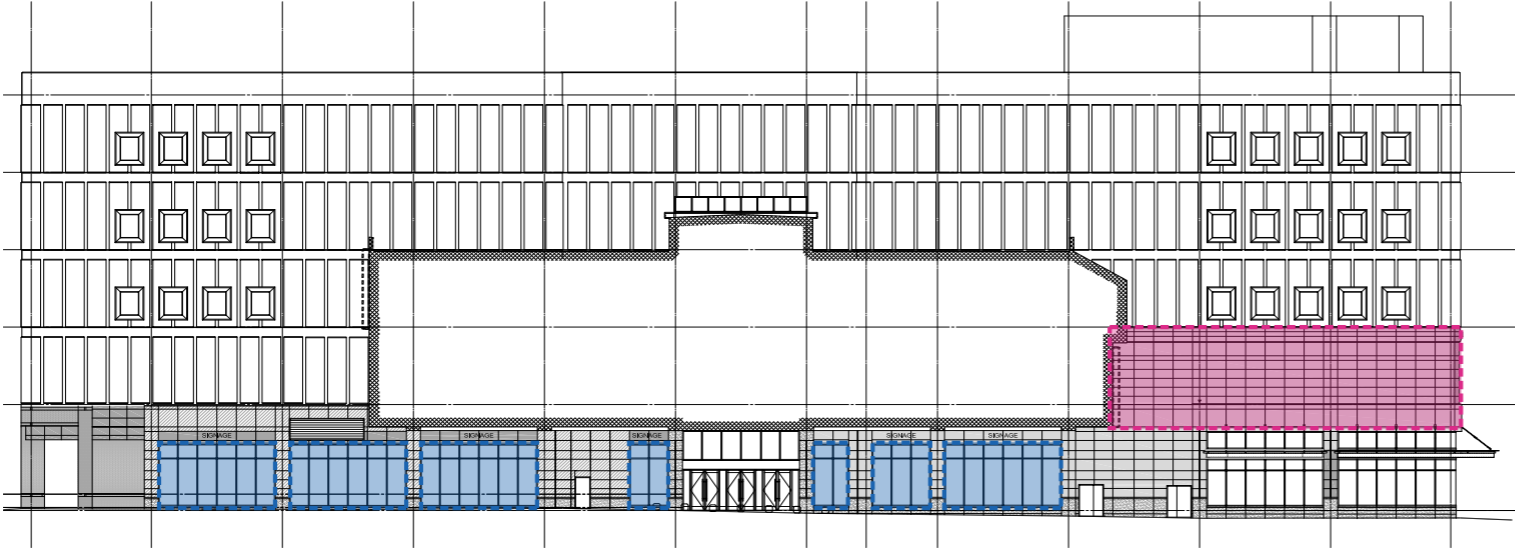

10TH STREET WEST ELEVATION

- STOREFRONT ZONE 16 ■■■
- STOREFRONT ZONE 17 ■■■

> ZONE DETAILS > ZONE 17

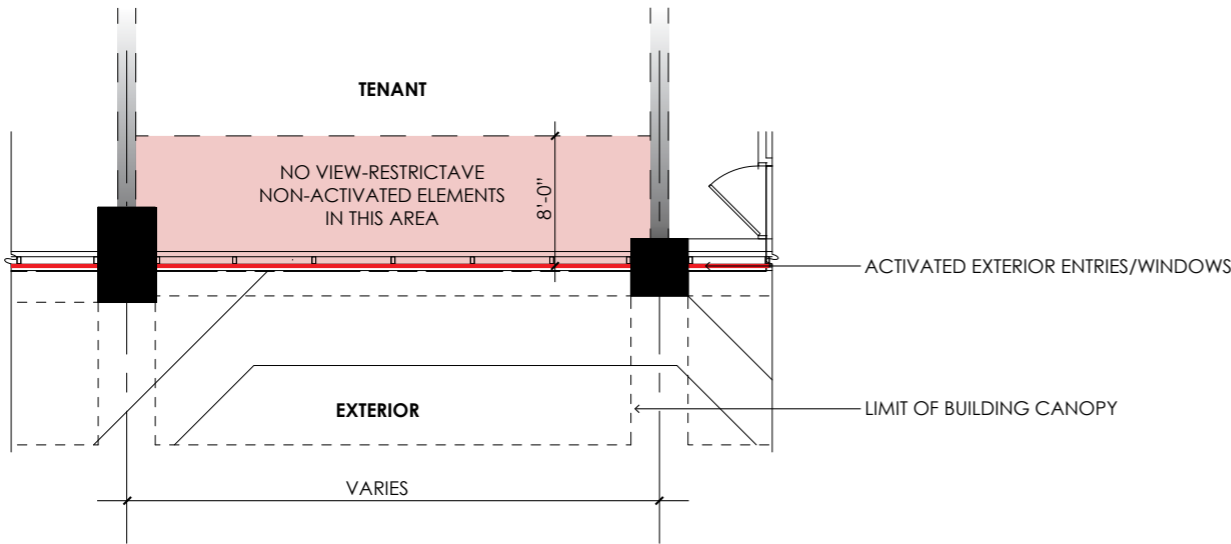
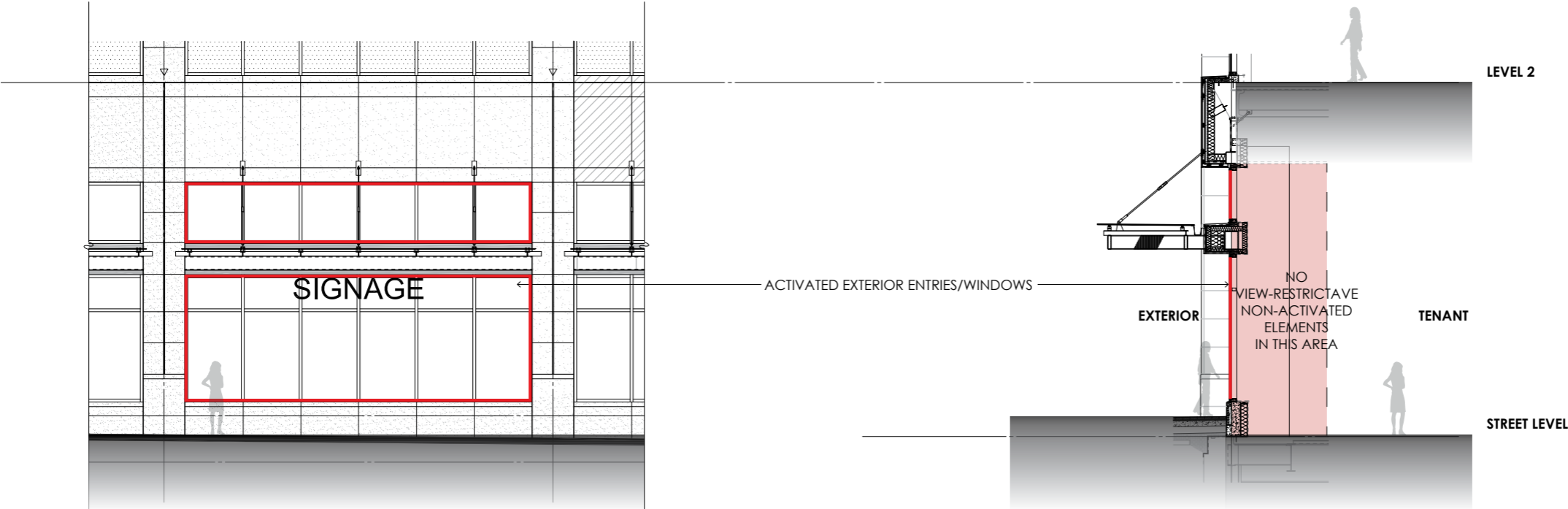

EXTERIOR STORE WINDOW CRITERIA - ZONE 17

1. TENANTS WITH EXTERIOR ENTRIES AND/OR STOREFRONT WINDOWS ARE REQUIRED TO ACTIVATE THESE SPACES WITH CURATED DISPLAYS, MERCHANDISE, CONCEPTUAL BRANDING & MEDIA TO PROVIDE VISUAL IDENTITY AND EXCITEMENT TO BOTH THEIR PREMISIS AND THE FASHION DISTRICT PHILADELPHIA OVERALL.
2. TENANTS CANNOT RESTRICT VIEWS INTO THEIR SPACE FROM STREET LEVEL OF THE EXTERIOR PUBLIC REALM BY ADDING NON-ACTIVATED WALLS, STORAGE ROOMS OR OTHER BACK OF HOUSE ELEMENTS WITHIN 8'-0" OF THE EXTERIOR GLAZING.
3. TENANTS CANNOT RESTRICT VIEWS INTO THEIR SPACE FROM THE SECOND LEVEL OF PUBLIC REALM BY ADDING NON-ACTIVATED WALLS, STORAGE ROOMS OR OTHER BACK OF HOUSE ELEMENTS WITHIN 3'-0" OF THE EXTERIOR GLAZING.
6. OWNERSHIP RESERVES THE RIGHT TO AMEND THESE REGULATIONS AS DEEMED NECESSARY WITHOUT PRIOR NOTICE.
7. TENANTS ARE REQUIRED TO CONSULT APPLICABLE PROJECT CRITERIA, PHILADELPHIA ORDINANCES AND BUILDING CODES.
8. WINDOW SIGNS SHOULD ALLOW FOR 60% OF OPEN GLASS / 20% GRAPHIC AREA IN THEIR DESIGN UNLESS APPROVED BY THE LANDLORD.
 - LEVEL 1: 20% OF WINDOW COVERAGE
 - LEVEL 2: 40% OF WINDOW COVERAGE

> ZONE DETAILS > ZONE 17

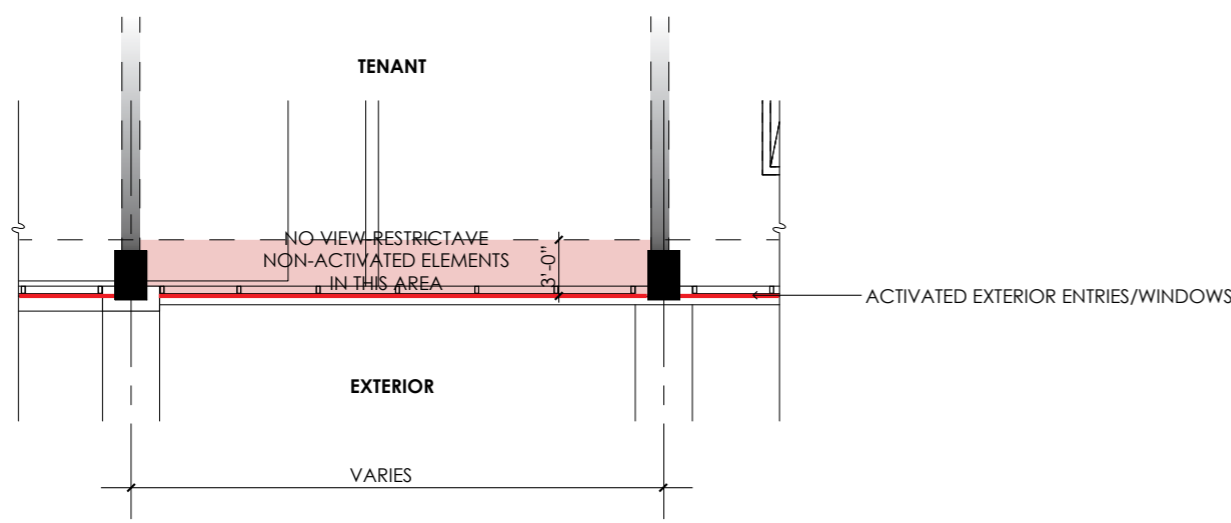
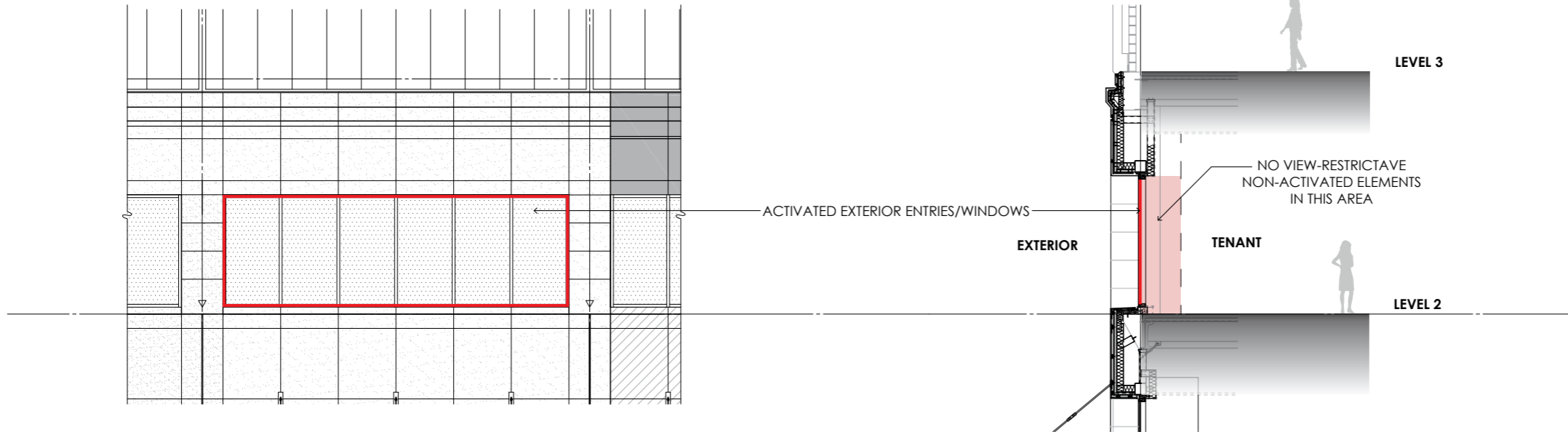

EXTERIOR STORE WINDOW CRITERIA - ZONE 17

1. TENANTS WITH EXTERIOR ENTRIES AND/OR STOREFRONT WINDOWS ARE REQUIRED TO ACTIVATE THESE SPACES WITH CURATED DISPLAYS, MERCHANDISE, CONCEPTUAL BRANDING & MEDIA TO PROVIDE VISUAL IDENTITY AND EXCITEMENT TO BOTH THEIR PREMISES AND THE FASHION DISTRICT PHILADELPHIA OVERALL.
2. TENANTS CANNOT RESTRICT VIEWS INTO THEIR SPACE FROM STREET LEVEL OF THE EXTERIOR PUBLIC REALM BY ADDING NON-ACTIVATED WALLS, STORAGE ROOMS OR OTHER BACK OF HOUSE ELEMENTS WITHIN 8'-0" OF THE EXTERIOR GLAZING.
3. TENANTS CANNOT RESTRICT VIEWS INTO THEIR SPACE FROM THE SECOND LEVEL OF PUBLIC REALM BY ADDING NON-ACTIVATED WALLS, STORAGE ROOMS OR OTHER BACK OF HOUSE ELEMENTS WITHIN 3'-0" OF THE EXTERIOR GLAZING.
6. OWNERSHIP RESERVES THE RIGHT TO AMEND THESE REGULATIONS AS DEEMED NECESSARY WITHOUT PRIOR NOTICE.
7. TENANTS ARE REQUIRED TO CONSULT APPLICABLE PROJECT CRITERIA, PHILADELPHIA ORDINANCES AND BUILDING CODES.
8. WINDOW SIGNS SHOULD ALLOW FOR 60% OF OPEN GLASS / 20% GRAPHIC AREA IN THEIR DESIGN UNLESS APPROVED BY THE LANDLORD.
 - LEVEL 1: 20% OF WINDOW COVERAGE
 - LEVEL 2: 40% OF WINDOW COVERAGE

> NEUTRAL PIER > DETAILS A-D

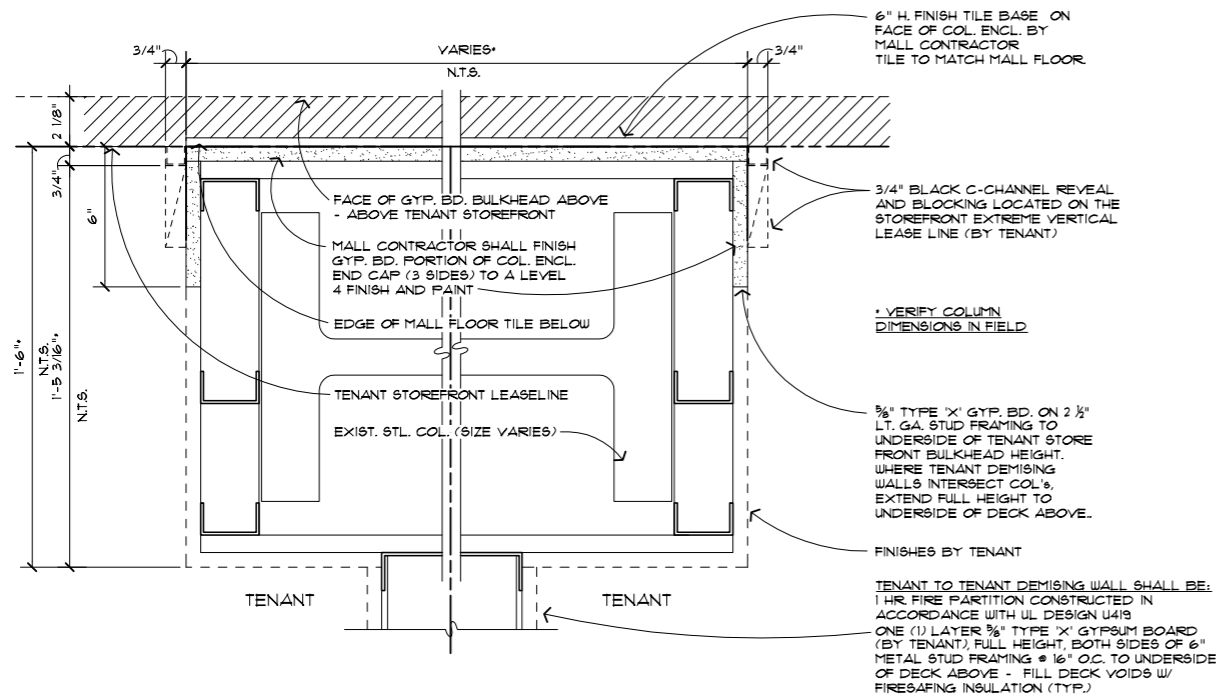

DETAIL A

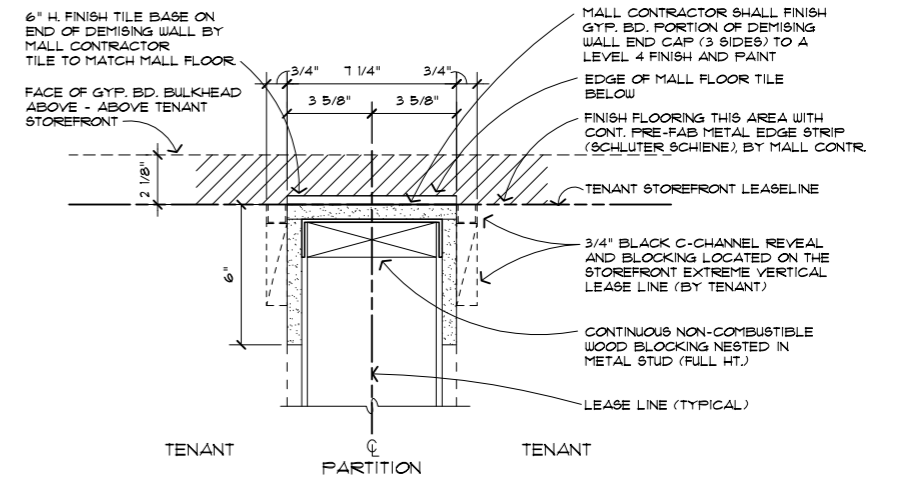

TENANT TO TENANT DEMISING WALL SHALL BE: 1 HR. FIRE PARTITION CONSTRUCTED IN ACCORDANCE WITH UL DESIGN U419 ONE (1) LAYER 3/8" TYPE 'X' GYPSUM BOARD (BY TENANT), FULL HEIGHT, BOTH SIDES OF 6" METAL STUD FRAMING @ 16" O.C. TO UNDERSIDE OF DECK ABOVE - FILL DECK VOIDS W/ FIRESAFING INSULATION (TYP.)

DETAIL B

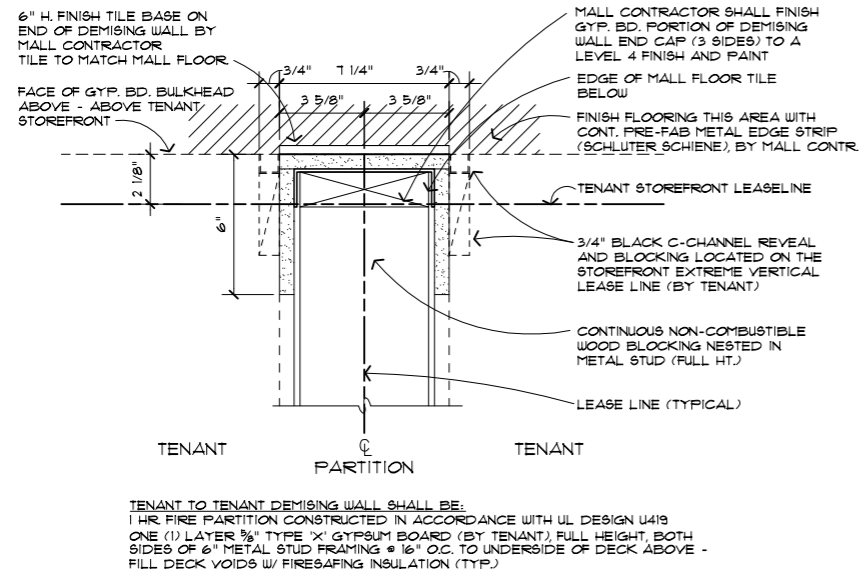

DETAIL C

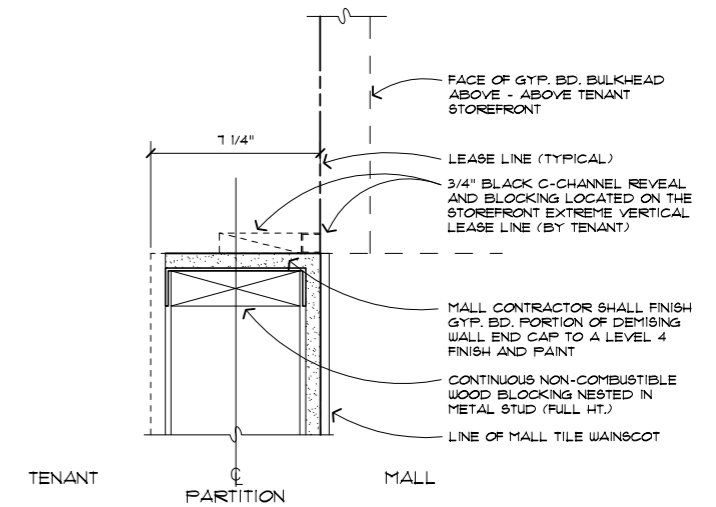

DETAIL D

> EXPANSION JOINT > DETAILS

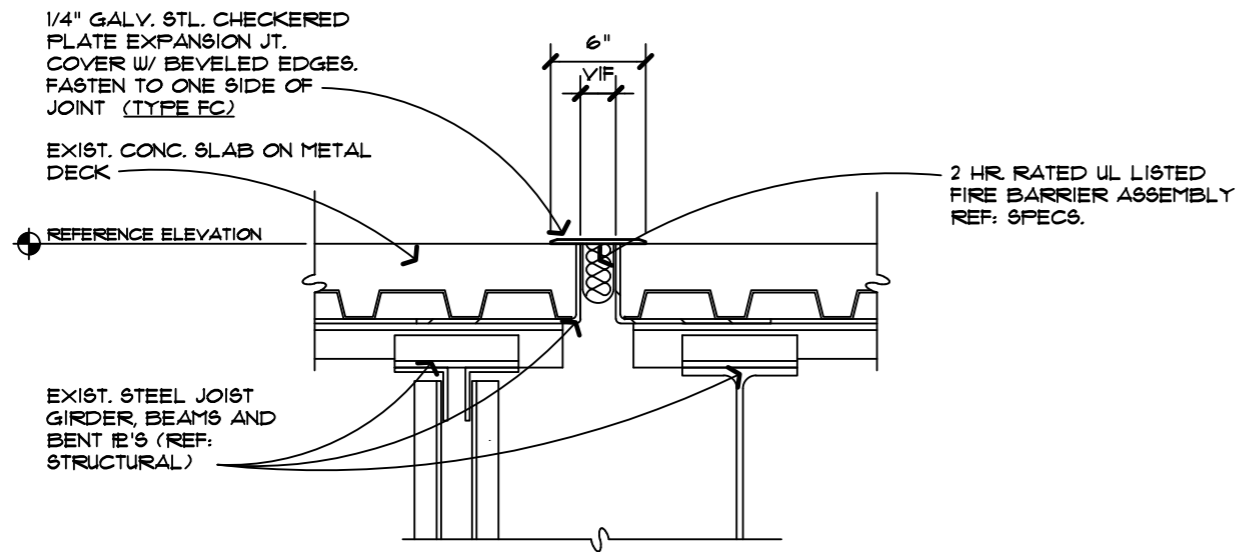

TYP. DETAIL @ EXIT PASSAGEWAY / SERVICE CORRIDOR INLINE EXP. JT.

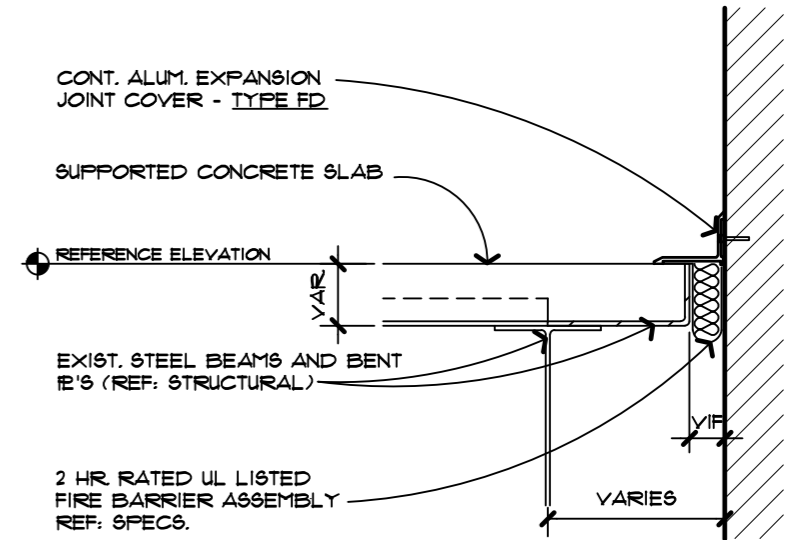

TYP. DETAIL @ EXIT PASSAGEWAY / SERVICE CORRIDOR FLOOR / WALL EXP. JT.

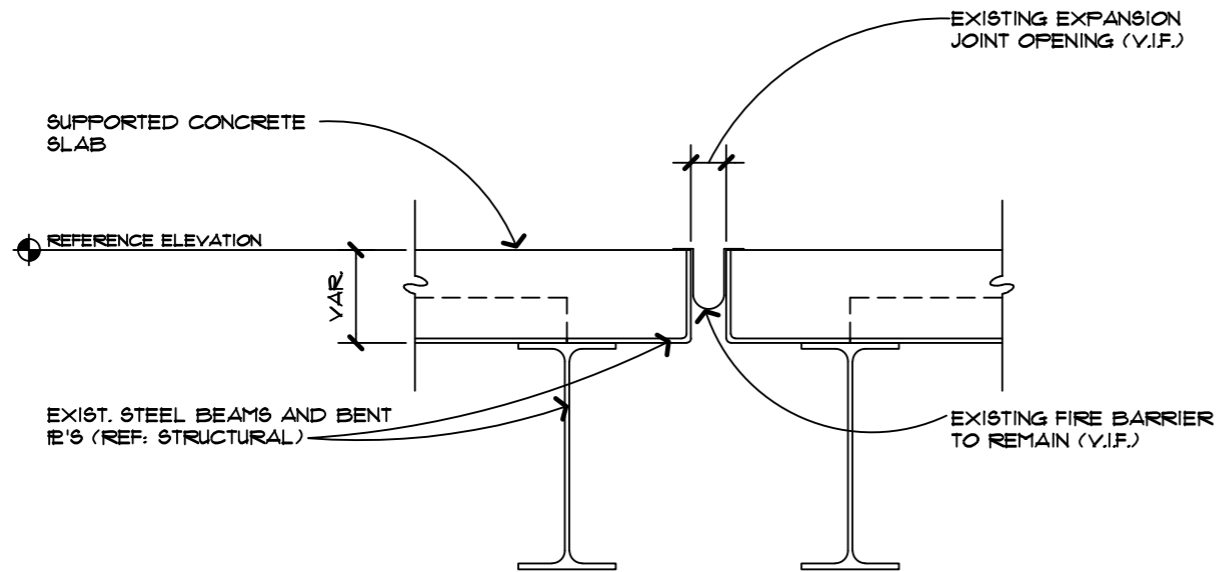

TYP. DETAIL AT TENANT SPACE EXP. JOINT

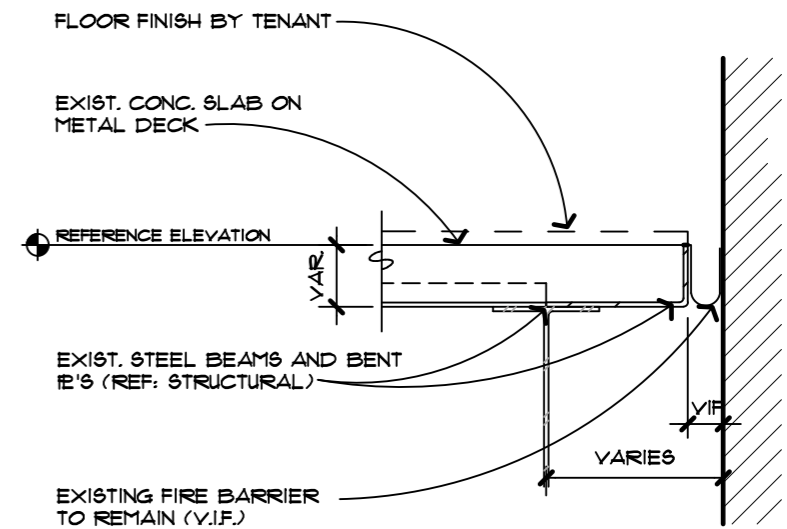

TYP. DETAIL AT TENANT SPACE EXP. JOINT

> DETAILS

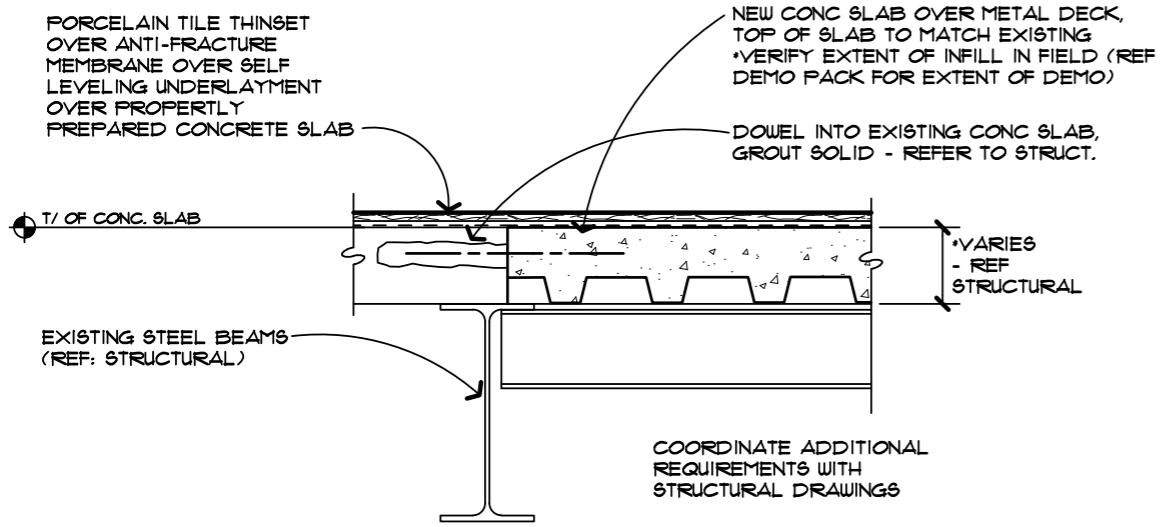

TYPICAL INFILL DETAIL @ SUPPORTED SLAB FLOOR OPENING

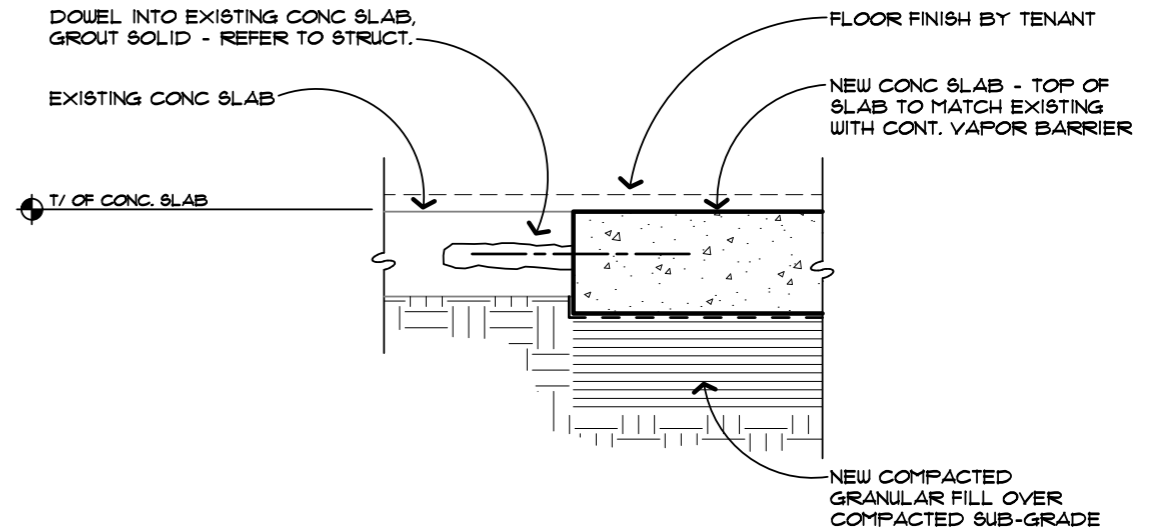

TYP. TRANSITION @ NEW TO EXISTING SLAB ON GRADE - TENANT AREAS

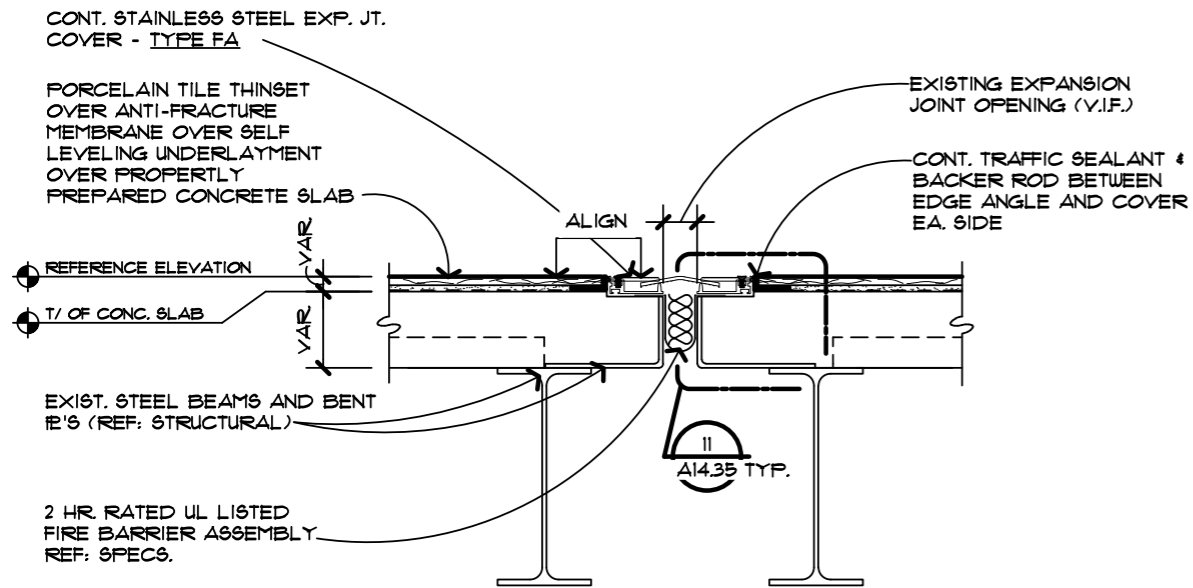

TYPICAL DETAIL @ MALL CONCOURSE INLINE EXP. JT. COVER

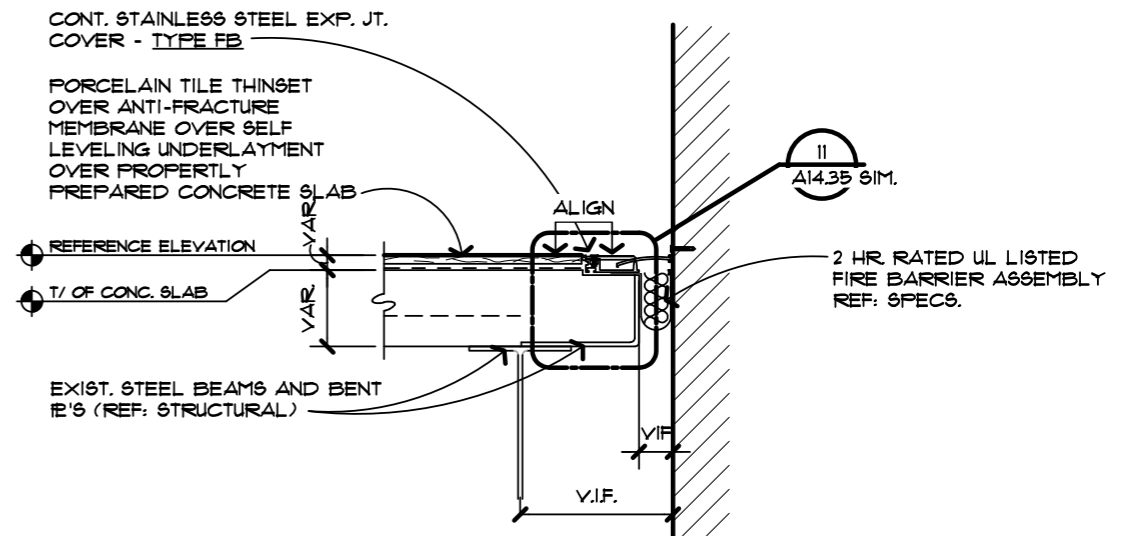

TYP. DETAIL @ MALL CONCOURSE FLOOR TO WALL EXP. JT. COVER

> DETAILS

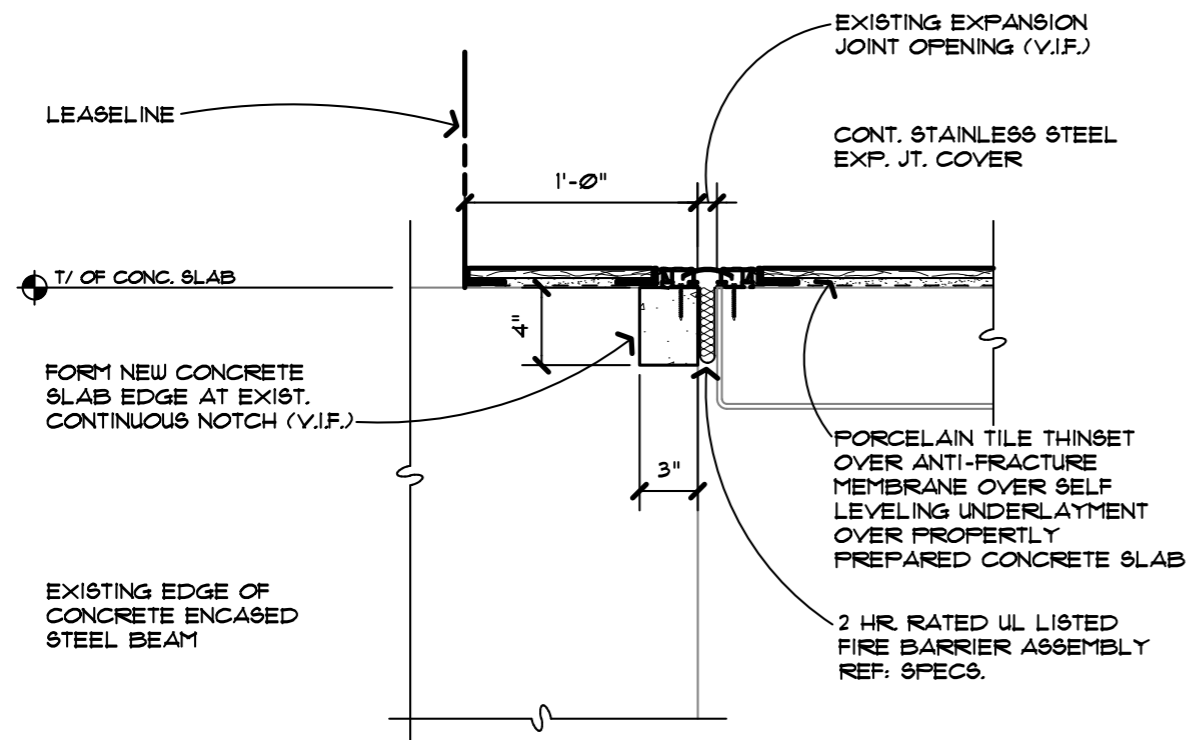

○ TYP. DETAIL AT EXIST. EXPANSION JOINT

DESIGN INSPIRATION CONTENT OVERVIEW

4.1

VISUAL CONCEPTS

GUIDE TO DIFFERENT AESTHETIC CONCEPT ENCOURAGING VIBRANT STORE DESIGNS.

4.2

KEY DESIGN ELEMENTS

OVERVIEW OF THE CORE DESIGN ELEMENTS TO EMBRACE WHEN CREATING AN ENLIVENING RETAIL EXPERIENCE.

The vibrant character of great shopping destinations is comprised of exceptional storefronts with texture, color, lighting, graphics and merchandising enlivening the pedestrian experience.

Tenants are encouraged to express their individuality and their brand identity through excellent design by forward thinking design teams.



VISUAL CONCEPTS > OVERVIEW

- ARTISAN
- URBAN
- WHIMSICAL
- INVITING
- ARTSY
- THEATRICAL

This section highlights six design concepts encouraged by Macerich for Tenant's looking for additional store design inspiration. Our design team welcomes Tenants to engage in these concepts and invites open collaboration in an effort to create store designs that enhance the retail experience.

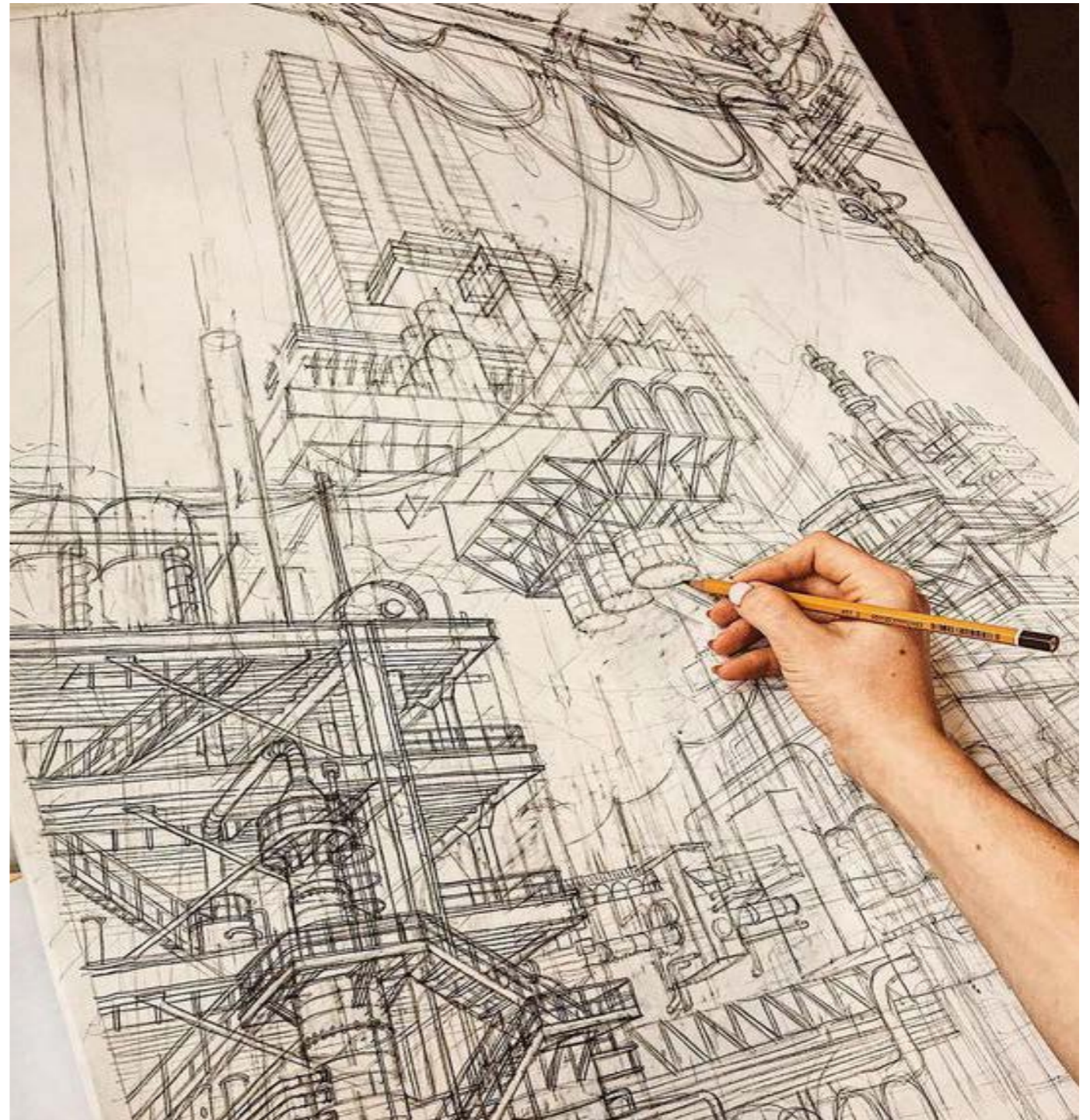

> ARTISAN

ARTISAN

NATURAL, SOPHISTICATED, UNIQUE



> URBAN

URBAN

EDGY, FUNKY, STREET SAVVY STYLE, INDUSTRIAL

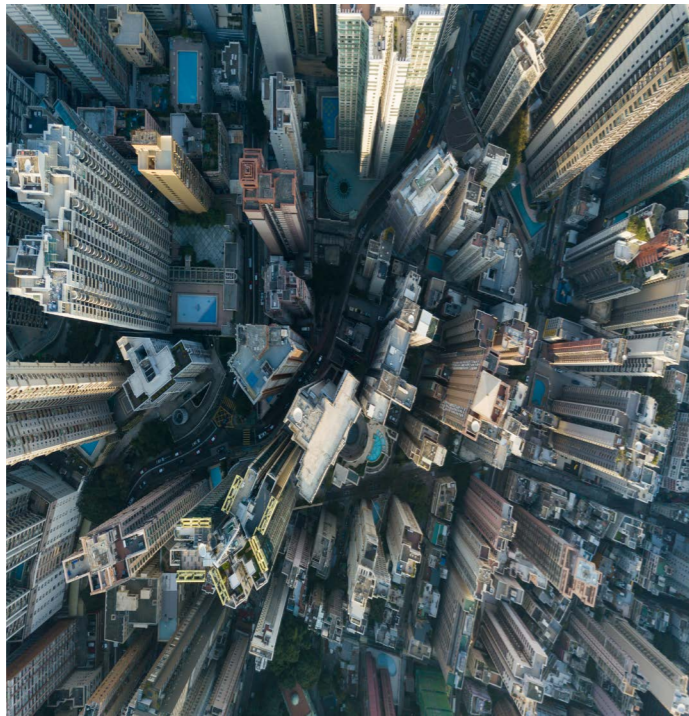

> WHIMSICAL

WHIMSICAL

UNEXPECTED, PLAYFUL, COLORFUL



> INVITING

INVITING
WARM, CALM, OPEN, SOFT



> ARTSY

ARTSY

QUIRKY, AVANT GARDE, SURPRISING



> THEATRICAL

T H E A T R I C A L
DRAMATIC, HIGH CONTRAST, MOVEMENT



KEY DESIGN ELEMENTS > BRANDING / VISUAL MERCHANDISING

Macerich embraces four key design elements to engage Customers and encourage Store traffic and sales. Strong use of textures, colors, lighting, graphics, and merchandising in these elements help draw Customers and invliven the pedestrian experience.

BRANDING

A brand is a name, term, design, symbol, color or some other feature that identifies a seller's product or services as distinct from those of other seller's.

Your branding can be communicated with signage, graphics, materials, shapes, colors, textures, patterns and the overall look and feel of your kiosk, to tell a story and create a lasting experience.



VISUAL MERCHANDISING

Strong visual presentation and merchandising are essential and integral components of retail design.

- Attempt to create triangular composition within style groups or color groups. (display in groups of three or five).
- Start with a center feature, (best sellers and hot items), and merchandise out symmetrically or asymmetrically in a balanced manner.



> LAYERING / TECH AND MEDIA

LAYERING

How can you make a wall / elevation into a canvas for communication to the customer as they walk towards or by your store?

- Incorporating patterns and textures.
- Overlaying materials to create dimensionality.
- Molding shapes to create softness.
- Overlapping to create shadows and depth.



TECHNOLOGY AND MEDIA

Technology can enhance your on line operation by transforming your retail space into a multifunctional one, that lends itself to being an in store pick up location, payment booth or advertising billboard.

Integrating technology into your store design can:

- Become an extension of you.
- Supplement your salesforce with interactive screens for ordering, design yourself functions and more.
- Keep your business connected with your customer.
- Help you tell a story.
- Help make menu boards easier to update and better communicate your offerings to your customer via LCD screen loops.

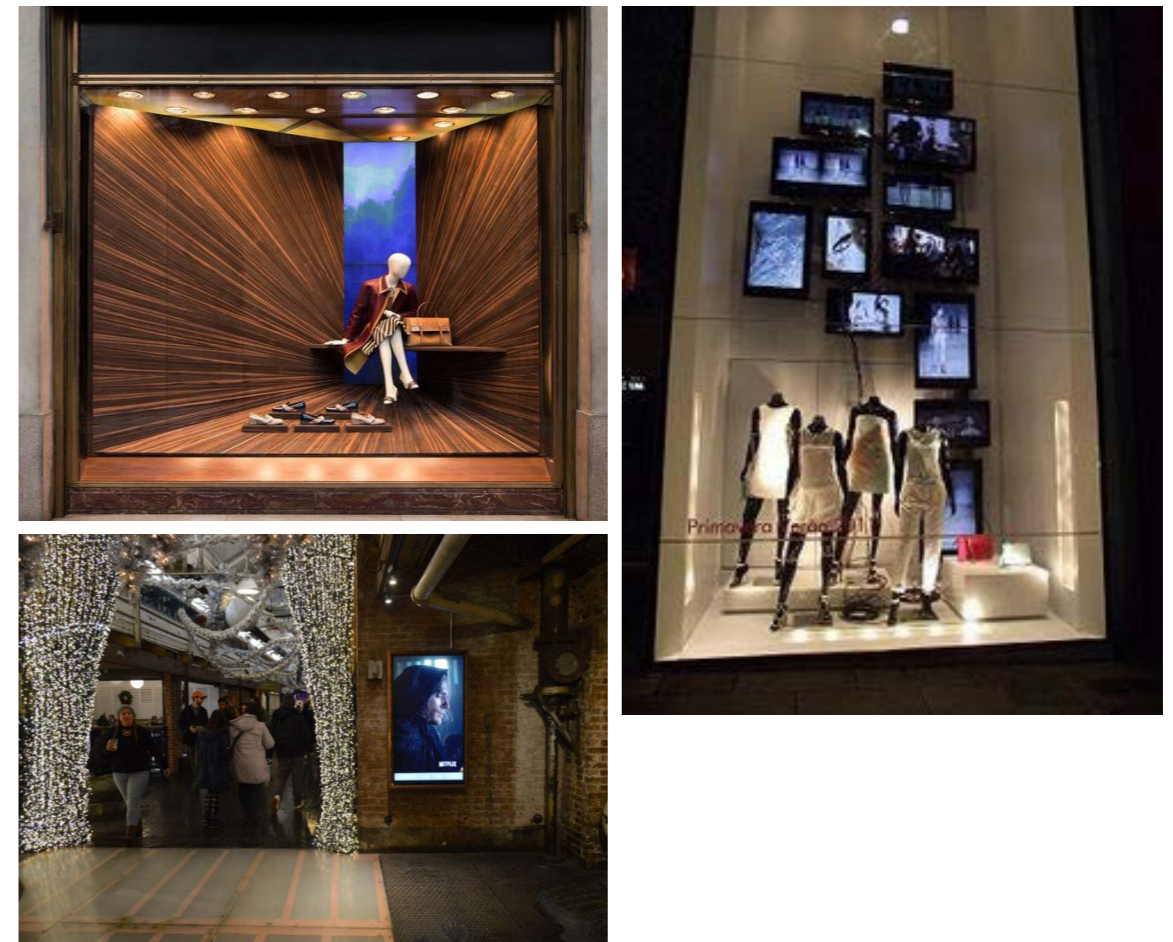

PROPERTY INFO CONTENT OVERVIEW

5.1 ADDRESS & HOURS

LOCATION AND SCHEDULE INFO.

5.2 SITE PLAN

OVERVIEW MAP OF CENTER.

5.3 CONTACTS

MALL CONTACTS, REQUIRED CONTRACTORS, LOCAL MUNICIPALITIES, AND UTILITY CONTACT INFO.

5.4 CODES AND PERMITTING

OVERVIEW OF BUILDING CODE, CLASSIFICATIONS, AND LOCAL PERMITTING.

5.5 OPERATIONS AND UTILITIES

OVERVIEW OF CENTER OPERATIONS AND TYPICALLY AVAILABLE UTILITIES.

5.6 CONSTRUCTION

OVERVIEW OF CONSTRUCTION PROCEDURES.

SECTIONS OF INTEREST

The following sections provide additional details and requirements related to this Criteria:

ADDENDUM

Provides additional construction requirements to contractors.

The Property Info Criteria provides an overview of the Center’s building classification, contacts, local permitting, and typically provided utilities.

It is important to note that the Contacts section includes the Center’s required contractors. These contractors **must** be used during the design and buildout of your Store.



ADDRESS AND HOURS

Fashion District Philadelphia is centrally located in downtown Philadelphia, spanning three City blocks from 8th Street to 11th Street between Market and Filbert Street.

Center Address

901 Market Street
Philadelphia, PA 19107

Center Hours

Monday - Saturday: 10:00 AM to 8:00 PM
Sunday: 11:00 AM to 6:00 PM

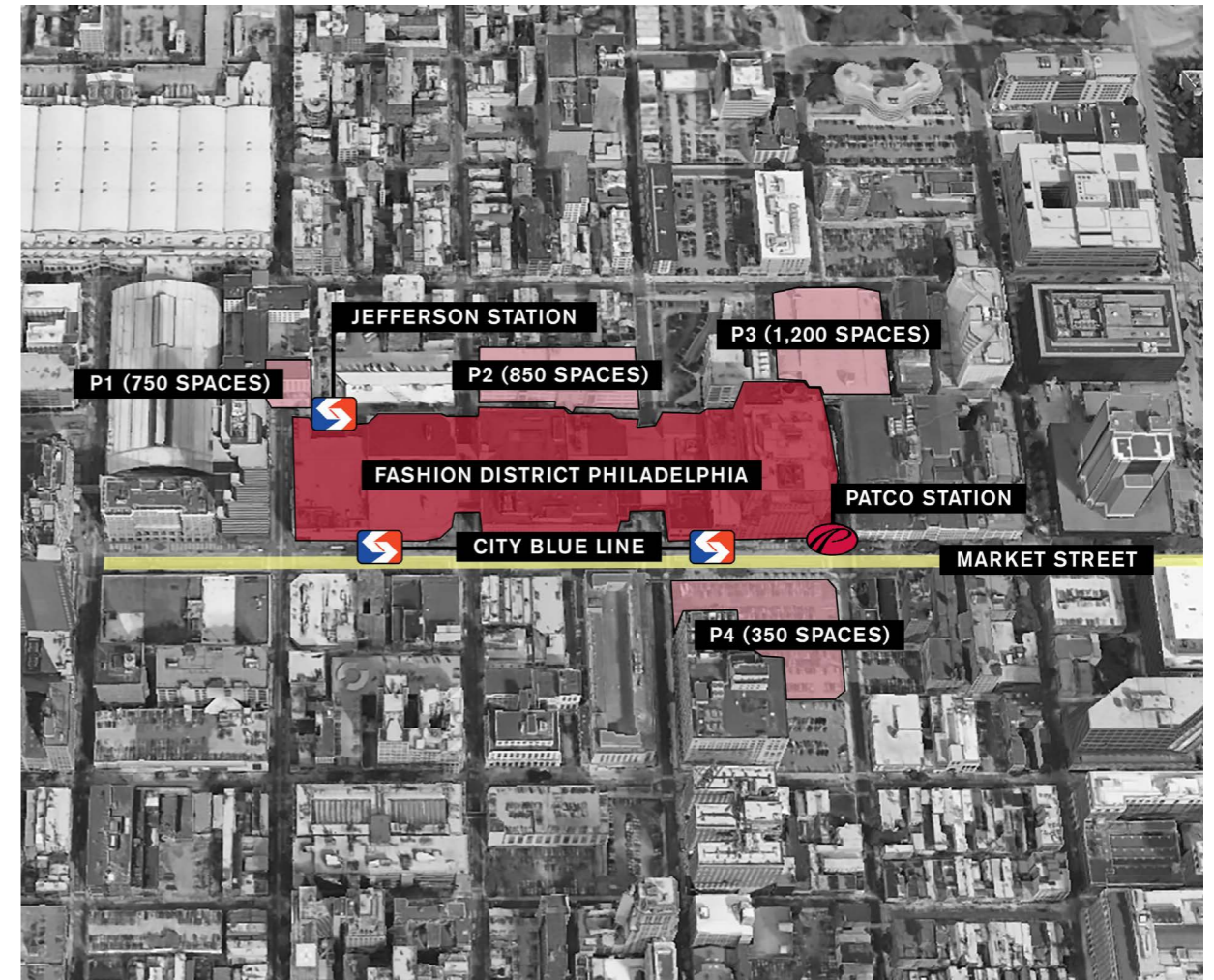

> SECOND LEVEL

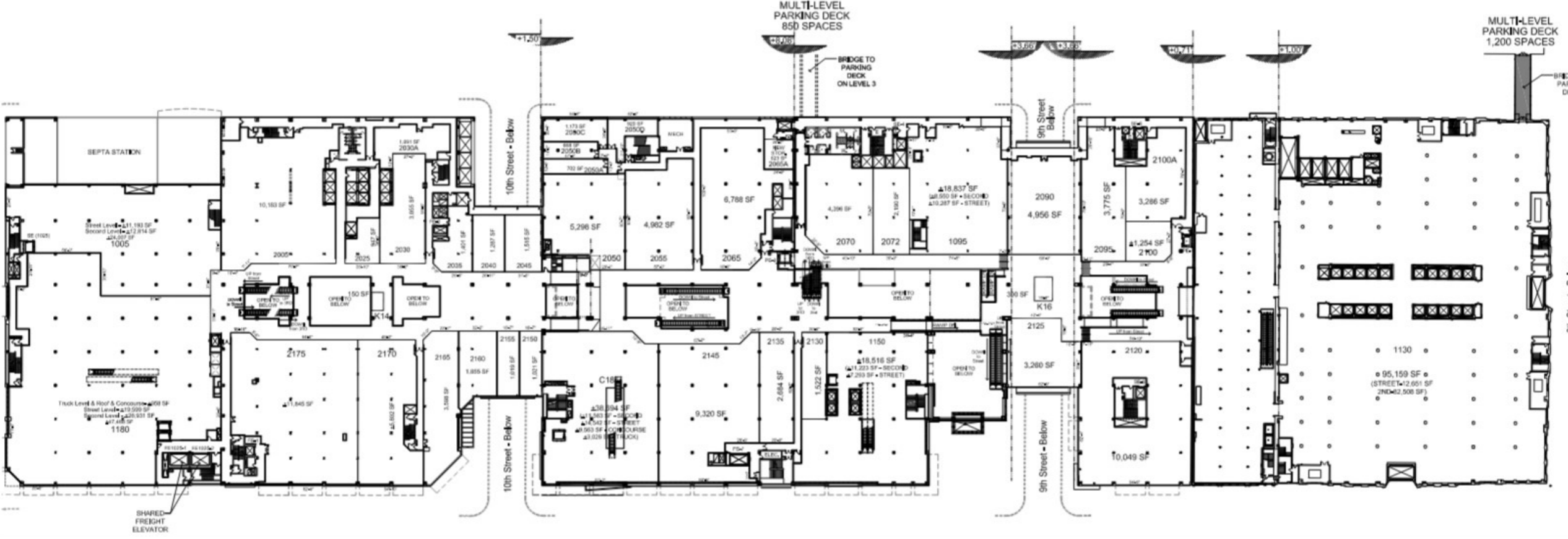

SECOND LEVEL

> THIRD LEVEL

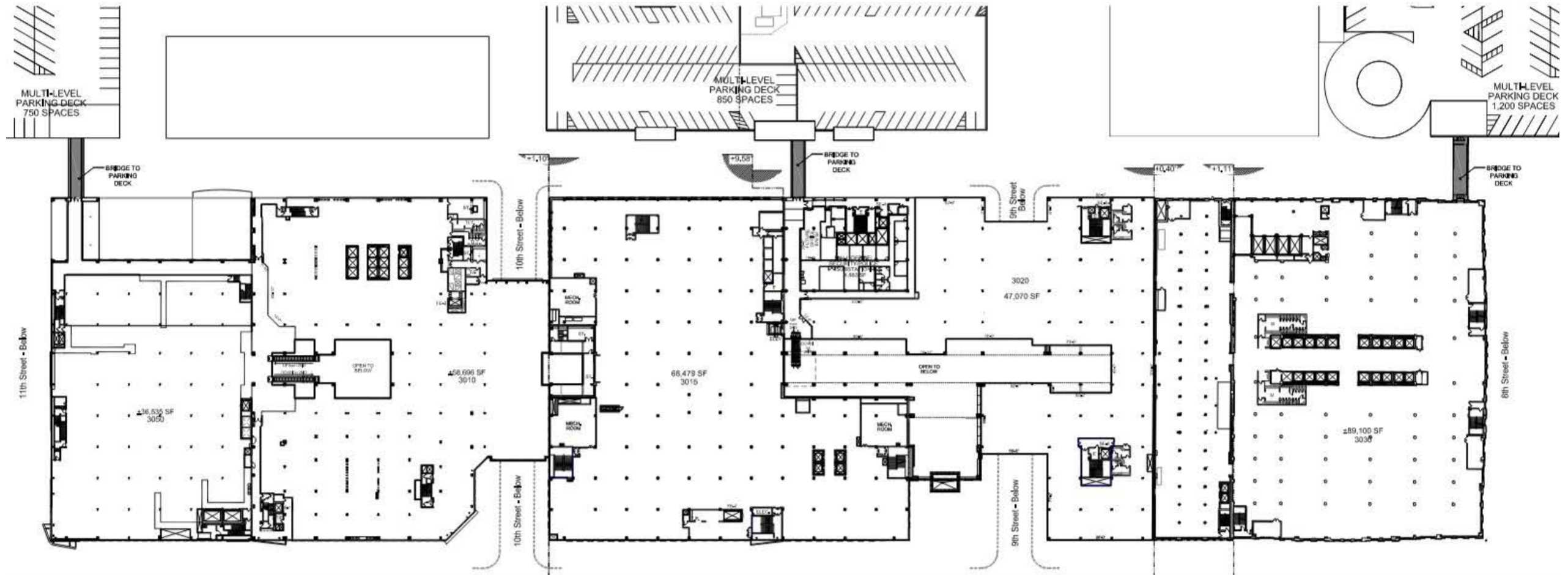

THIRD LEVEL

> PROPERTY TEAM / REQUIRED CONTRACTORS

PROPERTY TEAM

The following points of contacts are available to discuss site details and procedures. The primary point of contact for inquiries is the Tenant Coordinator.

TENANT COORDINATION

Greg Wojcik

Phone: (585) 739-1889

greg.wojcik@macerich.com

OPERATIONS GENERAL MANAGER

Ryan Williams

Phone: (267) 534-7705

ryan.williams@macerich.com

OPERATIONS DIRECTOR

Daniel Lauler

Phone: (856) 261-2452

daniel.lauler@macerich.com

LEASING

Teri Furry

Phone: (703) 847-7322

teri.furry@macerich.com

LANDLORD/OWNER

The MACERICH Company

401 Wilshire Blvd., Suite 700

Santa Monica, CA 90401

REQUIRED CONTRACTORS

The following points of contacts are the required contractors that must perform the construction for their related systems. These contractors are required since they have intimate knowledge of the property building systems and can properly interface Tenant systems with the base building infrastructure.

SPRINKLER CONTRACTOR

A&S Sprinkler

Tom Stefanelli

Phone: (215) 379-2900

tms@as-sprinkler.com

ELECTRICAL TIE-IN CONTRACTOR

ARMOUR & SONS

Bill Boynton

Phone: (215) 669-1034

Bboynton@armourandsons.com

DATA PROVIDER

GRANITE GRID

Rob Norton

Phone: (781) 884-5545

rnorton@granitenet.com

HVAC CONTROLS CONTRACTOR

AUTOMATED BUILDING CONTROLS

Darrel Golden

3320 Route 66

Neptune, NJ 07753

Phone: (732) 918-8958

dgolden@automatedbuilding.com

FIRE ALARM CONTRACTOR

SIEMENS

Mike Pottorff

Phone: (609) 548-8045

michael.pottorff@siemens.com

ROOFING CONTRACTOR

UNITED STATES ROOFING CORPORATION

Phone: (610) 272-6600

BARRICADES

Boston Barricade

Mid Atlantic Local Team

Chris Danielson (GM)

Phone: (77) 257-7144

cdanielson@bostonrs.com

> UTILITIES / LOCAL AGENCIES / BASE BUILDING DESIGN

UTILITIES

The following points of contacts are the utility companies necessary to interface with to set up utility accounts:

DATA

*Data is required to be set up through Granite Grid. Other service providers do not have a Right of Entry agreement and are not permitted. ****It is highly recommended to coordinate service install a minimum of 4 weeks in advance***

Granite Grid

Rob Norton

Phone: (781) 884-5545

rnorton@granitenet.com

GAS

Gas utility is only available for food use. Gas is not available for heating.

Philadelphia Gas

1601 S Broad Street

Philadelphia, PA 19102

Phone: (215) 235-1212

LOCAL AGENCIES

The following points of contacts are the local agencies responsible for plan reviews and inspections:

LICENSE AND INSPECTIONS

Responsible for business licensing, building permits, plan review, site inspections, and Certificate of Occupancy.

Municipal Services Building – 11th Floor

1401 John F. Kennedy Boulevard

Philadelphia, PA 19102

Phone: (215) 686-2400

HEALTH DEPARTMENT

Responsible for health inspections.

321 University Avenue, 2nd Floor

Philadelphia, PA 19104

Phone: (215) 685-7495

STREETS DEPARTMENT

Responsible for permitting street closures, coordinating exterior improvements to seating areas, signage, and sidewalks.

940 Municipal Services Building

1401 John F. Kennedy Boulevard

Philadelphia, PA 19102

Phone: (215) 686-5501

FIRE DEPARTMENT

240 Spring Garden Street

Philadelphia, PA 19102

Phone: (215) 686-1385

BASE BUILDING DESIGN

The following points of contacts relate to the design and technical systems of the property. They are the designers on record for the property and offer detailed design insight into the building systems.

BUILDING MEP DESIGNER/ENGINEER

WICK FISHER WHITE

Robert Knese, P.E.

Phone: (215) 627-0200

Wickfisherwhite.com

BUILDING STRUCTURAL DESIGNER/ENGINEER

KEAST & HOODS

Frederick c. Baumert, PE

Phone: (215) 625-0099 x 103

fbaumert@keasthood.com

HISTORIC CONSULTANT

MacRostie Historic Advisors LLC

Bill MacRostie

Phone: (202) 567-6055

macrostie@mac-ha.com

BUILDING CODE OVERVIEW

FDP is zoned for mix use, offering spaces for retail, restaurants, offices, and entertainment. Below are the pertinent property details related to local building codes. It is the sole responsibility of the Tenant's Architect, Engineers, Consultants, and Contractors to comply with all applicable federal, state, and local codes and ordinances for their occupancy type.

BUILDING TYPE

Multi-level mixed-use non-mall commercial building of approximately 1.5M square feet of Gross Leasable Area. Mall building means of egress approved by Board of Building Standards July 2015.

APPROVED OCCUPANCY TYPES

Mixed-Use Mercantile (M)

Assembly (A-2)

Assembly (A-3)

Business (B)

Storage (S-1)

CONSTRUCTION CLASSIFICATION

Type 1A Protected Non-combustible

APPLICABLE CODES

The Pennsylvania Uniform Construction Code is currently enforced by the City of Philadelphia.

Information on Philadelphia's local code requirements can be found at their website:

<https://www.phila.gov/departments/departments-of-licenses-and-inspections/resources/applicable-codes/>

It is the sole responsibility of the Tenant's Architect, Engineers, Consultants, and Contractors to comply with all applicable federal, state, and local codes and ordinances for their occupancy type.

Required Licenses

All tenants need a Commercial Activity License to do business in Philadelphia. This includes businesses that are located outside the city limits that do business in the city. This license links all of your businesses and the legal entity you registered for your Business Income and Receipts Tax (BIRT).

This is a two-step process:

STEP 1 - Get a Tax Account number: here is the information:

- Tax center Guide: <https://www.phila.gov/guides/philadelphia-tax-center/>
- Tax center portal: <https://tax-services.phila.gov/>

-Choose business income tax

STEP 2 – Once Tenant receives their TAX ID # they will need to apply for a commercial activity license (aka CAL)

- For more information see link below;https:

<https://www.phila.gov/services/permits-violations-licenses/get-a-license/business-licenses/activity/get-a-commercial-activity-license/>

PERMITTING

Tenant construction, signage, and food service all require permitting from the City of Philadelphia. Below is a brief overview of the permitting processes. This information is from the City of Philadelphia, as such, specific requirements, timelines, and processes may change.

I. BUILDING PERMIT

For all construction, prior to work commencement, building and other required permits shall be obtained by the Tenant.

Building Permits are filed with the City of Philadelphia Licensing and Inspections department (L&I). Permits are all filed online through L&I's website. Expeditors are permitted to file building permits, but are not required. Drawings can be submitted by an Architect or General Contractor.

The application should include the building drawing set without MEP plans. Individual subcontractors are required to file for separate individual trade permits.

The standard review timeline for the City is 20 business days. Each time L&I makes an inquiry on the review, the timeline resets.

L&I offers an accelerated review option. For an additional fee, the review timeline is decreased to 10 business days.

More information on Building Permit requirements and review fees can be found at L&I's website:

<https://www.phila.gov/services/permits-violations-licenses/apply-for-a-permit/building-and-repair/get-a-building-permit/>

Building and trade permits must be posted in a prominent location in the construction site.

II. SPECIAL INSPECTIONS FORM

Structural steel, welding, and high strength bolting require a special inspection form, submitted by a structural engineer, to certify the integrity of the installation.

This is most commonly encountered for Tenants with a rolling grill entry.

More info can be found at: <https://business.phila.gov/special-inspections-program/>

III. ALCOHOL PERMIT

Tenants serving alcohol must apply for a license with the Philadelphia Liquor Control Board.

The license must be prominently displayed to the public per the license agreement.

More info can be found at: <https://www.lcb.pa.gov/Licensing/Pages/default.aspx>

IV. SIGN PERMIT

INTERIOR SIGNAGE

L&I requires Tenant interior storefront signage to be submitted for permit.

EXTERIOR SIGNAGE

L&I requires all exterior signage to be submitted for a zoning permit.

Any projecting signage (i.e. a blade sign over a sidewalk) will require additional review from the Streets Department and Philadelphia Art Commission prior to submission of the zoning application.

More info on both interior and exterior signage can be found at:

<https://www.phila.gov/services/permits-violations-licenses/apply-for-a-permit/building-and-repair/get-a-building-permit-to-install-signs/>

V. FOOD USE PERMIT

Tenants serving food or beverages must submit a Food Business Review application to the Office of Food Protection. This should be submitted after the Building permit but prior to the start of construction.

An individual plumbing trade permit cannot be filed until the Food Business permit is submitted.

Prior to opening, the Office of Food Protection will conduct a pre-operating walkthrough to issue an operating license.

More info can be found at: <https://business.phila.gov/starting-your-food-related-business/>

OPERATIONS

The following is a brief overview of the site infrastructure available during retail operations and construction.

PARKING

Parking is available in the adjacent, attached parking garage located off Filbert Street.

FDP offers parking vouchers to shoppers and visitors of the property.

Various hard lot parking sites also surround the property and are available for use.

Parking is not available for Tenants or Contractors in the Truck Dock located under FDP.

TRASH

Trash receptacles are available for Tenant and construction refuse at various locations in the Truck Dock.

FDP Operations manages regular receptacle pulls to clear space.

3rd Party refuse companies and containers are not necessary or permitted on site.

DELIVERIES

All merchandise and construction deliveries must route through Fashion District's Truck Dock.

The dock entrance is located off Arch Street and routes underneath the entire length of FDP.

The dock is sized to accommodate full sized trailers.

Delivery drivers are required to check in with security at the dock entrance.

All deliveries must be scheduled using the [DELIVERY FORM](#) linked in the [ADDENDUM](#).

Any construction material that requires a drywall dolly, a pallet jack or a scissor/boom lift must be coordinated with Mall Management. The mall tile must be protected with a minimum of 1" plywood to create a "walk path" for the length of the delivery path. Plywood is not provided by the mall and any deliveries made without protection are subject to fines outlined in the Construction Rules and Regulations document.

SITE UTILITIES AND SERVICES

The following is an overview of the utilities and services typically available for in-line retail spaces. Please refer to lease language for any agreed upon changes that may overwrite these typical service provisions. It is the Tenant's responsibility to verify existing conditions and comply with all applicable codes and standards for all Technical systems.

ELECTRICITY

Tenant shell spaces typically provide an empty conduit to a main power source.

The main power source available for Tenant connections will be 277/480v, 3 phase, 4 wire available from the nearest electrical room.

Power is allocated for each Tenant based off of 15 Watts per square foot.

Electrical use is metered and charged by the Landlord. A separate account with an electrical utility company is not required.

Tenants are required to connect to the electrical sub-meter to accurately monitor their electricity use.

DATA AND COMMUNICATIONS

Tenant shell spaces typically provide a conduit with pull string to nearest Granite rack.

Phone and internet services are provided on-site through Granite Grid.

Tenants must coordinate directly with Granite Grid to set up their data utility.

Other data providers do not have a right of access agreement and are not permitted access to the property.

SPRINKLER SYSTEM

Tenant shell spaces typically provide an automatic sprinkler system according to NFPA guidelines.

Tenants are responsible for contracting with the Landlord's required sprinkler vendor to adjust any existing grids, or install new if none exist, and tie into the main system.

FIRE ALARM SYSTEM

Tenant shell spaces typically provide a nearby junction box to connect to the overall building fire alarm system.

Tenants are responsible for contracting with the Landlord's required fire alarm vendor to install all code-required alarm, horns, strobes, conduit within the Tenant's space to tie into the Landlord's main fire alarm panels.

WATER

Tenant shell spaces typically provide domestic cold water stubbed into the space. Size and location of the pipe varies per space. Spaces also typically provide a sanitary line stubbed into the space or located under the floor slab. Size and location of the line varied per space.

Water use is metered and charged by the Landlord. A separate account with a water utility company is not required.

Tenants are required to install a water sub-meter to accurately monitor their water use.

HVAC

Tenant shell spaces typically provide a supply duct supplying 1.0 CFM per square foot of conditioned (55 degree) forced air. Spaces also typically provide an exhaust stub with an allowance of 150 CFM for Tenant restrooms.

Make-up air (outdoor air) is provided per the rates listed in Chapter 4 of the 2009 edition of the International Mechanical Code for retail occupancy.

Air use is factored into a Tenant's rent based on space square footage.

GAS

Gas utility is not available for in-line retailers.

The property does have a centralized gas service room available for food-use Tenants only.

Additional info can be found in the Addendum for food use Tenants.

> PRE-CONSTRUCTION / CLOSE OUT

CONSTRUCTION

The following is a brief overview of the construction process and requirements for a tenant build outs:

CONTRACTOR REQUIREMENTS

The City of Philadelphia requires harmony with local trade unions.

All tradespersons entering the job site must be current members of a local building trades union and must, at all times, carry on their person such evidence of proof of their membership as may be required by the Landlord.

All materials transported to and from the site must be done so by members of a current local building trades union.

PRE-CONSTRUCTION

Prior to any construction commencement, the contractor's site superintendent is required to meet with the Landlord to review property construction requirements, submit construction documentation, and provide payment for property construction fees.

Required pre-construction documents include:

- Landlord Approved Construction Documents
- Contractors Rules & Regulations to be completed and signed in full
- Approved GC Certificate of Insurance
- A copy of the Building Permit issued by the City
- General Contractor's state license
- Construction Progress Schedule
- Subcontractor List (include associated trade, contact name and phone number)

The Landlord will send a Preparedness Letter detailing the fees required for collection prior to scheduling this pre-construction meeting.

Contractor Rules and Regulations, and Insurance Requirements are linked in the addendum.

INSPECTION PROCESS

During construction Philadelphia's Licensing and Inspection office will require regular inspections. Contractors are responsible for scheduling inspections at key points during their project.

Inspections are scheduled through L&I online permitting system, eCLIPSE.

More info can be found here: <https://www.phila.gov/departments/departments-of-licenses-and-inspections/>

CLOSE OUT

At construction completion, the Landlord will meet with the superintendent to perform a punch list walkthrough. The created punch list is required to be completed to the Landlord's satisfaction in order to close out the construction project. All construction charges must be paid in full. A reference punch list is linked in the addendum.

To complete closeout, the following documents are required to be submitted:

- Copy of Certificate of Occupancy or equivalent and Proof of Passing Final Inspections.
- Final list of Subcontractors (please make any changes or additions from the list supplied at pre-con)
- Unconditional Lien Waivers from all contractors, subcontractors and materials and service suppliers.
- Notarized Affidavit from General Contractor stating that no liens exist as a result of Tenant's work.
- Notarized AIA documents G702 & G703 (if the job is \$100,000.00 or more) / General Contractors Final Billing
- AABC or NEBB Certified Air Balance Report
- As-Built Documents (record set of what was constructed at the site, including Architectural, Structural, Mechanical, Plumbing, Electrical, Fire Protection, etc.) Electronic (PDF) format preferred.

> RULES AND REGULATIONS

CONSTRUCTION RULES

Contractors are required to review and sign each page of the [CONTRACTOR RULES AND REGULATIONS](#) document linked in the [ADDENDUM](#). Below is an overview of some of the rules to follow during construction.

WORK AREA

All of contractor's work, storage of materials, construction office, etc., must be confined to within the Demised Premises. Landlord shall have no responsibility or liability whatsoever for any loss or damage to property belonging to Tenant or its contractor, and left in the Demised Premises or anywhere else.

FIRE PROTECTION

Tenant contractor shall provide fire extinguishers within the premises as required by Landlord's Insurance Company and/or Public Safety Officials.

TEMPORARY STOREFRONT CLOSURES

Barricades will be necessary for all construction projects.

Construction barricades will be built by the Mall and graphics for the barricade will be installed by the Mall and both will be paid for by the Tenant's General Contractor upon check-in. Tenant must provide a proof or spec of the graphic artwork in advance for a timely installation.

Barricades can only pop out a maximum of 36" of the Storefront.

Upon completion of construction and with permission from the Mall operations manager, the Landlord will remove the barricade.

Contact: Jim McGrath

ABC Imaging

Phone: (732) 608-3954

jimmcgrath@peeqimaging.com

USE OF MALL

Access to the Mall shall be subject to control at all times by Landlord's Designated Representative.

At no time shall the Mall be used by Tenant Contractor or its employees for lounging, eating, rest breaks, etc.

Smoking or the use of alcohol is strictly prohibited.

Tenant shall be responsible for seeing that this rule is strictly observed by his contractor(s).

ESCALATORS AND ELEVATORS

Designated freight elevators will be available for transporting materials and personnel. At no time shall Tenant Contractor or its employees use escalators for transporting materials, tools, equipment or personnel.

PROTECTION OF MALL TILE

Common area mall tile must be protected at all times when transporting heavy materials and using a lift. Minimum protection requirement is 3/4" plyboard. Any broken tile as a result of improper floor protection will be replaced at the expense of the contractor.

PROTECTION OF WORK AND PROPERTY

Tenant and Tenant Contractor shall protect their work and the work of other Tenants and Landlord from all damage.

STRICTLY PROHIBITED WORK PRACTICES

- Any combustible materials above finished ceilings or in any other concealed non-sprinklered space.
- Imposing any structural load, temporary or permanent, on any part of the Landlord's work or structure without the approval of Landlord's Engineer.
- Cutting any holes in Landlord installed floor slabs, walls or roof, other than those indicated on the Landlord approved Tenant plans, and tampering or removing fireproofing (if applicable) from demised premises.

CORRECTIVE WORK BY LANDLORD

Any fees which shall become due to Landlord by Tenant or its contractor as a result of, and arising out of, Tenant's construction work (including without limitation, electricity charges during construction, trash removal, and damage to Landlord's property) shall be considered as additional rent, and shall become payable immediately upon demand by Landlord.

SUBMITTALS CONTENT OVERVIEW

6.1

CONSTRUCTION DOCUMENTS

SUBMITTAL REQUIREMENTS FOR ARCHITECTURAL AND TECHNICAL DESIGN DOCUMENTS.

6.2

SIGNAGE DRAWINGS

SUBMITTAL REQUIREMENTS FOR PRIMARY AND SECONDARY STOREFRONT SIGN DESIGNS.

The Submittals Criteria highlights the Landlord review process and drawing submittal requirements to ensure a quick and smooth drawing review for your design and Construction Documents.

Tenant construction and signage drawings must be reviewed and Approved by the Landlord before the drawings can be submitted for permit. Permits from the local Municipality are required for all incoming Tenant construction and signage.

It is always the Tenant's responsibility to ensure:

- Compliance with the Lease document.
- Field verification of conditions and dimensions.
- Discrepancies between the drawings and the as-build conditions.
- Coordination with trades to ensure compliance with all local and national codes.

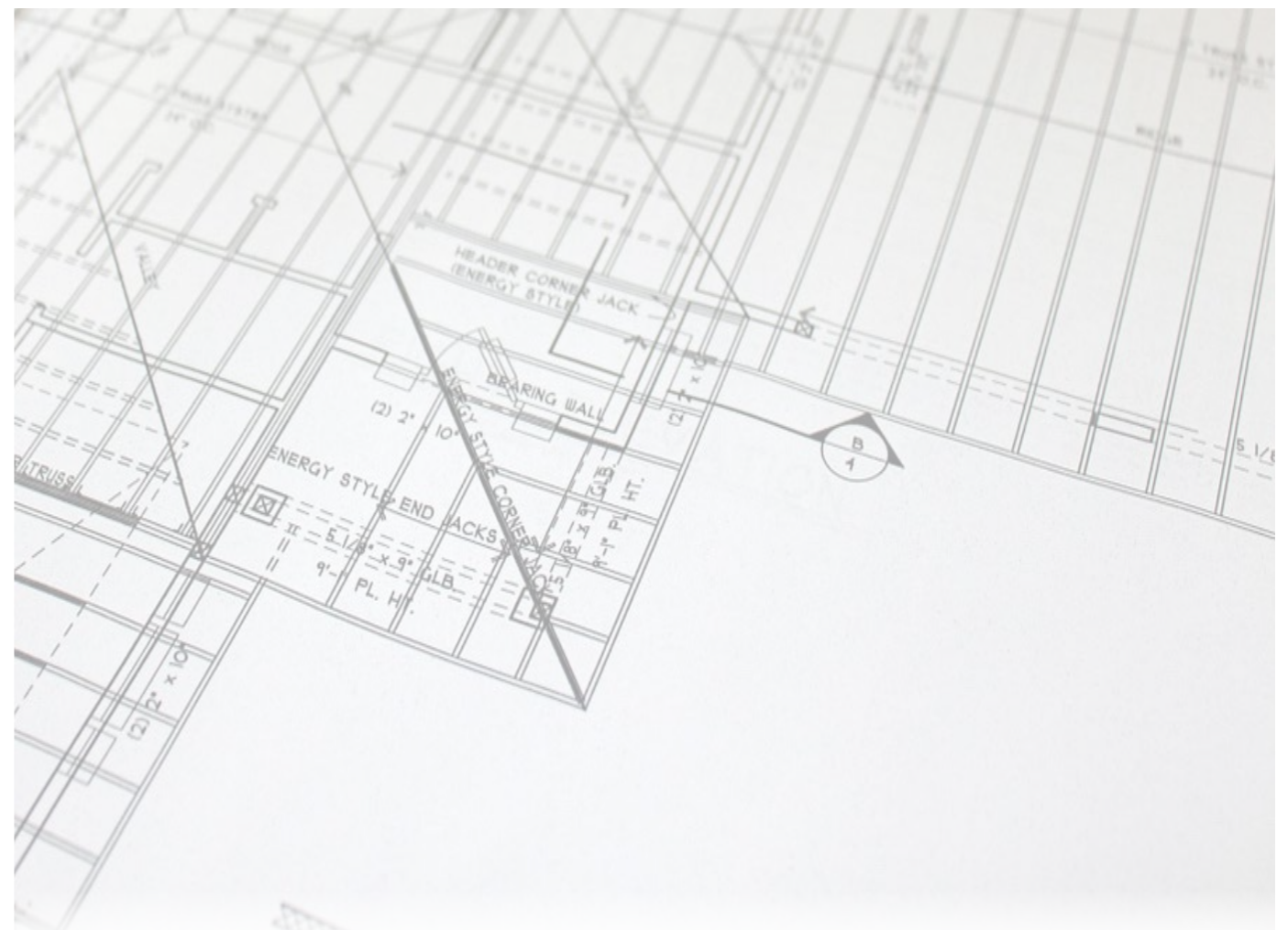

> PROCESS & TIMELINE

DRAWING REVIEW PROCESS

Drawing reviews are required to be submitted in two stages for Landlord review; Preliminary and final Construction Documents. Preliminary drawings are required to ensure the design process moves quickly by ensuring that all Criteria requirements are understood and adopted early in the design. This helps ensure an expedited review of the final Construction Documents.

REVIEW TIMELINE

Step	Action	Time Period
1	Tenant submits preliminary design.	Required 20 days after Lease Execution or 10 days following previous submittal disapproval.
2	Landlord Approved Preliminary Design.	15 days after confirmed completion of Step #1.
3	Tenant submits final construction drawings.	Required 20 days after Tenant Coordinator approval at Step #2.
4	Landlord Approves final documents.	15 days after completion of Step #3.
5	Tenant submits drawings for permit. (If applicable)	5 days after confirmed completion of Step #4.
6	Tenant responds to any requests from or comments by permitting jurisdiction.	5 days.
7	Upon permit review approval, Tenant pays all fees and logs out permit.	5 days.

> SUBMITTAL REQUIREMENTS > PRELIMINARY

PRELIMINARY DESIGN SUBMITTAL

The Preliminary Document review process will evaluate all the criteria discussed in this manual, including overall three-dimensional form, degree of design uniqueness and identity, use and detailing of materials, colors and lighting, and integration of signage and graphics.

Submittals are to provide the reviewer with a clear understanding of proposed design concepts.

The submission must be complete in order to fairly evaluate the proposal and prevent continuation of work on an unacceptable design.

Tenant shall submit to Landlord electronic PDF files of the following:

- **Color and Material Sample Board**
Include actual samples of all Tenant colors and materials visible to the public, on a digital sample board. Clearly label all materials and reference to floor plan elevations.
- **Perspective and/or Photo Image(s)**
Colored perspective rendering and/or prototypical photo images of the proposed storefront, including graphics and signage.
- **Cover Sheet**
Include: Name of Tenant, name of Mall or Center, space number, Applicable Codes, Building Type and Occupancy Type, Leased square footage, and Key Plan.
- **Floor Plan**
¼" Scale Minimum showing: Entire lease dimensioned space with room names, floor finishes, casework and fixture locations.
- **Reflected Ceiling Plan**
¼" Scale Minimum showing: Lighting design, including fixture types and locations, signage, access panels, Overhead projections such as light covers and fascia systems, and Entrance.
- **Sections**
1" Scale Minimum showing: Entry, Display windows and fascia, Sign integration into storefront design.
- **Storefront Elevations**
½ Scale Minimum showing: Exterior views - front and sides, Signs, graphics, logos.

A physical sample board is also required, mounted on foam core or card stock to be sent in coordination with your Tenant Coordinator.

> SUBMITTAL REQUIREMENTS > FINAL

FINAL DRAWING SUBMITTAL

After Preliminary Drawing Approval, it is critical to quickly complete and submit Final Construction Documents for Landlord review.

If any questions arise from the Tenant's interpretation of the design and criteria information, the Tenant shall assume all responsibility for clarification by written request to the Tenant Coordinator. The Landlord plan review and approval process is independent of local permitting for construction. The Tenant is responsible for procurement and compliance with local, state and federal codes and requirements.

Tenant shall submit to Landlord electronic PDF files of the following:

- **Responsibility Schedule**
Any work, which is the Landlord's responsibility, must be listed clearly on a responsibility schedule on the cover sheet.
- **Cover sheet**
Include a Key Plan, Name of Tenant, name of Mall or Center, space number and location leased premises within Mall or Center, Applicable codes, building type and occupancy type, Leased square footage, Responsibility schedule, and Drawing index.
- **Floor Plans**
¼" Scale Minimum showing: Entire lease space with room names, Floor finishes, casework and fixture locations, and Demolition plan.
- **Reflected Ceiling Plan**
¼" Scale Minimum showing: Complete lighting design, including fixture types and locations, signage, access panels, Overhead projections such as light coves and fascia system, Entry, Connection to Landlord's work, Tenant's framing and/or additional structure showing freestanding from Landlord's structure.
- **Sections**
1" Scale Minimum showing: Entry, Display windows and fascia, Sign integration into storefront design, Connection to Landlord's work, Tenant's framing and/or additional structure showing freestanding from Landlord's structure.
- **Interior Elevations**
¼" Scale Minimum showing: All sales floor interior views, Built-in casework, signage, and display systems.
- **Storefront Elevations**
½" Scale Minimum showing: Exterior views - front and sides, Signs, graphics, logos, Landlord neutral piers, Storefront finishes (to be referenced to finish schedule)
- **Architectural Details**
½" Scale Minimum.
- **Door Schedule**
Include floor transition details and anti-theft security system details.
- **Details, Catalogue Cut Sheets, and Fixture Finishes**
- **Finish & Color Schedule**
- **Include CAD/DWG drawing files as part of drawing submission including: Demo plan, Floor plan, MEP plans, and Life safety/ Egress Plans. Please include any background drawings that are necessary to view these files as a comprehensive whole.**

> SUBMITTAL REQUIREMENTS > FINAL ENGINEERING

FINAL DRAWING SUBMITTAL - ENGINEERING DRAWINGS

The Landlord does not review for mechanical, electrical, plumbing, or structural design, nor does the Landlord accept responsibility for the Tenant's adherence to governing codes.

Tenant shall submit to Landlord electronic PDF files of the following engineering drawings included in the final drawing set:

I. MECHANICAL DESIGN DOCUMENTS

- Make, type, and performance of all equipment.
- Sign and seal by a Licensed Engineer in the state where the Shopping Center is located.
- Calculations showing the heating and cooling required, including transmission and ventilation losses in the space, and heat and cooling provided for the ventilation supply, and exhaust required for the space. Calculations must be performed in accordance with the latest ASHRAE standards and tabulated in a concise, orderly manner.
- Temperature control system data showing make, control, and energy management systems.
- Exhaust system layout including CFM and equipment specifications.
- Reflected ceiling plan showing HVAC equipment.
- Roof plan with equipment locations.
- Structural details for support of all rooftop equipment and equipment suspended from the steel structure.

II. PLUMBING DESIGN DOCUMENTS

- Make, type, and performance of all equipment.
- Sign and seal by a Licensed Engineer in the state where the Shopping Center is located.
- Complete plumbing system design and floor plan for the Tenant space including, but not limited to the toilets, sinks, urinals, drains, hot water heaters, water coolers, grease trap/interceptors and connections into existing water and sewer lines.
- Single line diagram.
- Fixture schedule.
- Water heater detail as applicable.
- Grease trap cut sheets as applicable.

III. FIRE PROTECTION / SMOKE EVACUATION DESIGN DOCUMENTS

- Reflected ceiling plan, with revised sprinkler head locations.
- Design must be City approved before construction

IV. ELECTRIC DESIGN DOCUMENTS

- Sign and seal by a Licensed Engineer in the state where the Shopping Center is located.
- Panel schedules, load calculations, and meter information, if applicable.
- Structural drawings for all equipment that will be suspended from the steel structure.
- Electrical load summary and Title 24 Energy Calculations (for State of California).
- Floor plan depicting equipment locations and branch circuitry.
- Reflected ceiling plan depicting the layout of light fixtures.
- System one line diagrams.
- Lighting fixture schedule.
- Equipment legend.

V. STRUCTURAL DESIGN DOCUMENTS

- Design elements affecting the structure of the base building.
- Alterations, additions, modifications and reinforcements to the base building which shall be required to accommodate Tenant's Work.
- All calculations & details (Include ICBO numbers on all framing details, Seismic bracing details for State of California.)
- All forms required by governmental agencies and Governmental Regulations, fully and properly completed and executed by Tenant.
- Partial structural framing plan showing existing conditions for new and existing rooftop installations and proposed reinforcement, which shall be accompanied by structural engineers' calculations, drawn on a scale of 1/2"=1'0".
- Ceiling, soffits, storefront attachment details to existing base building.
- A letter from a state-registered structural engineer certifying that all new equipment and design elements serving the Premises are adequately supported to carry the new load.

> PROCESS & TIMELINE

DRAWING REVIEW PROCESS

Sign drawing reviews are required to be submitted in two stages for Landlord review; Preliminary and final Construction Documents. Preliminary drawings are required to ensure the design process moves quickly by ensuring that all Criteria requirements are understood and adopted early in the design. This helps ensure an expedited review of the final Construction Documents.

REVIEW TIMELINE

Step	Action	Time Period
1	Tenant submits preliminary design.	Required 20 days after Lease Execution or 10 days following previous submittal disapproval.
2	Landlord Approved Preliminary Design.	15 days after confirmed completion of Step #1.
3	Tenant submits final sign drawings.	Required 20 days after Tenant Coordinator approval at Step #2.
4	Landlord Approves final documents.	15 days after completion of Step #3.
5	Tenant submits drawings for permit. (If applicable)	5 days after confirmed completion of Step #4.

> SUBMITTAL REQUIREMENTS > PRELIMINARY, FINAL

PRELIMINARY DESIGN SUBMITTAL

The Preliminary Document review is intended to acquaint the Landlord with the Tenant's signage design intent.

Submittals are to provide the reviewer with a clear understanding of proposed design concepts.

The submission must be complete in order to fairly evaluate the proposal and prevent continuation of work on an unacceptable design.

Tenant's licensed sign contractor shall submit to the Center's Tenant Coordinator electronic PDF files of the following:

- **Perspective and/or Photo Image(s)**
Colored perspective rendering and/or prototypical photo images of the proposed storefront, including graphics and signage.
- **Storefront Elevations**
½ Scale Minimum showing: Exterior views - front and sides, Signs, graphics, and logos highlighting sign dimensions and materials.

FINAL DRAWING SUBMITTAL

After Preliminary Drawing Approval, it is critical to quickly complete and submit Final Construction Documents for Landlord review.

If any questions arise from the Tenant's interpretation of the design and criteria information, the Tenant shall assume all responsibility for clarification by written request to the Tenant Coordinator. The Landlord plan review and approval process is independent of local permitting for construction. The Tenant is responsible for procurement and compliance with local, state and federal codes and requirements.

The Landlord does not accept responsibility for the Tenant's adherence to governing codes or verification of job site conditions.

Tenant's licensed sign contractor shall submit to the Center's Tenant Coordinator electronic PDF files of the following:

- Elevation of the storefront including signage and graphics; showing all doors, architectural features, etc., and fully detailed/dimensioned sections and details through the storefront.
- These fully detailed and dimensioned drawings shall be drawn to scale as noted:
 - Storefront Plan, Elevation and Sectional views at 1/2 inch scale.
 - Details of the Signage at 1/2 inch scale or larger.
 - Storefront Signage at 1/2 inch scale.
- Letter style and typeface specifics.
- Color and finish qualities of all portions of signage.
- Material specifications and thickness.
- Transformer specifications, including input and output voltage of transformers. PK housing, (or other UL approved insulating sleeve approved by Landlord and local building codes), is required for all through wall penetrations and must be indicated on the sign shop drawings. Wiring specifications.
- Locations of service switches, access panels and transformers. NONE of these items shall be visible to the public from any portion of the Mall.
- Neon tube specifications, including color and dimension (in mm) of tubes to be used.
- Type of lamps.
- Mounting hardware.

ADDENDUM LINKS

This Addendum contains links to supplemental documents of specific requirements and information. These documents are considered part of the Tenant Criteria Package. Clicking the links below will navigate to the described documents. It is the responsibility of the Tenant, its contractors, subcontractors, architects, engineers, employees, and agents to comply with terms of the Tenant Criteria, Addendum included.

GLOSSARY

I. [GLOSSARY OF TERMS](#)

Defines commonly used terms for clarity.

DESIGN ADDENDUM

I. [EXTERIOR SIGN CRITERIA](#)

Requirements for design, dimension, and placement of exterior signage.

II. [SPECIALTY LEASING CRITERIA](#)

Design requirements for temporary Tenant's buildout and signage.

III. [READING TERMINAL HEADHOUSE DESIGN CRITERIA](#)

Specific Design Criteria and requirements for Tenants located in the historic Reading Terminal Headhouse.

BARRICADE ADDENDUM

I. [BARRICADE GUIDELINES](#)

Guide to installing and activating construction barricades with graphics.

CONSTRUCTION ADDENDUM

I. [CONTRACTOR RULES AND REGULATIONS](#)

Document detailing the rules and regulations Tenant contractors must adhere to during their construction. This document must be reviewed and signed by the Site Superintendent overseeing the Tenant build out.

II. [INSURANCE REQUIREMENTS](#)

Template for insurance requirements for all contractors working withing the Center. Documents include required additional insured lanaguage.

III. [DELIVERY REQUEST FORM](#)

Required form to schedule deliveries at FDP.

IV. [PUNCH LIST](#)

Reference Landlord Punchlist that that Landlord will use to inspect and confirm completion of Tenant construction.

III. [CONTRACTOR AFFIDAVIT SAMPLE](#)

Required closeout document affidavit sample.

IV. [UNCONDITIONAL LIEN RELEASE](#)

Required closeout document for final unconditional lien releases.