



FASHION OUTLETS
NIAGARA FALLS, USA
SAVE FASHIONABLY

TENANT CRITERIA

MACERICH[®]

VISION STATEMENT

Welcome to Fashion Outlets of Niagara Falls.

It is our vision and mission at Macerich to distinguish ourselves through superior performance in retail development and continuous improvement of our portfolio, to meet the changing needs of our customers and the retailers we serve. Our commitment is to furnish a well-designed, well-maintained and well-marketed retail environment, capable of maximizing traffic and sales.

We are pleased to become partners with retailers, striving for the same goals. We are ready to facilitate communication and share our expertise with you to complete your store within expected timelines.

These criteria act as a guide for the design of all work by Tenants in conjunction with the provisions of the Tenant's lease with the Landlord. Tenants are encouraged to express their own unique design statement within the parameters of the Design Criteria as outlined in this manual.

National and regional "standard" Storefront concepts are respected to the extent that they meet the Design Criteria. However, Tenants should be aware that some concept modifications might be necessary to comply with the Center's Criteria.

The same is true for proposed designs that are overly similar to a neighboring Tenant's Storefront design. We wish to make the Mall as diverse and interesting as possible and enable each Tenant to make a singular statement with their design.



CRITERIA MAIN CONTENTS

1.0 **INLINE**
CRITERIA FOR ARCHITECTURAL, SIGNAGE, AND TECHNICAL DESIGN FOR INLINE RETAIL LOCATIONS.

2.0 **FOOD**
CRITERIA FOR ARCHITECTURAL, SIGNAGE, AND TECHNICAL DESIGN FOR INLINE FOOD, FOOD COURT/HALL, AND RESTAURANTS.

3.0 **BUILDING DETAILS**
ARCHITECTURAL DETAILS, REQUIREMENTS AND REFERENCE PHOTOS BASED ON STORE LOCATION.

4.0 **DESIGN INSPIRATION**
SUGGESTED DESIGN MOTIFS AND INTRO TO KEY DESIGN ELEMENTS.

5.0 **PROPERTY INFO**
PROPERTY LOCATION, CONTACTS, UTILITIES OVERVIEW, OPERATIONS, AND LOCAL PERMITTING INFO.

6.0 **SUBMITTALS**
REQUIREMENTS TO SUBMIT CONSTRUCTION DOCUMENTS, RENDERS, SIGN DRAWINGS, AND MATERIAL BOARDS.

7.0 **ADDENDUM**
SUPPLEMENTAL DESIGN AND CONSTRUCTION REQUIREMENTS AND DETAILS PROVIDED AS LINKS TO EXTERNAL DOCUMENTS.

i **INTERACTIVE NAVIGATION**

This Criteria is an interactive document. You may tap or click the top Navigation Bar or the Side Content Bar to navigate directly to that section.

This page serves as a hub to the various sections included in this Criteria.

The sections in this Criteria break down the key categories of information to understand the design and construction requirements to incorporate a successful retail experience. Refer to the overviews included in the left side bar to learn more about the content included in each section.

It is the responsibility of the Tenant, its contractors, subcontractors, architects, engineers, employees, and agents to comply with terms of the Tenant Criteria, including the supplemental documents included in the Addendum.

The intent of this Criteria manual is to:

- Accelerate the leasing process by providing quick answers to questions about specific requirements.
- Establish the design expectations and technical requirements.
- Establish a coherent design by carefully curating and integrating within the Center.
- Guide the design standards.
- Answer basic questions about the design and construction process.
- Save time by minimizing design reviews.



INLINE RETAIL CONTENT OVERVIEW

1.1

DESIGN

CRITERIA FOR ARCHITECTURAL DESIGN REQUIREMENTS FOR RETAIL STOREFRONTS AND INTERIORS.

1.2

SIGNAGE

CRITERIA FOR PRIMARY AND SECONDARY STOREFRONT AND WINDOW SIGN DESIGNS.

1.3

TECHNICAL

CRITERIA FOR TECHNICAL DESIGN ELEMENTS TO ENSURE YOUR STORE CAN INTERFACE WITH THE PROPERTY'S BASE BUILDING UTILITY SYSTEMS.

SECTIONS OF INTEREST

- BUILDING DETAILS**
Includes property reference photos and specific Storefront design details.
- PROPERTY INFO**
Includes information on the Property's building codes, area permitting, and required contractors.
- SUBMITTALS**
Outlines requirements on how and what to compile for submittals to the Landlord for design reviews.
- DESIGN INSPIRATION**
Provides visual inspirations for design aesthetics.

The Inline Retail Criteria provides key technical information and design requirements to ensure your store enlivens the consumer experience and interfaces with the Center.

The Tenant and the Tenant's Architect assume the following important obligations:

- Fulfill the intent of the Criteria both in concept and in detail.
- Determine and respond to the actual physical conditions of the Tenant's location.
- Maintain and enhance the high standards of quality established in the construction of the Center.
- Ensure the quality of execution of all design material, finish, and detail concepts in the construction of the Tenant's improvement.
- Provide the required detail at all transitions from Tenant Storefront to neighboring Storefronts, as well as to the base building.



DESIGN CRITERIA

❑ STOREFRONTS

- ❑ *ENTRY*
- ❑ *STOREFRONT HEIGHTS / DEMISING PIER / CONSTRUCTION*

❑ DESIGN CONTROL AREA

- ❑ *DESIGN REQUIREMENTS / WINDOW DISPLAY / PROHIBITED DESIGN ELEMENTS*

❑ MATERIALS

- ❑ *GLAZING / DECORATIVE GLASS*
- ❑ *WOOD / STONE / PLASTER*
- ❑ *METAL / LEATHER*
- ❑ *WALLCOVERINGS / SOLID SURFACE*
- ❑ *PAINT / FAUX FINISHES / FABRIC / TILE*

❑ INTERIORS

- ❑ *LIGHTING / FLOORING*
- ❑ *CEILING / WALLS & PARTITIONS*
- ❑ *EGRESS DOORS / RESTROOM*

SECTIONS OF INTEREST

- ❑ *BUILDING DETAILS*
Includes property reference photos and specific Storefront design details.
- ❑ *PROPERTY INFO*
Includes information on the Property's building codes, area permitting, and required contractors.
- ❑ *SUBMITTALS*
Outlines requirements on how and what to compile for submittals to the Landlord for design reviews.
- ❑ *DESIGN INSPIRATION*
Provides visual inspirations for design aesthetics.

Tenants are encouraged to express the individuality of their brand through excellent design by forward thinking design teams.

This Design Criteria focuses on strong design details visible from the Center common areas. Focusing on a strong Storefront design enlivens the retail experience and draws customers in to shop. Macerich's Design team is always excited to partner with Retailers in curating a unique and memorable shopping experience. Our team is available to collaborate on your enticing Storefront designs. The [DESIGN INSPIRATION](#) section is also a great launching point to explore design concepts and methods to engage customers.

- All Tenants must engage a reputable Architect.
- Design drawings must all be reviewed and Approved by the Landlord.
- All design elements and finishes must adhere to local and national building code requirements.



> STOREFRONTS

The Center's success is dependent on the creative design contributed by individual Tenants. It is vital that your Storefront design is integrated with the look and feel of the Center's aesthetic.

The **BUILDING DETAILS** section includes specific storefront design requirements based on your store's location. These location based requirements must be incorporated into your Storefront's final design.



> ENTRY

ENTRY

Your Storefront entry is a critical design feature to create an invitation to shop. As such all stores must express the entry as an identifiable part of the storefront. Fashion Outlets of Niagara Falls requires swing door entries. Rolling grilles or sliding doors are not allowed.

SWING DOOR ENTRY

- Swing doors should be located in a recessed vestibule a minimum of 3' from the Storefront.
- The vestibule may become a larger construction or entry portal when the construction extends beyond the lease line into common areas or pop ups above the Landlord bulkhead.
- Entry construction may not be closer than 4' to the demising pier. A minimum 4' display window is required between the entry and the demising pier.
- No door swing shall project beyond the maximum allowable lease line.
- Minimum allowable door height is 8'-0".
- All other doors are to be hinged or pivot-type doors. Doors are suggested to be the height of the glazed Storefront.
- Frameless glass or custom doors are encouraged.
- Glazing is required in all door types and may be embellished with multiple panes, etching, or decorative glass.
- Recessed entry flooring shall match the Center's flooring requirements.



> HEIGHTS / DEMISING PIER / CONSTRUCTION

STOREFRONT HEIGHTS

All Storefronts must extend up to a maximum heights per the specific location of your store: Storefront heights are either 15'-0" or 18'-0" depending on the store location. Refer to the [BUILDING DETAILS](#) section for specific height details.

DEMISING PIER

Demising piers are located between each interior Tenant storefront and are centered on the demising partition. The pier is the same height as the Tenant storefront. The face of the pier projects beyond the Lease line and is located in plan between the Lease Line and the outside edge of the Landlord's bulkhead. Neutral pier details are identified on the following pages. The Landlord's finishes wrap the pier back to the Tenant's Lease Line. Specific demising pier details can be found in the [BUILDING DETAILS](#) section. General design requirements include:

- The Tenant's storefront system shall abut the side of the pier at the Lease Line.
- Landlord finishes are to be protected and restored if damaged by the Tenant.

STOREFRONT CONSTRUCTION

- All storefront construction shall be self-supported from the floor and independent of the building fascia and bulkhead structure.
- Storefronts may be braced to the overhead structure within the Tenant space.
- Connections to the deck, mall mechanical, electrical, plumbing, or fire protection equipment for support is not permitted. This includes ceiling splay wires.



> DESIGN CONTROL AREA

The Design Control Area (DCA) is the zone extended from the storefront lease line to 6'-0" inside your space, including all display windows and retail graphics, display fixtures, signs, materials, finishes, color and lighting fixtures within the area.

At Macerich, we take special interest in the DCA as an extension of the retail presentation and showcase of the store's merchandising. The intent is to convey excitement, and give the consumer a reason to shop.

Use of a professional Visual Merchandisers is highly encouraged. Design drawings shall have a display layout plan. The layout plan shall have cut sheets for fixture and/or mannequin types and include photographs of any existing Storefronts a Tenant may have that will enhance the layout plan. A rendering is required if photographs are not available.

Stores with both interior and exterior presence must activate both DCA areas. Tenants are encouraged to maintain open visibility into their Store to draw in Customers.



> REQUIREMENTS / WINDOW DISPLAYS / PROHIBITED ELEMENTS

DESIGN REQUIREMENTS

- Ceiling must be a hard surface.
- Lighting fixtures must be consistent with the character of the Storefront design.
- Recess all lighting fixtures.
- A minimal profile track lighting system matching the color of the ceiling plane is allowed.
- Hard bases on the walls are required, including any permitted pop out areas.

WINDOW DISPLAYS

Displays should be deliberate and integrated into the Storefront. Modulation of display systems and built-in architectural components will reinforce the design.

- Display cases must be adequately lit and ventilated.
- Digital monitors are permitted within 10'-0" behind glazing if integrated into the design and approved by Landlord. Coordinate with Tenant Coordinator for exterior applications and to confirm code or local requirements.

PROHIBITED DESIGN ELEMENTS

- Track lighting is not permitted in the DCA.
- Temporary signs for sales or clearances shall not be hung in the DCA or affixed to the glass inside or outside.
- No pegboard, slat wall or metal shelving of any kind may be placed in or extend into any part of the DCA.
- Security devices or freestanding pedestals are not permitted. They must be integrated and concealed.
- Carpet, vinyl or rubber materials of any sort will not be permitted within the DCA.
- Exposure of incandescent bulbs and/or fluorescent tubes are not allowed.



> MATERIALS

As an important aspect of presenting the Tenant's unique brand image, finish materials are to be composed, articulated and executed in a creative and quality manner.

All materials and applied finishes on the Storefront are to be high-grade, durable, non-corrosive and code compliant. They are to be maintained by Tenant at the Tenant's expense. All materials and finishes are subject to Landlord approval, and the inclusion of natural materials is encouraged.

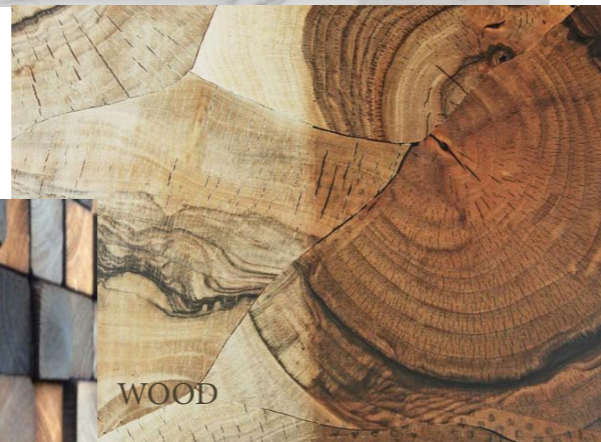

> GLAZING / DECORATIVE GLASS

GLAZING

Storefront glazing, particularly clear glazing, is a key component to establish design character and create an invitation for the customer to visit.

- A minimum of 60% of the Storefront is to be display windows with clear glass.
- Reflective glass (including extensive use of mirror) and/or tinted glass is not permitted on Storefronts or in the Storefront entry zone.
- Tinting or films applied after the glass is installed is prohibited.
- All glass shall be tempered. Glazing must be a minimum of ½" thick, and large panes of glazing must be of sufficient thickness to meet code and be properly supported.
- Tenants may be required to provide seismic clips to stabilize tall expanses of glass. Silicone sealant at glazing joints is not permitted.
- Butt-joint glazing is encouraged for show windows that in-fill larger Storefront forms. Glass shall be clear polished plate or tempered glass as required by code.
- Window mullions are required to meet all material and finish standards.
- Decorative glazing such as colored, beveled, sandblasted or etched glass may be used to create accent pattern and interest. Decorative glazing can be used as an accent, but must meet all material standards.

DECORATIVE GLASS

Decorative glass may be considered to provide a unique feature to the storefront.

- In frame-less assemblies, glass panel joint details edges must be polished, ground or chamfered. Glazing channels at corner conditions must be mitered.
- All exterior glazing units must have a solar heat gain coefficient (SHGC) of not more than 0.27 and a U-value of not more than 0.28.
- Exterior glass must be a minimum of 1" insulated, low E units. 0.27 and a U-value of not more than 0.28.



> STONE / PLASTER / DECORATIVE GLASS

WOOD

Wood material can be used for Storefront construction but must comply with all local and national code requirements.

- Applications of painted or stained wood may include window frames, decorative trim, molding and solid areas, such as decorative bulkheads. In some cases, it may be used for larger architectural elements, such as columns and entablatures.
- Wood paneling and plank construction are not acceptable unless presented in a highly imaginative concept and approved by the Landlord.
- Wood specified for interior Storefronts must be kiln dried, mill quality hardwood and must meet local flame spread requirements (Class III 76-200), as well as comply with all code requirements.
- Painted wood must have a shop quality enamel finish. Wood without a paint finish must receive a clear, preservative sealant.
- A mock-up of the materials, colors, textures, or application may be required at Landlord's discretion.

STONE

Granite, marble, limestone, travertine, slate, adoquin and other natural stone materials may be used for Storefront applications.

Stone may be polished, unpolished, sandblasted, flamed, honed, split-face or carved.

- Natural stone must be protected against staining and discoloration by means of sealers appropriate to the material.
- Craftsman-like attention to detail is required at all connections and transitions to other materials, and we recommend utilizing metal reveals for a clean finish.
- Corner and edge details must prevent visible unfinished edges. Exposed edges must be quirk mitered, chamfered or polished to match adjacent surface finish.

PLASTER

Cement plaster (stucco) and Venetian plaster finishes may be considered for limited storefront applications.

- Apply an even texture of light dash, sand or smooth finish.
- Plaster or stucco should not be the primary Storefront material. Finishes should be used in combination with other high quality materials.



> METAL / LEATHER

METAL

Metal panel may be used to provide alternate texture on a portion of the storefront.

- High quality is expected for all metal applications, including careful finishing and quality fastener detailing.
- Metals may include: shop-painted aluminum and steel, stainless steel, solid brass, bronze, pewter, or enamel coated steel, and may be used for hardware, trim and panels when well designed and detailed.
- The following notes on metal material details must be called out on the submitted drawing set:
 - Minimum 1/2" thick fire-rated plywood or other solid substrate is required behind all metal panels.
 - Minimum 18 gauge metal panels are required.
 - All seams between metal panels must be identified on the storefront elevation and must be properly addressed during design review process.
- The following metal surface treatments are not allowed:
 - Oil canning (resulting from light reflection on an uneven or buckled surface)
 - Scratches
 - Warps, dents, occlusions
 - Visible seams or other imperfections
- Reveals, turn-in seams, welding or similar must be specified and detailed for approval. Metal panels will not be allowed to directly come into contact with adjacent panel or other materials.
- No visible fasteners are permitted.
- Lap joints and seams must be even, straight, and concealed when possible. Outside corners are to be mitered or continuous break shaped.
- Sealants on natural metals are required to prevent tarnishing and must be maintained by Tenant at Tenant's expense.



LEATHER

The use of leather "tiles" for vertical application can add a level of depth and texture to the Storefront. However, these tiles should not be used at an elevation that can be reached by the general population due to the delicate finish and to prevent damage over time.

- The Landlord recommends keeping the use of leather tiles on the Storefront above 7'-0" AFF.



> WALLCOVERINGS / SOLID SURFACES

WALLCOVERINGS

Wallcoverings can add depth and texture to Tenant Storefronts, but need to be applied accordingly based on the durability of the product.

Vinyl, Paper, or Fabric Wallcoverings are not considered durable and are expressly prohibited in the use of Tenant Storefronts.

- Any wallcoverings located at pedestrian level (below 7'-0" AFF) must be extremely durable and rated by the manufacturer for high traffic use.
- Any wallcoverings located above pedestrian level (higher than 7'-0" AFF) must be durable and washable for maintenance purposes.
- Removable/repositionable wall coverings are not permitted for Storefront use.
- All wallcovering applications must appear seamless and be securely affixed with commercial grade adhesive rated for high traffic use covering the entire back of the product.
- All maintenance of wallcoverings is by Tenant. No peeling, bubbling, or other separation of the wallcovering from the applied substrate is permitted to remain, and is the responsibility of the Tenant to repair in a time frame deemed acceptable by the Landlord.



SOLID SURFACE

The use of large format solid surface panels can effectively mimic luxury materials in places where cost may be an issue (IE: Caesar Stone or Cambria), or to provide even, diffuse lighting elements in the storefront (IE: Lumicor or 3Form).

- All solid surface products must be rated for heavy duty commercial applications – residential quality products are not permitted.
- Joints, flat seams, and corner conditions of solid surface materials must be tight and seamless.
- All visible edges must be finished to the same level and quality as the front face of the material.
- If the body of the product is not consistent throughout, a mitered corner detail is required to keep the presentation clean.
- All corners and edges must be eased for safety purposes.
- No adhesive can be visible in the final application.



> PAINT / FAUX FINISHES / FABRICS / TILE

PAINT

- Surfaces should be maintained as an even and durable surface finish, at all times.
- Any paint application should show uniformity without evidence of touch-ups or batch variation.
- Paint should be colorfast, and well executed to prevent lap marks, brush marks, or poor coverage.
- Surfaces and materials shall be prepared and staged correctly to avoid problem conditions such as poor adhesion, sagging, chipping or flashing.
- Painted metal surfaces are not allowed.
- Painted gypsum board is not permitted on the storefront unless there is a factory applied finish of baked enamel or powder coat treatment.
- Painted MDF may be used with a finish process of 1 coat primer, 2 coats finish (sprayed and sanded between each step). Minimum thickness of the MDF is 3/4" on Storefronts.

FAUX FINISHES

Faux finishes may be used at the Landlord's discretion.

- Actual samples of the faux finish must be submitted to the Landlord. Photographs of previous examples are helpful but may not be substituted for an actual sample.
- Faux finishes must be executed by a commercial artisan specializing in that medium.

FABRICS

- Fabrics shall be commercial grade and tested in accordance with ACT Guidelines.
- Specifics for flammability and four aspects of fabric durability: Wet & Dry Crocking, Colorfastness to Light, Physical Properties, and Abrasion are to be documented for each fabric specified and available for Landlord review if requested.

TILE

- Tile may be used in diverse applications and is encouraged to introduce light, texture, and graphic quality to a Storefront.
- Porcelain, cermaic, or glass tile in glazed or natural finishes may be used as accents and in limited field applications. Patterns over a large area must be sophisticated and well executed.
- Small intricate mosaic tile may be utilized for detail and accents only.
- Lapped or butt joints are not permitted. Outside cornered must be bull nose edge or special corner trim.
- Grout color should match the background color of the tile so as not to emphasise the grid.



> INTERIORS > LIGHTING / FLOORING

The store interior design should emphasize your merchandise and create an exciting experience for the customer.

It is the Tenant's responsibility to survey, capture and address all existing conditions within the space.

LIGHTING

Lighting can greatly contribute to the design of a Tenant's store, by emphasizing architectural forms as well as highlighting signage, adding color and visual drama to walls and other design elements. The creative use of dramatic lighting is encouraged at entries, show windows and merchandise displays.

- Fixtures must be positioned to avoid glare directed into public areas. Do not over light.
- Wall sconces or decorative lamping may be used to cast light onto storefront forms, provided that bare bulbs are not exposed and that the finish and form of these fixtures coordinate with the overall Storefront design. Fixture cut sheets are required.
- Sconces shall be commercial grade in quality and size.
- Residential scaled sconces are not acceptable.
- Colors are subject to Landlord approval.
- 2'x2' or 2'x4' prismatic fluorescent lights are not allowed.
- Track lights shall be finished to match the ceiling.
- Strobe, spinner, or chase type lighting is not permitted.



FLOORING

- Finished flooring is required in the full premises including in the recessed entry conditions and storage areas of the store.
- Hard surface base is required in all sales areas.
- Ensure floor material is durable and non-slip.
- Carpet must be commercial grade and meet local code required fire-proof ratings.
- Exposed concrete floors must be sealed.
- Transitions between flooring and common areas must be flush.
- Tenant is responsible to mitigate any/all ADA issues and clear with the appropriate municipality.



> CEILING / WALLS & PARTITIONS

CEILING

- Stores 800 s.f or less must have a gyp board ceiling, not an acoustic panel ceiling.
- Recessed entry conditions must have a finished soffit matching the storefront.
- Concealed light covers to highlight architectural elements are encouraged.
- Multi-level ceilings are encouraged.
- Gypsum wallboard, concealed spline, decorative patterned ceiling panels, and other “high-tech” materials are encouraged.
- Standard 24” x 48” acoustical panels are not allowed in sales areas.
- Sprinkler heads are to be fully recessed in hard or acoustical ceilings.
- All ceiling material shall be non-combustible. No combustible materials may be used above the finished ceiling.

WALLS & PARTITIONS

- Demising walls are not designed to accommodate cantilevered or eccentric loads. If Tenant plans to use a demising wall for support of shelf standards, light soffits or heavy attachments, Tenant shall reinforce the wall as required by providing additional steel studs or independent supports for the shelf standards.
- Demising walls and ceiling shall be sound insulated to achieve a minimum STC rating of 50 by Tenants who produce above 80 dB (including but not limited to music stores, arcades, etc.) The Landlord will strictly enforce all Tenants’ right to quiet enjoyment of their Leased Premises.
- Tenant shall protect fire proofed columns and braces with gypsum board, and furr as required.
- The following are required for hair salons, pet shops and all food preparation type Tenants:
 - Walls containing “wet” areas to be constructed of metal studs with water resistant 5/8” type “x” gypsum board.
 - Demising walls of pet shops shall have sheet metal installed on studs, behind drywall, up 3’-0” from floor.
- When Tenant chooses not to install a ceiling within Tenant’s stockroom, Tenant shall extend the partition separating the stockroom from other areas of the store, to the underside of the structure above in order to isolate the stockroom from the sales area attic space. Tenant to verify if this is allowed by code.
- Metal or plastic laminate inserts are required for slatwall. No visible substrate at slats.
- Recessed wall standards are permitted.
- No open shelving with visible brackets or surface mounted systems are allowed.



> EGRESS DOORS / RESTROOM

EGRESS / SERVICE DOORS

- All secondary exit doors shall be backset so that the door does not swing into the corridor, or exit passageway.
- Doors entering a common exit passageway or corridor shall be labeled with the Tenant name and space number.

RESTROOM

- 3" Floor drain and cleanout are required.
- Each restroom must have an exhaust system.
- A waterproof membrane beneath the finish floor surface up to a height of 4" along all walls is required.
- Floor finishes in toilet rooms shall be ceramic tile with a coved 6" base.
- Toilet room walls and ceiling shall be constructed of metal studs with water-resistant 5/8" type "x" gyp board.
- A water shut-off valve is required at eye level.



SIGN CRITERIA > CONTENTS

PRIMARY SIGNAGE

- CONTENT / DESIGN ELEMENTS*
- PLACEMENT / DIMENSIONS / CONSTRUCTION*

SECONDARY SIGNAGE

- WINDOWS / THRESHOLD*
- AWNINGS / BLADES*
- PROHIBITED ELEMENTS*

EXTERIOR SIGNAGE

- LIGHTING / DIMENSIONS / DESIGN & FABRICATION*
- INSTALLATION / SPACE IDENTIFICATION*

SECTIONS OF INTEREST

BUILDING DETAILS

Includes property reference photos and specific Storefront design details.

PROPERTY INFO

Includes information on the Property's building codes, area permitting, and required contractors.

SUBMITTALS

Outlines requirements on how and what to compile for submittals to the Landlord for design reviews.

ADDENDUM

Includes additional info on exterior signage requirements.

Storefront signs are vital to the successful function of the Center.

The goal of this Criteria is to produce a colorful collage of signage that tastefully informs, delights, and stimulates the shopper.

All sign materials must be consistent with the design theme, enhancing the storefront and evoking a positive retail image.

Due to the variety of architectural treatments within the Center, each Storefront sign will be carefully considered in relationship to its particular location. What may be appropriate in one location may not work in another. Each proposed sign will be evaluated on its originality and compatibility with neighboring signs, and its overall image within the Shopping Center.

The Landlord reserves the right to disapprove any sign design that is not compatible with these criteria and the aesthetics of the Shopping Center.

This Criteria is intended to harmonize with the leasing documents. It is the responsibility of the Tenant to forward a copy of these Criteria to their architect, contractor and various consultants.

No deviation from the enclosed Criteria requirements will be accepted without prior written approval from Macerich.

Signage design and construction must be code compliant.



> PRIMARY SIGNAGE

Your primary sign is an opportunity to express your Brand's identity and individuality at the entry portal of your store.

The following sign types are encouraged as design options for your primary signage:

- **REVERSE CHANNEL (HALO LETTERS)** minimum of 3" deep and projected from the background.
- **INTERNALLY ILLUMINATED** sign housings having unique shapes with letters routed out and formed letters protruding beyond the routed out letter.
- **EDGE-LIT, SANDBLASTED GLASS** with a continuous light source.
- **CAST METAL LETTERS** raised or flush with the fascia surface.
- **GOLD LEAF** on glass or stone.
- **SILK-SCREENED** glass or metal panels.
- **INDIRECT ILLUMINATION** on non-internally illuminated signs (artisan type panel signs).

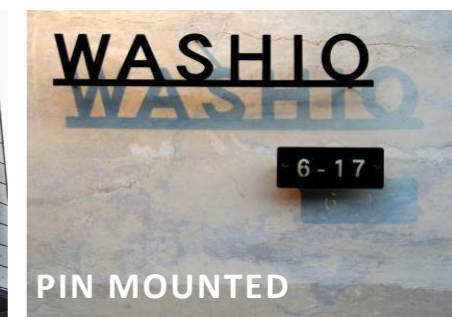
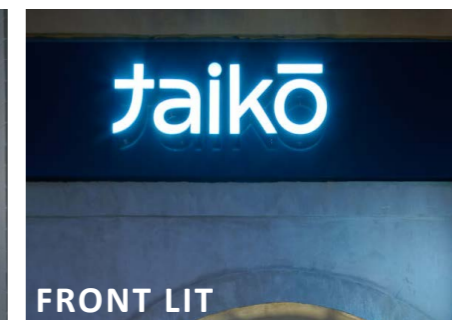
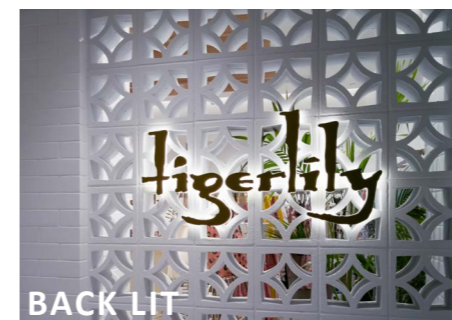

> CONTENT / DESIGN ELEMENTS

SIGN CONTENT

- Sign wording is limited to the Tenant's trade name and shall not include specification of merchandise sold or services rendered, regardless of the Tenant's legal name. Corporate crests, logos or insignia may be acceptable pending the Landlord's approval and provided they are part of the Tenant's name.

SIGN DESIGN ELEMENTS

- All primary Storefront signs must be illuminated. External illumination designs are subject to Landlord approval.
- Imaginative signs utilizing a variety of materials are encouraged. Adaptation of current sign practices may be necessary in order to comply with these criteria.
- Backlit components must be contained wholly within the depth of the letter. Maximum brightness may not exceed one hundred (100) foot-candles.



> PLACEMENT / DIMENSIONS / CONSTRUCTION

SIGN PLACEMENT

- One sign is permitted per store frontage unless additional signage is approved by Tenant Coordinator. Tenants occupying corner spaces may utilize one sign per elevation with a maximum of two (2) signs, or one sign on a diagonal corner. For unusually long tenant storefronts, more than one sign may be allowed, with Landlord approval.
- Bottom of sign to be at 9'-0" A.F.F. minimum.

SIGN DIMENSIONS

- Signs shall be designed as an integral part of the storefront, with letter size and location proportional to the overall storefront design, and in compliance with the Design Criteria.
- Letter size: must be proportional. Max allowed for height of letter is 13% of overall storefront height. Example - a storefront that is 12'-0" in height will be allowed to have a maximum letter height of 18.72".
- Letter dimensions of greater proportions may be considered if, in the Landlord's opinion, the sign design is of exceptional merit and architectural quality.

SIGN CONSTRUCTION/INSTALLATION

- All Storefront signage and lighting, both interior and exterior, are required to be on a separate circuit and controlled by a time clock. Storefront signage and lighting are required to be on during operating hours and off during non-operating hours. This includes exterior building Storefront signage.
- Electrical raceways are not to be visible.
- High quality fabrications are required. Hums, flickers and light leaks are not permitted. Attachment devices, bolts, clips, threaded rods, fasteners, tubes, raceways, conduit, and other mechanisms are to be concealed. All labels must be away from public view. Signs must comply with all codes and regulations, must bear the UL label, and must have current sign permits.
- Tenant may use Landlord bulkhead for lateral bracing only.
- Threaded rods or anchor bolts shall be used to mount sign letters spaced out from background pane. Angle clips attached to letter sides will not be permitted. All bolts, fastenings, and clips shall be of hot-dipped galvanized iron, stainless steel, aluminum, brass or bronze, and no black iron materials of any type shall be permitted.
- Advertising placards, banners, pennants, names, insignia, trade-marks and other descriptive material may not be attached to the storefront or glazing.
- Visible weep holes are not permitted.
- Any existing holes from previous Tenant signage must be patched and painted.



> SECONDARY SIGNAGE

In addition to the Primary Sign, all signage visible from the exterior of the store are considered Tenant Signs. These do not include messages used to advertise products, sales, or special events. Several various Secondary Signs are allowed at the Center and detailed in this section.

The following general Secondary Sign requirements must be met by all Sign varieties:

GENERAL

- Signs must be kept within the the lease line.
- Signs must be in proportion to the overall storefront and composition.

MESSAGING

- Trade name and/or logo only, are allowed.
- No taglines may be incorporated.
- Established logos will be allowed and will be counted in the overall area calculations.



> WINDOW / THRESHOLD

Secondary signage types and their requirements include:

STOREFRONT WINDOW SIGNS

If the Tenant wishes to provide additional Tenant identity, it is to be located at the pedestrian level on the inside face of the Storefront glass.

- Glazing signs are to be translucent (similar to frosted glass), reverse-reading and applied directly to the interior of the glass surface.
- Tenant graphics on Storefront glass shall be computer cut fat vinyl graphics (text/letter/logos)
- Maximum allowable area of signage is subject to Landlord's review and approval.
- Tenant graphics/logo will be limited to a maximum of three (3") inches in height.

THRESHOLD SIGNS

In addition to Storefront signs, Tenants are encouraged to incorporate signs into their entry way flooring. Landlord will review threshold signs on an individual basis.

- Threshold signs are to be graphics comprised of logos, crests and accent.
- Finish is to be flush with adjacent materials and consistent with entry flooring quality.
- Recommended materials are wood, tile, stone, metal and terrazzo inlays.
- Threshold signs are not to extend beyond their lease line into the Center.



> AWNINGS / BLADE SIGNS

AWNINGS

Some Tenant Storefront designs include projected awnings. Landlord will review awnings and their signage on an individual basis.

- Glass or metal are the preferred materials of choice, although fabric awnings will be considered.
- Awning signage may be considered as the main Tenant's identification at the sole discretion of the Landlord in the interior of the Mall only.
- Signage may occur on the valence of the awning and may be painted or silk screened in a contrasting color.
- Logos shall be silk-screened and submitted with awning and sign drawings. Size of the logo shall be proportionate to the overall width of the awning and subject to Landlord's approval.
- The lowest point of the awning or shade shall be a minimum of eight feet (8'-0") above the finished floor. It is the designer's responsibility to ensure that awnings conform to all applicable codes.
- Materials such as Pana-flex, plastic or other vinyl materials shall not be permitted.
- Awnings shall be cleared and maintained in good condition at the sole expense of the Tenant
- Wording on awnings is limited to Tenant's DBA only.

BLADE SIGNS

Tenant Blade signs consist of metal bracket, painted metal frame detail, and painted metal panel with tenant logo screen printed on first surface.

A projected or suspended blade sign in front of the store will be allowed if in the opinion of the Landlord additional signage is merited due to the visibility or location of the storefront sign.

Specific bracket details are shown on the following page. In addition to the standard bracket details, the following requirements must be followed:

- Illuminated signs are not allowed.
- The Blade Sign's letters shall be a minimum of 4" high. Graphics must be three dimensional.
- Maximum blade sign size is 6 sq f. Maximum projection is 3'-6" including bracket.
- The maximum thickness, including all sculptural elements is 6".
- Aluminum square tube structure. Sign fabricator is responsible for engineering sign structure and mounting system for appropriate attachment for overhead safety and stability.



> BLADE SIGN DETAILS

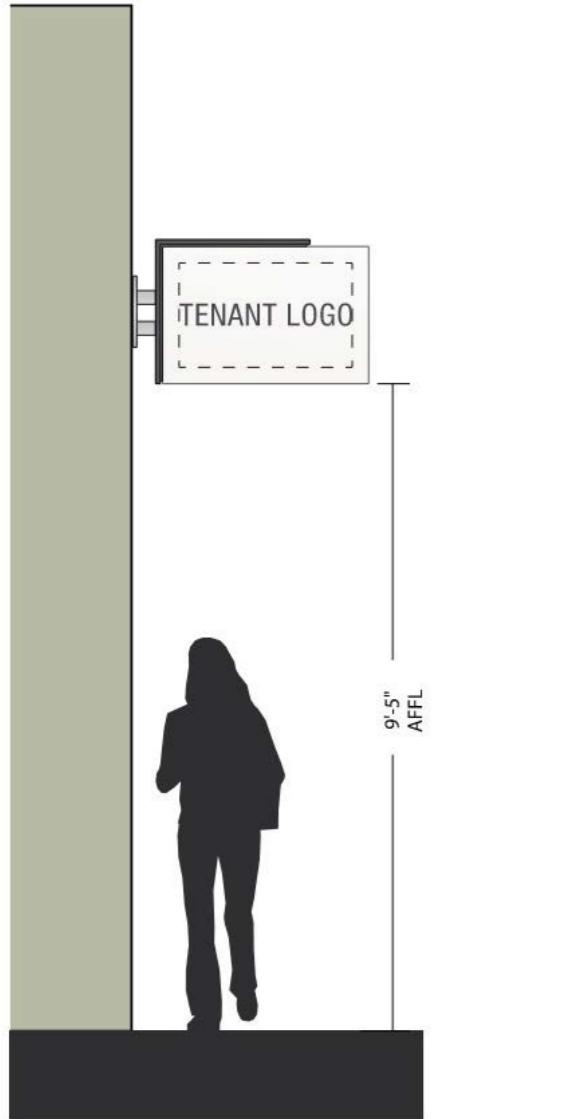

1 Context Elevation | Horizontal Tenant Blade
Scale: 1/2" = 1'-0"

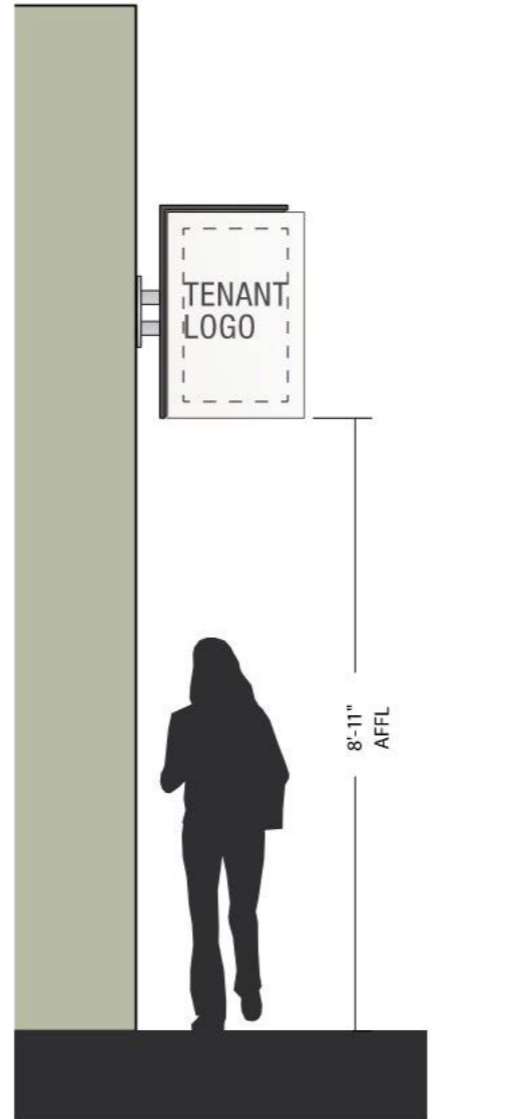

2 Context Elevation | Vertical Tenant Blade
Scale: 1/2" = 1'-0"

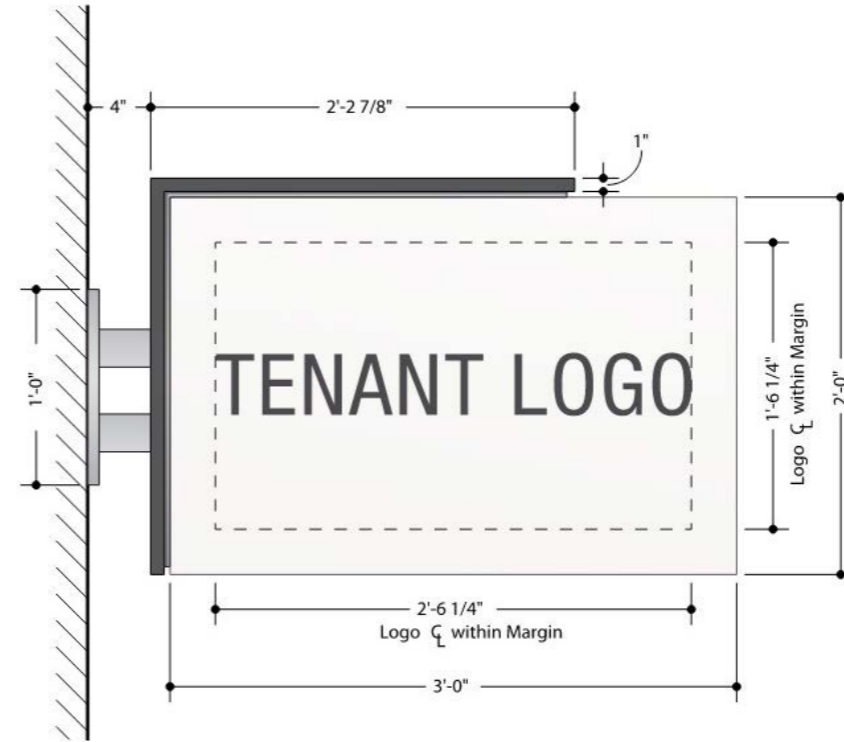

1 Elevation | Horizontal Tenant Blade
Scale: 1 1/2" = 1'-0"

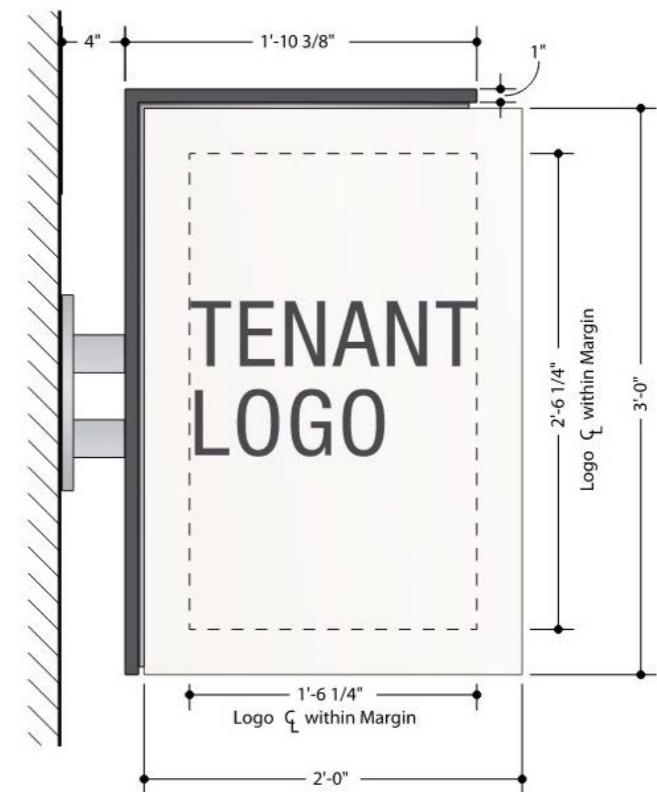

2 Elevation | Vertical Tenant Blade
Scale: 1 1/2" = 1'-0"

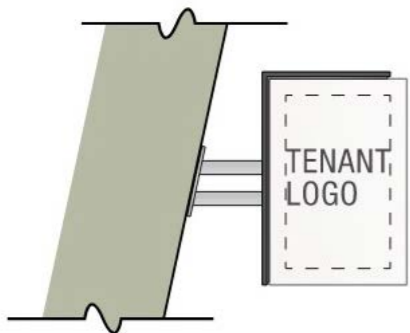

3 Varying Mounting Conditions
Scale: 1/2" = 1'-0"



3 Elevation | Horizontal Tenant Blade
Scale: 1 1/2" = 1'-0"



> PROHIBITED SIGNS AND MATERIALS

PROHIBITED SIGNS AND MATERIALS

The following sign types and materials are not permitted:

- Internally illuminated plexi-faced channel letters.
- Vacuum-formed or injection-molded plastic signs.
- Cabinet or standard “can type” signs with illuminated translucent backgrounds and silhouetted letters.
- Exposed skeleton neon applied directly to fascia element.
- Temporary or ‘sales’ signs attached to Storefront.
- Freestanding tripod signs.
- Flashing, scintillating, moving, sequencing, audible or odor producing signs.
- Paper, cardboard and Styrofoam signs.
- Credit card and advertising placards, decals, stickers or trademarks.
- Manufacturer labels.
- Carpet or rubber entry mat signs.
- Internally illuminated awnings.
- Signs employing un-edged or uncapped plastic logos or letters with no returns and exposed fastenings.
- No simulated materials (IE: wood grained plastic laminates, Zolatone etc.) or wall covering permitted.
- Signs painted on Storefront.
- No radioactive material shall be allowed to be used or installed as part of any Tenant construction scope of work. Furthermore, no radioactive signs such as Tritium exit signs shall be allowed in our Shopping Centers.



> EXTERIOR SIGNAGE > LIGHTING / DIMENSION / DESIGN & FABRICATION

The following additional requirements must also be followed regarding Exterior Signage:

LIGHTING REQUIREMENTS

- Metal letters, back lit (halo effect) with warm white light (3200K^o - 3500K^o). Letters must be a minimum of 6" in depth, and must be projected from the background with one inch spacers.
- Internally illuminated channel letters, with opaque sides and plastic faces, (3200K^o - 3500K^o) luminous tubing illumination within letters. Letters should not be more than 9" in depth. The Plexi-glass color will be determined on an individual mall basis. Trim caps are to match letter color.
- Letters are to be individually illuminated with white neon.

DIMENSION REQUIREMENTS

- Store sign shall not exceed 70% of the Storefront width, a distance which shall be determined by the lineal footage of the Tenants lease line.
- Logos cannot exceed 30" square depending upon the application.
- Uppercase letters shall not exceed 24" in height.
- Lowercase letters shall not exceed 20" in height

DESIGN AND FABRICATION REQUIREMENTS

- While the letters are to be individually illuminated with white neon, the "Plexiglas" color is to be determined on an individual mall basis. Trim caps are to match letter color.
- No exposed raceways, crossovers, conduit conductors, transformers, etc. shall be permitted.
- All signage and sign components shall be UL listed.
- All exterior signage components (logos and all individual letters) shall stand off the face of the wall surface by a distance of 1/4 inch. This shall be accomplished by the use of nylon spacers placed between the face of the wall and the back of the logo or letter.
- All metal letters shall be fabricated using full-welded construction.



> INSTALLATION / SPACE IDENTIFICATION

INSTALL AND CONSTRUCTION REQUIREMENTS

- A building permit, Mall and City approval shall be obtained prior to sign installation.
- All sign installation will be coordinated with the Landlord prior to initiation of any work by the Tenant and/or his subcontractors.
- Tenant is responsible for the operation of the Tenant's sign contractor.
- The sign contractor, on drawings submitted to the Landlord, shall indicate location of all openings for conduit sleeves and supports in sign panels of building walls. Sign contractor shall install signage in accordance with the approved drawings and building codes.
- Tenant's sign contractor shall repair any damage to any finishes caused by his work.
- All signs, bolts, fastenings, and clips shall be of hot-dipped galvanized iron, stainless steel, aluminum, brass or bronze, and no black iron materials of any type shall be permitted. No toggle bolts shall be used for sign attachments.
- Electrical service to the Tenant's sign shall be installed by the Tenant and not be part of the Landlord's operating costs. The sign shall be controlled by a time clock.
- Any existing holes from previous Tenant signage must be patched and painted.

EXTERIOR SPACE IDENTIFICATION

- If Tenant has a non-customer door for receiving merchandise, Tenant may place its name and address on said door in a location approved in writing by Landlord's Tenant Coordinator, using two inch (2") high block letters. Where more than one (1) Tenant uses the same door, each name and address may be applied. Landlord's Tenant Coordinator shall also specify the size, type and color of numbers.
- Tenant may install on its Mall Storefront, if required by the US Postal Service, only the numbers of Tenant's street address and only in such location as Landlord shall specify. Landlord's Tenant Coordinator shall also specify size, type and color of numbers.



TECHNICAL CRITERIA > CONTENTS

- ELECTRICAL**
 - POWER SOURCE / SYSTEM REQUIREMENTS
 - DEMAND LOAD / DATA / LIGHTING

- LIFE SAFETY**
 - SPRINKLER
 - FIRE ALARM
 - EGRESS

- PLUMBING**
 - REQUIREMENTS

- MECHANICAL**
 - GENERAL REQUIREMENTS
 - KITCHEN EXHAUST REQUIREMENTS

- SUB SLAB AND VAPOR BARRIER**
 - DESIGN DETAILS
 - UNDER SLAB INSTRUCTIONS
 - CRAWL SPACE INSTRUCTIONS
 - TRENCH REPAIR

SECTIONS OF INTEREST

- BUILDING DETAILS**

Includes Property reference photos and specific Storefront design details.
- PROPERTY INFO**

Includes information on the Property's building codes, area permitting, and required contractors.
- SUBMITTALS**

Outlines requirements on how and what to compile for submittals to the Landlord for design reviews.
- ADDENDUM**

Includes additional info on exterior signage requirements.

The Inline Technical Criteria provides buildings details and design requirements for the Center's technical systems.

It is the Tenant's responsibility to verify existing conditions and comply with all applicable codes and standards for technical systems.

Tenants are required to adhere to the full Criteria during their design and construction.

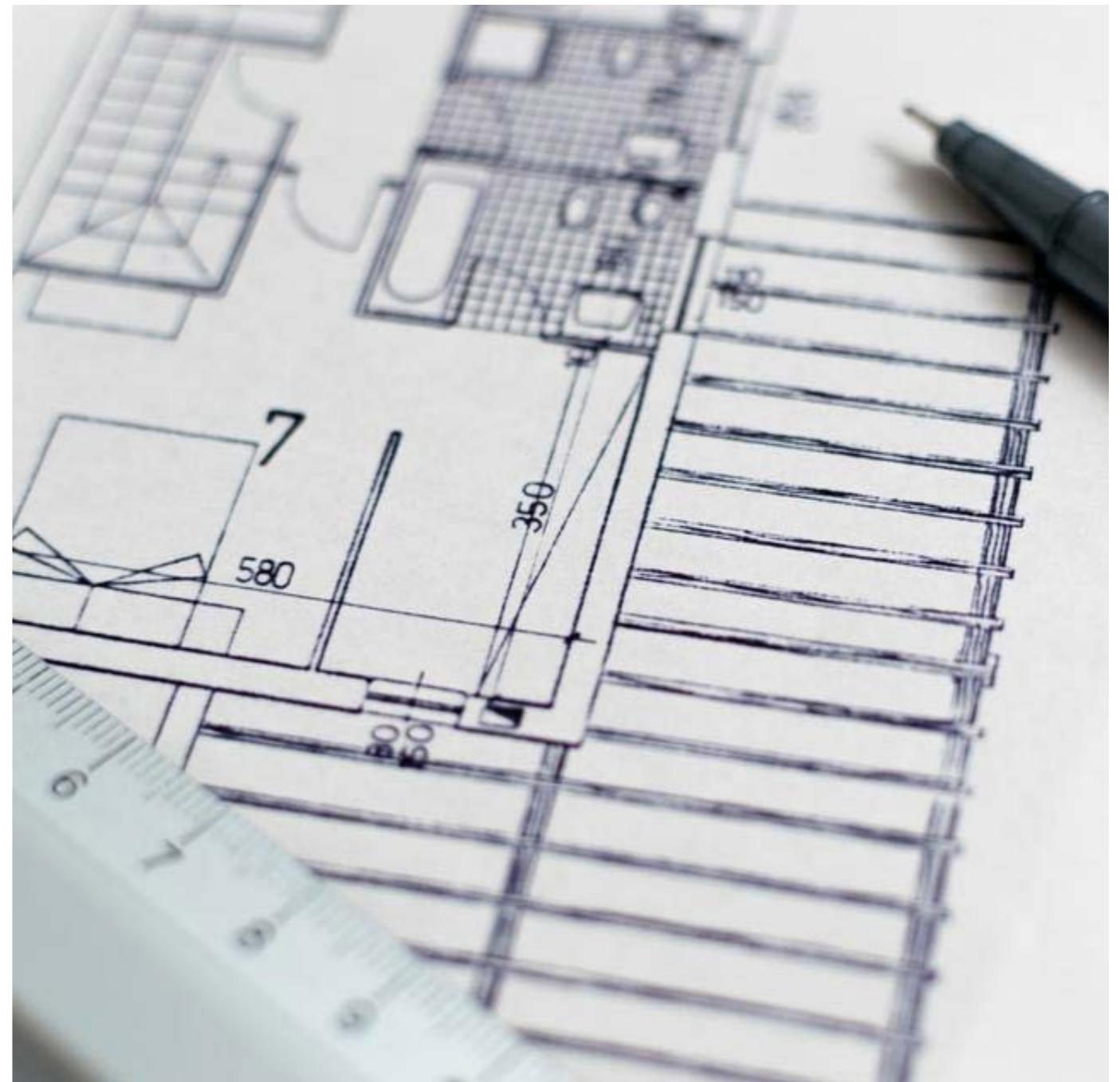

> ELECTRICAL > POWER SOURCE / SYSTEM REQUIREMENTS

PROVIDED POWER SOURCE

Tenant shell spaces typically provide an empty conduit to a main power source. The main power source available for Tenant connections will be 277/480v or 120/208v, 3 phase, 4 wire available from the nearest electrical room.

SYSTEM REQUIREMENTS

- Materials, products, equipment, including components thereof, systems and methods shall be new and be identified by Underwriter's Laboratories, Inc. as suitable for the purpose, and shall meet the requirements of the National Electrical Code, IEEE Gray Book and of local authorities having jurisdiction. Materials, products and equipment, including components thereof, shall be sized and installed in conformity with the requirements of other recognized standards, such as ASTM, IEEE, IPCEA, NFPA and NEMA, where the requirements of such standards are more stringent than those cited above.
- The Tenant shall verify the existing service size and all service equipment and locations. Modifications or replacement of any equipment is by the Tenant at the Tenant's expense. Increased service size shall be reviewed by the Landlord. Tenant will provide its own feeder, distribution panels, dry-type transformer (if needed) for other voltages and all other equipment as required. Transformer installations shall be located in the Tenant premises and shall conform to NEC and local code requirements with respect to location, mounting, grounding and over current protection.
- All service equipment (including but not limited to distribution centers, circuit breakers, switches, transformers, etc.) must be sized at 125% of Tenant's stated cumulative coincident demand.
- All conductors shall be soft-drawn annealed copper. Minimum size shall be #12 for power wiring and #14 for control wiring. Wire shall be 600 volts insulated, NEC type THW, or THHN/THWN. All wire shall be run generally in rigid conduit or EMT. MC cable is permitted for lighting and convenience receptacles when located in concealed ceilings or walls. Plastic or flexible conduit is permitted only for final connection to motors.
- Tenant distribution and lighting panel boards shall be of the three phase, four wire distributed phasing type. Tenant's circuiting shall be arranged to present, as nearly as possible, an evenly balanced load on all phases. Panelboards shall be circuit breaker type. All circuit breakers shall have Amperage Interrupting Capacity (AIC) at least 10% greater than the available fault current at the breaker location, as calculated by the Tenant's engineer. AIC shall be stated on the Tenant's panel board schedule.
- All interior and exterior Tenant signs are to be powered by the Tenant panel. Routing of electrical conduit from the panel to a junction box at the Tenant sign shall be concealed and approved by the Landlord in advance.
- Motors shall be designed to latest NEMA Standards.
- Tenant tie-in to the base building fire alarm system is required.
- All electrical work shall be installed so as to be readily accessible for operating, servicing, maintaining, and repairing. All conduit shall be concealed where possible. Exposed conduit shall be in straight lines parallel with or at right angles to, column lines or beams and separated by at least 3 inches from water lines whenever they run alongside or across such lines. Hangers shall be fastened to steel, concrete, or masonry, but not to piping. Hangers and support systems are an integral part of the visual environment. All hangers and supports exposed to public view must be shown in detail on plans submitted to Landlord for approval of appearance. All hangers must be uniformly spaced and neatly installed with no excess material beyond what is required for the support function. Select accessories and hardware with a smooth, neat finished appearance. Paint all exposed conduit hangers to match the adjacent finishes.
- Grounding shall consist of copper conductors in conduit with bolted connections. Grounding and bonding shall comply with NEC and IEEE Green Book. All metallic raceways shall be grounded.
- Manual motor starters with overload protection may be used for fractional horsepower motors. Three-phase starters shall be provided with overload and under voltage protection in each phase. Automatic motor starters shall be used for integral horsepower motors. Combination starters, when used, shall contain fusible switches. Reduced voltage starters shall be used for all motors 100 HP and larger. All automatic motor starters shall have a control transformer, HOA switch and red pilot light. Electronic motor starters must limit total harmonic distortion fed back into line to 20% or less.
- Tenant's engineer shall refer to Tenant Design Criteria, for specific light fixture and signage lighting requirements. Fluorescent fixtures, where permitted, shall be either rapid start or slimline T8 or compact lamps. All ballasts for fluorescent lamps shall be the electronic high efficiency type with maximum 20% total harmonic distortion fed back into line. Preheat and/or trigger start fixtures shall be used only in special applications requiring lamps less than four feet in length. Provide minimum lighting levels required by Health Department and other agencies.
- No appurtenances (including light fixtures, antennas, satellite dishes, signs, etc.) shall be affixed to the exterior walls or roof of Landlord's building without Landlord's prior written approval.



> DEMAND LOAD / DATA / LIGHTING

DEMAND LOAD REQUIREMENTS

The Tenant's estimated maximum demand load shall be based on the summation of:

- 100% of the air conditioning and ventilation load (the greater load of cooling or heating); plus
- The percentage of the connected load for kitchen equipment, including refrigerators, freezers, etc.; in accordance with the NEC, plus
- 100% of the connected load for electric water heaters, plus
- 100% of connected lighting load (based on lamp wattage for incandescent lamps and watts input to the ballast for fluorescent lamps), plus
- 65% of the connected load of all appliances not mentioned above.
- 100 % of illuminated signs, base equipment connected load on nameplate.
- Receptacles per NEC.

Load data indicated above shall be listed on the Tenant electrical plans or elsewhere in submissions to Landlord.

DATA AND COMMUNICATIONS – INSTALL AND PROVIDER REQUIREMENTS

Telecommunications service is provided and administered throughout the Center by Granite Grid. The service includes a dedicated concierge customer service representative for each Tenant, high-bandwidth service (tailored to suit Tenant demand), centrally coordinated installations, moves and repairs.

- **ACCOUNT SETUP AND SERVICE INSTALLATION** is the Tenant responsibility to coordinate direct through Granite Grid. Other data providers are not permitted at this property as they do not have an access agreement in place. ****It is highly recommended to coordinate service install a minimum of 4 weeks in advance.**
- **TELEPHONE DEMARC WORK** must be performed by Landlord's approved telephone subcontractor.
- **TELEPHONE SERVICE** is the Tenant responsibility to contact the local Telephone Company and install within their premises.

LIGHTING – SYSTEM REQUIREMENTS

- **LIGHTING IN TENANT SPACE** is the Tenant's responsibility. The Tenant will not install any lighting outside the Tenant's space with the exception of Mall required standard lighting at back doors. These fixtures shall be photo cell controlled.
- **LIGHTING SCHEDULE** is required for review in conjunction with a reflected ceiling plan.
- **TIME CLOCK** is required to control display window lighting and be on during the hours the Shopping Center is open.
- **DISPLAY WINDOW LIGHTING** at the ceiling must be glare-free and at approved levels at the storefront glass line and not hang down below the top of storefront glass.
- **RECESSED INCANDESCENT DOWN LIGHTS** are permitted.
- **DECORATIVE LIGHTING FIXTURES** for storefront illumination, such as luminous ceilings, chandeliers, pendant or wall units or clear type glitter strips are permitted if approved by Landlord. No strobe, spinner or chase type lighting shall be used.
- **CODE REQUIRED LIGHTING** such as exit, emergency and night lights must be provided throughout.
- **SALES AREA FLUORESCENT LIGHTING** must be recessed and must use metal parabolic louver type lenses with a minimum of 18 cell configuration for a standard 2' x 2' fixture. Bare lamp fluorescent or fluorescent fixtures with acrylic prismatic lenses may be used only in concealed areas or stock rooms.
- **TRACK LIGHTING** may be used if the track is painted to match the ceiling color.
- **LIGHTING CONTROL SYSTEM** is the Tenant responsibility, including connection to the Building Management system and connection to the Fire Alarm system.



> LIFE SAFETY > SPRINKLER / FIRE ALARM / EGRESS

SPRINKLER SYSTEM REQUIREMENTS

- **SPRINKLER MODIFICATIONS** are the Tenant's responsibility, designed and installed in accordance with NFPA 13.
- **SPRINKLER DESIGN AND INSTALLATION** must be performed by the mall required sprinkler contractor.
- **SPRINKLER HEADS** in all finished areas must be semi-recessed or recessed quick response type.
- **DESIGN CONTROL AREA** requires flush mount heads.
- **PIPING** must be as close to walls and as high to underside of roof framing as possible.
- **LANDLORD NOTIFICATION** is required in writing at least 24 hours in advance of making any modifications to the sprinkler systems. Contractor must notify the fire department and any alarm monitoring company for verification that the system is fully drained. The contractor must notify the Landlord when the system is back on line.

FIRE ALARM REQUIREMENTS

- **FIRE ALARM DETECTION SYSTEM** is a Tenant responsibility to provide within the Tenant space as an extension of the Landlord's building-wide addressable fire alarm system.
- **FIRE ALARM INSTALLATION** must be performed by the Landlord's designated contractor.
- **FIRE ALARM TIE-IN** to the building wide addressable system must be performed by the Landlord's designated contractor.
- **OCCUPANT NOTIFICATION** must be provided within tenant spaces (on a tenant-by-tenant basis) that exceed the Code's thresholds based on the occupancy classification of the individual tenant space.

EGRESS REQUIREMENTS

- **FIRE BARRIER FROM ADJACENT SPACE** must be separated by at least 1-hour fire barriers with 60 minute opening protectives.
- **FIRE BARRIER FROM EXIT STAIR DISCHARGE** must be separated by 2-hour fire barriers with 90 minute opening protectives.
- **AUTOMATIC SPRINKLER SYSTEMS** must protect passageways.
- **SMOKE DETECTION SYSTEM** must protect passageways.
- **GAS PIPING**, if distributed along the exit passageway routes, will be separated from the exit passageway by fire rated construction and will not be considered to be located within the exit passageways.
- **ALLOWED UTILITIES** in exit passageways are limited to; Electrical wiring (no higher than 480 volts phase-to-phase and 277 volts phase to-neutral) in electrical conduit, Low-voltage wiring (security, music, telephone, data, etc.), enclosed junction boxes, Fire alarm equipment and wiring, Noncombustible piping, and Mechanical ductwork.
- **PROHIBITED UTILITIES** in exit passageways include; Electrical equipment such as panels, switchgear, and transformers, Grease traps, and Natural Gas piping.



> PLUMBING > SYSTEM REQUIREMENTS

SYSTEM OVERVIEW

Tenant shell spaces are typically provided a domestic cold water line and sanitary line stubbed into the space.

The following criteria must be followed during the design and construction of the Tenant space:

SYSTEM REQUIREMENTS

Tenant working drawings must include a plumbing riser diagram (if applicable) for sewer and water lines, complete with all cleanouts, pipe sizes, connection to existing Landlord lines, materials, and specifications, etc.

PIPING REQUIREMENTS

All piping systems must be compatible with the type of materials used by the utility and Landlord, and shall comply with the following requirements:

- Drainage, vent pipe and fittings for above grade use shall be either PVC – DWV with glued joints or service weight, hubless cast iron with rubber sealing sleeve and stainless-steel coupling joints with stainless steel clamps and bolts. Below grade use service weight, bell and spigot cast iron or gasketed joints.
- Water piping shall be Type L copper tubing, seamless drawn, hard copper with plain ends ASTM B88. Fittings shall be wrought or cast copper with socket ends for lead-free solder.
- Gas Piping shall be black steel pipe schedule 40 seamless with threaded connections.
- No plumbing is to be run through building chases or cut into the exterior walls.
- Condensate drains for roof top units shall be PVC pipe thermally insulated. Piping shall be restrained to appropriately sized wood blocking set into roof cement. Blocking shall allow for movement due to thermal expansion. Piping shall discharge at area drains. The routing of the piping shall be such to avoid trip hazards on the roof.
- All openings through structurally supported slabs must be core-bored, sleeved, grouted, sealed and made water and fireproof. Sleeves, except for water closets, janitor sinks and floor drains, must extend at least two inches (2") above the finished floor. Landlord must approve the location of all floor openings in writing. Waterproofing must be inspected and approved by the Landlord before any flooring material is installed. The Tenant is responsible for taking whatever measures are necessary (including but not limited to those measures prescribed by the Landlord in the exercise of its reasonable judgment) to assure that core-boring will not damage Landlord's structure, conduits, etc. The costs of such tests or repair of any damage will be borne by the Tenant.

PIPING SUPPORT REQUIREMENTS

Pipe is to be supported securely from hangers as follows:

- Pipes supported from steel structure shall be supported from steel beams and joists with approved clamps and other structural attachments.
- In areas with concrete flat slabs and concrete on metal deck, inserts, self-drilling anchors, or powder driven anchors will be allowed.
- No pipe hangers will be supported from the metal roof deck or base building utilities.
- Hangers shall not pierce piping insulation vapor barrier.
- All steel hangers, rods, beam clamps, etc. exposed to public view shall be painted to match adjacent finishes. Appearance and spacing of hangers exposed to public view, are important aspects of the final visual environment. Specific details of support methods and location of hangers must be indicated on drawings submitted to Landlord for review and are subject to Landlord's approval. All hangers must be evenly spaced and grouped as much as possible with supports for other trades to minimize visual clutter in the upper portions of all spaces exposed to public view. Support systems must be neat and workmanlike, and free of extra length of support rods below the supported member. Hardware and accessories must be selected with a smooth finished appearance for the completed support assembly. Hangers exposed to public view shall be of the clevis or trapeze type, complete with bolts, rods and nuts. Minimum hanger rod diameter shall not be less than, and maximum spacing of supports for steel and copper horizontal piping must not be greater than, the values in the latest issue of the ASHRAE Handbooks. Cast iron pipe must be supported at least every five feet, and at every joint and fitting. Cast iron pipe branches must have hangers four-foot on center maximum. Where required to meet minimum spacing of hangers, Tenant's plumbing contractor is responsible for installing additional intermediate structural supports.
- Provide cast brass or chrome escutcheons with setscrew, deep type, to cover sleeves or of a size to cover fitting projections. Provide escutcheons for all exposed piping through walls, floors, and exposed ceiling.



> SYSTEM REQUIREMENTS

VALVE REQUIREMENTS

Valves shall be designed and installed to meet the following requirements:

- All valves for domestic water to be 125 psi test all bronze wedge gate valves or line size quarter-turn ball valves installed in the proper orientation.
- All valves shall be accessible for ease of operations.
- Tenant shall provide a main water shut of valve located at eye level in a wall behind a labelled access door. Locate in or near employee restroom as designated by Landlord.

RESTROOM REQUIREMENTS

In some cases, a restroom may be existing. In the event a restroom is not existing or additional restrooms are required, the following criteria applies, as applicable.

- Flush valve toilets are permitted providing the Tenant has verified that the water line serving the Premises is sized to handle the requirements. Increasing the size of water service to the Premises must be approved by the Landlord. The cost of new water piping, meter, and increased utility deposit are Tenant costs.
- Plumbing vent shall be routed to the roof by the Tenant. Roof penetrations shall be cored and approved in advance by the Landlord.
- The Tenant is required to install waterless urinals in tenant restrooms when urinals are used.
- Low-Flow water closets using 1.6 GPF or less gallons per flush will be installed in all tenant spaces.
- Operation sensors and low-flow heads using 0.5 GPM or less in lavatories.

FOOD OPERATIONS REQUIREMENTS

- Grease interceptors are required for all food preparation areas and must be vented as required by the jurisdictional authorities or health department.
- Interceptors shall be furnished and installed by the Tenant within the premises. Tenant shall be responsible for the proper care, cleaning, and maintenance thereof.
- The grease trap shall be designed and vented in accordance with the Plumbing Code. Tenant shall provide routine maintenance including cleaning and emptying of the grease trap and grease waste plumbing piping and any other regular maintenance on at least a quarterly basis.
- Garbage disposals are not permitted.
- Floor drains must be provided where required by code. All floor drains installed in toilet rooms must have acceptable means to maintain a water seal in the trap.



> MECHANICAL > GENERAL DESIGN REQUIREMENTS

Landlord will furnish and install an all-electric roof top mounted single packaged heating and cooling unit sized to approximately one ton per 350 square feet of space. Landlord will provide a roof curb and all associated support framing and roof work. An empty conduit will be provided from the Tenant's premises to the RTU. Power to the unit and startup of the unit are Tenant's responsibility.

GENERAL REQUIREMENTS

Tenant is responsible for the design of the Tenant's HVAC duct and temperature control system. All calculations shall be in accordance with the latest edition of the ASHRAE Handbooks, all applicable codes and regulations, and good engineering practice. All calculations shall be certified by a New York Registered Professional Engineer and the results submitted to Landlord for approval.

- Field verification of existing HVAC RTU information is the responsibility of the Tenant.
- If additional rooftop units are needed to meet the Tenant's tonnage requirements or if existing equipment is of a condition that it may not be reused, new equipment is to be supplied and installed by the Tenant at the Tenant's expense. Removal and disposal of old equipment is by the Tenant at the Tenant's expense.
- Rooftop HVAC equipment shall be located directly above the Tenant Premises or as approved by the Landlord. Tenant shall install all other HVAC equipment within the Tenant's premises including air handling equipment for split systems, controls, ductwork, fire dampers where required, electric connections, electric duct heat, and balancing. Tenant shall provide access panels at all equipment for service access.
- Outside air ventilation when needed shall be provided through the roof at a point above the Tenant's space. All design of the ventilation system and installation shall be by the Tenant at the Tenant's sole expense.
- Tenant's rooftop units shall be selected based on the cooling and heating load requirements of the space served.
- Tenant's HVAC system shall be a stand-alone system.
- Tenant shall engage the services of a certified air balance contractor to adjust and completely balance Tenant's HVAC system. Tenant shall provide to Landlord a copy of the certified balance report, showing static pressures, fan motor RPM, motor current, supply air, outside air and exhaust quantities as part of the closeout package.

NOISE REQUIREMENTS

- All equipment installed by Tenant shall be provided with vibration isolators, sound traps, duct lining, acoustic housings, acoustical louvers and other noise and vibration control apparatus required to limit intrusion into adjacent spaces accordingly:
 - Intrusive noise levels transmitted to adjacent spaces shall not exceed NC-25 when measured in the adjacent tenants' spaces.
 - Tenant equipment noise emitted to the exterior shall not exceed 45 dBA. At any time within the first six months of occupancy or within the first six months after installation of any new equipment which produces noise and vibration, the Landlord may request a test by an acoustical consultant of its choice to verify compliance with the above minimum acoustical requirements. Should the Tenant be in compliance, the Landlord will pay the costs of the testing. Should the Tenant not be in compliance, Tenant will pay the costs of the initial testing, shall make whatever changes are required to bring the installation into compliance, and shall pay the costs of all subsequent testing by an acoustical consultant approved by the Landlord to verify compliance.



> GENERAL & EXHAUST REQUIREMENTS

CEILING MOUNT REQUIREMENTS

Ceiling mounted fan units, piping, heaters, fans, and ductwork may be attached to the Landlord's structure, subject to the following:

- Installation must be designed by or approved by Landlord's structural engineer, at Tenant's expense. Tenant shall submit equipment weights for approval.
- Reinforcing building structure or components shall be performed by Landlord's approved contractor at Tenant's expense.
- Ductwork and all other Tenant construction must be designed to clear any interior roof leaders, downspouts, sprinkler, or gas lines in the space.
- No openings for fans, vents, louvers, grilles, or other devices shall be installed in any demising partition, exterior wall, or roof without Landlord's prior written approval. All roof openings, blocks and flashing must be done by the Landlord's approved roofing contractor at the Tenant's expense.

DUCTWORK REQUIREMENTS

- The Tenant ductwork shall be fabricated from galvanized sheet metal and be in compliance with all SMACNA Standards. All duct branches off of the main trunk line shall be installed with volume dampers to allow for proper balancing. If the dampers are located above an inaccessible ceiling, a remote operator or ceiling access panel shall be installed.
- Flexible ductwork shall be factory insulated and shall only be used for tie-ins from the trunk line or branch duct to the air distribution devices. Flexible ductwork shall be limited to a maximum length of 6 feet.
- Air distribution devices shall be located per the engineered drawings and to ensure proper air flow. Air distribution devices shall be of steel or aluminum construction.
- All supply, return, and outside air ductwork shall be externally insulated, except where ductwork is internally lined, with minimum R-3.2 insulation. All joints and seams of the insulation shall be stapled and sealed.
- Fiberglass duct is not permitted.

RETAIL EXHAUST REQUIREMENTS

To meet exhaust requirements the Tenant shall provide rooftop equipment above its space and penetrate the roof to its ceiling space. The exhaust fan and associated ductwork is provided by the Tenant.

- Toilet exhaust is vented to the roof.
- Relief of any excess outside air shall be vented to a Tenant exhaust system.
- All odorous or otherwise unacceptable air as determined by Landlord shall be removed by means of a ducted exhaust system with a centrifugal exhaust fan ducted to the outside of the building at the roof.
- Air should not flow from the food preparation areas to dining and waiting areas or to other portions of the Landlord's building.



> KITCHEN EXHAUST REQUIREMENTS

KITCHEN EXHAUST REQUIREMENTS

- Tenants furnish, install, and maintain their own individual kitchen exhaust and make-up air systems, constructed, and installed in accordance with all other applicable codes and regulations. Kitchen exhaust fans shall be located on the roof in locations designated and approved by the Landlord. All exhaust systems must be electric motor drive, connected and controlled from the Tenant's space. Tenant shall provide conduit from Tenant space to the roof for this purpose. The routing path of the conduit must be approved by the Landlord.
- Kitchen hoods shall bear evidence of UL and NSF listing. Kitchen hoods must incorporate UL listed fire damper for supply air penetrations in accordance with NFPA 96.
- Hoods must be capable of removing at least 90% of the grease contained in the exhaust air. Grease removal filters shall be provided with access panels. The Tenant shall be responsible for cleaning filtration equipment on a timely basis. The hood must be designed for proper capture taking into account the type of cooking, in a manner accepted by a nationally recognized standard.
- The Tenant shall furnish, install, and maintain in proper working order, a UL listed wet chemical fire-extinguishing system to protect all kitchen hoods above cooking areas and, if required, extending into ductwork. Fire extinguishing system must be approved by the Landlord and meet the requirements of NFPA 96 and local codes.
- Kitchen exhaust ductwork shall be installed in a fire rated shaft provided by the Tenant. Location of the shaft and roof penetrations must be approved by the Landlord at the time of the drawing review. Duct work shall be constructed of 16-gage minimum thickness carbon steel. Continuously weld all longitudinal and transverse joints. Where applicable, ducts shall be enclosed as required by NFPA 96 and local codes. Ducts need not be insulated when they are the only duct within the fire rated shaft and there is 6" clear to the shaft. When ducts serving other types of equipment are located within the same shaft, steps may be required by code to assure the fire separation between the systems. Exhaust ducts located outside the Tenant space must be enclosed in a two-hour rated assembly up to the shaft.
- Horizontal ducts shall be sloped and reservoirs with cleanout doors shall be provided by Tenant in accordance with the International Mechanical Code (IMC) at 20' - 0" on centers, or as otherwise required by code. The bottom edge of the cleanout door shall be not less than 2 inches above the bottom of the duct. Every run shall have at least one cleanout door. Provide a cleanout door and grease drain at the base of each vertical section of the kitchen exhaust duct. Cleanout doors and frames shall be fabricated of the same gage metal as the duct. Provide 1/8inch thick high temperature gasket, approved for use on kitchen exhaust ducts, between frame and duct and between door and frame.
- Tenant hoods will operate with direct connected outside air supply from the Tenant make-up air system and the conditioned space, in conformance with all applicable codes. The direction of air flow shall always be from the common area into the Tenant space. For spaces permitting smoking, air must flow into the Tenant space across the entire area of any openings leading outside the demised premises.
- Make-up air ductwork shall be fabricated from galvanized sheet metal in accordance with the standards of the Sheet Metal and Air Conditioning Contractors National Association of America, latest edition and shall be insulated with 1-1/2" fiberglass or equal.
- Ductwork for dishwasher steam appliance and oven exhaust shall be fabricated rectangular low-pressure stainless steel or aluminum ductwork of at least 20 gage minimum thickness. Ductwork shall be properly pitched to drain to the hood connection and joints shall be fully sealed to prevent leaking.
- Tenant ductwork shall be shown on the plans, coordinated with base building construction, and any code required fire dampers shall be installed at the Tenant's expense.
- Air balance of any exhaust and makeup systems shall be the responsibility of the Tenant, and Tenant shall furnish Landlord with a copy of a certified air balance report.
- Tenant shall operate the exhaust and make-up system during all hours of cooking operation.



> SUB SLAB & VAPOR BARRIER > DETAILS

All saw cutting, trenching and excavation must adhere to the guidelines for the sub-slab depressurization system. If penetrated, the vapor barrier must be repaired and maintained to all applicable manufacturer guidelines and details as shown in this section.

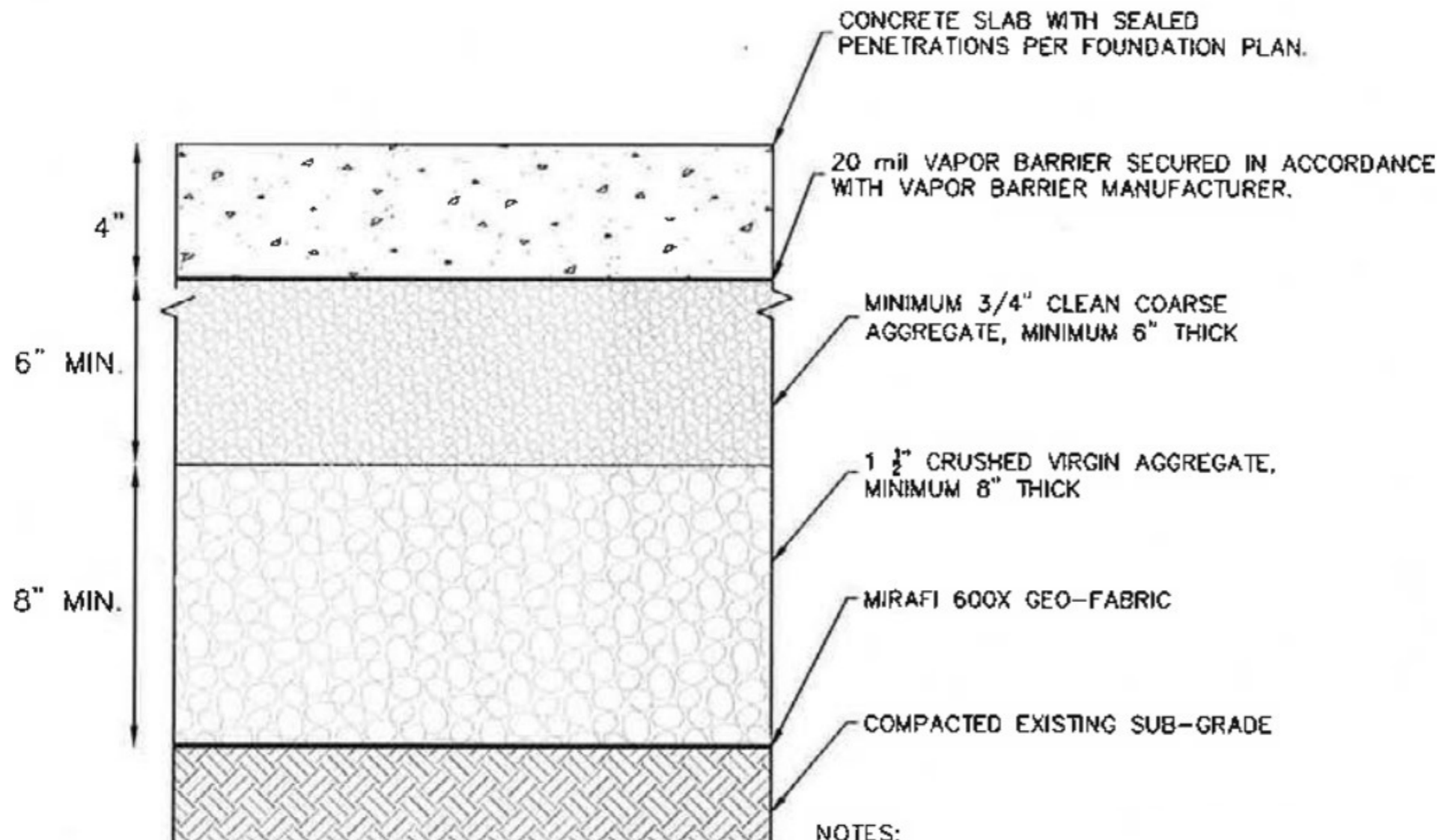

1. THE VAPOR BARRIER SHALL BE REPAIRED AND MAINTAINED IN ACCORDANCE WITH ALL APPLICABLE MANUFACTURER GUIDELINES AND DETAILS.
2. BUILDING SLAB CROSS SECTIONS WERE COMPILED FROM BOTH LANGAN SSDS DESIGN AND RTKL SECTIONS PROVIDED ON 25 JULY 2013.



> SUB SLAB & VAPOR BARRIER > UNDER SLAB INSTRUCTIONS

UNDER-SLAB INSTRUCTIONS:

FIGURE 1: UNDER-SLAB INSTALLATION

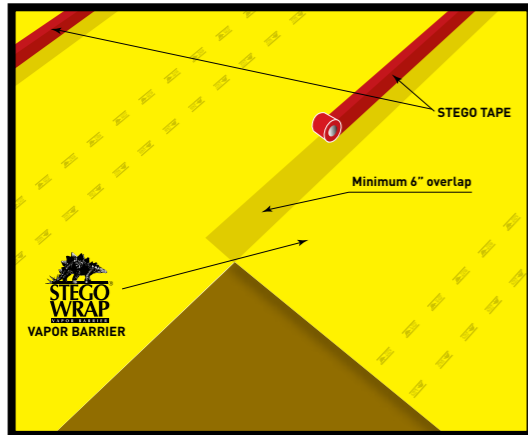

FIGURE 2a: SEAL TO SLAB AT PERIMETER

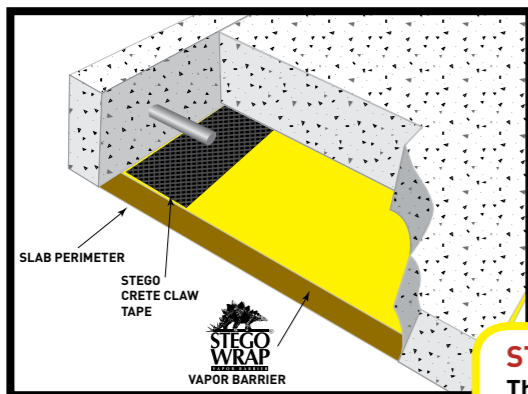
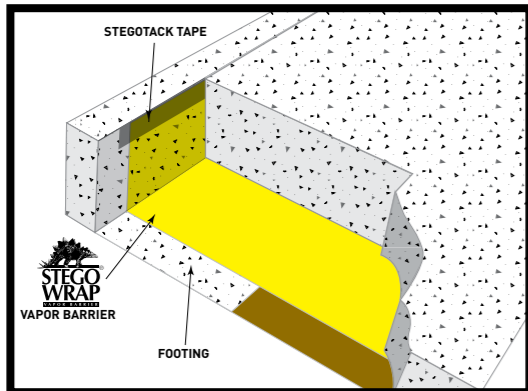

FIGURE 2b: SEAL TO PERIMETER WALL



1. Stego Wrap can be installed over an aggregate, sand, or tamped earth base. It is not necessary to have a cushion layer or sand base, as Stego Wrap is tough enough to withstand rugged construction environments.
2. Unroll Stego Wrap over the area where the slab is to be placed. Stego Wrap should completely cover the concrete placement area. All joints/seams both lateral and butt should be overlapped a minimum of 6" and taped using Stego® Tape.
NOTE: The area of adhesion should be free from dust, dirt, moisture, and frost to allow maximum adhesion of the pressure-sensitive tape.
3. ASTM E1643 requires sealing the perimeter of the slab. *Extend vapor retarder over footings and seal to foundation wall, grade beam, or slab at an elevation consistent with the top of the slab or terminate at impediments such as waterstops or dowels. Consult the structural engineer of record before proceeding.*

SEAL TO SLAB AT PERIMETER:*

NOTE: Clean the surface of Stego Wrap to ensure that the area of adhesion is free from dust, dirt, moisture, and frost to allow maximum adhesion of the pressure-sensitive adhesive.

- a. Install Stego® Crete Claw® Tape on the entire perimeter edge of Stego Wrap.
- b. Prior to the placement of concrete, ensure that the top of Stego Crete Claw Tape is free of dirt, debris, or mud to maximize the bond to the concrete.

STEGO LABOR SAVER!

- This method not only complies with ASTM E1643, but it also:
- reduces labor compared to other perimeter sealing techniques.
 - can be used even without an existing wall or footing, unlike alternatives.

OR SEAL TO PERIMETER WALL WITH STEGOTACK® TAPE:*

- a. Make sure area of adhesion is free of dust, dirt, debris, moisture, and frost to allow maximum adhesion.
- b. Remove release liner on one side and stick to desired surface.
- c. When ready to apply Stego Wrap, remove the exposed release liner and press Stego Wrap firmly against StegoTack Tape to secure.

* If ASTM E1643 is specified, consult with project architect and structural engineer to determine which perimeter seal technique should be employed for the project.

IMPORTANT: Please read these installation instructions completely, prior to beginning any Stego Wrap installation. The following installation instructions are based on ASTM E1643 - Standard Practice for Selection, Design, Installation, and Inspection of Water Vapor Retarders Used in Contact with Earth or Granular Fill Under Concrete Slabs. If project specifications call for compliance with ASTM E1643, then be sure to review the specific installation sections outlined in the standard along with the techniques referenced in these instructions.



> SUB SLAB & VAPOR BARRIER > UNDER SLAB INSTRUCTIONS

4. In the event that Stego Wrap is damaged during or after installation, repairs must be made. For holes, cut a piece of Stego Wrap to a size and shape that covers any damage by a minimum overlap of 6" in all directions. Clean all adhesion areas of dust, dirt, moisture, and frost. Tape down all edges using Stego Tape (See Figure 3).

FIGURE 3: SEALING DAMAGED AREAS

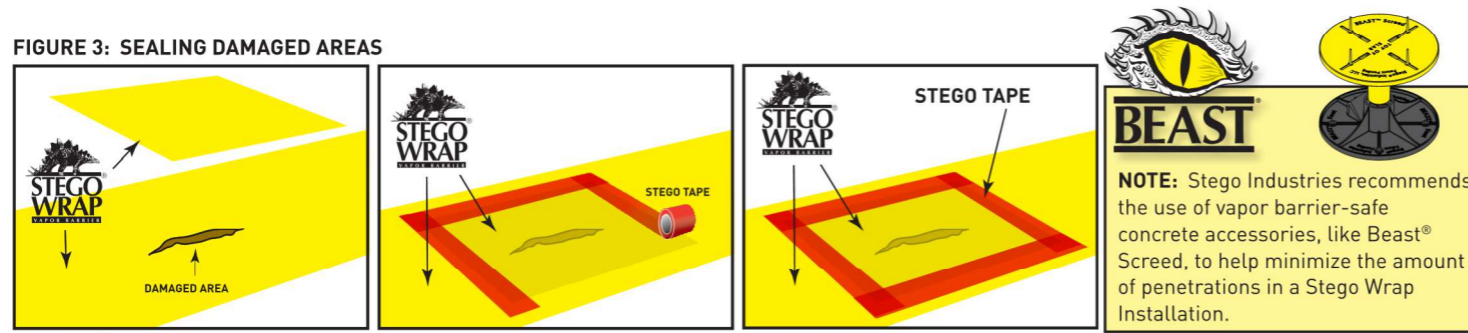

5. **IMPORTANT: ALL PENETRATIONS MUST BE SEALED.** All pipe, ducting, rebar, wire penetrations and block outs should be sealed using Stego Wrap, Stego Tape and/or Stego Mastic (See Figure 4a). If penetrations are encased in other materials, such as expansive materials like foam, unless otherwise specified, Stego Wrap should be sealed to the underlying penetration directly.

FIGURE 4a: PIPE PENETRATION SEALING



STEGO WRAP PIPE PENETRATION REPAIR DETAIL:

- 1: Install Stego Wrap around pipe penetrations by slitting/cutting material as needed. Try to minimize the void space created.
- 2: If Stego Wrap is close to pipe and void space is minimized then seal around pipe penetration with Stego Tape and/or Stego Mastic. (See Figure 4a)
- 3: If detail patch is needed to minimize void space around penetration, then cut a detail patch to a size and shape that creates a 6" overlap on all edges around the void space at the base of the pipe. Stego Pre-Cut Pipe Boots are also available to speed up the installation.
- 4: Cut an "X" the size of the pipe diameter in the center of the pipe boot and slide tightly over pipe.
- 5: Tape down all sides of the pipe boot with Stego Tape.
- 6: Seal around the base of the pipe using Stego Tape and/or Stego Mastic. (See Figure 4b)

FIGURE 4b: DETAIL PATCH FOR PIPE PENETRATION SEALING

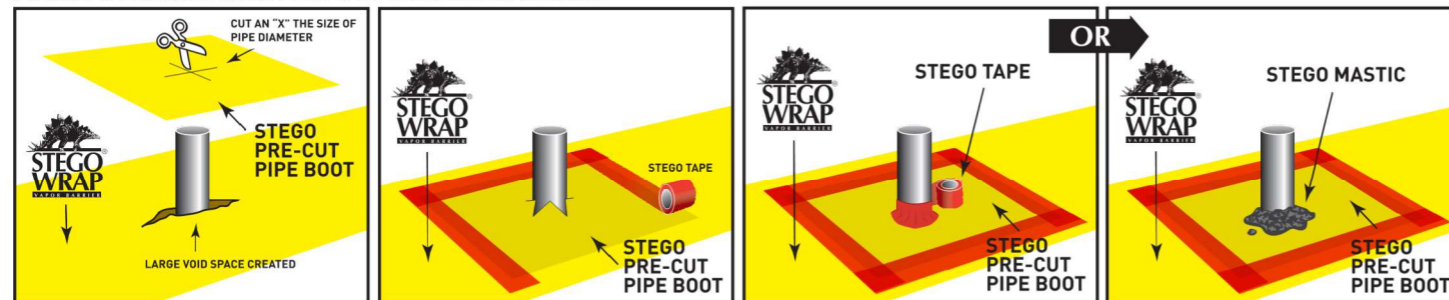

FIGURE 5: MULTIPLE PIPE PENETRATION SEALING



MULTIPLE PIPE PENETRATION SEALING: Multiple pipe penetrations in close proximity and very small pipes may be sealed using Stego Wrap and Stego Mastic for ease of installation (See Figure 5).



> SUB SLAB & VAPOR BARRIER > TRENCH REPAIR

TRENCH REPAIR SCENARIOS

Stego Industries, LLC recommends that Stego Wrap is installed in compliance with the latest version of the prevailing installation standard, ASTM E1643. When applied to trench repair, in most instances the critical aspect is creating the 6-inch overlap required by the standard. The ability to successfully create the proper overlap depends on a variety of factors, most importantly advanced planning. This technical memo demonstrates four potential repair options that may not take into account local building codes or project specific conditions. The following options do not supersede contract documents, and as such, the repair method utilized must be approved by a licensed design professional.

SCENARIO 1 – A FILL COURSE WAS USED

In the event that a fill course was used above the vapor barrier, the following method can be utilized. Figure 1 below shows that with a fill course above the membrane, saw cuts can be made without damaging the vapor barrier.



SCENARIO 2 – ADVANCED PLANNING

If there is no fill course above the vapor barrier and a trench needs to be cut in the concrete, the following method can be utilized to create the 6 inch overlap called for by ASTM E1643:

Cut through the concrete and the vapor barrier and remove a smaller section (6 inches on each side) in the center of your intended trench location as seen in Figures 2A and 2B.

With an understanding of the concrete thickness obtained from the initial cuts, create two more cuts just shy of the full concrete depth at the full width of the intended trench as seen in Figure 2B. Break

FIGURE 2a

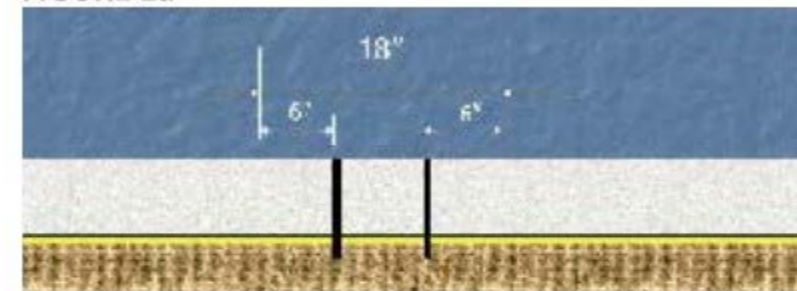

FIGURE 2c

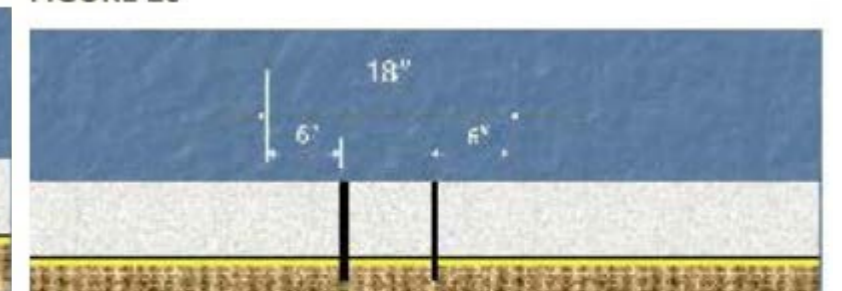

FIGURE 2b

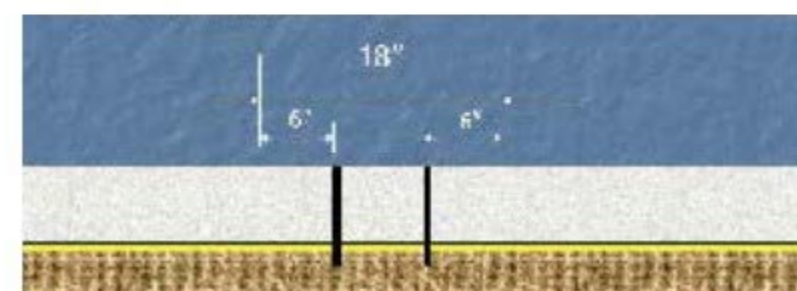
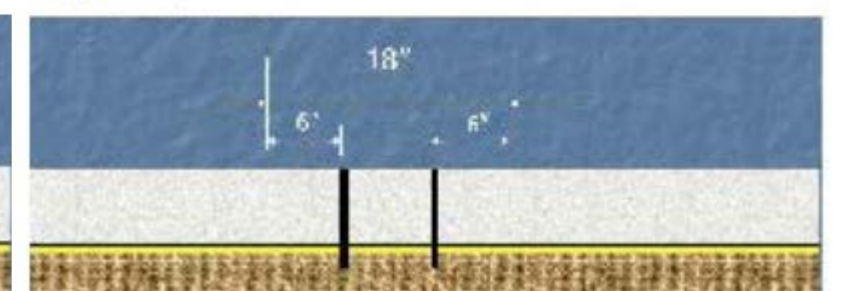

FIGURE 2d



> SUB SLAB & VAPOR BARRIER > TRENCH REPAIR

SCENARIO 3 – NO ADVANCED PLANNING DIG OUT

In the event that the trench has already been cut and 1643 compliance is required by the design professional, the only way we know of to achieve the overlap is to dig out beneath the vapor barrier to expose enough of the membrane for overlapping. Next, tape the repair membrane to the existing vapor barrier with 6 inches of overlap. Finally, fill trench with replacement concrete making sure to fill any voids created. This is not an ideal method as in many cases this is impractical, expensive, or even impossible to achieve. This process is detailed in Figures 3A, 3B, and 3C as seen in Figure 2D.

FIGURE 3a

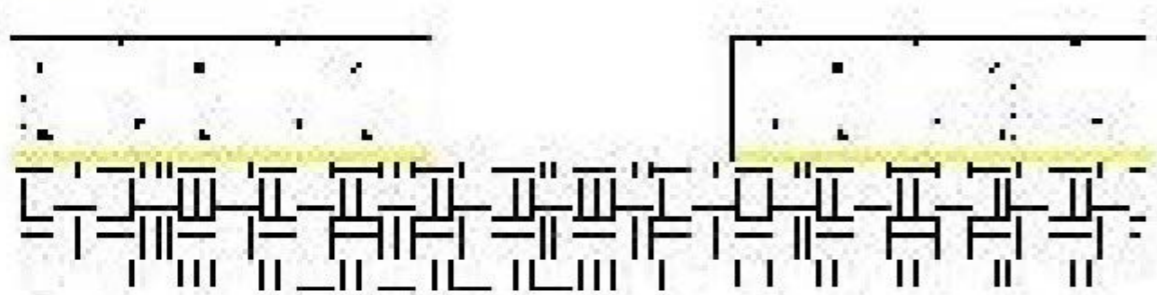

FIGURE 3b

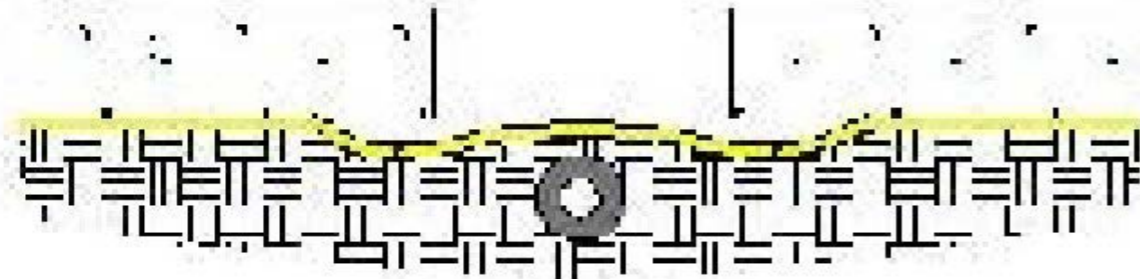
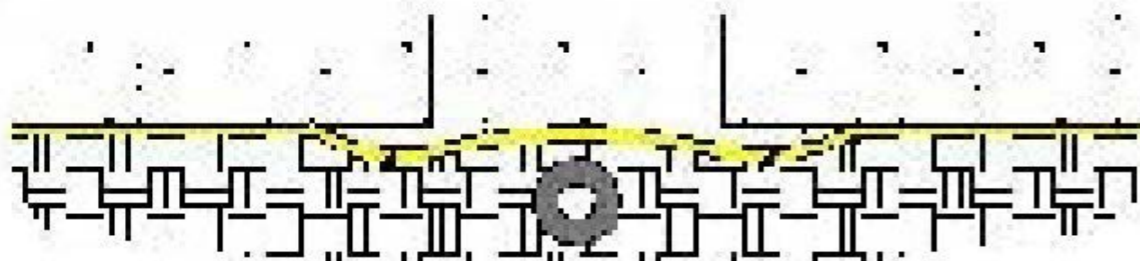

FIGURE 3c



SCENARIO 4 – NO ADVANCED PLANNING PATCH

Although not 1643 compliant, the following method may be the only practical/possible way to detail an already-cut trench. In this scenario, the repair piece of Stego Wrap is cut to fit in the trench and is sealed with either Stego Mastic or StegoTack Tape. By definition, this is not a Stego preferred method due to its non-compliance with ASTM E1643. The method is detailed in the figure below.

FIGURE 3a

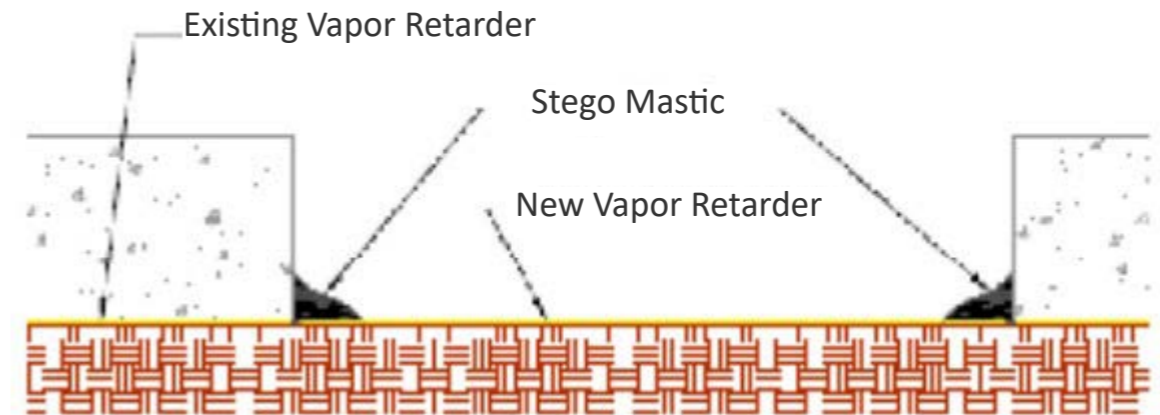

FOOD CRITERIA CONTENT OVERVIEW

2.1

FOOD COURT

DETAILS SPECIFIC DESIGN, SIGNAGE, AND TECHNICAL REQUIREMENTS FOR FOOD COURT TENANTS.

2.2

INLINE COUNTER SERVICE

DETAILS SPECIFIC DESIGN, SIGNAGE, AND TECHNICAL REQUIREMENTS FOR FOOD TENANTS WITH COMMON AREA FACING COUNTER SERVICE AND LIMITED OR NO SEATING.

2.3

RESTAURANTS

DETAILS SPECIFIC DESIGN, SIGNAGE, AND TECHNICAL REQUIREMENTS FOR FOOD TENANTS WITH INTERIOR OR EXTERIOR FACING RESTAURANT SERVICE.

SECTIONS OF INTEREST

- INLINE CRITERIA**
Standard design, technical, and sign requirements in addition to the contents in this section.
- DESIGN INSPIRATION**
Provides design inspirations for visual aesthetics.
- BUILDING DETAILS**
Includes property reference photos and specific Storefront design details.
- PROPERTY INFO**
Includes information on the Property's building codes, area permitting, and required contractors.
- SUBMITTALS**
Outlines requirements on how and what to compile for submittals to the Landlord for design reviews.

This Food Tenant Criteria is specifically tailored to highlight unique technical and design requirements for Tenant's cooking, preparing, and selling food products.

Through the application of the Criteria guidelines, Food Tenants will produce distinctly original designs unique to their brand and the Center. These guidelines are to help maintain a consistent design quality while still allowing each Tenant to achieve a high level of expression and diversity.

The goal is to enhance the shopping experience for our Customer through the quality and artfulness of Tenant design.

This Criteria will often point to the [INLINE RETAIL CRITERIA](#), as several requirements and design concepts are shared.

The Tenant's Architect is encouraged to contact the Landlord's Tenant Coordinator to discuss any specific design intentions prior to commencing design work. The Tenant Coordinator will strive to resolve all outstanding design issues. However, the Tenant Coordinator may, in the best interest of the Center, reject any aspect of the Tenant's design.

If an acceptable design cannot be agreed upon, the Landlord may, at the Tenant's expense, provide an additional concept Storefront design for consideration.



FOOD COURT > CONTENTS

❑ DESIGN

- ❑ STOREFRONT
- ❑ FOOD DISPLAY & PREP / SEATING / QUEUING
- ❑ LAYOUT / SERVICE COUNTER DESIGN
- ❑ STOREFRONT & COUNTER MATERIALS / COUNTER ELEMENTS
- ❑ LIGHTING
- ❑ STOREFRONT CEILING / ROLLING GRILLE / NEUTRAL PIERS & DEMISING WALLS
- ❑ INTERIOR & PREP AREAS

❑ SIGNAGE

- ❑ STOREFRONT
- ❑ MENU BOARD

❑ TECHNICAL

SECTIONS OF INTEREST

- ❑ DESIGN INSPIRATION
Provides design inspirations for visual aesthetics.
- ❑ PROPERTY INFO
Includes information on the Property's building codes, area permitting, and required contractors.
- ❑ SUBMITTALS
Outlines requirements on how and what to compile for submittals to the Landlord for design reviews.

The Food Court Criteria provides key technical information and design requirements to ensure your food service enlivens the consumer experience and interfaces with the Center's food court design.

The Tenant and the Tenant's architect assume the following important obligations:

- Fulfill the intent of the Criteria both in concept and in detail.
- Determine and respond to the actual physical conditions of the Tenant's location.
- Maintain and enhance the high standards of quality established in the construction of the Center.
- Ensure the quality of execution of all design material, finish, and detail concepts in the construction of the Tenant's improvement.
- Provide the required detail at all transitions from Tenant Storefront to neighboring Storefronts, as well as to the base building.



> DESIGN > STOREFRONT

OVERVIEW

Food Courts may include a variety of spaces that are comfortable and stylish, inviting the Customer to come, stay, eat, and enjoy.

The design of each unit, as viewed from the common area, must convey the unique character and sense of identity for each Tenant and also be compatible with the overall Architectural design of the Food Court.

The Storefront design area considers all portions of the Store that are visible to the public, in front of the full height service area partition.

Unique and unexpected storefront design will spark interest to draw in Customers.

Encouraged Storefront design traits include:

1. Use of contrast:
 - a. Mixing modern and traditional design elements.
 - b. Mixing neutrals with colors.
 - c. Blending shiny and matte surfaces.
2. Combining patterns with solids.
3. Embracing unique craft and technology.
4. Using special features, tasteful props, and displays.



> FOOD DISPLAY & PREPARATION / SEATING / QUEUING

FOOD PREPARATION AS THEATRE

When food preparation is visible to the public, the area is required to be designed with a sense of theater.

The need for an authentic, shared, and unique experience has grown over time. Unique experiences are the opposite of one-size-fits-all approach of the “chain”. Tenants that offer a peek into the making of what they sell help include the Customer and make for an authentic experience.

FOOD DISPLAY

- Showcases must reinforce the Tenant’s image and be an integral part of the design within the counter.
- Glass must be tempered or a safety type. Plexiglas is not permitted.
- Showcases shall not exceed 14” above counter and 36” overall width. It shall not be more than 50% of the counter length and located no closer than 48” from the neutral pier.

SEATING

- Tenants shall typically not provide, place, or install any seating, carts, etc. inside or outside the lease premises.
- Select specific areas may include private and bistro style seating. These options are site specific, so discussing early with Leasing and Tenant Coordination is recommended. Design Approval is required for all common area Tenant seating.

QUEUE AREAS

- All food venues must provide a queue layout that allows for the Mall to maintain its code minimum distances for general circulation.
- Stanchions are not allowed. Other indicators for Customer directional flow will be considered.



> LAYOUT / SERVICE COUNTER DESIGN

LAYOUT

Due to the high visibility of the Customer Service Area, particular attention is given to the design review of this area. Service areas, furnishings, display cookery, food prep and cooking areas visible from the Mall common area must meet strict design standards.

- Support rooms and storage shall be concealed from public view.
- A full-height partition wall must separate the Customer Service Area and Prep Area.
- Access to the Prep Area shall be via a self-closing door or between staggered “blind walls”.
- Pass-thru windows with any Customer views into kitchen zone are not allowed.
- Landlord may require that any Storefront setback area shall have flooring compatible in quality, color and pattern to the Mall flooring material.
- All Tenant construction shall be self-supporting from the floor and structurally independent of the Mall fascia and bulkhead structure. Tenant construction may be braced horizontally/laterally to the overhead structure (not to the roof deck) within the Tenant space as depicted on Tenant plans and approved by the Landlord.

FRONT SERVICE COUNTER DESIGN

- The vertical counter face cannot be on one plane. Design must include areas that pop in and pop out to create movement. This can be achieved by recessing a small portion of the counter face by a few inches or can be more dramatic. This can also be achieved by ranging counter heights and taller vertical elements. Taller vertical elements must not block visibility.
- Counter face cannot be all one material. Must incorporate a minimum of two to three different types of material that coordinate well together.
- Vertical elements can include a plasma screen menu board or additional vertical signage.
- Tenant to specify a protective edge at the bottom of the counter.
- The form and materials used for counters shall be designed to be inviting to the public to help lure them to the space.
- The toe kick material must be a minimum of 3” behind the face of the counter.
- All Tenant build out must be contained within the lease line unless specifically noted in this Criteria.
- Counter tops must be “Corian” or similar solid surface materials, metal or stone. Tenant counter and counter tops are to be custom designed and fabricated.
- Plastic laminated countertops are prohibited.
- Maximum counter height is 3’-6”. Counter design, including heights, must comply with all accessibility guidelines enforced by national or local jurisdictions and the Americans with Disabilities Act.
- Sneeze guards shall be used above the front counters as required.

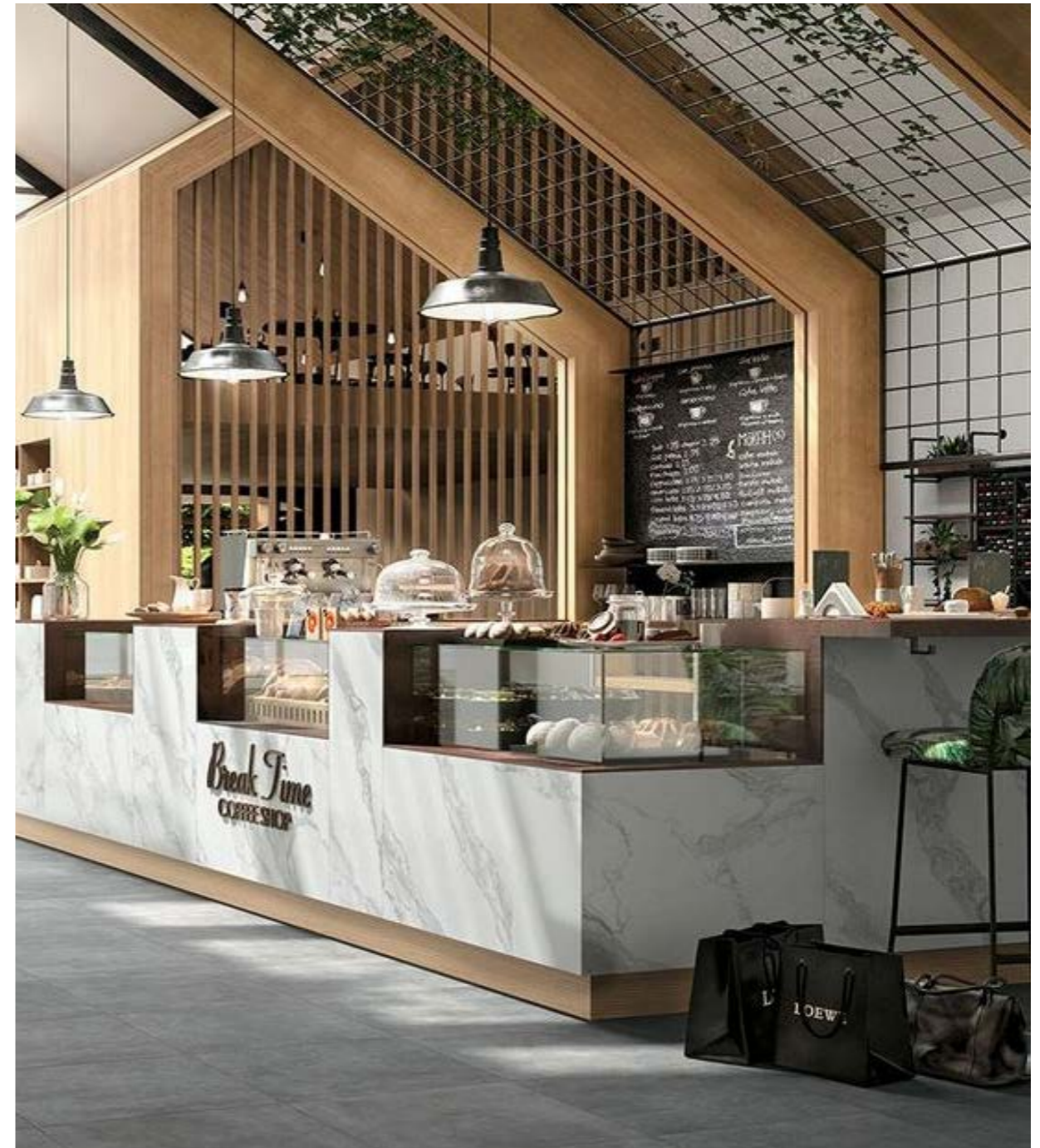

> STOREFRONT & COUNTER MATERIALS / COUNTER ELEMENTS

FRONT SERVICE COUNTER AND STOREFRONT MATERIALS

All finish materials must be backed by a minimum 5/8" solid surface material and may include the following:

- Counter tops must be solid surface materials, metal or stone. Tenant counter and counter tops are to be custom designed and fabricated.
- All stone/tile colors must be integral throughout.
- Metal panels and architectural hardware shall have a professional and durable finish.
- Color anodized, baked painted or antique finish
- Wood veneers and weathered or distressed wood (submit specification for approval)
- Resin panels such as 3-Form products
- Back-painted tempered glass panels
- Glass tiles

Finish materials shall NOT include the following materials:

- 4"x4", 6"x6", 12"x12" glazed tiles
- Shingles or boards
- Plastic laminate
- Faux or plastic formed brick, block or stone
- Clear anodized aluminum
- Other materials as deemed unacceptable by Landlord

COUNTERTOP ELEMENTS

- Cash registers must be recessed so that they extend no more than 9" above the counter top.
- Condiment and utensil displays or dispensers must be fully recessed into the counter.
- Fully recessed counter-top trash receptacles (for straw wrappers, etc.) must be provided near the condiment and utensil displays.
- Tray rails, if used shall be integrated into the counter design and be contained within the lease line.
- Drink dispenser and other utilitarian kitchen equipment may not be placed on the front counter.
- Employee access through the counter front is not permitted. Back counters visible to the public must be built in units with a recessed base detail.



> LIGHTING

LIGHTING

- Tenants must light both their Storefront as well as the countertop.
- Lighting on architectural elements and menu boards are also required.
- Recessed down lighting must be provided at all gypsum board ceilings visible to customers. BK Lighting MC-48-xxx-9-11-B or approved equal by Lumiere. Lamps are to be 50 PAR 20/H/SP.
- Down lighting or pendant lighting is required at the front counter to provide a more intimate and decorative atmosphere while highlighting the counter top and merchandise presentation. Fixtures to be supplied and installed by Tenant to Landlord specifications. Other track lighting may be considered provided that it is not visible from the public area.
- Fluorescent lights are prohibited in all areas visible to the public. They are however, permitted in areas not visible to the public.



> STOREFRONT CEILING / GRILLE / NEUTRAL PIERS & WALLS

STOREFRONT CEILING

- Suspended ceiling of gypsum board (hard lid) is required in Customer areas. See specific zone area for additional requirements.
- Tenant must provide a reflected ceiling plan indicating any and all Tenant lighting, suspended design elements and signage for Landlord approval.
- Ceiling access panels, where required must be depicted on the Tenant's plans, approved by Landlord and be provided at Tenant's expense.
- Allow for access to all structural mechanical, plumbing, electrical, telephone and fire protection systems including all junction boxes, switches, valves, etc. and other equipment for purposes of servicing, and maintaining this infrastructure.

ROLLING GRILLES

- Rolling grilles are not allowed.

NEUTRAL PIERS AND DEMISING WALLS

- The Customer Service Area shall address the full opening width, abutting the Neutral Walls and Neutral Knee Walls on each side of the leased space and extending full height to the Mall soffit.
- Mall structural columns, excluding those treated as neutral piers, located either within the Storefront Zone or along the store frontage, must be integrated into the store design unless otherwise directed by Landlord.
- Special condition neutral walls may be low and extend back from the face of the lease line. This condition increases visibility into the store, however, it requires close coordination with the Tenant Coordinator in the design process.



> INTERIOR AND PREP AREA

Kitchen areas, storage, dish areas, and any other areas not visible to the public must meet the following design requirements:

LIGHTING

Lighting may include, but is not limited to:

- 2' x 4' lay-in surface-mounted fluorescent light fixtures.
- Any fixture allowed by code necessary for food preparation.

FLOORING

- The entire Lease Premises shall be completely and properly sealed using a 'Dex-o-tex' NEOBOND II Fracture Resistant Membrane Waterproofing or equal membrane type sealer approved by Landlord, prior to the installation of any finished flooring material.
- The membrane must be turned up all perimeter Storefront walls, counters and surfaces a minimum of 24", to protect the adjacent Tenants and Mall common areas. Then, either FRP (prep area only), or tile is to be installed up to at least 4'.
- Tenant to submit detail to Landlord for approval prior to installation.
- Tenant shall furnish and install floor tile over waterproof membrane throughout the entire premises.
- The finished floor must be sloped to the Tenant installed floor drains.

Allowed flooring materials include:

- Quarry tile
- Porcelain ceramic tile

Prohibited flooring materials include:

- Vinyl
- Glazed ceramic tile
- Carpet
- Any other material deemed unsuitable by the Landlord

CEILING

- 2' x 4' drop-in panels with an approved finish shall be permitted in storage areas so long as they are not visible to the customers.

WALLS

- All walls in the Prep Area must be of a durable, non-porous, washable surface as required by health codes.

EXIT DOORS

- All exit door specifications, hardware, door handles, recess dimensions, etc. shall be per Landlord Criteria and conform to local codes and ordinances.



> SIGNAGE > STOREFRONT

Food Court Tenant's primary Storefront sign must be creative, imaginative and incorporated into the overall Storefront design.

- Sign must be proportional to overall elevation. Landlord will review sign size on an individual basis. Sign length must not be more than 1/3 of the overall storefront length.
- Sign must complement overall design and add visual interest.
- Power must be concealed.
- 12" max letter height will be enforced.
- Back of sign must be finished.

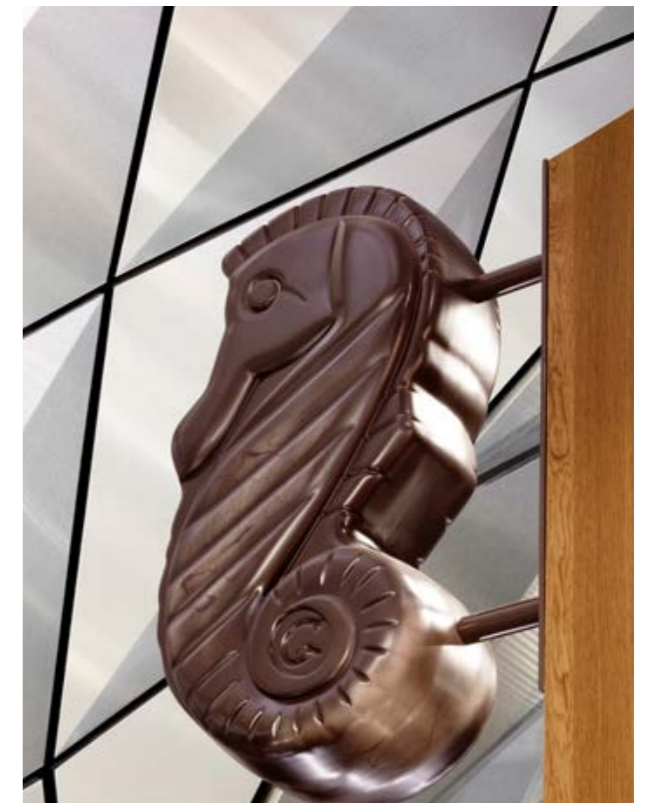

> MENU BOARDS

Menu board applications must be a part of the overall store design. We strongly encourage using a graphic designer to create your boards.

DESIGN REQUIREMENTS

The following requirements must be used when designing your menu boards:

- All menu boards must be submitted to the Landlord for review and approval prior to start of Tenant construction.
- Professional quality drawings/renderings must be submitted for approval.
- Design shall be an integral part of the graphics and complimentary to primary signage character.
- Overall width of menu board cannot exceed 60% of overall Storefront width.
- Mounting height to be a minimum of 7'-0" to bottom of sign with maximum height of 10'-0" and held a minimum of 10" from edge of walls.
- The menu board must be non-reflective to avoid glare.

PERMITTED ELEMENTS

Permitted menu board design elements include:

- Artisan type quality such as chalkboards, painted wood or unusual materials and combinations of material.
- Frames, holders, text, photo displays, lighting and materials must be creatively designed.
- High quality digital printouts for menu board may be approved at Landlord's discretion.
 - Photographs used in menu boards must be professionally produced and approved by the Landlord.
 - Plasma screens cannot be surface mounted.
- Externally illuminated menu boards are allowed.
 - Tenant is required to submit light fixture cut sheet for approval.

PROHIBITED ELEMENTS

Not permitted menu board design elements include:

- Standard factory designs.
- Standard surface-mounted box-type internally illuminated menu boards are not permitted.



> TECHNICAL

Food Court Tenants must adhere to the technical requirements found in the [INLINE TECHNICAL CRITERIA](#).

In addition to the requirements detailed in the Technical Criteria, Tenants cooking food in their space must adhere to the following:

GENERAL REQUIREMENTS

- Grease interceptors are required for all food preparation areas and must be vented as required by the jurisdictional authorities or health department.
- Interceptors shall be furnished and installed by the Tenant within the premises. Tenant shall be responsible for the proper care, cleaning, and maintenance thereof.
- The grease trap shall be designed and vented in accordance with the Plumbing Code. Tenant shall provide routine maintenance including cleaning and emptying of the grease trap and grease waste plumbing piping and any other regular maintenance on at least a quarterly basis.
- Garbage disposals are not permitted.
- Floor drains must be provided where required by code. All floor drains installed in toilet rooms must have acceptable means to maintain a water seal in the trap.

KITCHEN EXHAUST REQUIREMENTS

- Tenants furnish, install, and maintain their own individual kitchen exhaust and make-up air systems, constructed, and installed in accordance with all other applicable codes and regulations. Kitchen exhaust fans shall be located on the roof in locations designated and approved by the Landlord. All exhaust systems must be electric motor drive, connected and controlled from the Tenant's space. Tenant shall provide conduit from Tenant space to the roof for this purpose. The routing path of the conduit must be approved by the Landlord.
- Kitchen hoods shall bear evidence of UL and NSF listing. Kitchen hoods must incorporate UL listed fire damper for supply air penetrations in accordance with NFPA 96.
- Hoods must be capable of removing at least 90% of the grease contained in the exhaust air. Grease removal filters shall be provided with access panels. The Tenant shall be responsible for cleaning filtration equipment on a timely basis. The hood must be designed for proper capture taking into account the type of cooking, in a manner accepted by a nationally recognized standard.
- The Tenant shall furnish, install, and maintain in proper working order, a UL listed wet chemical fire-extinguishing system to protect all kitchen hoods above cooking areas and, if required, extending into ductwork. Fire extinguishing system must be approved by the Landlord and meet the requirements of NFPA 96 and local codes.
- Kitchen exhaust ductwork shall be installed in a fire rated shaft provided by the Tenant. Location of the shaft and roof penetrations must be approved by the Landlord at the time of the drawing review. Duct work shall be constructed of 16-gage minimum

thickness carbon steel. Continuously weld all longitudinal and transverse joints. Where applicable, ducts shall be enclosed as required by NFPA 96 and local codes. Ducts need not be insulated when they are the only duct within the fire rated shaft and there is 6" clear to the shaft. When ducts serving other types of equipment are located within the same shaft, steps may be required by code to assure the fire separation between the systems. Exhaust ducts located outside the Tenant space must be enclosed in a two-hour rated assembly up to the shaft.

- Horizontal ducts shall be sloped and reservoirs with cleanout doors shall be provided by Tenant in accordance with the International Mechanical Code (IMC) at 20' - 0" on centers, or as otherwise required by code. The bottom edge of the cleanout door shall be not less than 2 inches above the bottom of the duct. Every run shall have at least one cleanout door. Provide a cleanout door and grease drain at the base of each vertical section of the kitchen exhaust duct. Cleanout doors and frames shall be fabricated of the same gage metal as the duct. Provide 1/8inch thick high temperature gasket, approved for use on kitchen exhaust ducts, between frame and duct and between door and frame.
- Tenant hoods will operate with direct connected outside air supply from the Tenant make-up air system and the conditioned space, in conformance with all applicable codes. The direction of air flow shall always be from the common area into the Tenant space. For spaces permitting smoking, air must flow into the Tenant space across the entire area of any openings leading outside the demised premises.
- Make-up air ductwork shall be fabricated from galvanized sheet metal in accordance with the standards of the Sheet Metal and Air Conditioning Contractors National Association of America, latest edition and shall be insulated with 1-1/2" fiberglass or equal.
- Ductwork for dishwasher steam appliance and oven exhaust shall be fabricated rectangular low-pressure stainless steel or aluminum ductwork of at least 20 gage minimum thickness. Ductwork shall be properly pitched to drain to the hood connection and joints shall be fully sealed to prevent leaking.
- Tenant ductwork shall be shown on the plans, coordinated with base building construction, and any code required fire dampers shall be installed at the Tenant's expense.
- Air balance of any exhaust and makeup systems shall be the responsibility of the Tenant, and Tenant shall furnish Landlord with a copy of a certified air balance report.
- Tenant shall operate the exhaust and make-up system during all hours of cooking operation.



INLINE COUNTER SERVICE > CONTENTS

❑ DESIGN

- ❑ *PREP & FOOD DISPLAY / LAYOUT*
- ❑ *QUEUE / PATIOS / SEATING*
- ❑ *COUNTER DESIGN / COUNTER ELEMENTS*
- ❑ *MATERIALS / LIGHTING / FLOORING*

❑ SIGNAGE

- ❑ *PRIMARY SIGNAGE / MENU BOARDS*

❑ TECHNICAL

SECTIONS OF INTEREST

- ❑ *INLINE CRITERIA*
Includes standard design, technical, and sign requirements in addition to the contents in this section.
- ❑ *DESIGN INSPIRATION*
Provides design inspirations for visual aesthetics.
- ❑ *BUILDING DETAILS*
Includes property reference photos and specific storefront design details.
- ❑ *PROPERTY INFO*
Includes information on the Property's building codes, area permitting, and required contractors.
- ❑ *SUBMITTALS*
Outlines requirements on how and what to compile for submittals to the Landlord for design reviews.

The Inline Food Counter Service Criteria provides key technical information and design requirements to ensure your common area facing counter food service enlivens the consumer experience and interfaces with the Center.

This criteria will often point to the [INLINE RETAIL CRITERIA](#) as several requirements and design concepts are shared. The content in this section highlights the unique concepts for food service design.

The tenant and the tenant's architect assume the following important obligations:

- Fulfill the intent of the Criteria both in concept and in detail.
- Determine and respond to the actual physical conditions of the Tenant's location.
- Maintain and enhance the high standards of quality established in the construction of the Center.
- Ensure the quality of execution of all design material, finish, and detail concepts in the construction of the Tenant's improvement.
- Provide the required detail at all transitions from Tenant storefront to neighboring storefronts, as well as to the base building.



> DESIGN > PREP & FOOD DISPLAY / LAYOUT

Inline and Restaurant Food Tenants must adhere to the design requirements found in the [INLINE RETAIL DESIGN CRITERIA](#).

In addition to the requirements detailed in the Design Criteria, Tenants serving food in their space must adhere to the following design requirements:

PREPARATION AS THEATER

Tenant's offering a peek into the making of food, by nature, include the Customer and make for an authentic experience. This inclusion of the Customer will increase engagement and is highly encouraged.

FOOD DISPLAY

When displaying food, the following requirements must be followed:

- Showcases must reinforce the Tenant's image and be an integral part of the design within the counter.
- Glass must be tempered or a safety type. Plexiglas is not permitted.
- Showcases shall not exceed 14" above counter and 36" overall width. It shall not be more than 50% of the counter length and located no closer than 48" from the neutral pier.

LAYOUT

Due to the high visibility of the Customer Service Area particular attention is given to the design review of this area. Service areas, furnishings, display cookery, food prep and cooking areas visible from the mall common area must meet strict design standards.

- Support rooms and storage shall be concealed from public view.
- A full-height partition wall must separate the Customer Service Area and Prep Area.
- Access to the Prep Area shall be via a self-closing door or between staggered "blind walls".



> DESIGN > QUEUE / PATIOS / SEATING

QUEUE AREAS

- All food venues must provide a queue layout that allows for the Mall to maintain its code minimum distances for general circulation.
- Stanchions are not allowed. Other indicators for customer directional flow will be considered.

PATIO AREAS

Exposed patios are encouraged however, they should not extend beyond the lease line. In special cases there may be opportunity to extend the patio but it must be in compliance with all common mall code, circulation requirements, and leasing agreements.

Projection or canopy may increase the visibility of the storefront over seating areas. They also help with lighting the Storefront.

- Common mall flooring must be maintained. Coordinate with Landlord design if railings or other elements will have an effect on the flooring.

SEATING

Where interior seating is needed or desired, it is suggested that the enclosure line be moved into the lease space by approximately 12 feet.

- Patio seating must be separated from the common area circulation in the Mall. A layout will be required.
- All visible furniture must be reviewed by the Landlord for suitability both aesthetically, as well as for performance specifications.
- Tenant is responsible to confirm additional requirements with the local authorities for any railing or barrier for the Tenant's proposed area.
- In some cases options for furniture may be supplied by the mall design team for the Tenant to choose from.



> COUNTER DESIGN / COUNTER ELEMENTS

FRONT SERVICE COUNTER DESIGN

- The form and materials used for counters shall be designed to be inviting to the public to help lure them to the space.
- Tenant to specify a protective edge at the bottom of the counter.
- Counter tops must be “Corian” or similar solid surface materials, metal or stone. Tenant counter and counter tops are to be custom designed and fabricated.
- Plastic laminated countertops are prohibited.
- Maximum counter height is 3’-6”. Counter design, including heights, must comply with all accessibility guidelines enforced by national or local jurisdictions and the Americans with Disabilities Act.
- Sneeze guards shall be used above the front counters as required.

COUNTERTOP ELEMENTS

- Cash registers must be recessed so that they extend no more than 9” above the counter top.
- Condiment and utensil displays or dispensers must be fully recessed into the counter.
- Fully recessed counter-top trash receptacles (for straw wrappers, etc.) must be provided near the condiment and utensil displays.
- Drink dispenser and other utilitarian kitchen equipment may not be placed on the front counter.



> MATERIALS / LIGHTING / FLOORING

FRONT SERVICE COUNTER AND STOREFRONT MATERIALS

All finish materials must be backed by a minimum 5/8" solid surface material and may include the following:

- Countertops must be solid surface materials, metal or stone. Tenant counter and counter tops are to be custom designed and fabricated.
- All stone/tile colors must be integral throughout.
- Metal panels and architectural hardware shall have a professional and durable finish.
- Color anodized, baked painted or antique finish
- Wood veneers and weathered or distressed wood (submit specification for approval)
- Resin panels such as 3-Form products
- Back-painted tempered glass panels
- Glass tiles

Finish materials shall NOT include the following materials:

- 4"x4", 6"x6", 12"x12" tiles
- Shingles or boards
- Plastic laminate
- Faux or plastic formed brick, block or stone
- Clear anodized aluminum
- Other materials as deemed unacceptable by Landlord.

LIGHTING

- Tenants must light both their Storefront as well as the countertop. Lighting on architectural elements and menu boards are required.

FLOORING

- All "wet" areas must install a waterproof membrane that is tested and confirmed by the Landlord. Full requirements can be found in the plumbing section of the [INLINE TECHNICAL CRITERIA](#).



> SIGNAGE > PRIMARY / MENU BOARDS

PRIMARY STOREFRONT SIGN

Inline and Restaurant Food Tenants must adhere to the signage requirements found in the [INLINE SIGN CRITERIA](#).

MENU BOARDS

Inline and Restaurant Food Tenants must adhere to the menu board requirements found in the [FOOD COURT SIGN CRITERIA](#).

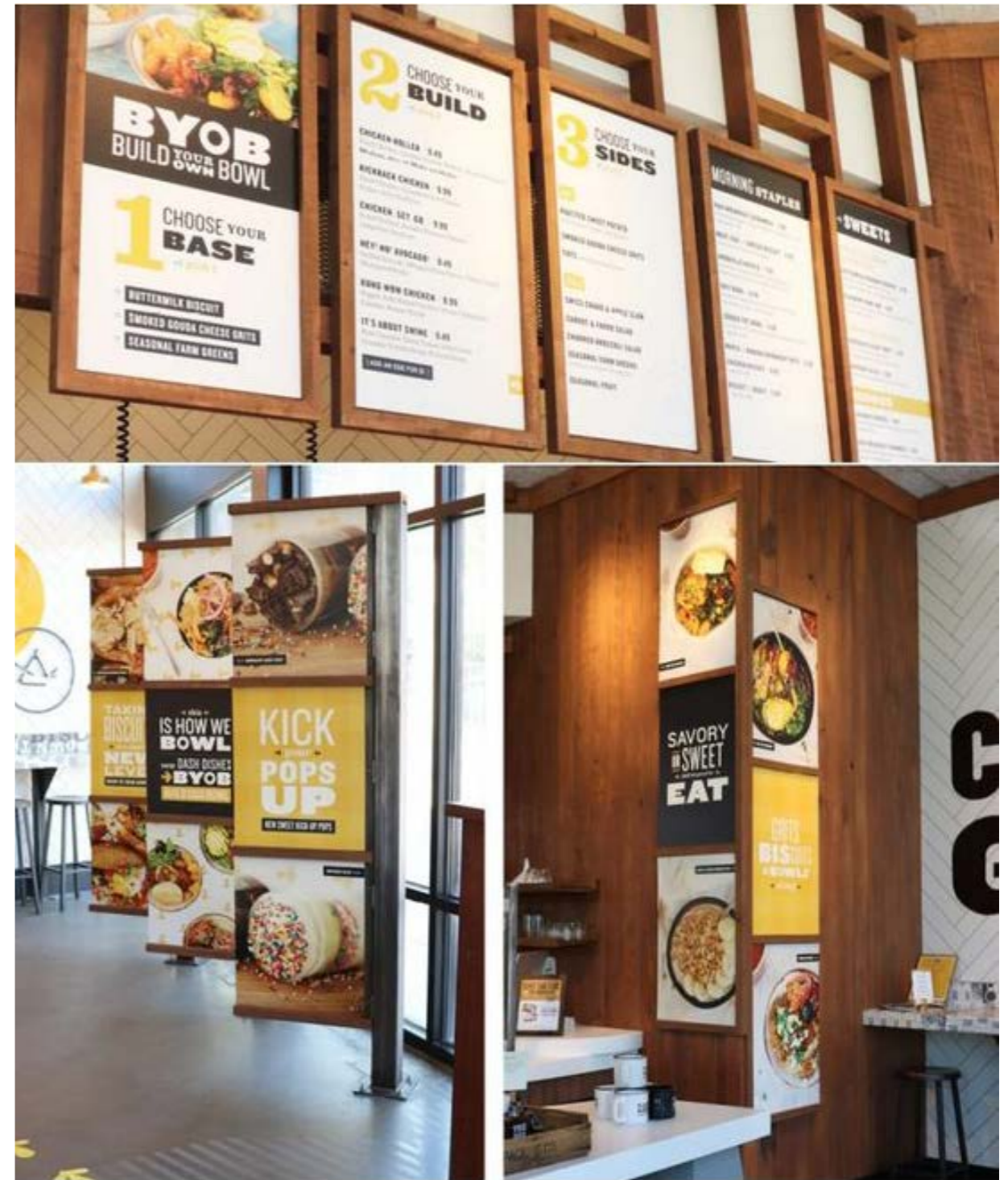

> TECHNICAL

Inline and Restaurant Food Tenants must adhere to the technical requirements found in the [INLINE TECHNICAL CRITERIA](#).

In addition to the requirements detailed in the Technical Criteria, Tenants cooking food in their space must adhere to the following:

GENERAL REQUIREMENTS

- Grease interceptors are required for all food preparation areas and must be vented as required by the jurisdictional authorities or health department.
- Interceptors shall be furnished and installed by the Tenant within the premises. Tenant shall be responsible for the proper care, cleaning, and maintenance thereof.
- The grease trap shall be designed and vented in accordance with the Plumbing Code. Tenant shall provide routine maintenance including cleaning and emptying of the grease trap and grease waste plumbing piping and any other regular maintenance on at least a quarterly basis.
- Garbage disposals are not permitted.
- Floor drains must be provided where required by code. All floor drains installed in toilet rooms must have acceptable means to maintain a water seal in the trap.

KITCHEN EXHAUST REQUIREMENTS

- Tenants furnish, install, and maintain their own individual kitchen exhaust and make-up air systems, constructed, and installed in accordance with all other applicable codes and regulations. Kitchen exhaust fans shall be located on the roof in locations designated and approved by the Landlord. All exhaust systems must be electric motor drive, connected and controlled from the Tenant's space. Tenant shall provide conduit from Tenant space to the roof for this purpose. The routing path of the conduit must be approved by the Landlord.
- Kitchen hoods shall bear evidence of UL and NSF listing. Kitchen hoods must incorporate UL listed fire damper for supply air penetrations in accordance with NFPA 96.
- Hoods must be capable of removing at least 90% of the grease contained in the exhaust air. Grease removal filters shall be provided with access panels. The Tenant shall be responsible for cleaning filtration equipment on a timely basis. The hood must be designed for proper capture taking into account the type of cooking, in a manner accepted by a nationally recognized standard.
- The Tenant shall furnish, install, and maintain in proper working order, a UL listed wet chemical fire-extinguishing system to protect all kitchen hoods above cooking areas and, if required, extending into ductwork. Fire extinguishing system must be approved by the Landlord and meet the requirements of NFPA 96 and local codes.
- Kitchen exhaust ductwork shall be installed in a fire rated shaft provided by the Tenant. Location of the shaft and roof penetrations must be approved by the Landlord at the time of the drawing review. Duct work shall be constructed of 16-gage minimum

thickness carbon steel. Continuously weld all longitudinal and transverse joints. Where applicable, ducts shall be enclosed as required by NFPA 96 and local codes. Ducts need not be insulated when they are the only duct within the fire rated shaft and there is 6" clear to the shaft. When ducts serving other types of equipment are located within the same shaft, steps may be required by code to assure the fire separation between the systems. Exhaust ducts located outside the Tenant space must be enclosed in a two-hour rated assembly up to the shaft.

- Horizontal ducts shall be sloped and reservoirs with cleanout doors shall be provided by Tenant in accordance with the International Mechanical Code (IMC) at 20' - 0" on centers, or as otherwise required by code. The bottom edge of the cleanout door shall be not less than 2 inches above the bottom of the duct. Every run shall have at least one cleanout door. Provide a cleanout door and grease drain at the base of each vertical section of the kitchen exhaust duct. Cleanout doors and frames shall be fabricated of the same gage metal as the duct. Provide 1/8inch thick high temperature gasket, approved for use on kitchen exhaust ducts, between frame and duct and between door and frame.
- Tenant hoods will operate with direct connected outside air supply from the Tenant make-up air system and the conditioned space, in conformance with all applicable codes. The direction of air flow shall always be from the common area into the Tenant space. For spaces permitting smoking, air must flow into the Tenant space across the entire area of any openings leading outside the demised premises.
- Make-up air ductwork shall be fabricated from galvanized sheet metal in accordance with the standards of the Sheet Metal and Air Conditioning Contractors National Association of America, latest edition and shall be insulated with 1-1/2" fiberglass or equal.
- Ductwork for dishwasher steam appliance and oven exhaust shall be fabricated rectangular low-pressure stainless steel or aluminum ductwork of at least 20 gage minimum thickness. Ductwork shall be properly pitched to drain to the hood connection and joints shall be fully sealed to prevent leaking.
- Tenant ductwork shall be shown on the plans, coordinated with base building construction, and any code required fire dampers shall be installed at the Tenant's expense.
- Air balance of any exhaust and makeup systems shall be the responsibility of the Tenant, and Tenant shall furnish Landlord with a copy of a certified air balance report.
- Tenant shall operate the exhaust and make-up system during all hours of cooking operation.



RESTAURANTS > CONTENTS

- DESIGN**
 - STOREFRONT / PREPARATION AS THEATER*
 - CONTROL AREAS / SEATING*
 - EXTERIOR*

- SIGNAGE**
 - STOREFRONT / MENU BOARDS*

- TECHNICAL**

SECTIONS OF INTEREST

- INLINE CRITERIA**

Includes standard design, technical, and sign requirements in addition to the contents in this section.
- DESIGN INSPIRATION**

Provides design inspirations for visual aesthetics.
- BUILDING DETAILS**

Includes Property reference photos and specific Storefront design details.
- PROPERTY INFO**

Includes information on the Property's building codes, area permitting, and required contractors.
- SUBMITTALS**

Outlines requirements on how and what to compile for submittals to the Landlord for design reviews.

The Restaurant Criteria provides key technical information and design requirements to ensure your interior or exterior facing restaurant food service enlivens the consumer experience and interfaces with the Center.

This Criteria will often point to the [INLINE RETAIL CRITERIA](#) as several requirements and design concepts are shared. The content in this section highlights the unique concepts for food service design.

The Tenant and the Tenant's architect assume the following important obligations:

- Fulfill the intent of the Criteria both in concept and in detail.
- Determine and respond to the actual physical conditions of the Tenant's location.
- Maintain and enhance the high standards of quality established in the construction of the Center.
- Ensure the quality of execution of all design material, finish, and detail concepts in the construction of the Tenant's improvement.
- Provide the required detail at all transitions from Tenant Storefront to neighboring Storefronts, as well as to the base building.



> DESIGN > STOREFRONT / PREPARATION AS THEATER

Restaurant Food Tenants must adhere to the design requirements found in the [INLINE DESIGN CRITERIA](#).

In addition, Tenants serving food in their space must also adhere to the following:

GENERAL STOREFRONT AND DESIGN

We encourage a cohesive presentation of the brand within the context of the whole Mall design, while the individual brand is important and the two must harmonize. Design should be tailored to its location both within the community and the whole Center's aesthetics.

Restaurants may face both the interior and the exterior, and are often located adjacent to a Mall entry. The exterior and the interior are subject to different Criteria standards, both for presentation and signage.

Interior restaurants oftentimes have a waiting area within the common space.

- If needed these must be shown in the submissions and be approved by Landlord. They must be coordinated with common area needs and code requirements.

PREPARATION AS THEATER

Tenant's offering a peek into the making of food, by nature, include the Customer and make for an authentic experience. This inclusion of the Customer will increase engagement and is highly encouraged.



> CONTROL AREAS / SEATING

CONTROL AREAS

The DCA is the area at the front of the Tenant space that extends from the lease line to all points 6'-0" into the space. It should convey excitement and give the consumer a reason to engage.

Exposed patios are encouraged however, they should not extend beyond the lease line. In special cases there may be opportunity to extend the patio but it must be in compliance with all common Mall code and circulation requirements.

Projection or canopies may increase the visibility of the Storefront over seating areas. They also help with lighting the Storefront.

In addition to the general DCA Criteria for inline stores the following requirements must be met:

- All patio rails, reception podiums, waiting areas, menu presentations, lighting, heating, visible banquet detailing, and material palettes must be presented for review and approval.
- Common Mall flooring must be maintained. Coordinate with Landlord design if railings or other elements will have an effect on the flooring.

SEATING

Where interior seating is needed or desired, it is suggested that the enclosure line be moved into the lease space by approximately twelve (12') feet.

Seating design requirements include:

- Patio seating must be separated from the common area circulation in the Mall by a low barrier. A layout will be required for review.
- All visible furniture must be reviewed by the Landlord for suitability both aesthetically, as well as for performance specifications.
- Tenant is responsible to confirm additional requirements with the local authorities for any railing or barrier for the Tenant's proposed area.



> EXTERIOR

Restaurants with exterior Storefronts will be subject to the general Criteria in this manual, for aesthetics.

Exterior design should be tailored to its location both within the community as well as the whole Mall and its aesthetics.

SITE PLANS

- A Site Plan must be submitted that includes all required calculations for GLA, GBA, and parking requirements.
- Site Circulation must be included showing the adjacent intersections, driveways, drive directions, and dimensions of all access points.
- Photos of adjacent and onsite conditions may be required by Ownership for the review process.

AMENITIES

- Planters, heat lamps, tables, chairs etc., must be submitted for approval. All amenities must be commercial grade and suitable for outdoor use.
- Pendant or sconce lighting must be submitted for approval by Landlord.
 - Lighting plans of canopies and trellis are available in Landlord supplied base drawings.
- Umbrellas are only allowed in the designated areas and cannot overhang into the public right-of-way.
 - Umbrellas should be small in scale (maximum 6'-0" in diameter) and no more than 9'-0" high at the peak.
 - Wood or metal are the only acceptable materials for the umbrella structure. No insignia, graphics or text are permitted on the umbrella fabric.
 - The umbrella fabric must be flame retardant material in a color approved by Landlord's Tenant Coordinator.

EXTERIOR PATIOS

- Any changes to an existing patio must be approved by Landlord. Tenant is responsible to confirm the requirements with the local municipality for proposed use.
- Temporary elements such as greeting stands, or waiting areas must be submitted for review.
- Confirm code height and density of railings for any necessary barriers.
- Patio layouts with adjacent circulation dimensions must be included in the first submittal of documents for design review.
- Railing design details should be submitted with the concept and construction packages for approval by the Landlord design team.

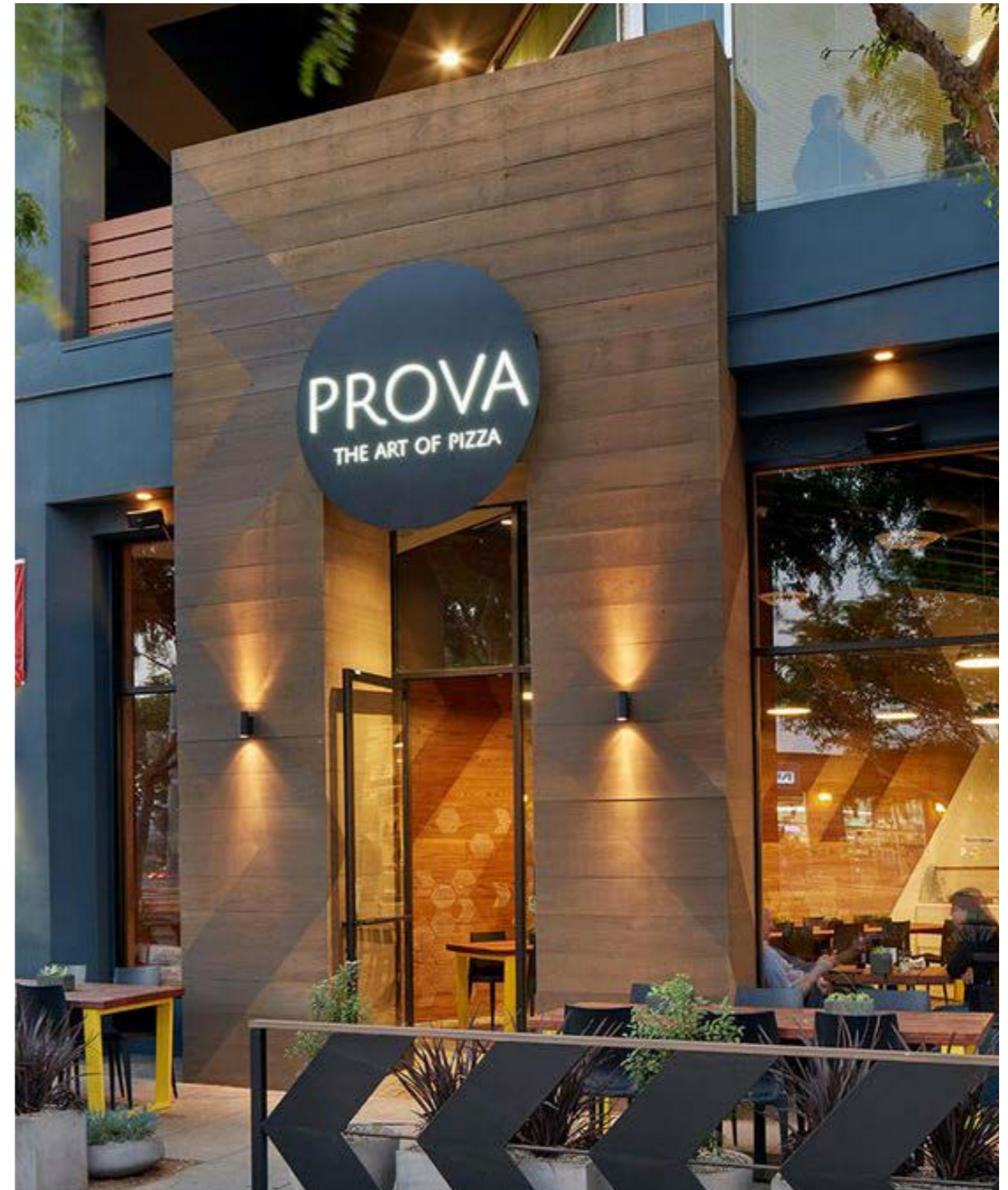

> SIGNAGE > PRIMARY / MENU BOARDS

PRIMARY STOREFRONT SIGN

Inline and Restaurant Food Tenants must adhere to the Signage requirements found in the [INLINE SIGN CRITERIA](#).

Exterior signage must adhere to the requirements established by the local municipality.

MENU BOARDS

Inline and Restaurant Food Tenants must adhere to the menu board requirements found in the [FOOD COURT SIGN CRITERIA](#).





> TECHNICAL

Inline and Restaurant Food Tenants must adhere to the technical requirements found in the [INLINE TECHNICAL CRITERIA](#).

In addition to the requirements detailed in the Technical Criteria, Tenants cooking food in their space must adhere to the same requirements found in the [INLINE FOOD TECHNICAL CRITERIA](#).



BUILDING DETAILS CONTENT OVERVIEW

- ZONE PLAN**

- COMMON AREA DETAILS**
 - P2 NORTHWEST ENTRY
 - P3 SAK'S COURT ENTRY
 - P4 TRANSITION
 - P5 TRANSITION
 - P6 KNUCKLE TRANSITION
 - P7 TYPICAL MALL

- ELEVATIONS**
 - TYPICAL ELEVATION
 - TYPICAL SECTION

- EXISTING CONDITION**
 - REFLECTIVE CEILING ONE
 - REFLECTIVE CEILING TWO
 - REFLECTIVE CEILING THREE

- DEMISING PIERS**
 - CONDITIONS MAP
 - DETAIL ONE
 - DETAIL TWO
 - DETAIL THREE
 - DETAIL FOUR
 - DETAIL FIVE

SECTIONS OF INTEREST

- PROPERTY INFO**

Includes information on the Property's building codes, area permitting, and required contractors.
- SUBMITTALS**

Outlines requirements on how and what to compile for submittals to the Landlord for design reviews.

The Building Details section provides existing building details and design requirements for Storefronts based on the space location.

It is the Tenant's responsibility to verify existing conditions and comply with all applicable codes and standards.

Tenants are required to adhere to the full Criteria during their design and construction.



MALL ZONES > OVERVIEW MAP

Click or tap on a Red Arrow reference location to navigate directly to the specific common area detail.

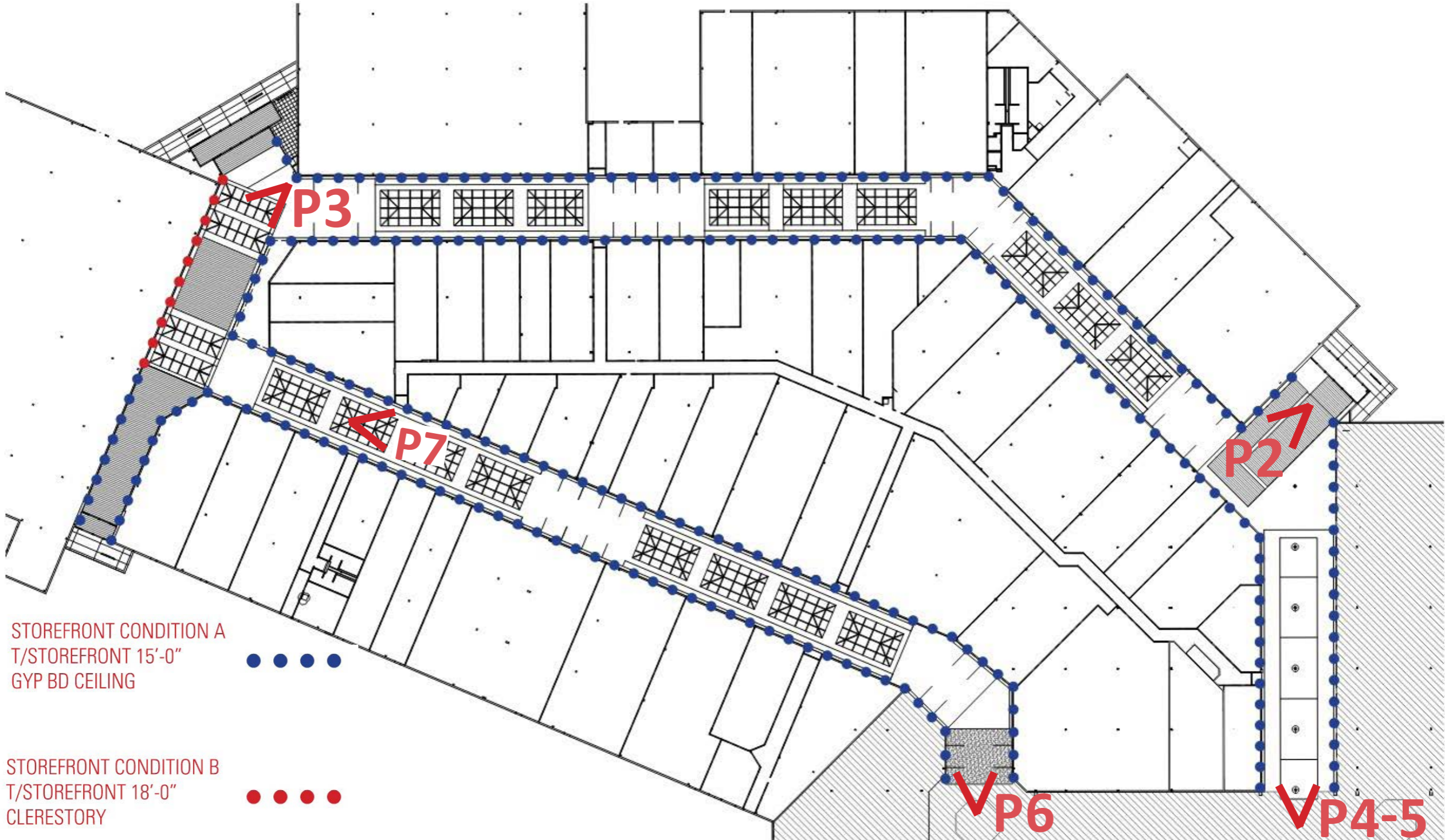

MALL COMMON AREA DETAIL > NORTHWEST ENTRY (P2)



MALL COMMON AREA DETAIL > SAK'S COURT ENTRY (P3)

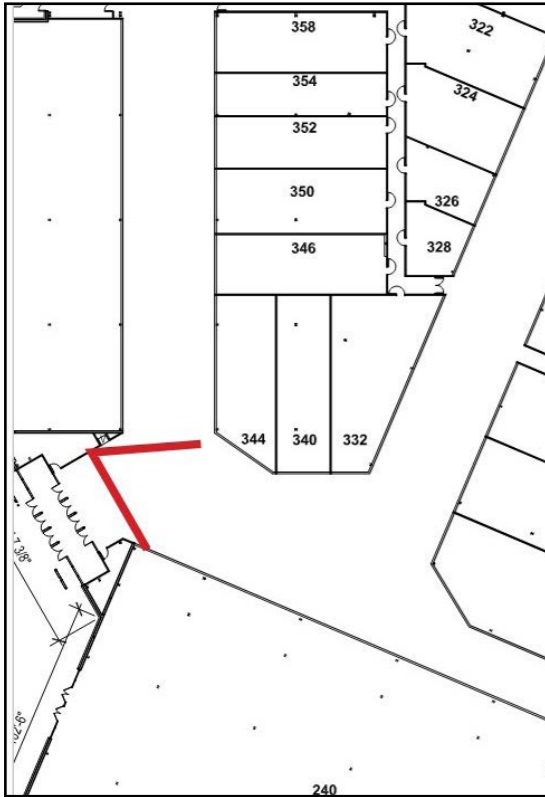

MALL COMMON AREA DETAIL > TRANSITION (P4)

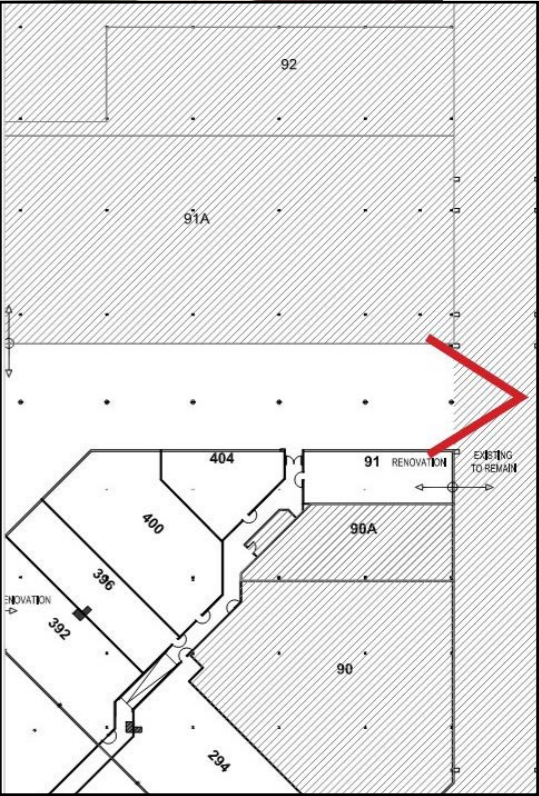

MALL COMMON AREA DETAIL > TRANSITION (P5)

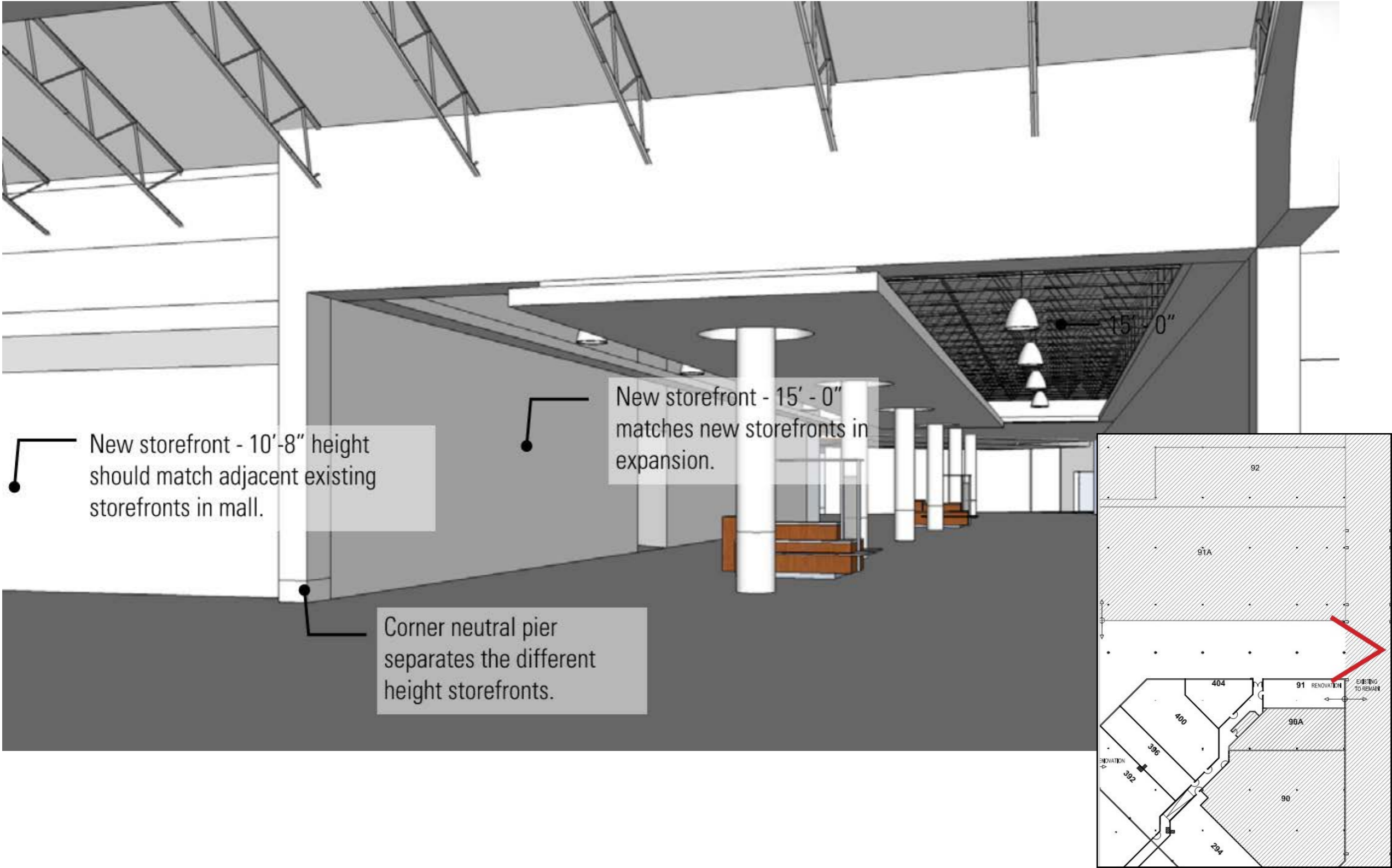

MALL COMMON AREA DETAIL > KNUCKLE TRANSITION (P6)

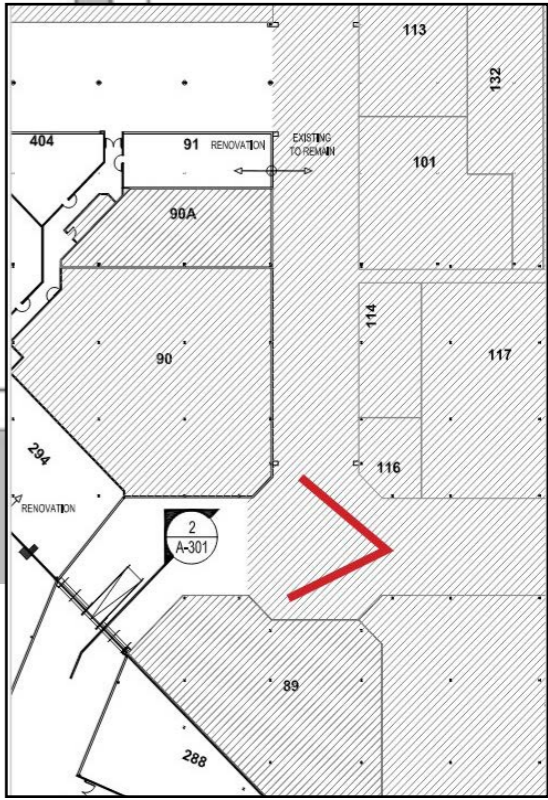
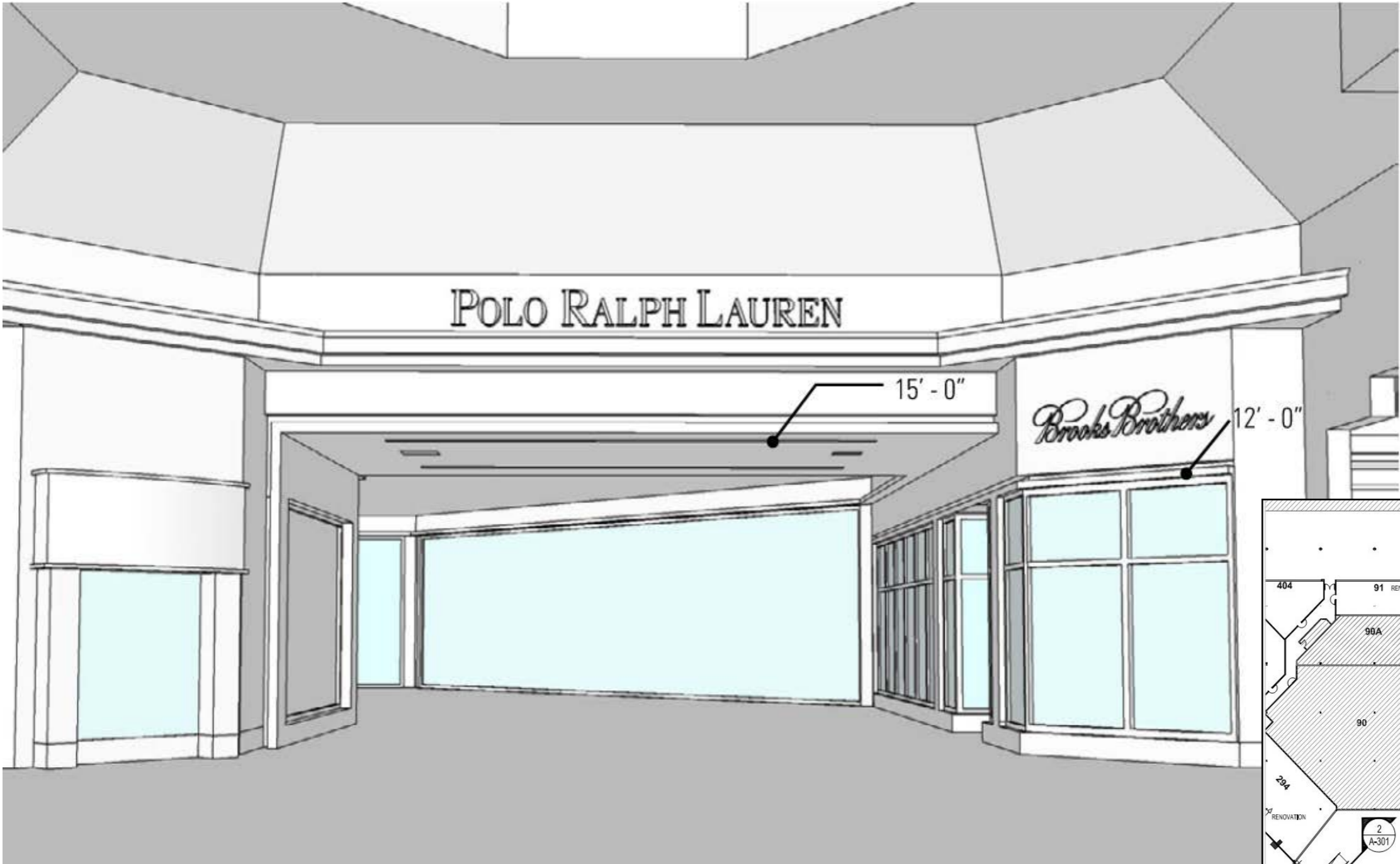

MALL COMMON AREA DETAIL > TYPICAL MALL (P7)

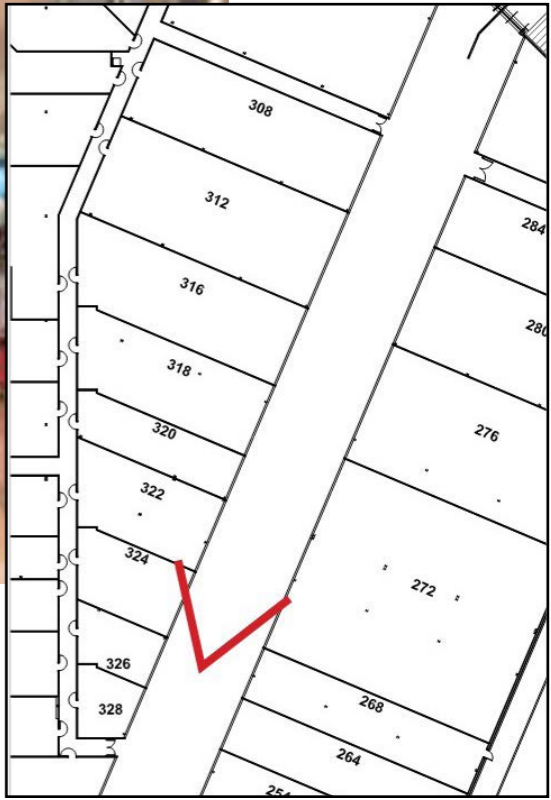

ELEVATIONS > TYPICAL ELEVATION

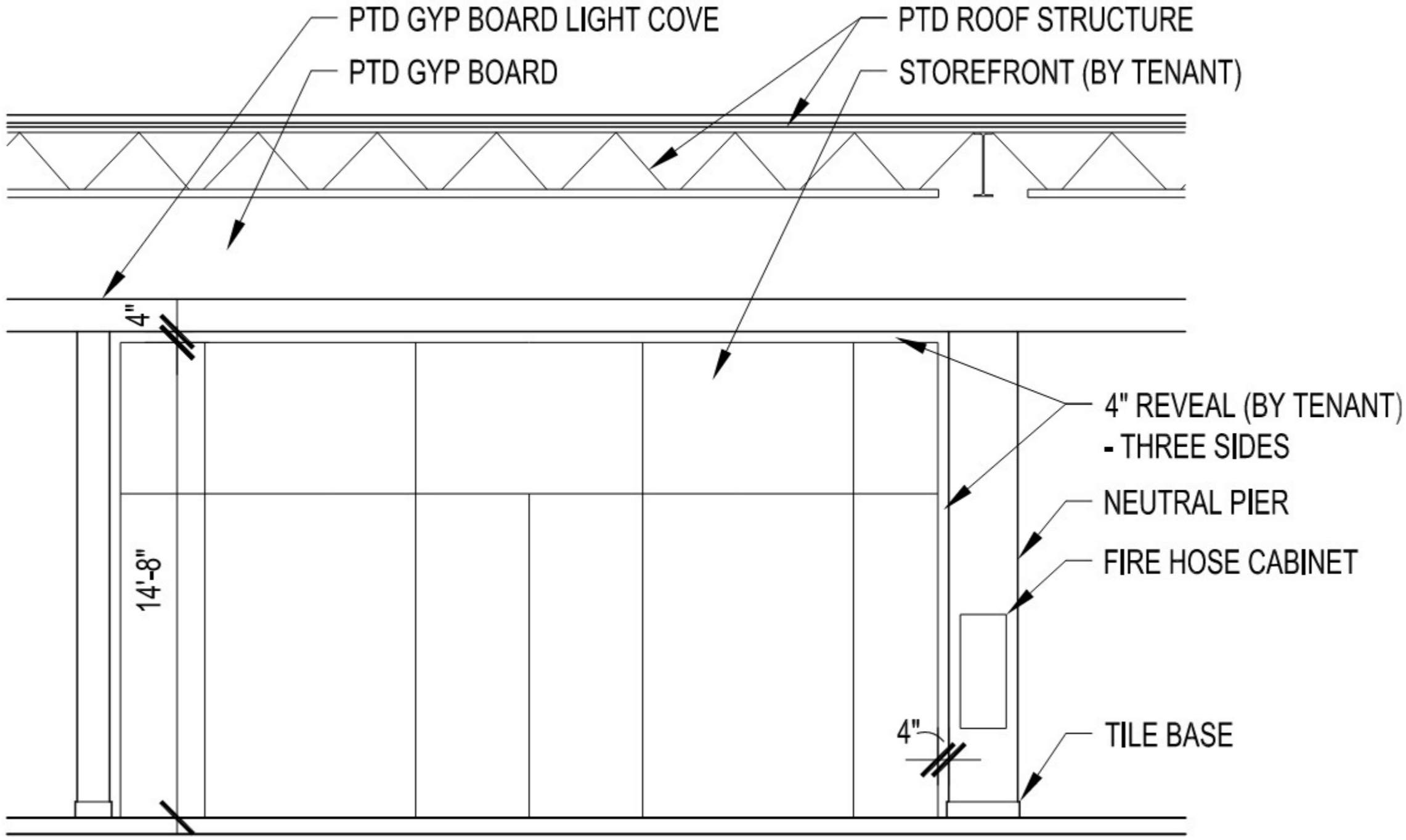

ELEVATIONS > TYPICAL SECTION

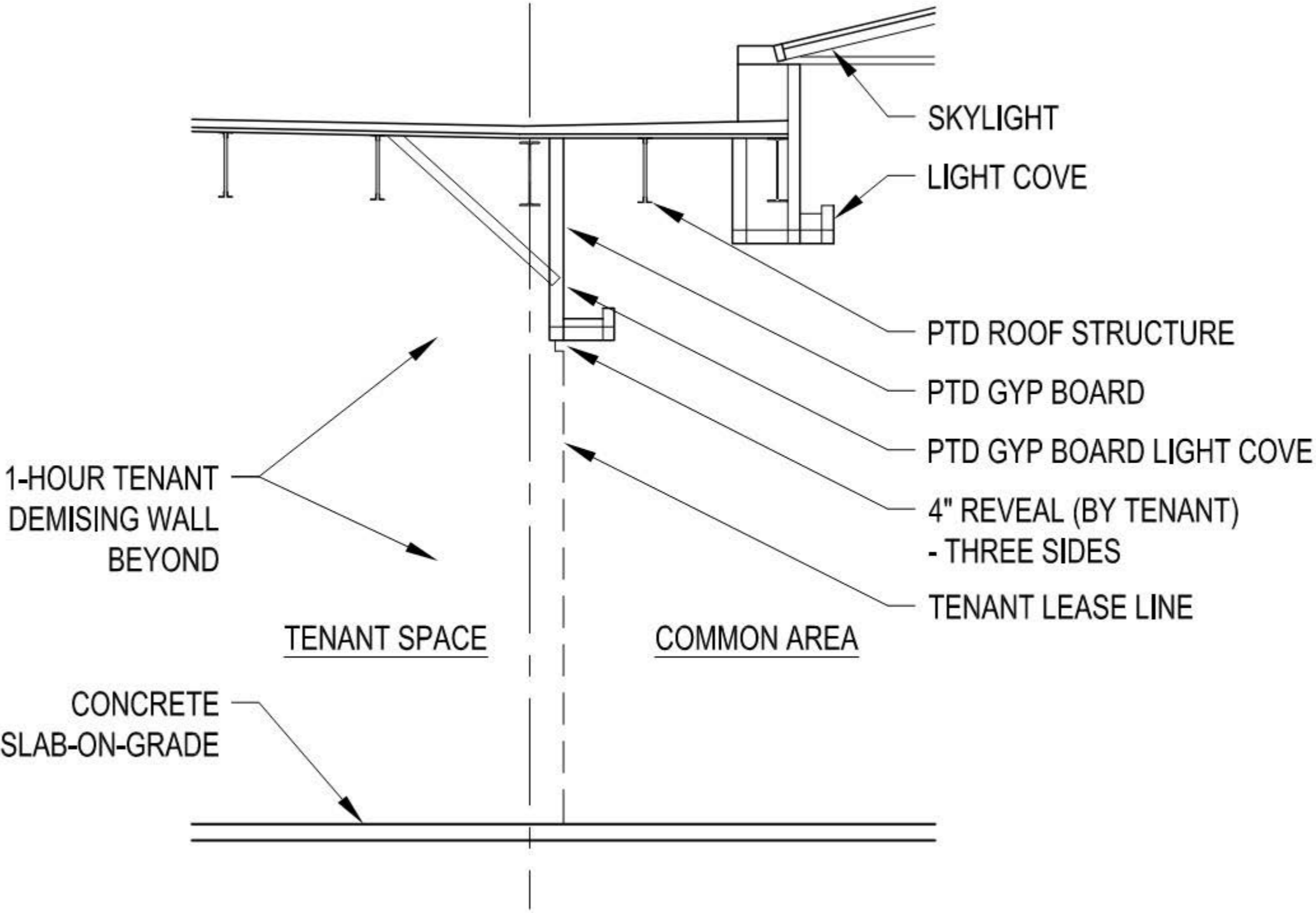

EXISTING CONDITION > REFLECTED CEILING PLAN (1)

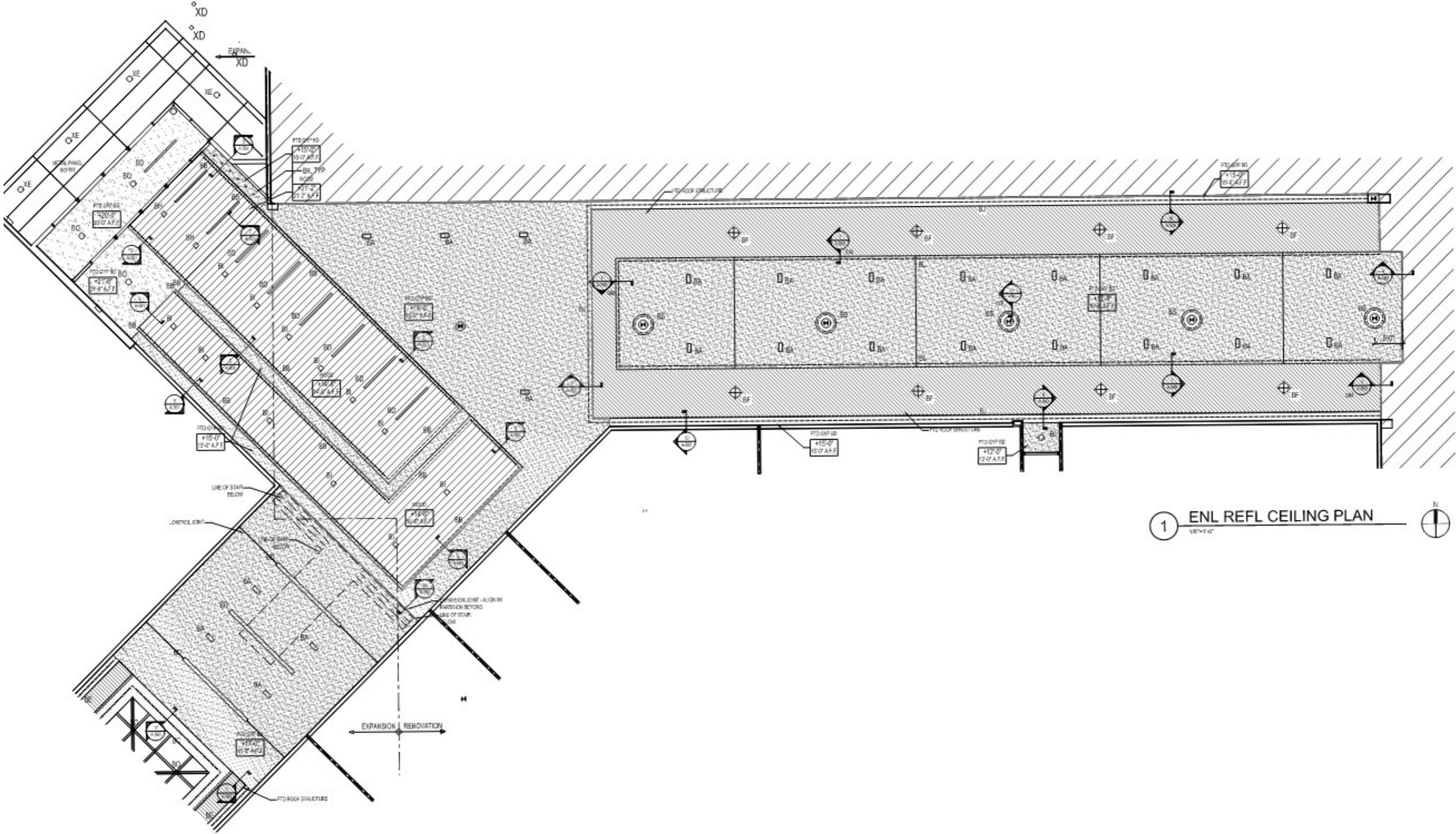

1 ENL REFL CEILING PLAN
1/8"=1'-0"



EXISTING CONDITION > REFLECTED CEILING PLAN (2)

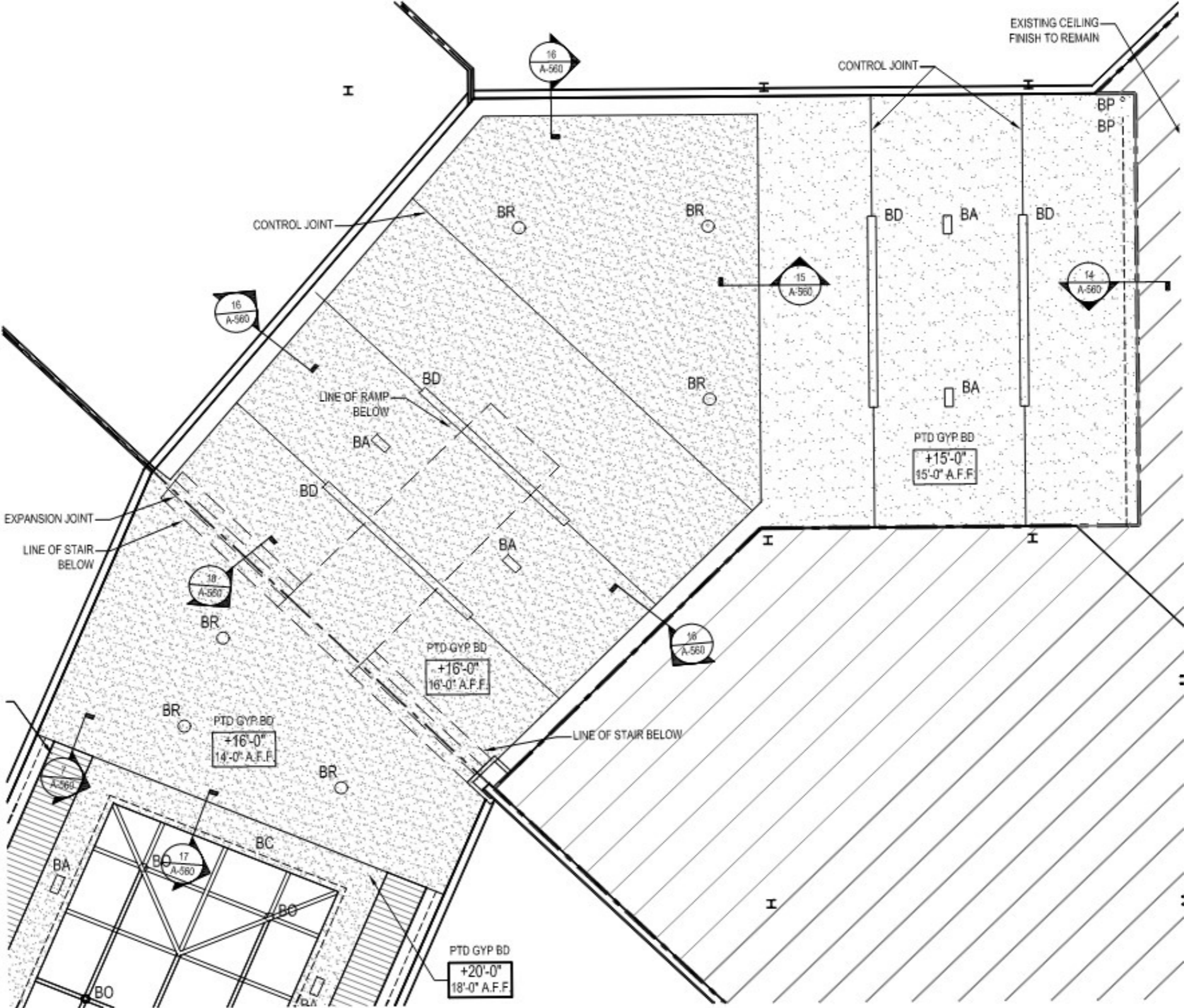



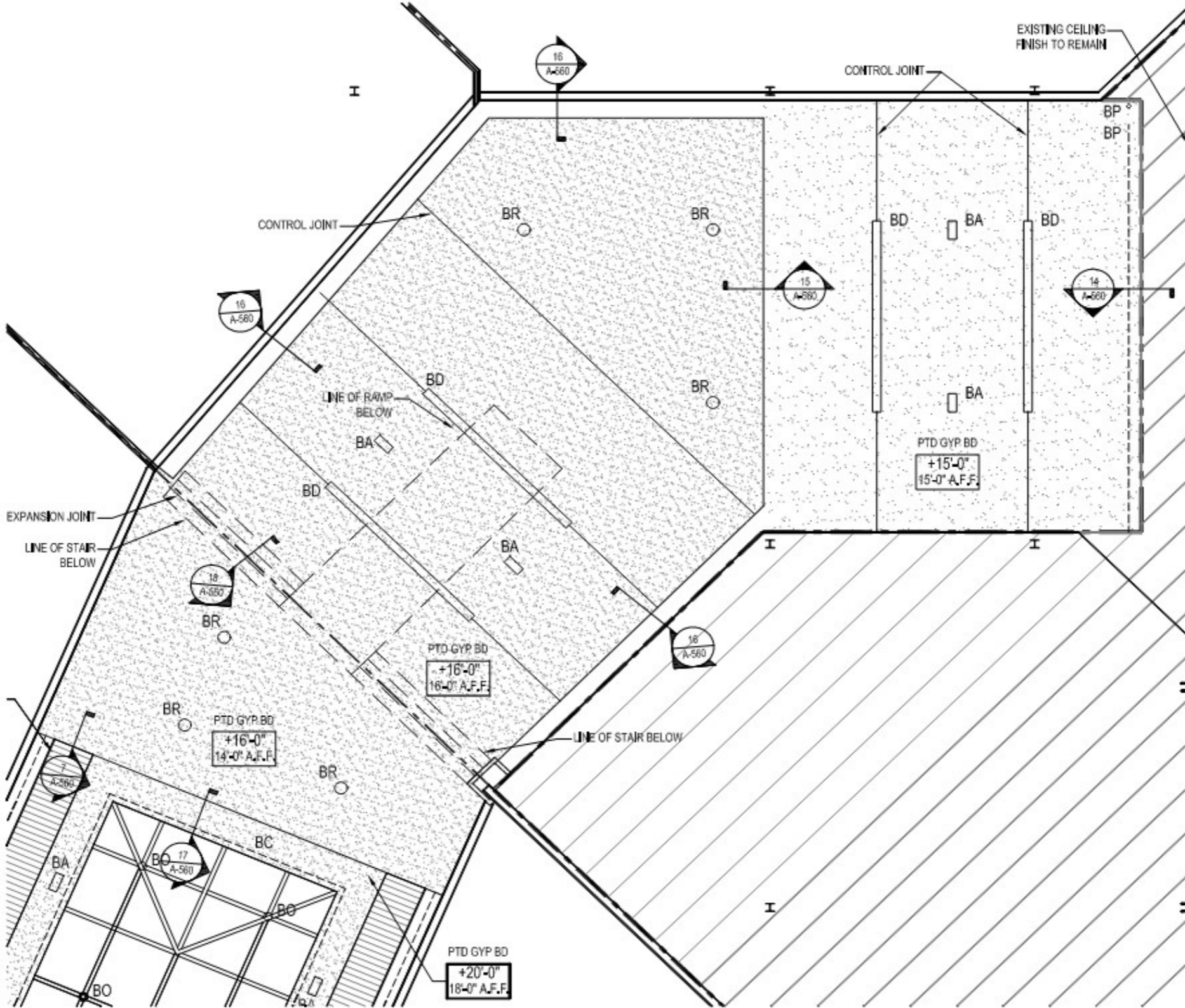



EXISTING CONDITION > REFLECTED CEILING PLAN (3)

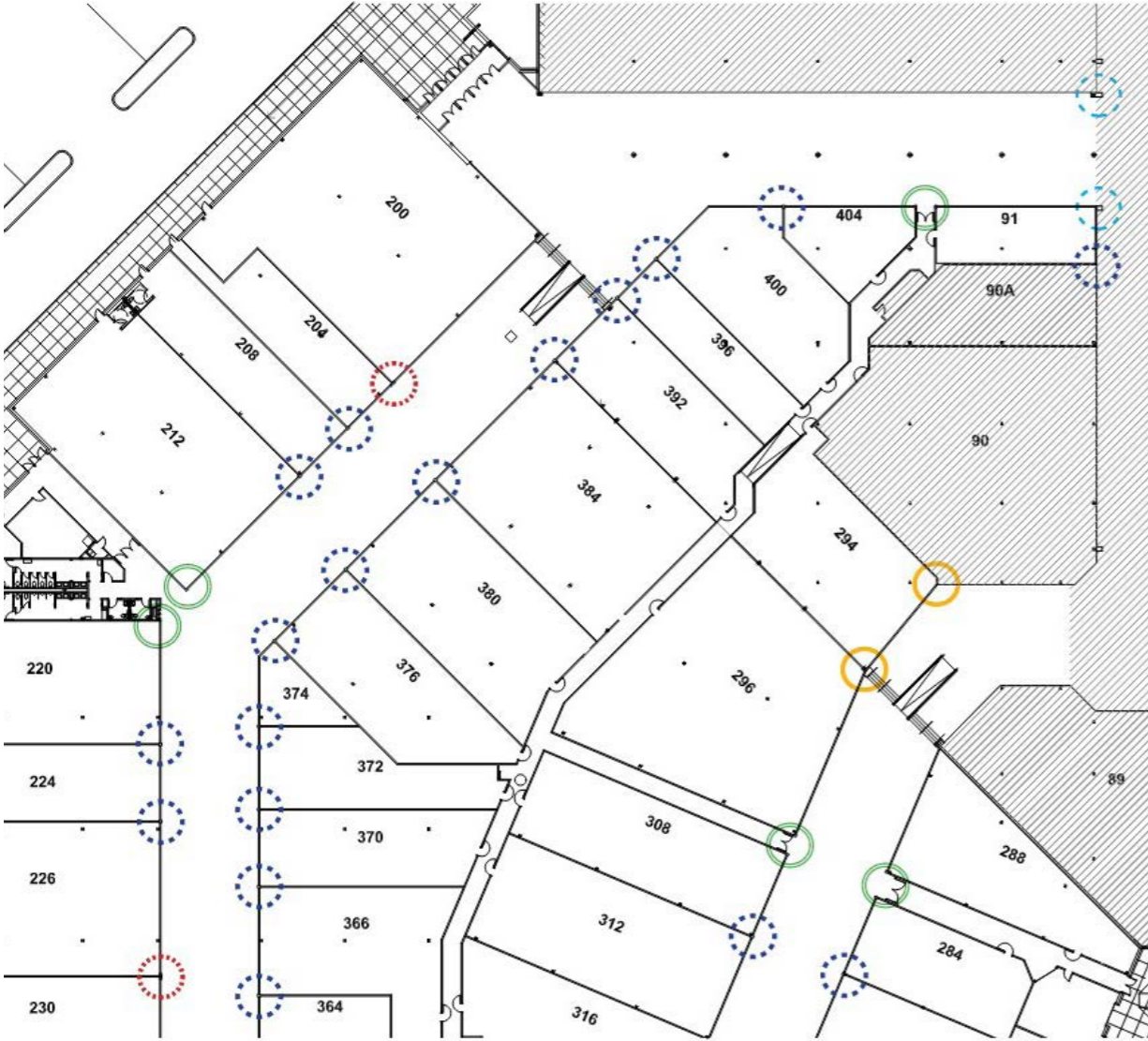

DEMISING PIER > DEMISING PIER CONDITIONS

Click or tap on a Neutral Pier in the Key to navigate directly to the specific detail.



-  STD. NEUTRAL PIER (PLAN DETAIL 1)
-  NEUTRAL PIER W/ FIRE VALVE CABINET (PLAN DETAIL 2)
-  NEUTRAL PIER AT ANGLE (PLAN DETAIL 3)
-  NEUTRAL PIER AT CORRIDOR (PLAN DETAIL 4)
-  NEUTRAL PIER AT EXISTING MALL (PLAN DETAIL 5)



DEMISING PIER > DEMISING PIER PLAN DETAIL ONE

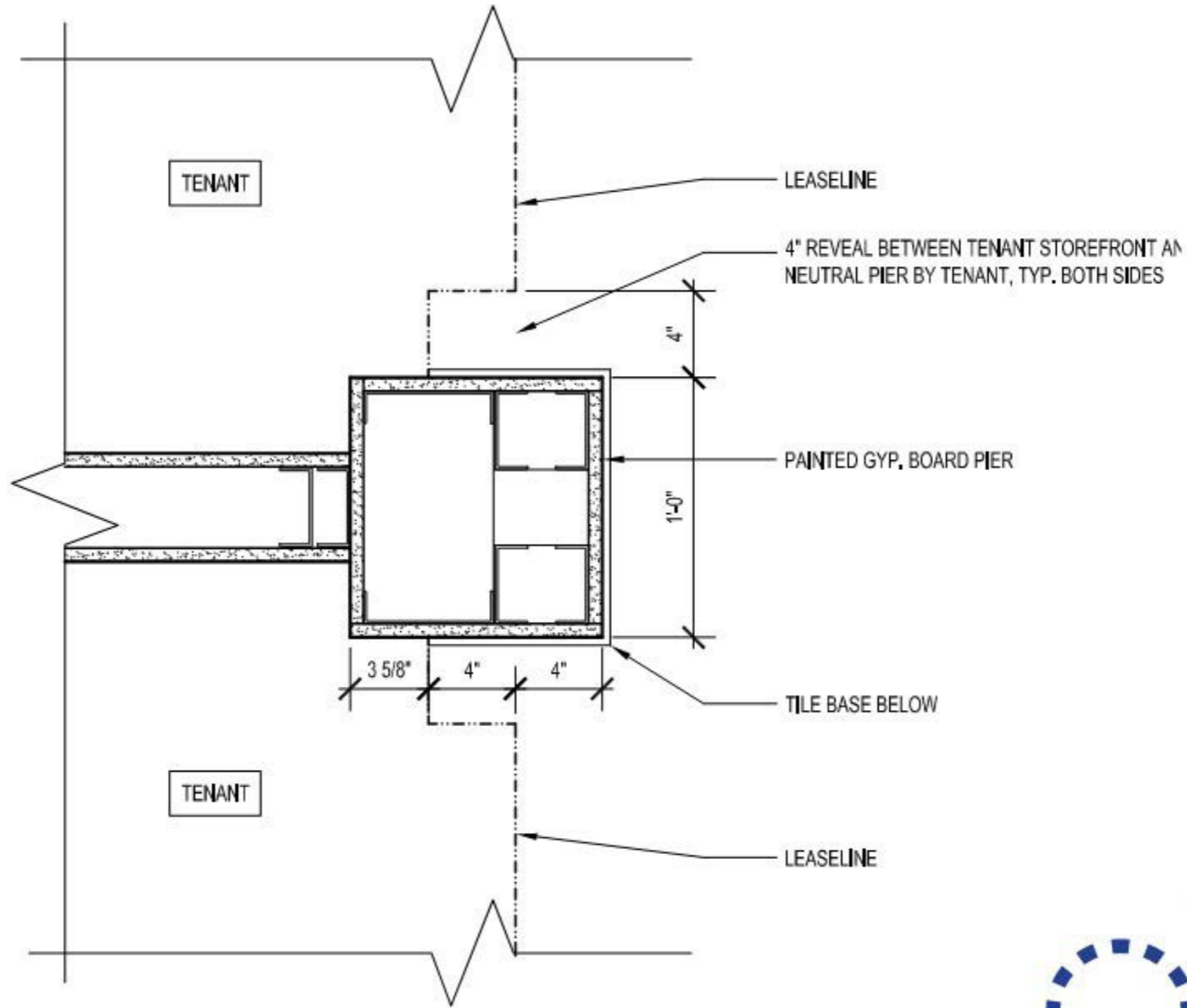

1

PLAN DETAIL NEUTRAL PIER

1 1/2" = 1'-0"

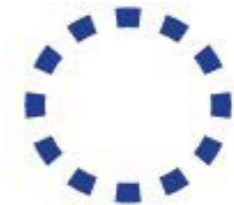

DEMISING PIER > DEMISING PIER PLAN DETAIL TWO

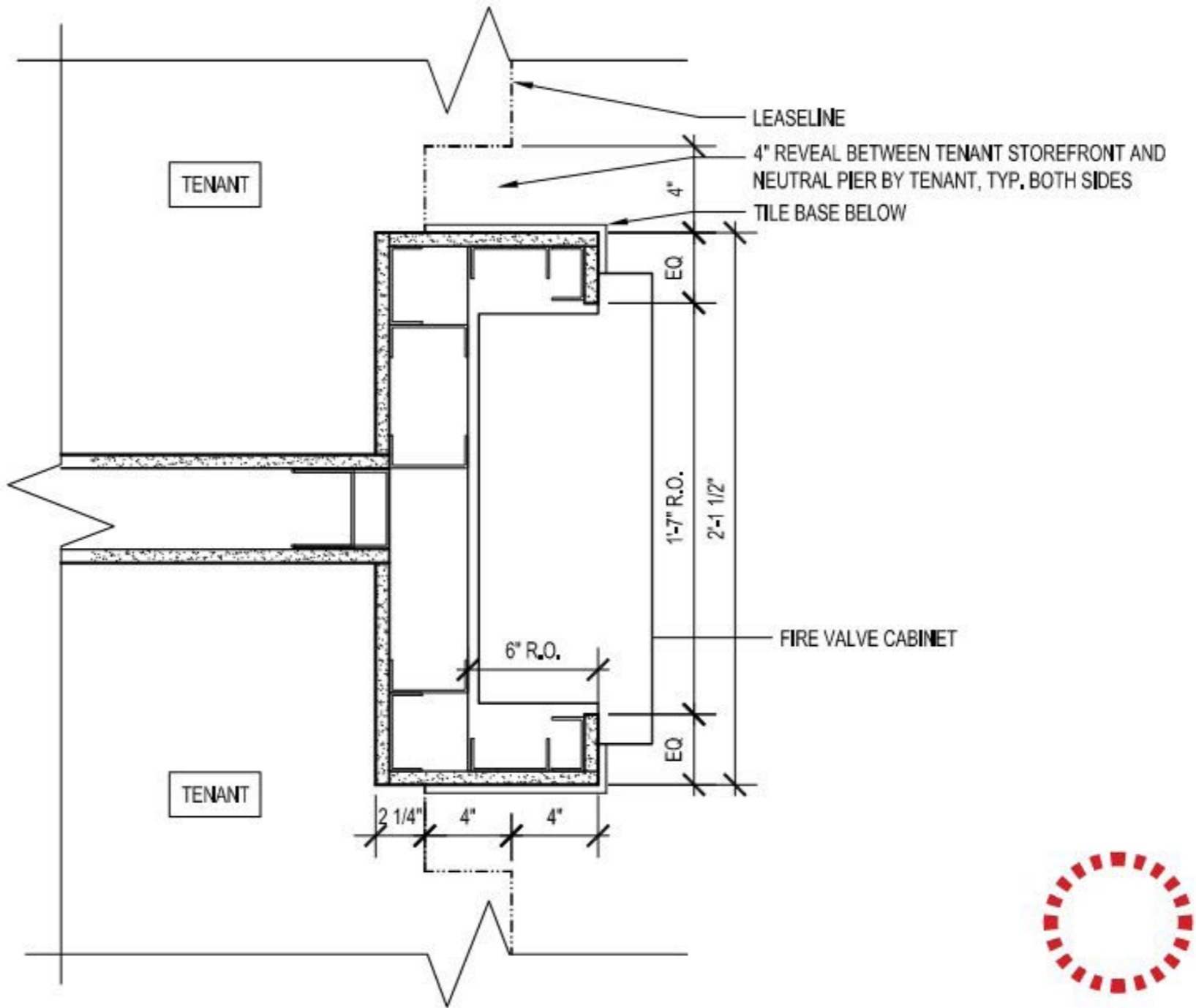

2

PLAN DETAIL FVC NEUTRAL PIER

1 1/2"=1'-0"



DEMISING PIER > DEMISING PIER PLAN DETAIL FOUR

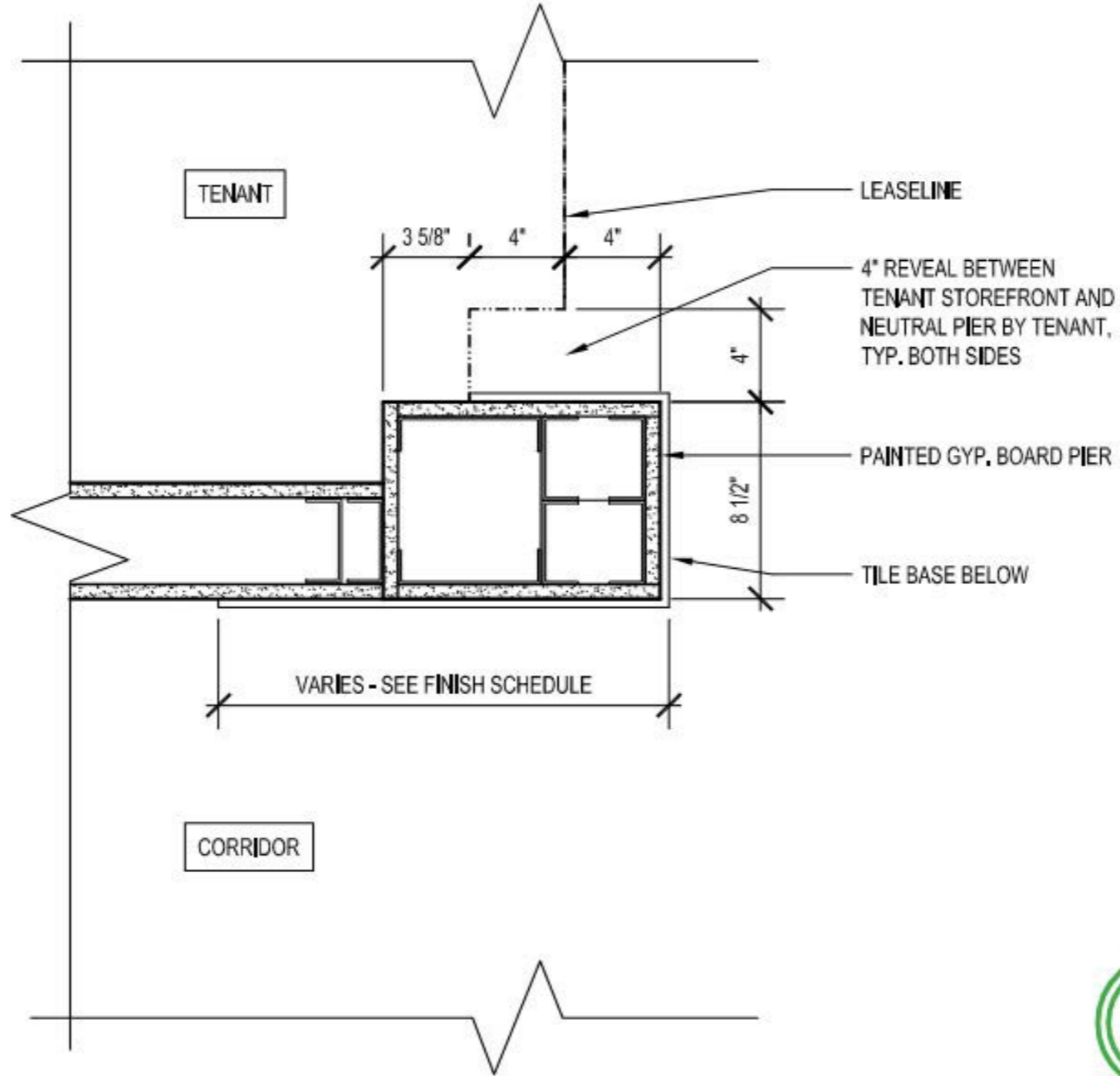

4

PLAN DETAIL NEUTRAL PIER

1 1/2" = 1'-0"



DEMISING PIER > DEMISING PIER PLAN DETAIL FIVE

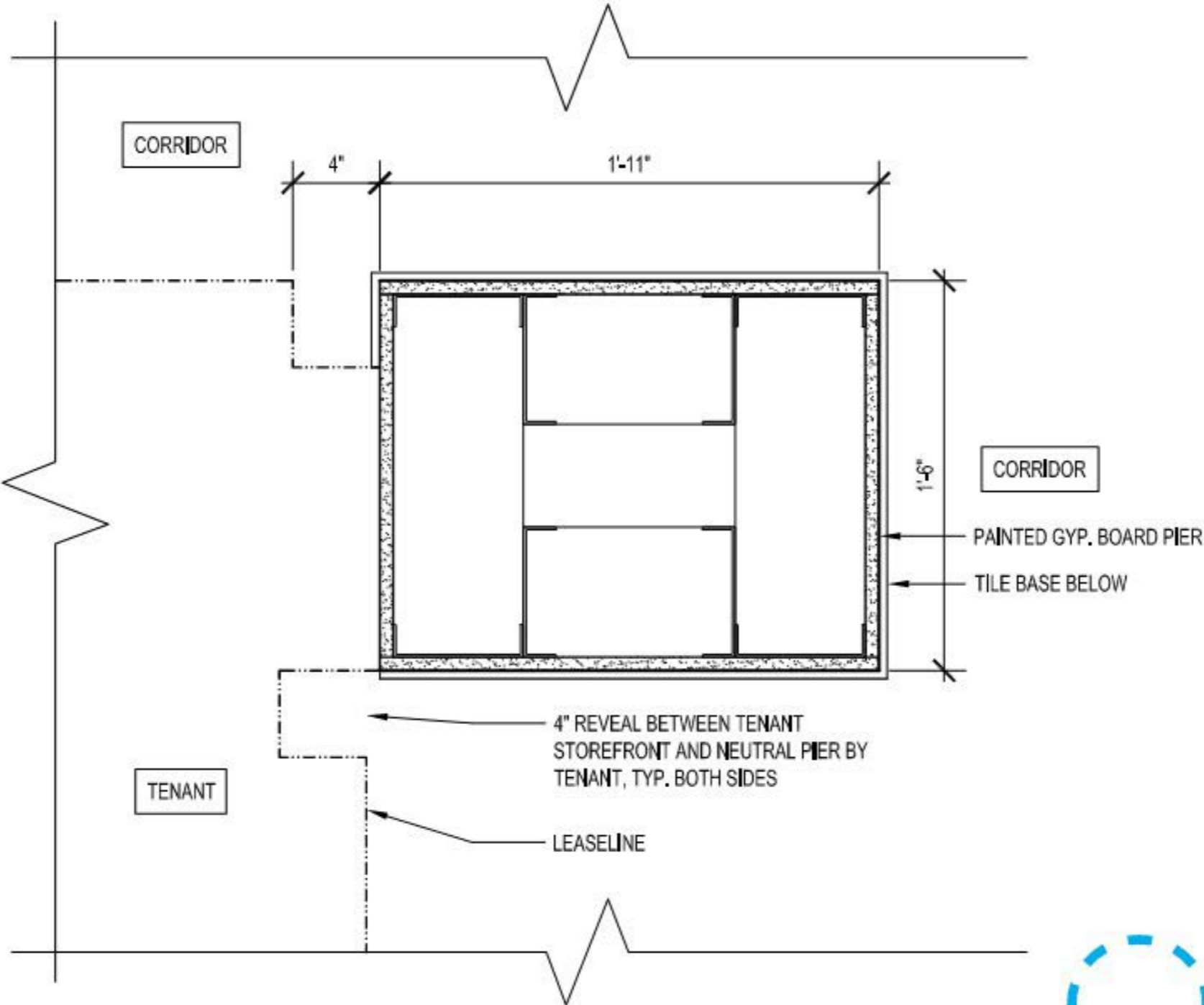

5

PLAN DETAIL PIER

1 1/2"=1'-0"

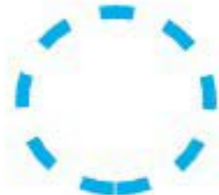

DESIGN INSPIRATION CONTENT OVERVIEW

4.1

VISUAL CONCEPTS

GUIDE TO DIFFERENT AESTHETIC CONCEPTS ENCOURAGING VIBRANT STORE DESIGNS.

4.2

KEY DESIGN ELEMENTS

OVERVIEW OF THE CORE DESIGN ELEMENTS TO EMBRACE WHEN CREATING AN ENLIVENING RETAIL EXPERIENCE.

The vibrant character of great shopping destinations is comprised of exceptional storefronts with texture, color, lighting, graphics and merchandising enlivening the pedestrian experience.

Tenants are encouraged to express their individuality and their brand identity through excellent design by forward thinking design teams.



VISUAL CONCEPTS > OVERVIEW

- ARTISAN
- URBAN
- WHIMSICAL
- INVITING
- ARTSY
- THEATRICAL

This section highlights six design concepts encouraged by Macerich for Tenants looking for additional inspiration. Our Design team welcomes Tenants to engage in these concepts and invites open collaboration in an effort to create store designs that enhance the retail experience.

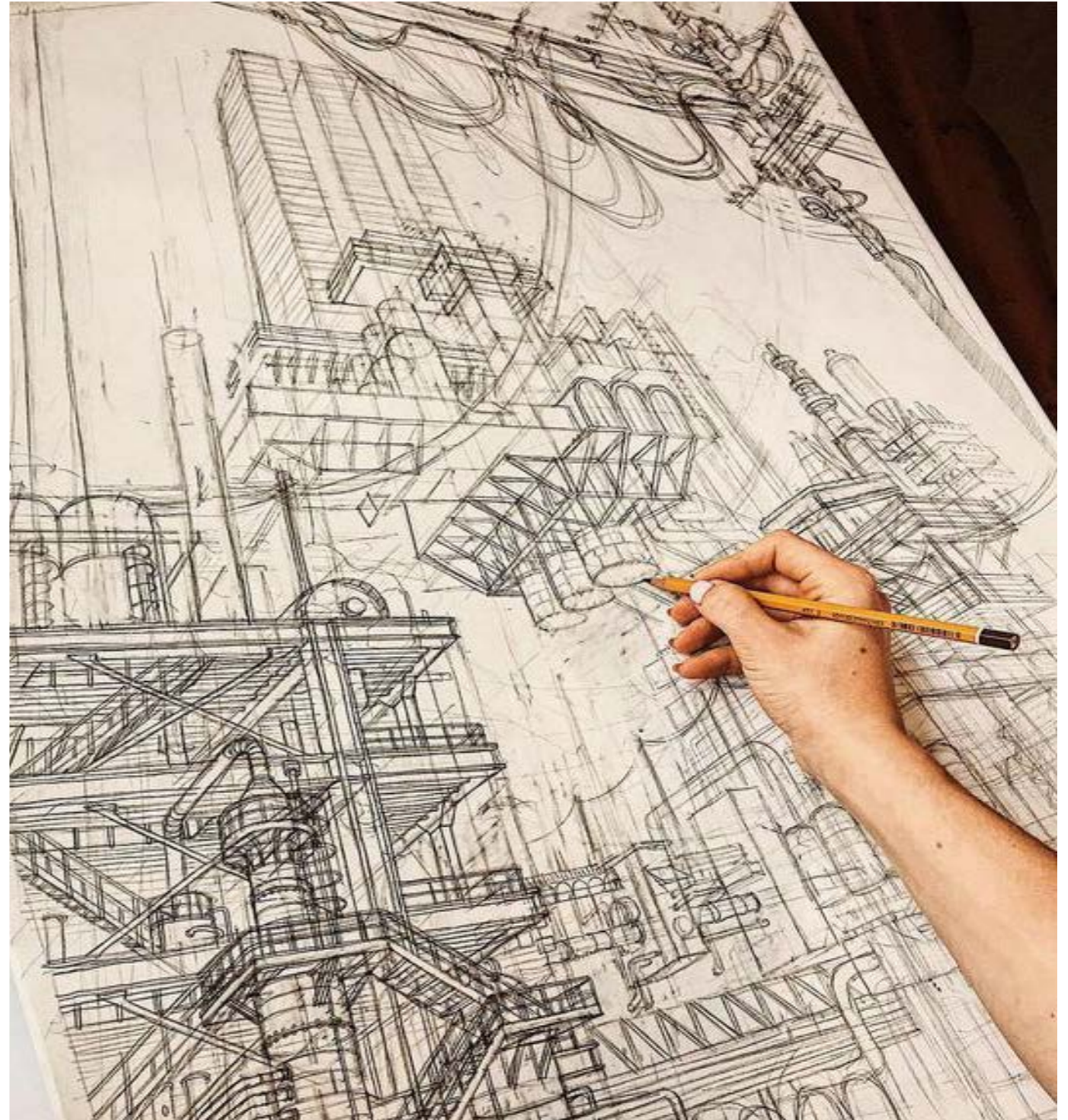

ARTISAN

NATURAL, SOPHISTICATED, UNIQUE



> URBAN

URBAN

EDGY, FUNKY, STREET SAVVY STYLE, INDUSTRIAL

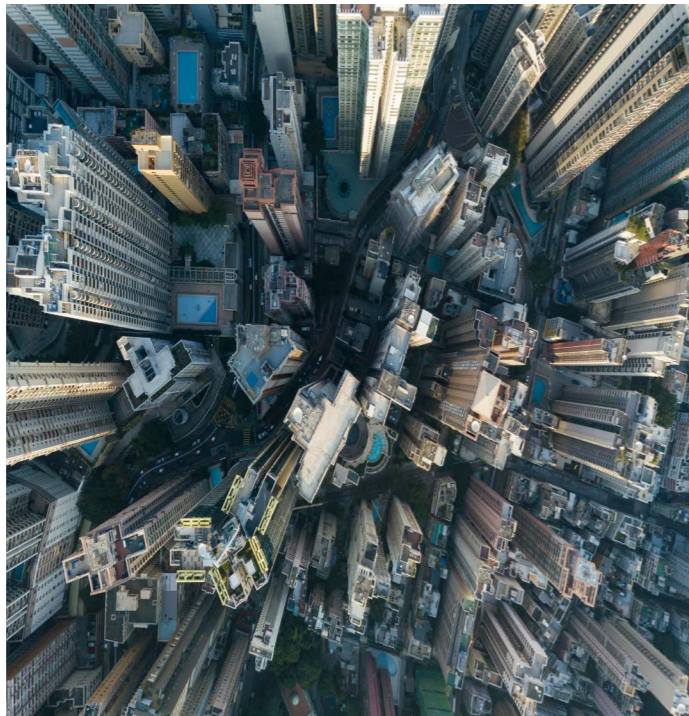

> WHIMSICAL

WHIMSICAL

UNEXPECTED, PLAYFUL, COLORFUL



> INVITING

INVITING
WARM, CALM, OPEN, SOFT



> ARTSY

ARTSY

QUIRKY, AVANT GARDE, SURPRISING



> THEATRICAL

T H E A T R I C A L

DRAMATIC, HIGH CONTRAST, MOVEMENT



KEY DESIGN ELEMENTS > BRANDING / VISUAL MERCHANDISING

Macerich embraces four key design elements to engage Customers and encourage Store traffic and sales. Strong use of textures, colors, lighting, graphics, and merchandising in these elements help draw Customers and invliven the pedestrian experience.

BRANDING

A brand is a name, term, design, symbol, color or some other feature that identifies a seller's product or services as distinct from those of other seller's.

Your branding can be communicated with signage, graphics, materials, shapes, colors, textures, patterns and the overall look and feel of your kiosk, to tell a story and create a lasting experience.



VISUAL MERCHANDISING

Strong visual presentation and merchandising are essential and integral components of retail design.

- Attempt to create triangular composition within style groups or color groups. (display in groups of three or five).
- Start with a center feature, (best sellers and hot items), and merchandise out symmetrically or asymmetrically in a balanced manner.



> LAYERING / TECH AND MEDIA

LAYERING

How can you make a wall / elevation into a canvas for communication to the Customer as they walk towards or by your store?

- Incorporating patterns and textures.
- Overlaying materials to create dimensionality.
- Molding shapes to create softness.
- Overlapping to create shadows and depth.



TECHNOLOGY AND MEDIA

Technology can enhance your online operation by transforming your retail space into a multifunctional one, that lends itself to being an in-store pick up location, payment booth or advertising billboard.

Integrating technology into your Store design can:

- Become an extension of you.
- Supplement your salesforce with interactive screens for ordering, self-design functions and more.
- Keep your business connected with your customer.
- Help you tell a story.
- Help make menu boards easier to update and better communicate your offerings to your Customer via LCD screen loops.

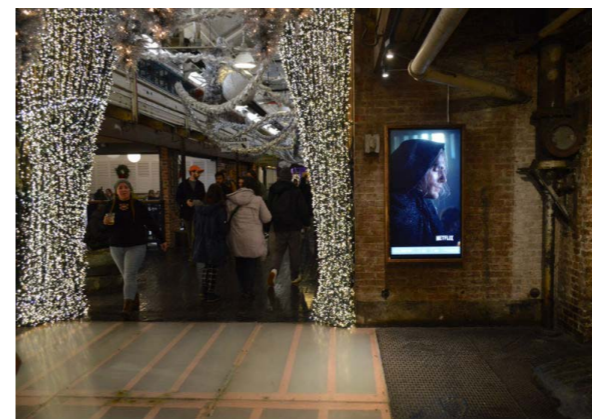

PROPERTY INFO CONTENT OVERVIEW

5.1

ADDRESS & HOURS

LOCATION AND SCHEDULE INFORMATION.

5.2

SITE PLAN

OVERVIEW MAP OF CENTER.

5.3

CONTACTS

MALL CONTACTS, REQUIRED CONTRACTORS, LOCAL MUNICIPALITIES, AND UTILITY CONTACT INFO.

5.4

CODES AND PERMITTING

OVERVIEW OF BUILDING CODE, CLASSIFICATIONS, AND LOCAL PERMITTING.

5.5

UTILITIES

OVERVIEW OF CENTER TYPICALLY AVAILABLE UTILITIES.

5.6

CONSTRUCTION

OVERVIEW OF CONSTRUCTION PROCEDURES.

The Property Info Criteria provides an overview of the Center's building classification, contacts, local permitting, and typically provided utilities.

It is important to note that the Contacts section includes the Center's required contractors. These contractors **must** be used during the design and buildout of your Store.



ADDRESS & HOURS

Fashion Outlets of Niagara Falls is located 30 minutes from the Buffalo Airport. To visit Fashion Outlets take I-190 to Exit 22. Turn right onto Route 62 and then left at the first signal onto Fashion Outlet Boulevard. The Center is open 7 days a week. Open hours for individual restaurants and entertainment venues may vary.

Center Address

Fashion Outlets of Niagara Falls
1900 Military Road
Niagara Falls, NY 14304

Center Hours

Monday - Saturday: 10:00 AM to 9:00 PM
Sunday: 12:00 AM to 6:00 PM



SITE PLAN

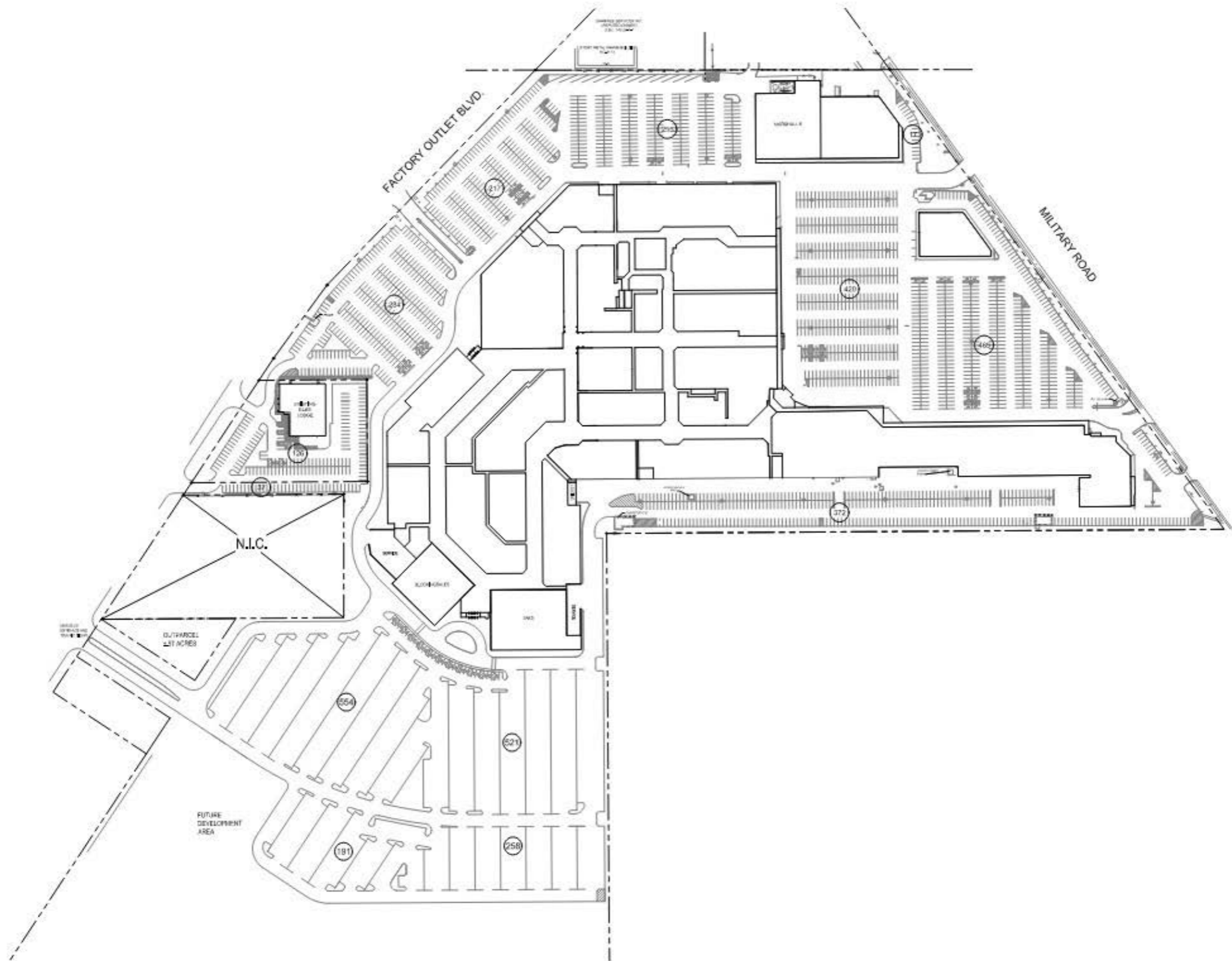

CONTACTS > PROPERTY TEAM / REQUIRED CONTRACTORS

PROPERTY TEAM

The following points of contacts are available to discuss site details and procedures. The primary point of contact for inquiries is the Tenant Coordinator.

PROPERTY MANAGER

John Doran

Phone: (716) 205-1807

john.doran@macerich.com

OPERATIONS MANAGER

Jennifer Miller

Phone: (716) 205-1805

jennifer.miller@macerich.com

TENANT COORDINATION

Jillian Bauer, Tenant Coordinator

Phone: (585) 249-4469

jillian.bauer@macerich.com

LEASING

Teri Furry, AVP, Leasing

Phone: (703) 847-7322

teri.furry@macerich.com

LANDLORD/OWNER

Macerich Niagara LLC

Fashion Outlets II LLC (expansion)

FON Adjacent LLC (vacant Elks Building)

REQUIRED CONTRACTORS

The following points of contacts are the required contractors that must perform the construction for their related field and/or systems. These contractors are required since they have intimate knowledge of the property building systems and can properly interface Tenant systems with the base building infrastructure.

SPRINKLER CONTRACTORS

ABJ Fire Protection

Phone: (716) 884-1442

DATA PROVIDER / LOW VOLTAGE

Granite Services - Rob Norton

Phone: (781) 884-5545

rnorton@granitenet.com

FIRE ALARM CONTRACTOR

Parkside Fire & Security

Phone: (716) 348-3800

ROOFING CONTRACTOR

Blue Ox Roofing

2139 Lockport Road

Niagara Falls, NY 14304

Phone: (716) 731-6671

Barricade

Boston Barricade

NY Local Team

Doug Guerra (GM)

772-257-7330

dguerra@bostonrs.com



CONTACTS > UTILITIES / LOCAL AGENCIES

UTILITIES

The following points of contact are required to set up utility accounts:

ELECTRICAL

National Power Grid Company

Phone: (800) 642-4272

www.nationalgridus.com/niagaramohawk/

DATA

Granite Services - Rob Norton

Phone: (781) 884-5545

rnorton@granitenet.com

Spectrum

Phone: 1-855-261-7308

Verizon

Phone: 1-800-5626-3179

NATURAL GAS

National Fuel Gas Company

Phone: (800) 365-3234

www.natfuel.com

WATER & SEWER

Town of Niagara Water Department

Phone: (716) 297-2150 x123

www.townofniagara.com

LOCAL AGENCIES

The following points of contacts are the local agencies responsible for plan reviews and inspections:

PERMITTING AND BUSINESS REGISTRATION

Town of Niagara

Building Inspector - Charles Haseley

7105 Lockport Road

Niagara Falls, NY 14305

Phone: (716) 297-2150

www.townofniagara.com

HEALTH AUTHORITY

Niagara County Health Department Environmental Division

Public Health Sanitarian - Scott Acker

5467 Upper Mounain Road, #100

Lockport, NY 14094-1894

Phone: (716) 439-7582

www.niagaracounty.com

SALES TAX REGISTRATION

New York State Governor's Office of Regulatory Reform

Empire State PLaza Agency Building 1, 4th Floor

PO Box 2107

Albany, NY 12220-0107

Phone: (800) 342-3464

www.nys-opal.com

LIQUOR LICENSING AUTHORITY

State Liquor Authority

Phone: (716) 847-3035

www.abc.state.ny.us/



CODES AND PERMITTING

BUILDING CODE OVERVIEW

Fashion Outlets of Niagara Falls offers spaces for retail, restaurants, and entertainment. Below are the pertinent property details related to local building codes. It is the sole responsibility of the Tenant’s Architect, Engineers, Consultants, and Contractors to comply with all applicable federal, state, and local codes and ordinances for their occupancy type.

Building Type

Type II-B

Construction Classification

Mercantile

Applicable Codes

The Building Code of New York State 2002 issue is administered, amended, and interpreted by The New York State Department of State, Division of Code Enforcement and Administration.

The Building Code of New York State combines language from the 2000 International Building Code, 2001 Supplement to the International Building Code, and New York modifications developed by the State Fire Prevention and Building Code Council and its Building Code Technical Subcommittee. In addition, administrative modifications to the 2000 International Building Code were developed by the Department of States Administrative Task Group.

The Building Code for the State of New York was formally adopted by the State Fire Prevention and Building Code Council on March 6, 2002 and has an effective date of July 3, 2002.

PERMITTING

Completion of Application Form Application for a Town of Niagara Building permit can be made by the Tenant, the Tenant’s contractor, or anyone authorized to represent the Tenant as an Owner-Agent. The Application for Permit is available online. Correct completion of the application is important to prevent permit delays.

Please note the following when completing the Application for Building Permit:

APPLICANT - anyone authorized as an agent of the Tenant.

ADDRESS OF PROJECT – the street address of the Tenant’s Lease space in which the improvements shall occur (not the space number).

OWNER OF PROJECT SITE – Macerich Niagara LLC
Fashion Outlets II LLC (expansion)
FON Adjacent LLC (vacant Elks bldg.).

NAME & ADDRESS OF CONTRACTORS – if the contractors have not been selected and the plans are out to bid, the contractors can be listed as TBD (to be determined). The contractors must be determined and fulfill certain requirements before the permit is issued.

SURVEY – not required unless the Tenant work changes the footprint of the building.

DESCRIPTION OF WORK – alter and/or demolish.

USE – commercial.

SIZE OF STRUCTURE – provide dimensions of the Tenant’s Premises.

PERMIT SUBMITTAL REQUIREMENTS

- The application along with three sets of plans signed and sealed by a New York licensed architect and engineer are required for submittal. Only plans approved by the Landlord during the design review process may be submitted for permit. The Town of Niagara requires that the Landlord authorizes the Tenant in writing to apply for the permit. Written authorization can be obtained from the Tenant Coordinator.
- The following is a checklist of the requirements for Tenant submission to the Town of Niagara for permit.
- Letter from the Property Owner, Talisman, authorizing the Tenant to file for building permit.
- Completed Application for Building Permit.
- If application is made by someone other than the Tenant himself, a letter from the Tenant authorizing the applicant as the Tenant’s Owner-Agent is required.
- Three (3) copies of complete plans signed and sealed by a New York licensed architect and engineer.



PERMITTING AND BUSINESS REGISTRATION

ISSUANCE OF PERMIT

Permits can take three weeks for approval, but the timing is dependent on the Town of Niagara's permit load and the quality and completeness of the Tenant plans. Upon approval of the permit plans the applicant shall be notified that the permit is ready to be issued to the Tenant's general contractor. Except for asbestos abatement work, all construction work in New York is regulated at the local level.

The Town of Niagara has certain minimal requirements for the Tenant's general contractor:

- Register with the Town of Niagara by making an Application for Business Registration. (New Business Registration Form is available online.)
- Provide a copy of the DBA or Articles of Incorporation and federal tax ID number.
- Provide proof of insurance.
- When the permit is issued one set of plans shall be returned to the applicant, one set is kept for the Town of Niagara's file, and one set is used for inspections.

SIGN PERMITS

Sign permits are required for exterior building signs, pole, and pylon signs only. The Tenant or the sign manufacturer shall submit the plans for permit only after having obtained the Landlord's approval for the proposed Tenant signs.

Signed and sealed plans are only required for pole mounted signs or new sign structures not for building mounted signs.

The permit fee is \$10. The application for permit must be accompanied by a letter of authorization from the Property Owner, Macerich Niagara, LLC. Renewal of the permit is required annually.

Interior Tenant signs do not require a separate permit provided the sign is shown on the Tenant improvement plans and includes the electrical connection to the Tenant panel if it is a lit sign.

HEALTH DEPARTMENT REVIEW – FOOD SERVICE TENANTS ONLY

Food service Tenants are required to submit for plan review to the Niagara County Health Department, Environmental Division in accordance with the Niagara County Sanitary Code. An application with fee and an inspection are necessary to obtain a permit and operate a food service establishment in Niagara County. The application and more information can be obtained by contacting Scott Acker at (716) 439-7579.

One set of plans shall be delivered to Scott Acker, the assigned Public Health Sanitarian for Niagara Falls for review. The plans do not need to be the complete set of permit or construction documents, but they must include a kitchen equipment plan, plumbing plan, and a fixture and food service equipment schedule. The review fee ranges from \$150 to \$300 and is determined by risk assessment based on the type of menu served.

SALES TAX REGISTRATION

A step by step guide and application to obtain a Certificate of Authority to Collect Sales Tax is available online at www.nys-opal.com.

The New York State Governor's Office of Regulatory Reform has Toll-free telephone service (800) 342-3464 providing recorded information on business topics 24 hours a day. Permit Coordinators are available to answer business inquiries Monday through Friday from 9:00 am - 5:00 pm (except holidays).

The sales tax registration must be obtained, and proof of registration provided to the Town of Niagara for Business Registration.

BUSINESS REGISTRATION

All new businesses shall be registered with the Town of Niagara. The application is available online or at the Town of Niagara. Copy of DBA or Articles of Incorporation and federal tax ID number and sales tax registration are required. Applications are to be accompanied by a \$50 application fee and are made in person at the Town of Niagara. Business registration is renewed annually.

BURGLAR ALARM REGISTRATION

Burglar alarms are registered at the Town of Niagara with the Town Clerk. The registration fee is \$25 and renewable annually. A decal for the Tenant storefront is issued with a registration number. In case of emergency, fire or police may obtain the owner's contact information with the registration number to avoid breaking storefront glass to gain entry.



UTILITIES AND SERVICES

SITE UTILITIES AND SERVICES

The following is an overview of the utilities and services typically available for inline retail spaces. Please refer to lease language for any agreed upon changes that may overwrite these typical service provisions. It is the Tenant's responsibility to verify existing conditions and comply with all applicable codes and standards for all Technical systems.

I. ELECTRICITY

Landlord will furnish and install the main disconnect and meter socket in Landlord's electric room at 277/480V. One empty conduit with pull string will be stubbed in Tenant's premises from the electric room.

II. DATA AND COMMUNICATIONS

Tenant shell spaces typically provide a conduit with pull string to nearest rack.

III. SPRINKLER SYSTEM

Tenant shell spaces typically provide an automatic sprinkler system according to NFPA guidelines.

Tenants are responsible for contracting with the Landlord's required sprinkler vendor to adjust any existing grids, or install new if none exist, and tie into the main system.

IV. WATER

Tenant shell spaces typically provide domestic cold water stubbed into the space. Size and location of the pipe varies per space. Spaces also typically provide a sanitary line stubbed into the space or located under the floor slab. Size and location of the line varied per space.

V. HVAC

Landlord provides all-electric roof top mounted single packaged heating and cooling unit sized approximately one ton per 350 square feet of space. An empty conduit will be provided from the Tenant's premises to the RTU. Power to the unit and start up are Tenant's responsibility.

VI. GAS

Gas is available for some retailers depending on location. Gas is available in the original building. Gas is unavailable in the building expansion. Tenants in the expansion shall use electric heat.



CONSTRUCTION > PRE-CONSTRUCTION

CONSTRUCTION

The following is a brief overview of the construction process and requirements for a tenant build outs:

TENANT BIDS CONSTRUCTION

As soon as plans are approved by the Landlord, the Tenant shall put the approved final plans out to bid or negotiate with general contractors who meet the Landlord's pre-construction requirements as defined by the Tenant Contractors' Construction Guidelines. It is the Tenant's responsibility to qualify the bidders to verify that they meet the Landlord's requirements for work on the Landlord's property and bid the project in such a way as to comply with the Landlord's rules, regulations and requirements. The Tenant may provide the bidders with the Tenant Project Manager's name and contact number to schedule on site verification of the conditions of the Premises by the general contractor and its sub-contractors.

TENANT SELECTS GENERAL CONTRACTOR

The Tenant shall notify the Landlord of the general contractor's name and contact number and provide a copy of the Tenant's construction contract for the Landlord's review. The Landlord shall have the right to disapprove the contractor on reasonable grounds.

The Tenant may submit for permit without having selected the contractor and awarding the construction contract. The Town of Niagara will only issue a permit for the Tenant's construction to a registered contractor.

PRE-CONSTRUCTION REQUIREMENTS

Prior to starting construction, the Tenant's general contractor must meet certain pre-construction requirements. Any submittals that are incorrect or incomplete will delay turnover of the Tenant Premises to the Tenant contractor until corrections are made. The submittal requirements are described in detail in the Tenant Contractors' Construction Requirements section of the Tenant Package.

No Tenant can begin work without the Tenant's contractor first having a pre-construction meeting with the Landlord and having paid in full the construction deposit. During the pre-construction meeting the Landlord shall locate the utility connection points in the Premises; identify contractor parking area, construction dumpster locations, delivery access points; and review the rules, regulations, and requirements to facilitate a smooth construction process.

The Landlord and contractor shall sign a work release in which the Landlord acknowledges receipt of the pre-construction requirements and the Contractor acknowledges that he is familiar with the Tenant Contractors' Construction Criteria and will enforce the rules and regulations on his construction site. The Tenant Contractor is expected to abide by the Landlord's rules and regulations and to work cooperatively side by side with the Landlord's Contractors, other Tenant Contractors, and Tenants who are open for business within the operating center.

Required pre-construction documents include:

- Landlord Approved Construction Documents
- Contractors Rules & Regulations to be completed and signed in full
- Approved GC Certificate of Insurance
- A copy of the Building Permit issued by the City
- General Contractor's state license
- Construction Progress Schedule
- Subcontractor List (include associated trade, contact name and phone number)

The Landlord will send a Preparedness Letter detailing the fees required for collection prior to scheduling this pre-construction meeting. Contractor Rules and Regulations are linked in the Addendum.

If applicable, a barricade must be constructed prior to any demolition or start of any construction. The barricade must be constructed according to the Landlord's specifications as described in the Tenant Contractors' Construction Guidelines.

From the date construction begins in the Premises, the Tenant must have all utility meters registered in the Tenant's name including water and sewer, electric, gas, cable, and telephone. In the event permanent services are not made available to the Tenant for and during construction, including lighting, power, and water (but excluding any and all power for use in heating and air conditioning the Premises), temporary services may be obtained if available at the Tenant's expense, the amount being payable to the Landlord on demand.



CONSTRUCTION > BUILD OUT AND OPENING

CONSTRUCTION PERIOD

The maximum duration of the construction period is defined by the Lease. The Landlord shall work with the Tenant contractor to facilitate the construction of the Tenant improvements. The Landlord shall coordinate the Tenant work with the Landlord's contractors and required sprinkler, roofing, and fire alarm contractors; coordinate shut down and tie-in to Landlord systems; and coordinate access for Tenant work and debris removal. The Tenant Contractors' Construction Guidelines covers the Landlord's rules, regulations, and requirements for work in the premises.

The Tenant contractor shall confirm that the conditions as shown within the approved construction documents are correct. Unforeseen, concealed conditions should be immediately brought to the attention of the Landlord for consideration and, if necessary, resolution in compliance with the requirements and obligations as set forth in the Lease Agreement with the Tenant.

After all inspections are complete, fire sprinkler as-builts and calculations and a certified HVAC Test and Balance Report is provided, and any other Town of Niagara requirements are met, it shall issue a Certificate of Occupancy. The Tenant's contractor shall provide a copy of the final and unconditional Certificate of Occupancy to the Landlord, and the Tenant shall post a copy within the Tenant Premises.

MERCHANDISING

The Tenant may not begin merchandising the space until a final and unconditional Certificate of Occupancy is obtained from the Town of Niagara to insure that all Life Safety System requirements have been satisfied, and it is safe for the Tenant to occupy the space. In some cases, the Town of Niagara may issue a Temporary certificate of Occupancy and permit merchandising.

The Tenant shall schedule merchandise deliveries with the Landlord and coordinate access if not through a rear service door. The Tenant shall provide dumpsters for the removal of merchandising debris at the Tenant's expense. The location of the dumpster shall be coordinated with the Landlord. The Tenant shall protect the Landlord's paving from any damage which may occur during the setting and removal of the dumpster.

The Tenant is responsible for removal of all debris from the Tenant's Premises. At no time may debris be stockpiled at the rear service door, in service corridors, in the common area, or outside of the dumpster.

Any merchandising that is scheduled to occur after 11:00 pm and before 8:00am shall be scheduled with the Landlord with 24 hours' notice. The Tenant is responsible for security at a cost of \$25 per hour during of-hours.

The Tenant's employees may not park in loading areas during merchandising. Vehicles must be moved to employee designated parking areas after unloading.

TENANT OPENING

The Tenant shall notify the Landlord of the anticipated opening date. It is the Tenant's responsibility to confirm with the Landlord that all Lease obligations have been met, all advanced rent has been paid, and that there are no outstanding requirements for opening.

The Tenant may not open for business until the Tenant has provided the Landlord with an insurance certificate demonstrating the coverage and limits set forth in the Lease.

Prior to opening for business, the Town of Niagara requires that the Tenant has completed the following:

- Obtained a Certificate of Occupancy from the Town of Niagara.
- Completed new Business Registration with the Town of Niagara. The registration fee is \$25 and renewable annually.
- Permitted all exterior signs, if applicable with the Town of Niagara. The permit fee is \$10 and renewable annually.
- Registered the burglar alarm, if applicable with the Town Clerk. The registration fee is \$10 and renewable annually.
- Copies of the Certificate of Occupancy and all registrations and licenses shall be kept on site and available for inspection by the Landlord, Town of Niagara, or other authority having jurisdiction over Tenant compliance.

The Tenant is required to complete a Landlord punch list and provide the Landlord with certain documents upon completion of the Tenant improvements and opening for business. Some items may be provided by the Tenant Contractor but is ultimately the Tenant's responsibility to confirm receipt by the Landlord of all items.



CONSTRUCTION > CLOSEOUT

TENANT CLOSE-OUT PACKAGE

The Tenant shall provide the following package of information to the Landlord's Tenant Coordinator to complete the Tenant's obligations:

- Exhibit B executed Tenant's Estoppel Certificate.
- Copy of the permanent and unconditional Certificate of Occupancy issued by the Town of Niagara.
- Notarized, sworn statement containing the complete list of names, addresses, telephone numbers, and contract amounts for all contractors, subcontractors, vendors, and suppliers providing materials and labor for the Tenant's work.
- Copy of the Tenant's construction contract in accordance with Lease Exhibit C, Section V.
- Original lien waivers from all parties supplying labor and materials over \$5,000 for Tenant's work which are notarized and unconditional using only the form provided in the Tenant Package.
- Copies of all building permits and permit inspection card indicating inspection and approval by the issuer.
- Written certification by the architect of record that the work is complete, and the Premises have been constructed in accordance with the Tenant's approved plans, Exhibit C, and Legal Requirements.
- Confirmation that the Tenant's contractor has completed the punch list, provided the Close-Out Package, and settled all accounts with the Landlord.

CONTRACTOR PUNCHLIST

Upon completion of the Tenant work the Tenant contractor shall notify the Landlord that he is ready for the Landlord to inspect the contractor's work and to create a punch list of all construction items to be repaired and completed for close out of the Tenant construction. Any punch list items that are not satisfactorily completed by the Tenant contractor may be completed by the Landlord at the Landlord's option, the cost of which shall be deducted from the construction deposit.

CONTRACTOR CLOSE-OUT PACKAGE

The Tenant contractor shall submit the following items to the Landlord in a tabbed binder with a copy to the Tenant:

- Copy of the permanent and unconditional Certificate of Occupancy issued by the Town of Niagara.
- Copies of all building permits and permit inspection card indicating inspection and approval by the issuer.
- Updated and complete list of contractors, subcontractors, and suppliers who supplied labor or materials for the Tenant improvements including contact names, phone numbers, and addresses.
- Original lien waivers from all parties supplying labor and materials for Tenant's work which are notarized and unconditional using only the form provided in the Tenant Package.
- One-year minimum warranties from the Tenant's contractor and sub-contractors.
- Accurate as-builts of Tenant construction in the form of electronic files saved to disc and one hard copy.
- Certified HVAC Test and Balance Report.
- Fire sprinkler shop drawings and calculations.

REIMBURSEMENT OF THE CONSTRUCTION DEPOSIT

After completion of the punch list and receipt of the Close-Out Package, the Landlord shall compile any charge backs for work performed by the Landlord at the Tenant's expense and fees or fines for violations by the Tenant Contractor and reconcile them against the construction deposit. The Landlord shall notify the Tenant contractor of the remaining balance and accept a written request from the contractor for reimbursement. The remaining construction deposit shall be reimbursed within 30 days.



SUBMITTAL CRITERIA CONTENT OVERVIEW

6.1

CONSTRUCTION DOCUMENTS

SUBMITTAL REQUIREMENTS FOR ARCHITECTURAL AND TECHNICAL DESIGN DOCUMENTS.

6.2

SIGNAGE DRAWINGS

SUBMITTAL REQUIREMENTS FOR PRIMARY AND SECONDARY STOREFRONT SIGN DESIGNS.

The Submittals Criteria highlights the Landlord review process and drawing submittal requirements to ensure a quick and smooth drawing review for your design and Construction Documents.

Tenant construction and signage drawings must be reviewed and Approved by the Landlord before the drawings can be submitted for permit. Permits from the local Municipality are required for all incoming Tenant construction and signage.

It is always the Tenant's responsibility to ensure:

- Compliance with the Lease document.
- Field verification of conditions and dimensions.
- Discrepancies between the drawings and the as-build conditions.
- Coordination with trades to ensure compliance with all local and national codes.



CONSTRUCTION DOCUMENTS > PROCESS & TIMELINE

DRAWING REVIEW PROCESS

Drawing reviews are required to be submitted in two stages for Landlord review; Preliminary and final Construction Documents. Preliminary drawings are required to ensure the design process moves quickly by ensuring that all Criteria requirements are understood and adopted early in the design. This helps ensure an expedited review of the final Construction Documents.

REVIEW TIMELINE

Step	Action	Time Period
1	Tenant submits preliminary design.	Required 20 days after Lease Execution or 10 days following previous submittal disapproval.
2	Landlord Approved Preliminary Design.	15 days after confirmed completion of Step #1.
3	Tenant submits final construction drawings.	Required 20 days after Tenant Coordinator approval at Step #2.
4	Landlord Approves final documents.	15 days after completion of Step #3.
5	Tenant submits drawings for permit. (If applicable)	5 days after confirmed completion of Step #4.
6	Tenant responds to any requests from or comments by permitting jurisdiction.	5 days.
7	Upon permit review approval, Tenant pays all fees and logs out permit.	5 days.



> SUBMITTAL REQUIREMENTS > PRELIMINARY

PRELIMINARY DESIGN SUBMITTAL

The Preliminary Document review process will evaluate all the criteria discussed in this manual, including overall three-dimensional form, degree of design uniqueness and identity, use and detailing of materials, colors and lighting, and integration of signage and graphics.

Submittals are to provide the reviewer with a clear understanding of proposed design concepts.

The submission must be complete in order to fairly evaluate the proposal and prevent continuation of work on an unacceptable design.

Tenant shall submit to Landlord an electronic PDF files of the following:

- **Color and Material Sample Board**
Include actual samples of all Tenant colors and materials visible to the public, on a digital sample board. Clearly label all materials and reference to floor plan elevations.
- **Perspective and/or Photo Image(s)**
Colored perspective rendering and/or prototypical photo images of the proposed storefront, including graphics and signage.
- **Cover Sheet**
Include: Name of Tenant, name of Mall or Center, space number, Applicable Codes, Building Type and Occupancy Type, Leased square footage, and Key Plan
- **Floor Plan**
¼" Scale Minimum showing: Entire lease dimensioned space with room names, floor finishes, casework and fixture locations.
- **Reflected Ceiling Plan**
¼" Scale Minimum showing: Lighting design, including fixture types and locations, signage, access panels, Overhead projections such as light coves and fascia systems, and Entrance.
- **Sections**
1" Scale Minimum showing: Entry, Display windows and fascia, Sign integration into storefront design.
- **Storefront Elevations**
½ Scale Minimum showing: Exterior views - front and sides, Signs, graphics, logos.

Copies of all drawings are to be sent to the Tenant Coordinator via email.

A physical sample board is also required, mounted on foam core or card stock to be sent in coordination with your Tenant Coordinator.



> SUBMITTAL REQUIREMENTS > FINAL

FINAL DRAWING SUBMITTAL

After Preliminary Drawing Approval, it is critical to quickly complete and submit Final Construction Documents for Landlord review.

If any questions arise from the Tenant's interpretation of the design and criteria information, the Tenant shall assume all responsibility for clarification by written request to the Tenant Coordinator. The Landlord plan review and approval process is independent of local permitting for construction. The Tenant is responsible for procurement and compliance with local, state and federal codes and requirements.

Tenant shall submit to Landlord an electronic PDF files of the following:

- **Responsibility Schedule**
Any work, which is the Landlord's responsibility, must be listed clearly on a responsibility schedule on the cover sheet.
- **Cover sheet**
Include a Key Plan, Name of Tenant, name of Mall or Center, space number and location leased premises within Mall or Center, Applicable codes, building type and occupancy type, Leased square footage, Responsibility schedule, and Drawing index.
- **Floor Plans**
¼" Scale Minimum showing: Entire lease space with room names, Floor finishes, casework and fixture locations, and Demolition plan.
- **Reflected Ceiling Plan**
¼" Scale Minimum showing: Complete lighting design, including fixture types and locations, signage, access panels, Overhead projections such as light coves and fascia system, Entry, Connection to Landlord's work, Tenant's framing and/or additional structure showing freestanding from Landlord's structure.
- **Sections**
1" Scale Minimum showing: Entry, Display windows and fascia, Sign integration into storefront design, Connection to Landlord's work, Tenant's framing and/or additional structure showing freestanding from Landlord's structure.
- **Interior Elevations**
¼" Scale Minimum showing: All sales floor interior views, Built-in casework, signage, and display systems.
- **Storefront Elevations**
½" Scale Minimum showing: Exterior views - front and sides, Signs, graphics, logos, Landlord neutral piers, Storefront finishes (to be referenced to finish schedule)
- **Architectural Details**
½" Scale Minimum.
- **Door Schedule**
Include floor transition details and anti-theft security system details.
- **Details, Catalogue Cut Sheets, and Fixture Finishes**
- **Finish & Color Schedule**

Copies of all drawings are to be sent to the Tenant Coordinator via email.



> SUBMITTAL REQUIREMENTS > FINAL ENGINEERING

FINAL DRAWING SUBMITTAL - ENGINEERING DRAWINGS

The Landlord does not review for mechanical, electrical, plumbing, or structural design, nor does the Landlord accept responsibility for the Tenant's adherence to governing codes.

Tenant shall submit to Landlord an electronic PDF files of the following engineering drawings included in the final drawing set:

I. MECHANICAL DESIGN DOCUMENTS

- Make, type, and performance of all equipment.
- Sign and seal by a Licensed Engineer in the state where the Shopping Center is located.
- Calculations showing the heating and cooling required, including transmission and ventilation losses in the space, and heat and cooling provided for the ventilation supply, and exhaust required for the space. Calculations must be performed in accordance with the latest ASHRAE standards and tabulated in a concise, orderly manner.
- Temperature control system data showing make, control, and energy management systems.
- Exhaust system layout including CFM and equipment specifications.
- Reflected ceiling plan showing HVAC equipment.
- Roof plan with equipment locations.
- Structural details for support of all rooftop equipment and equipment suspended from the steel structure.

II. PLUMBING DESIGN DOCUMENTS

- Make, type, and performance of all equipment.
- Sign and seal by a Licensed Engineer in the state where the Shopping Center is located.
- Complete plumbing system design and floor plan for the Tenant space including, but not limited to the toilets, sinks, urinals, drains, hot water heaters, water coolers, grease trap/interceptors and connections into existing water and sewer lines.
- Single line diagram.
- Fixture schedule.
- Water heater detail as applicable.
- Grease trap cut sheets as applicable.

III. FIRE PROTECTION / SMOKE EVACUATION DESIGN DOCUMENTS

- Reflected ceiling plan, with revised sprinkler head locations.
- Design must be City approved before construction

IV. ELECTRIC DESIGN DOCUMENTS

- Sign and seal by a Licensed Engineer in the state where the Shopping Center is located.
- Panel schedules, load calculations, and meter information, if applicable.
- Structural drawings for all equipment that will be suspended from the steel structure.
- Electrical load summary and Title 24 Energy Calculations (for State of California).
- Floor plan depicting equipment locations and branch circuitry.
- Reflected ceiling plan depicting the layout of light fixtures.
- System one line diagrams.
- Lighting fixture schedule.
- Equipment legend.

V. STRUCTURAL DESIGN DOCUMENTS

- Design elements affecting the structure of the base building.
- Alterations, additions, modifications and reinforcements to the base building which shall be required to accommodate Tenant's Work.
- All calculations & details (Include ICBO numbers on all framing details, Seismic bracing details for State of California.)
- All forms required by governmental agencies and Governmental Regulations, fully and properly completed and executed by Tenant.
- Partial structural framing plan showing existing conditions for new and existing rooftop installations and proposed reinforcement, which shall be accompanied by structural engineers' calculations, drawn on a scale of 1/2"=1'0".
- Ceiling, soffits, storefront attachment details to existing base building.
- A letter from a state-registered structural engineer certifying that all new equipment and design elements serving the Premises are adequately supported to carry the new load.



SIGNAGE DRAWINGS > PROCESS & TIMELINE

DRAWING REVIEW PROCESS

Sign drawing reviews are required to be submitted in two stages for Landlord review; Preliminary and final Construction Documents. Preliminary drawings are required to ensure the design process moves quickly by ensuring that all Criteria requirements are understood and adopted early in the design. This helps ensure an expedited review of the final Construction Documents.

REVIEW TIMELINE

Step	Action	Time Period
1	Tenant submits preliminary design.	Required 20 days after Lease Execution or 10 days following previous submittal disapproval.
2	Landlord Approved Preliminary Design.	15 days after confirmed completion of Step #1.
3	Tenant submits final Construction Documents.	Required 20 days after Tenant Coordinator approval at Step #2.
4	Landlord Approves final documents.	15 days after completion of Step #3.
5	Tenant submits drawings for permit.	5 days after confirmed completion of Step #4.



> SUBMITTAL REQUIREMENTS > PRELIMINARY, FINAL

PRELIMINARY DESIGN SUBMITTAL

The Preliminary Document review is intended to acquaint the Landlord with the Tenant's signage design intent.

Submittals are to provide the reviewer with a clear understanding of proposed design concepts.

The submission must be complete in order to fairly evaluate the proposal and prevent continuation of work on an unacceptable design.

Tenant's licensed sign contractor shall submit to the Center's Tenant Coordinator electronic PDF files of the following:

- **Perspective and/or Photo Image(s)**
Colored perspective rendering and/or prototypical photo images of the proposed storefront, including graphics and signage.
- **Storefront Elevations**
½ Scale Minimum showing: Exterior views - front and sides, Signs, graphics, and logos highlighting sign dimensions and materials.

FINAL DRAWING SUBMITTAL

After Preliminary Drawing Approval, it is critical to quickly complete and submit Final Construction Documents for Landlord review.

If any questions arise from the Tenant's interpretation of the design and criteria information, the Tenant shall assume all responsibility for clarification by written request to the Tenant Coordinator. The Landlord plan review and approval process is independent of local permitting for construction. The Tenant is responsible for procurement and compliance with local, state and federal codes and requirements.

The Landlord does not accept responsibility for the Tenant's adherence to governing codes or verification of job site conditions.

Tenant's licensed sign contractor shall submit to the Center's Tenant Coordinator electronic PDF files of the following:

- Elevation of the storefront including signage and graphics; showing all doors, architectural features, etc., and fully detailed/dimensioned sections and details through the storefront.
- These fully detailed and dimensioned drawings shall be drawn to scale as noted:
 - Storefront Plan, Elevation and Sectional views at 1/2 inch scale.
 - Details of the Signage at 1/2 inch scale or larger.
 - Storefront Signage at 1/2 inch scale.
- Letter style and typeface specifics.
- Color and finish qualities of all portions of signage.
- Material specifications and thickness.
- Transformer specifications, including input and output voltage of transformers. PK housing, (or other UL approved insulating sleeve approved by Landlord and local building codes), is required for all through wall penetrations and must be indicated on the sign shop drawings. Wiring specifications.
- Locations of service switches, access panels and transformers. NONE of these items shall be visible to the public from any portion of the Mall.
- Neon tube specifications, including color and dimension (in mm) of tubes to be used.
- Type of lamps.
- Mounting hardware.



ADDENDUM LINKS

This Addendum contains links to supplemental documents of specific requirements and information. These documents are considered part of the Tenant Criteria Package. Clicking the links below will navigate to the described documents. It is the responsibility of the Tenant, its contractors, subcontractors, architects, engineers, employees, and agents to comply with terms of the Tenant Criteria, Addendum included.

GLOSSARY

I. [GLOSSARY OF TERMS](#)

Defines commonly used terms for clarity.

DESIGN ADDENDUM

I. [MACERICH SUSTAINABILITY HANDBOOK](#)

Guide to encourage energy efficient, sustainable design.

II. [UNIT UTILITIES AS BUILT CHECK LIST](#)

Helpful checklist for reference during a site survey.

III. [SPECIALTY LEASING CRITERIA](#)

Design requirements for temporary Tenant's buildout and signage.

BARRICADE ADDENDUM

I. [BARRICADE GUIDELINES](#)

Guide to installing and activating construction barricades with graphics.

CONSTRUCTION ADDENDUM

I. [CONTRACTOR RULES AND REGULATIONS](#)

Document detailing the rules and regulations Tenant contractors must adhere to during their construction. This document must be reviewed and signed by the Site Superintendent overseeing the Tenant build out.

II. [HOT WORK PERMIT](#)

Required form to submit when construction required hot work.

III. [PUNCH LIST](#)

Reference Landlord Punchlist that that Landlord will use to inspect and confirm completion of Tenant construction.

