



MACERICH®

KIOSK CRITERIA

02.20.25

KIOSK CRITERIA CONTENT OVERVIEW

1.1

DESIGN INSPIRATION

PROVIDES DESIGN INSPIRATIONS AS TO WHAT KIND OF KIOSK DESIGNS CAN BE PRODUCED.

1.2

DESIGN ELEMENTS AND REQUIREMENTS

DETAILS DESIGN CONCEPTS AND REQUIREMENTS TO INCOPORATE INTO THE OVERALL KIOSK DESIGN.

1.3

FOOD DESIGN ELEMENTS AND REQUIREMENTS

DETAILS SPECIFIC DESIGN ELEMENTS AND REQUIREMENTS FOR KIOSKS SELLING AND COOKING FOOD.

1.4

TECHNICAL

DETAILS THE TECHNICAL DESIGN REQUIREMENTS TO INSURE THE KIOSK INSTALLATION INTERFACES WITH THE UTILITIES AT THE CENTER.

1.5

PROCESS

PROVIDES AN OVERVIEW OF THE DESIGN, CONSTRUCTION, AND INSTALLATION OF KIOSKS.

2.0

SUBMITTALS

REQUIREMENTS TO SUBMIT CONSTRUCTION DRAWINGS, RENDERS, SIGN DRAWINGS, AND MATERIAL BOARDS.

3.0

ADDENDUM

SUPPLEMENTAL DESIGN AND CONSTRUCTION REQUIREMENTS AND DETAILS PROVIDED AS LINKS TO EXTERNAL DOCUMENTS.

Macerich strives to differentiate its shopping environment through fresh, innovative design and unique retail offerings. We transform everyday shopping into a truly unexpected and exhilarating experience.

Innovative design has proven to stimulate customer interest which in turn drives sales. For Macerich and kiosk Tenants to achieve this goal, we ask our tenants to fabricate a high quality, experiential retail design that is cohesive and complimentary to the overall shopping center environment.



DESIGN INSPIRATION > CONTENTS

- URBAN
- ARTISAN
- WHIMSICAL
- INVITING
- ARTSY
- THEATRICAL

GET INSPIRED!

The following inspirations are intended to help you visualize what kind of kiosk design can be produced. These aesthetic examples encourage bold design to draw Customers and enliven the common area visuals of the Center. By the nature of their prominent locations, kiosks require great design and an attention to detail to ensure high quality retail experiences.

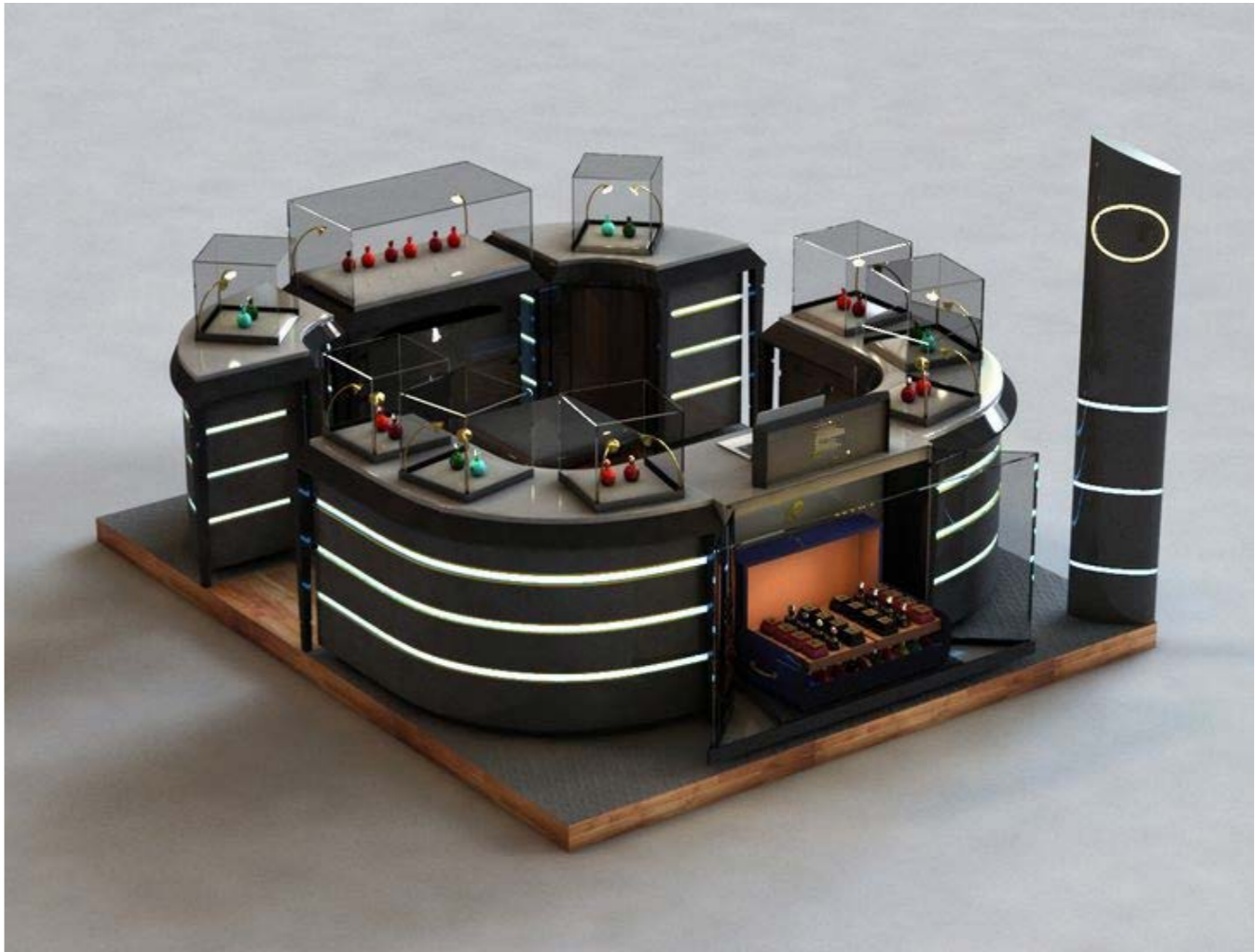

> URBAN

URBAN

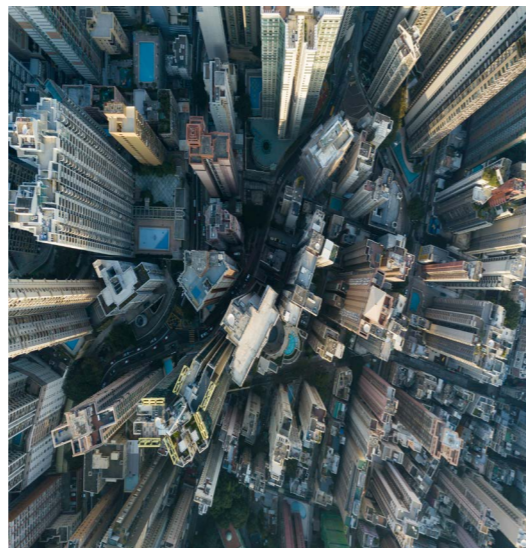

EDGY, FUNKY, STREET SAVVY STYLE, INDUSTRIAL

> ARTISAN

ARTISAN

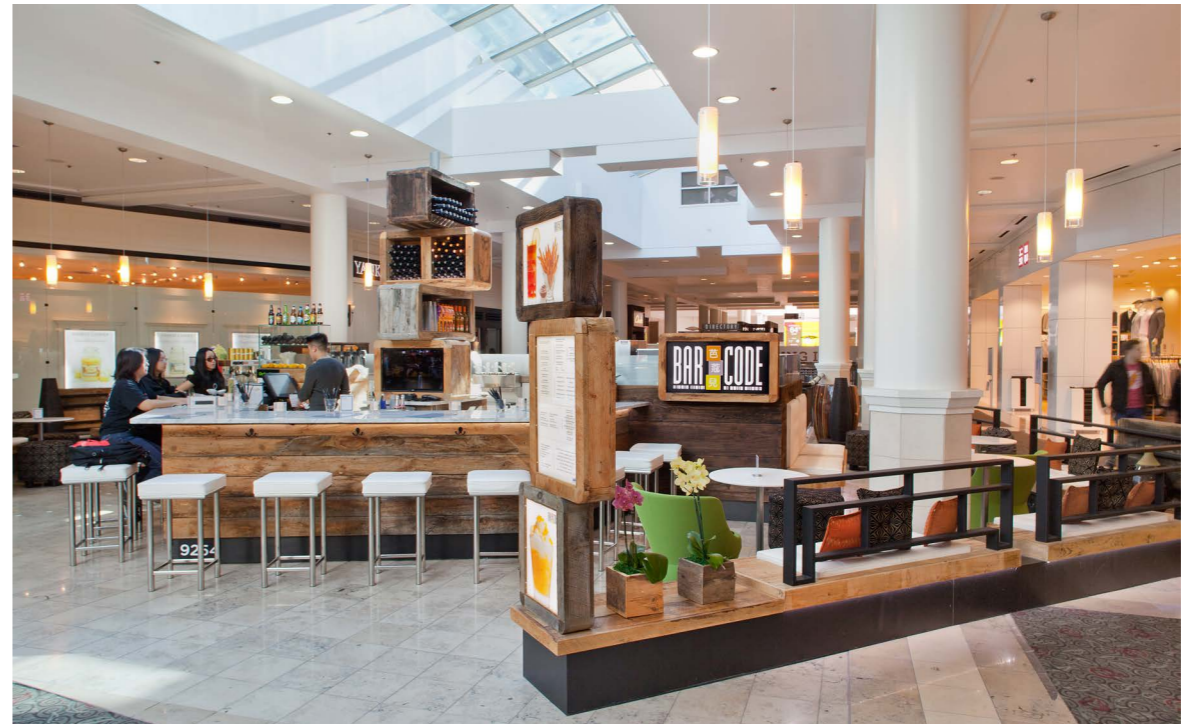

NATURAL, SOPHISTICATED, UNIQUE

> WHIMSICAL

WHIMSICAL



UNEXPECTED, PLAYFUL, COLORFUL

> INVITING

INVITING



WARM, CALM, OPEN, SOFT

> ARTSY

A R T S Y

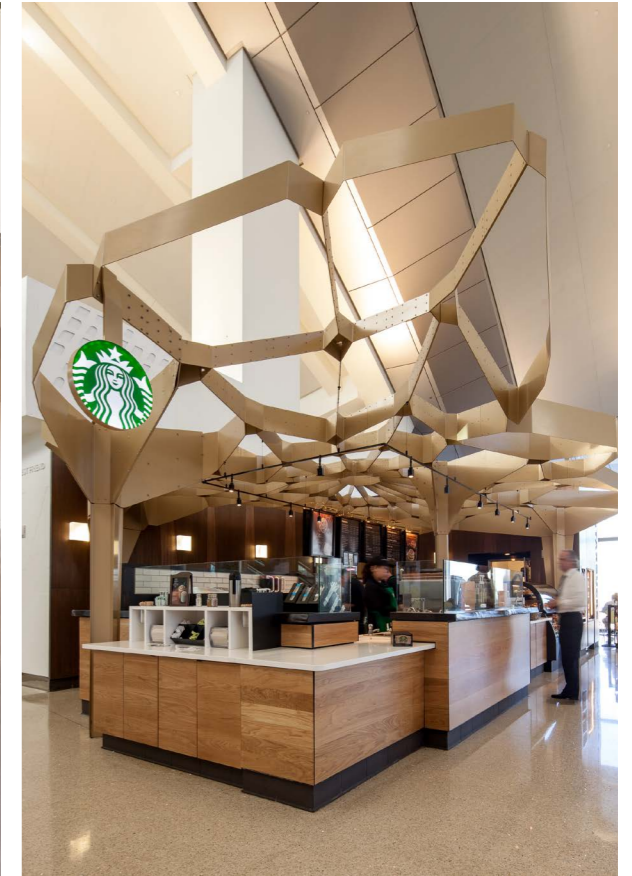

QUIRKY, AVANT GARDE, SURPRISING

> THEATRICAL

THEATRICAL

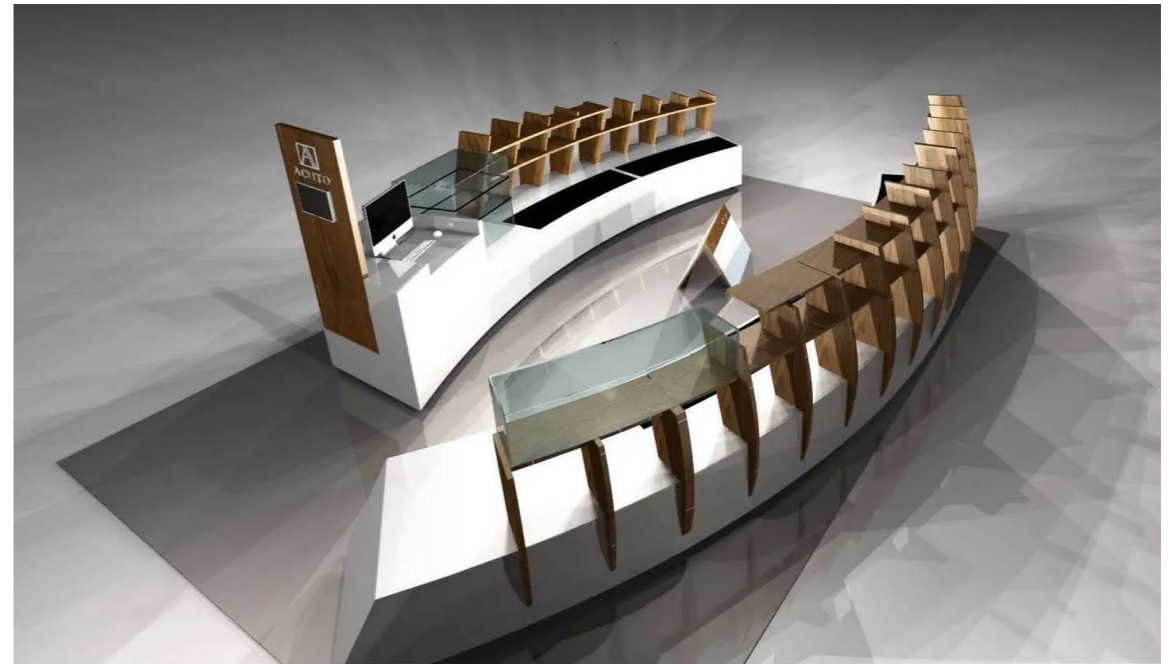

DRAMATIC, HIGH CONTRAST, VISUAL MOVEMENT,
MULTI-LEVEL DISPLAY

DESIGN ELEMENTS AND REQUIREMENTS > CONTENTS

- TRAFFIC FLOW
- QUEUING
- SEATING
- LAYERING ELEVATIONS
- VISUAL MERCHANDISING
- BRANDING
- TECHNOLOGY AND MEDIA
- MATERIALS AND FINISHES
- LIGHTING & ILLUMINATION
- ACCESS GATE
- GLASS SHROUD
- CAMERAS/GRAPHIC FRAMES
- FLOORING
- STORAGE
- TOE KICK
- PYLONS
- DIMENSIONS

WELCOME!

This section provides an overview of design elements to consider and requirements to follow when designing your kiosk.

The elements detailed in this section apply to both of the following:

- “Dry” kiosks for retail
- “Wet” kiosks that involve food preparation within the kiosk



> TRAFFIC FLOW

TRAFFIC FLOW

Taking into account the flow of mall traffic, an open layout can:

- Increase inventory capacity and visibility. The unit can be shopped from the inside and outside.
- Encourages interactive shopping.
- Lets the customer assess your product before they engage, decreasing your sales transition time.
- Creates a more sculptural design, drawing more attention to your product.

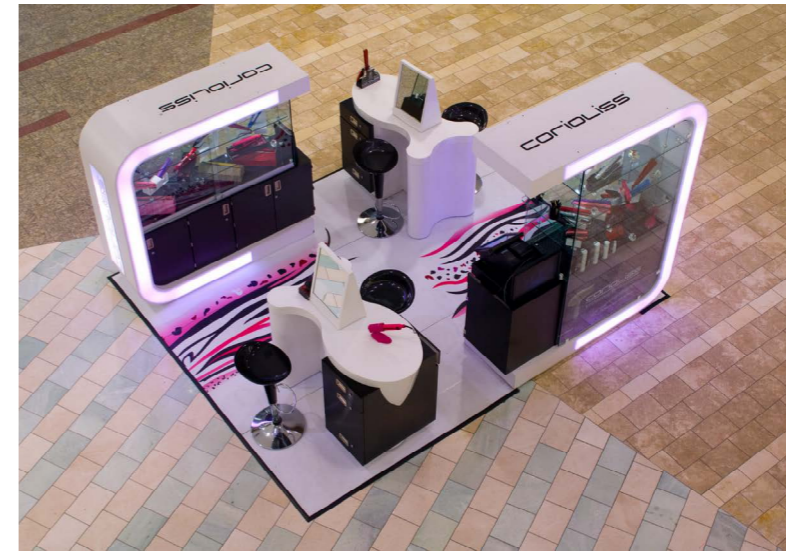
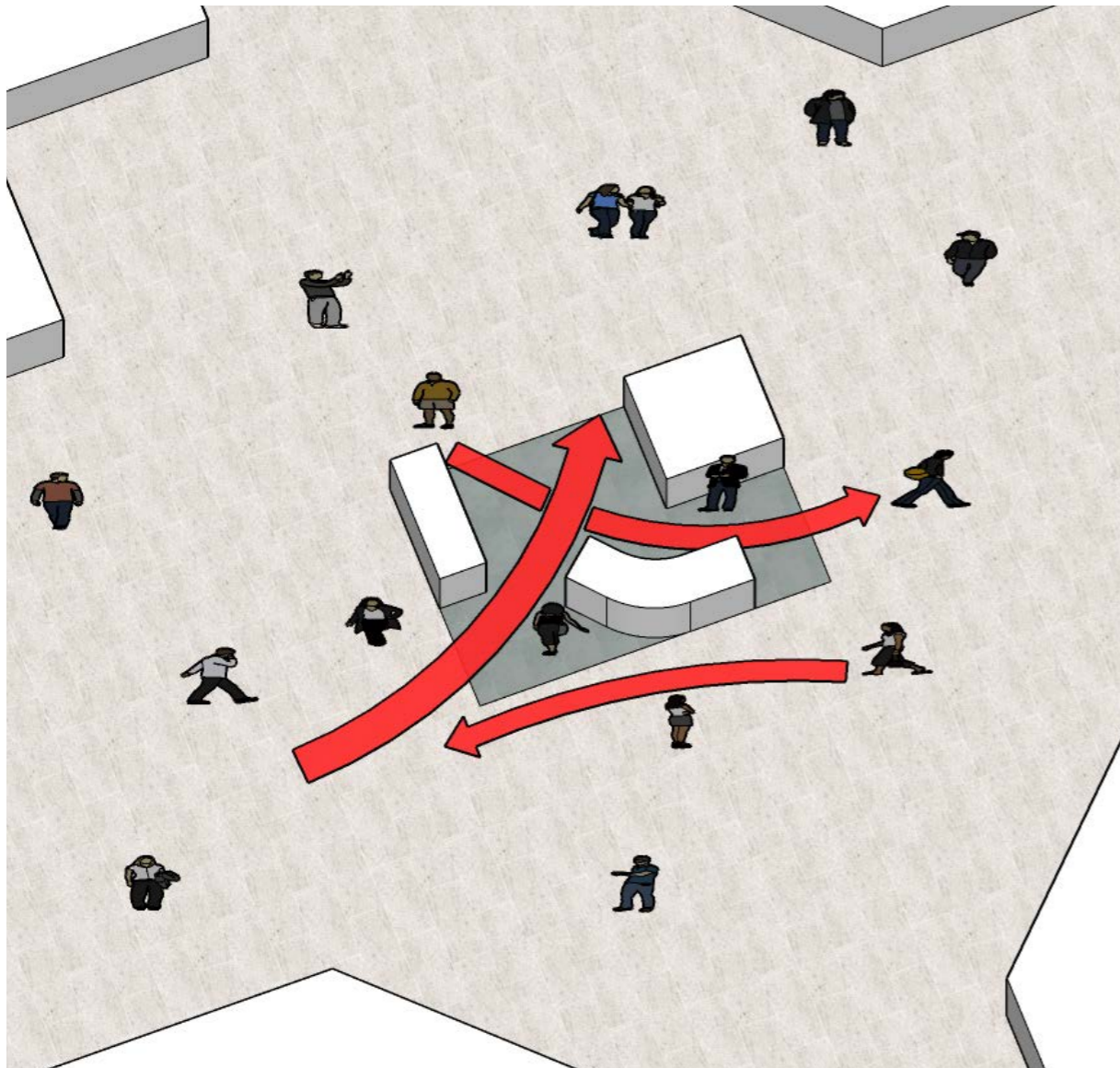

> QUEUING

QUEUING

It is important to consider the flow of Customer traffic as they line up to place an order. Be certain to make accommodations for queues of Customers in the space around your kiosk. The queue line should be directed so as not to obstruct flow of traffic in the mall.

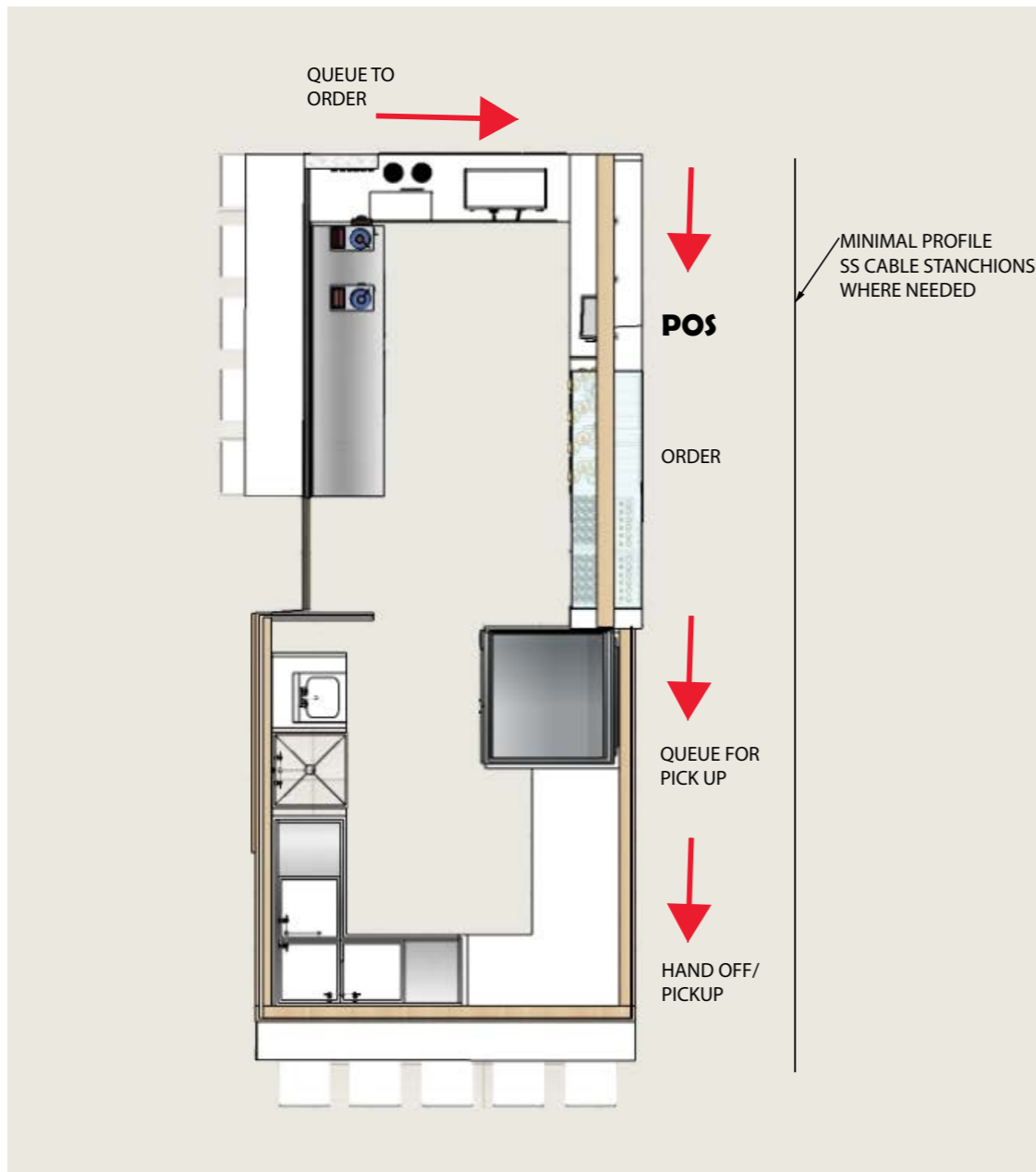

> SEATING

SEATING

Macerich's vision is to create food uses as "dwell" areas or destinations for the core Malls.

We encourage curves and angles to separate public spaces from back-of-house areas for the following reasons:

- Encourages areas for seating and dwelling.
- Creates transitional areas for shopping versus resting.
- Creates an interesting design, which in turn draws attention to your business.
- Curves, plants, and soft lines make an inviting and relaxing atmosphere to encourage dwell time.

Dedicated kiosk seating is also suggested, if appropriate for kiosk use.



> LAYERING ELEVATIONS

LAYERING ELEVATIONS

Walls and elevations can be used to make a canvas that communicates to your Customer.

An eye catching layered elevation may include:

- Walls with patterns and textures
- Overlays of materials
- Dimensionality (3D elements, features pulled forward/pushed back)
- Moulded shapes
- Overlaps to create shadows and depth
- Cove lighting for extra dimensions

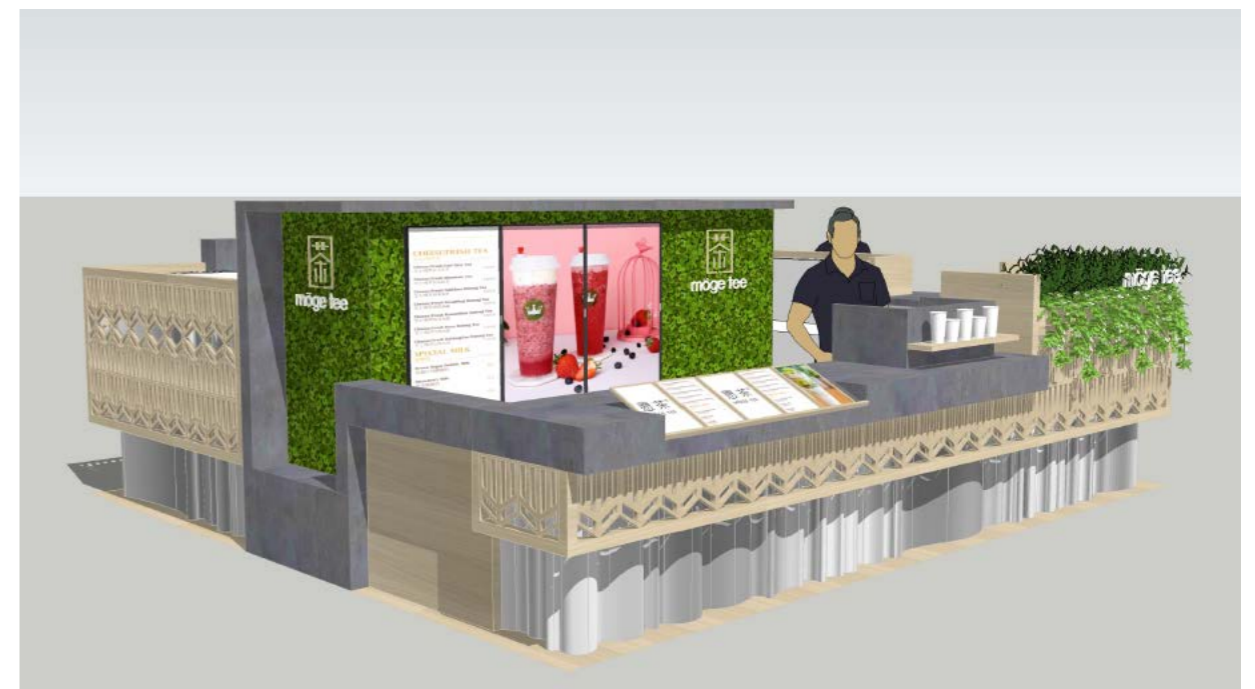

> VISUAL MERCHANDISING

VISUAL MERCHANDISING

Strong visual presentation and merchandising are essential and integral components of retail design.

- Always try to create a triangular composition within style groups or color groups. (display in groups of three or five).
- Start with a center feature (best sellers / hot items), and merchandise out symmetrically.
- Balance merchandise.
- Color block merchandise to create organized zones.

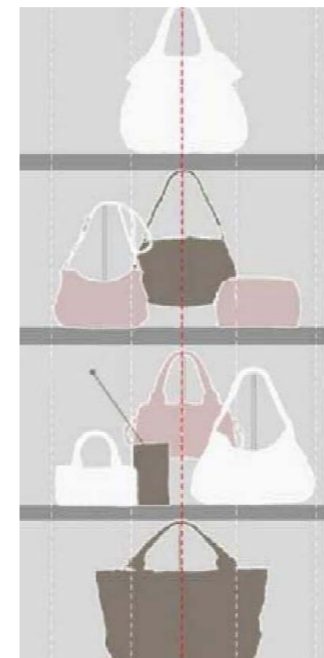

*SET YOUR STAGE,
SELL A STORY*

> BRANDING

BRANDING

A brand is a name, term, design, symbol, color, or some other feature that identifies a product or service as distinct from others.

Whether you have an established brand or are starting your first business, the kiosk team will work closely with you to enhance your brand look, so you fit with the Macerich experience.

Your branding can be communicated with signage, graphics, materials, shapes, colors, textures, patterns, and the overall look and feel of your kiosk.

Taglines are not permitted.

- Graphics must be mounted behind glass or acrylic and secured with stand offs¹.
- Handwritten signs are not permitted.
- All signage must be approved by the Landlord.

1 Stand off example shown below:



> TECHNOLOGY & MEDIA

TECHNOLOGY AND MEDIA

Technology can enhance your online operation by transforming your kiosk space into a multifunctional one, that lends itself to being an in-store pick up location, payment booth or advertising billboard.

Integrating technology into your kiosk can:

- Become an extension of you.
- Supplement your sales force with interactive screens for ordering, self-design functions, and more.
- Keep your business connected with your Customer.
- Help you tell a story.
- Help make menu boards easier to update and more clearly communicate via LCD screen loops.
- Digital/LCD menu boards must be in continuous use/display while the kiosk is in operation. Menu boards can be digital/LCD; all others must be static backlit graphics.
- Still images that are not menus must be backlit, and cannot be digital media/LCD screens.
- Digital screens that are not activated will be required to be removed.
- All moving graphics are not permitted.

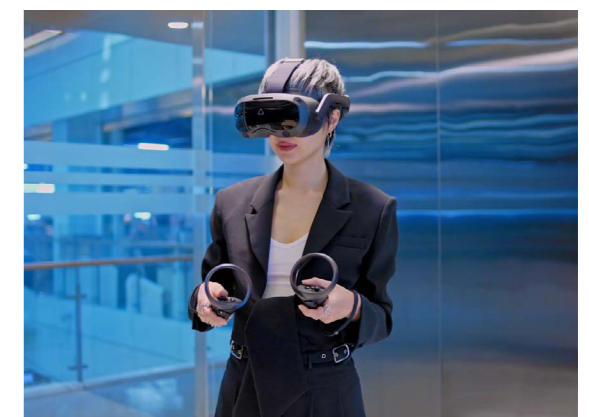
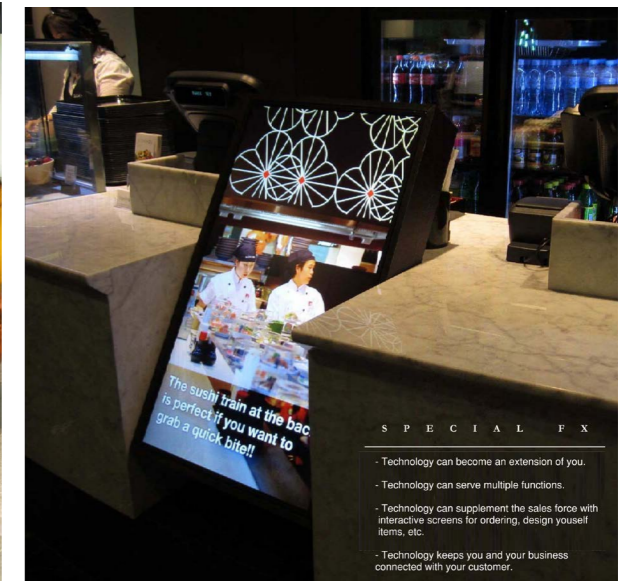

> MATERIALS & FINISHES

MATERIALS AND FINISHES

Kiosks experience heavy foot traffic and engagement. As such, kiosk materials and finishes must be durable and designed to withstand heavy wear and cleaning machinery.

- A material sample board must be submitted for Landlord approval before fabrication can begin.
- Building materials must be fire retardant, fire treated or non-flammable. Class A materials per building codes must be used.
- Selected materials must be authentic and natural such as woods, stones, reclaimed woods, mosaic tiles, etc.
- Plastic laminates are not permitted with the exception of color core or wood pattern high performance plastic laminates.
- Sample boards MUST include Tenant name and project location/Mall information

Material Sample Board example shown below. Sample materials are clearly labeled and secured to a sturdy backing board. Digital Material Sample boards may also be submitted.

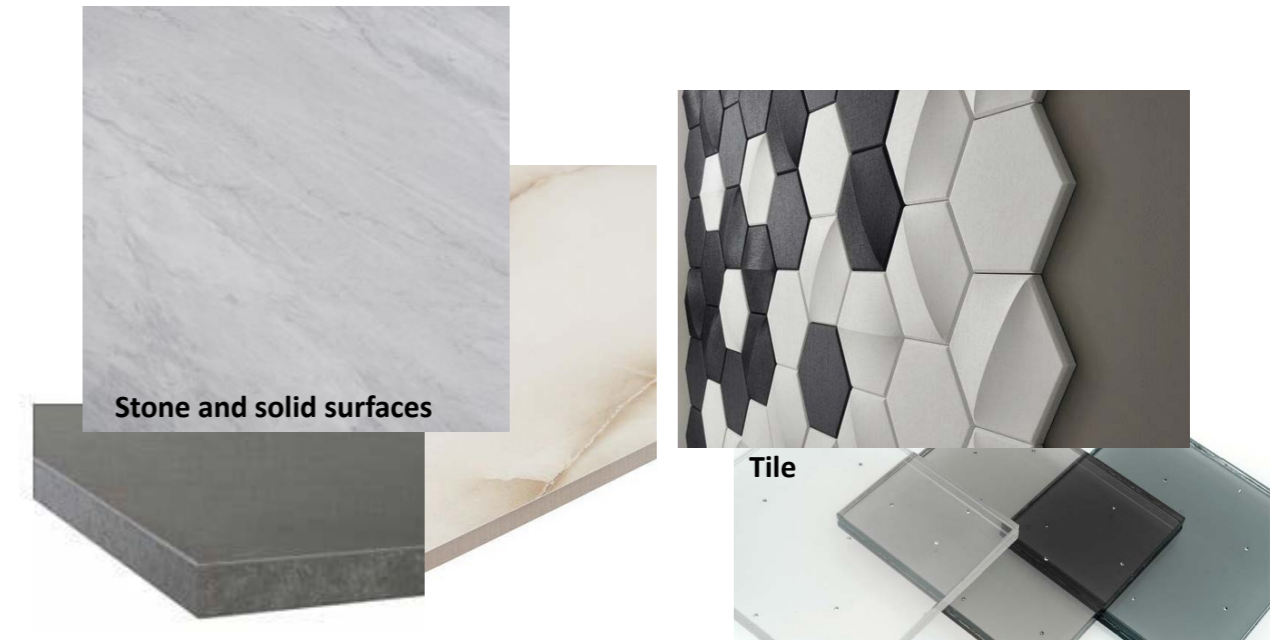

> LIGHTING & ILLUMINATION

LIGHTING AND ILLUMINATIONS

Lighting can be used to draw attention, create depth, and enhance the overall design of your kiosk.

- Light fixtures must be low profile and approved by the Landlord.
- Case lighting must be seamlessly integrated into the design.
- Ensure that the light source is concealed.
- If your kiosk is located under the ceiling, additional lighting elements may be considered but it must be connected to the Tenant's circuit.
- No track lighting or cable hung fixtures are allowed.
- No overhead canopies are allowed.
- All lighting must meet applicable building codes and safety requirements and will require Landlord approval prior to installation.



> FLOORING

FLOORING

Flooring is an important design element in an open kiosk layout for the following reasons:

- It is inviting and welcoming.
- It defines your footprint.
- Conduits can be run between cabinetry beneath the floor.

We encourage a wood flooring material like plank, for a warm look and feel.

Flooring requirements include:

- All flooring must be approved by Landlord prior to installation.
- It is a code requirement to comply with the ADA. (1" = 12" - transitional slope).
- Flooring must be laid over existing mall flooring. Mall flooring is not permitted to be removed.

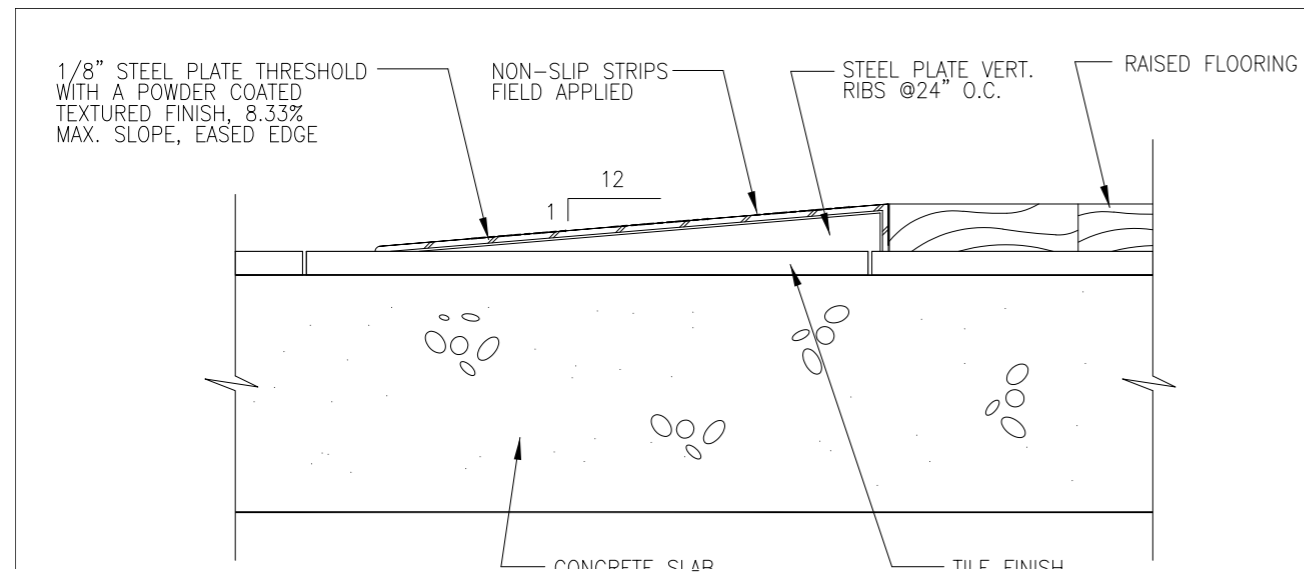
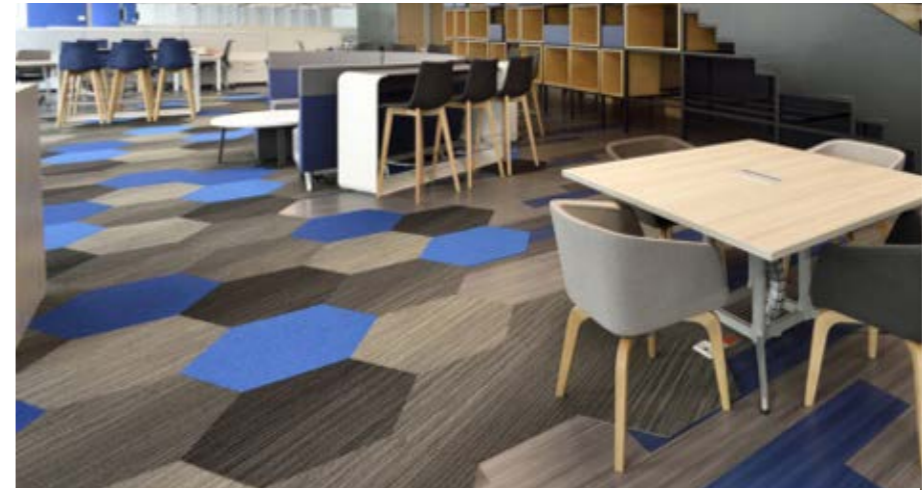

> ACCESS GATE

ACCESS GATE

A gate to enter a kiosk is a necessity. However it is not necessary for the customer to know where the gate is located.

- The gate must be seamlessly integrated into the overall design, to avoid being an eyesore.
- The gate shall be installed no more than 1" maximum above the finished floor.

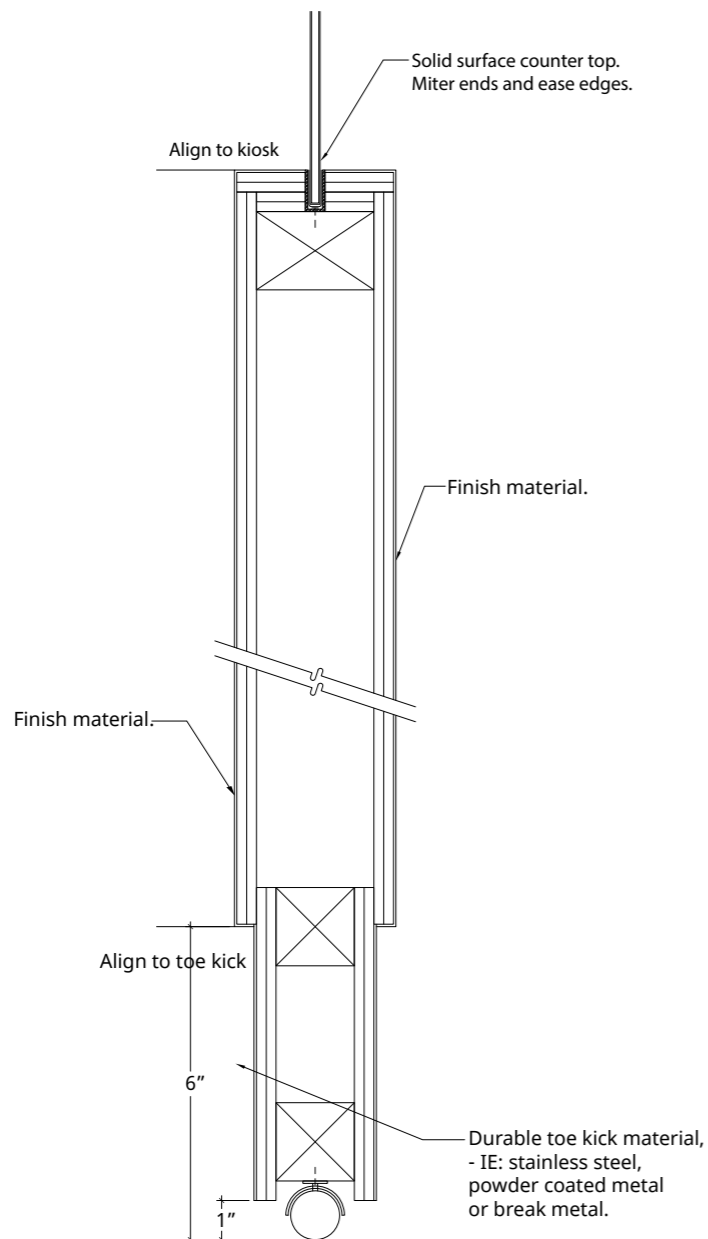

GATE DETAIL



> GLASS SHROUD

The following design details are required to be shown in your final design drawings. These details will help to ensure your kiosk is sturdy and built to last.

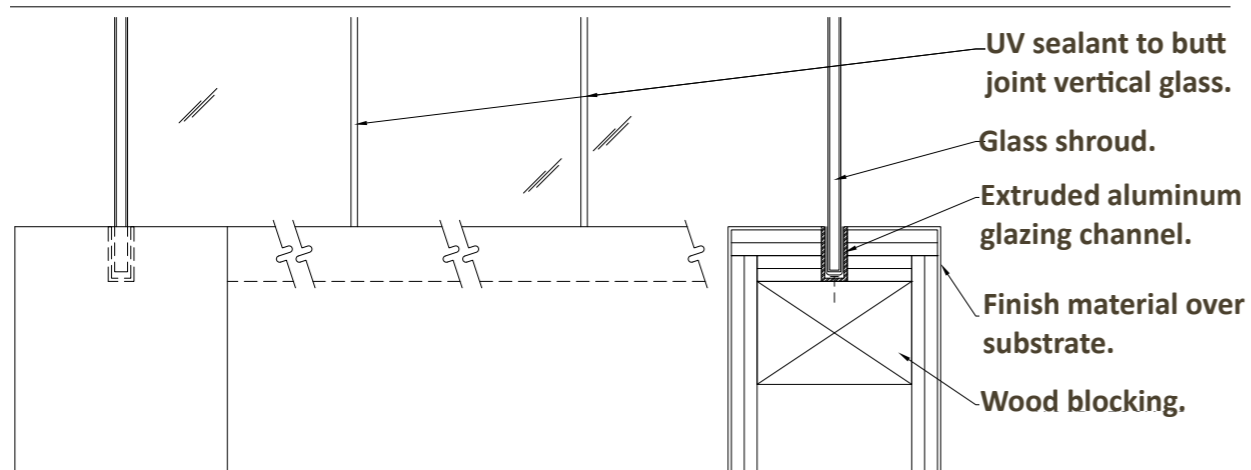

GLASS SHROUD DETAIL



Glass shrouds need to be frosted with an approved pattern.
Vertical SS posts between the shroud // glass panels are not allowed.
Equipment/supplies cannot extend past the glass shroud.



> CAMERAS/GRAPHIC FRAMES

If cameras are to be used, they must be discreetly integrated into the kiosk design, such as shown on the corner of the pylon sign in the image below. Camera cannot be surface mounted.

Camera details/specs must be included on submitted drawings for approval.



Note: For interchangeable frameless graphic panels, change graphic from back via concealed hinges and reveal details. (for back lit panels as well to replace lights). Use concealed / magnet activated locks to secure door.

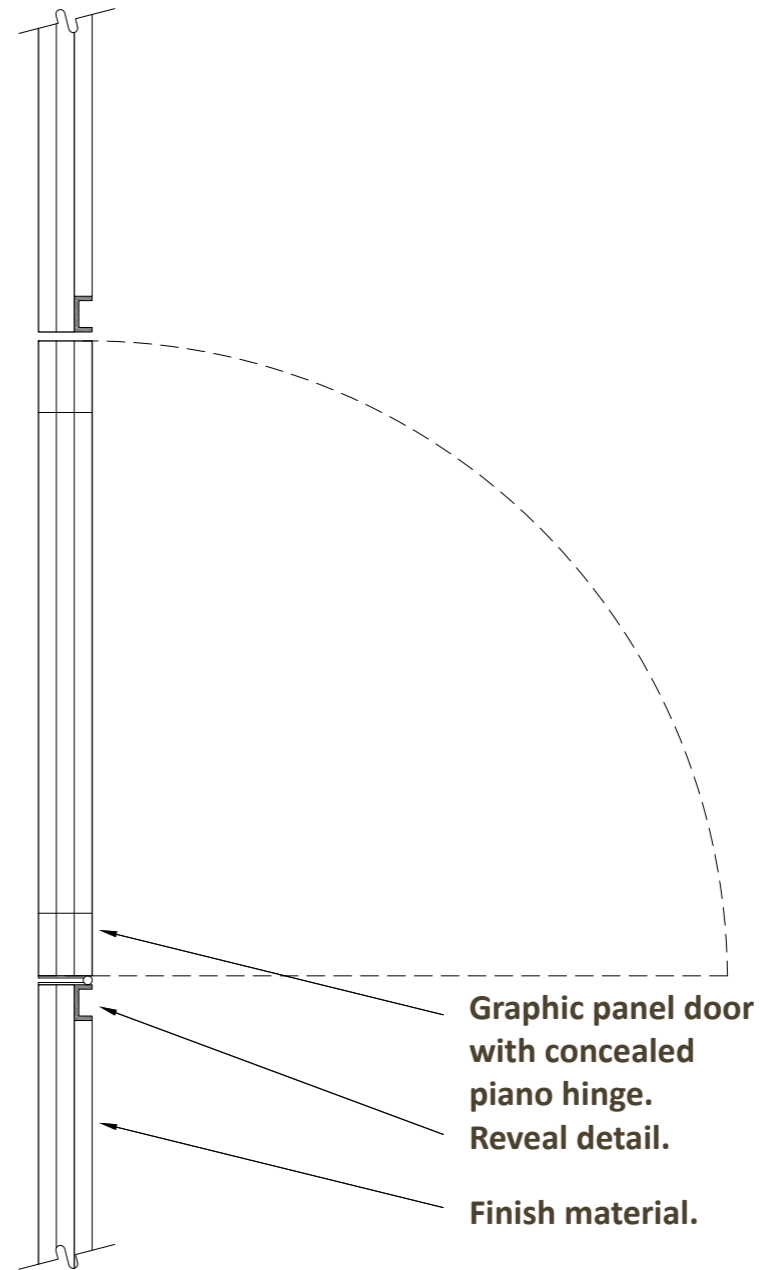

GRAPHIC FRAME DETAIL

> STORAGE

STORAGE

Maximizing sales volume naturally requires product storage within your kiosk. Storage should be integrated into your design to make it invisible to the customer.

- All interior storage must have doors or fixed fronts within the retail space.
- All cabinet hardware must be low profile, commercial grade stainless steel.
- Integrate all countertop displays into the design. No freestanding loose spinners or displays are permitted.
- All front counter service equipment must be shrouded to conceal cables or loose items from public view.
- Bins and brochure holders must be integrated into the overall design.
- Merchandise must be placed in shelving that is designed in line with the kiosk's overall look and feel.
- Equipment, cords, cables, and loose items are required to be hidden from the public view. Your kiosk design should include shrouding around POS and other counter equipment.

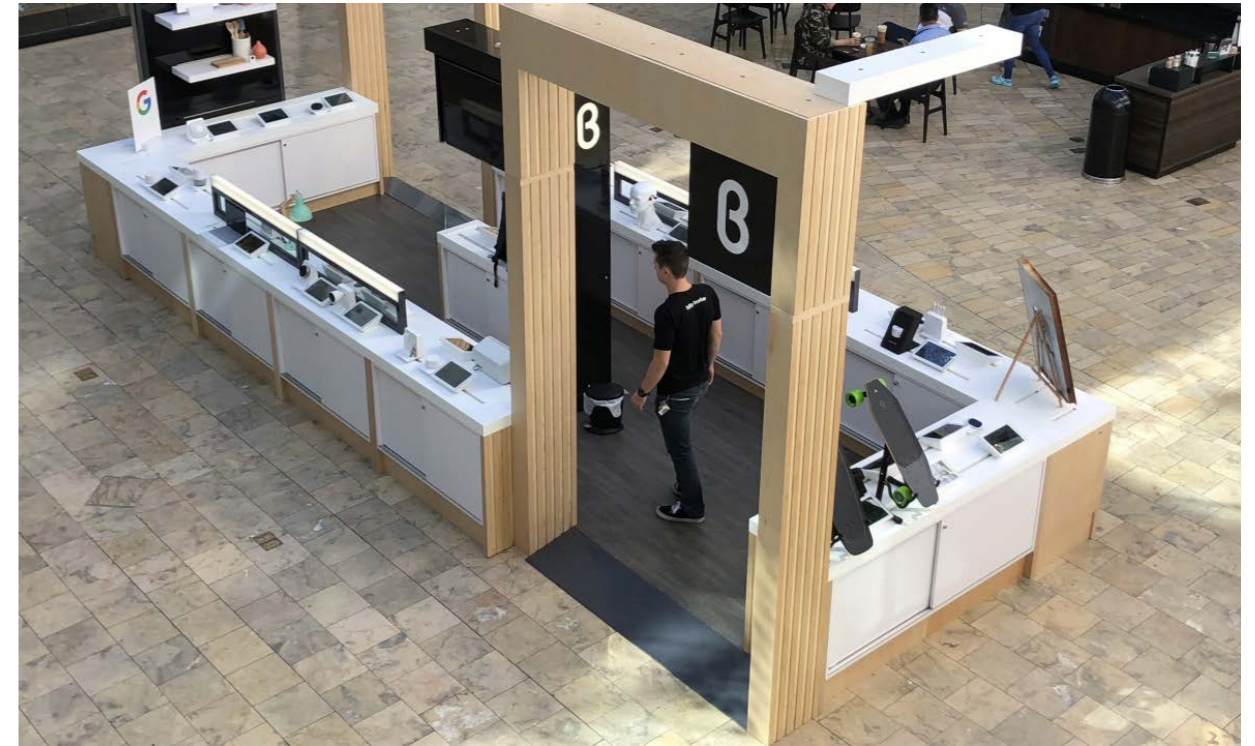

> TOE KICK AND CORNER DETAILS

TOE KICK

Toe kicks are important as they minimize damage to your kiosk from foot traffic and cleaning machinery.

- Kick material must be durable.
- Kick should be 4-6" high and 3" inset.
- An 1/8" metal extrusion at the toe kick is required to protect kiosk finishes from foot

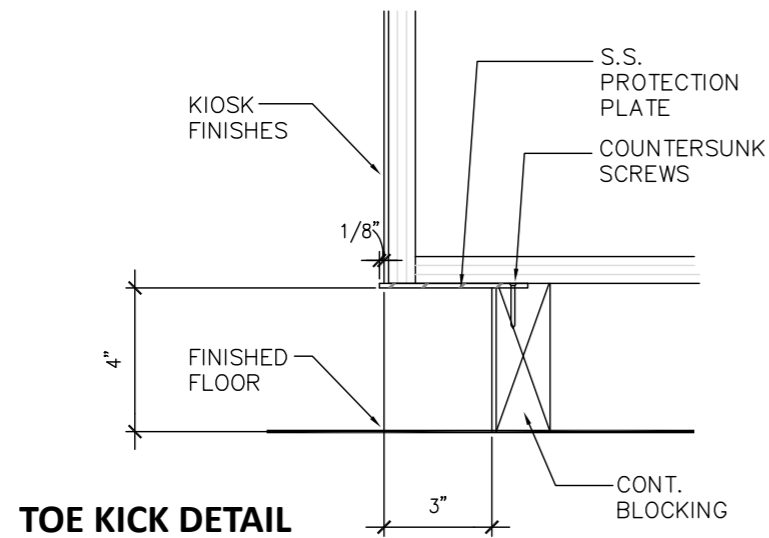

Note: Can be used for vertical corner only.

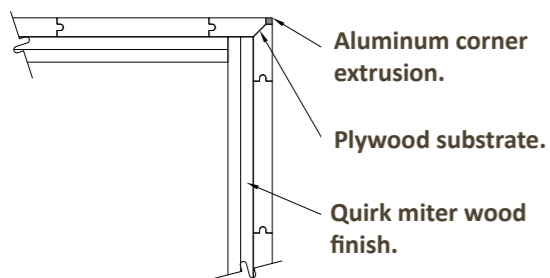

CORNER DETAIL

Note: Can be used for vertical corner only.

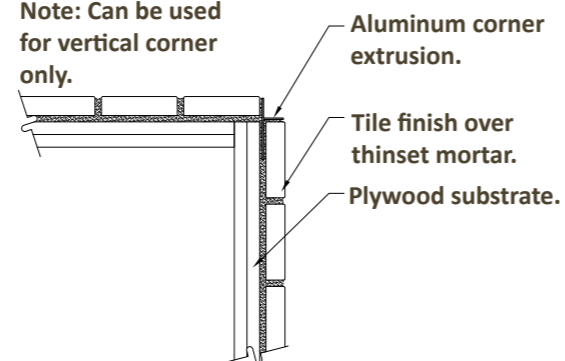

CORNER DETAIL



> PYLON SIGN EXAMPLES



> PYLONS

traffic and cleaning machines.

PYLONS

We encourage that your design incorporate a pylon shape that enhances your brand experience and communicates what you are offering.

If your lease line includes a column, you have a unique opportunity to brand it with additional signage and accent lighting.

- Design must be integrated and coherent with the retail design.
- Max allowable size is 7' tall by 3' wide and 6" deep.
- Secondary pylons are encouraged at a maximum size of 4' tall by 3' wide. Any and all pylon signs under 7' tall must have a 30-degree angled surface at the top of the sign. Food use kiosks do not need angled surfaces at the top of secondary pylon signs.
- Freestanding neon or neon lit signs are not permitted.
- All signage must be approved by the Landlord prior to installation.
- **Any cameras must be discreetly recessed into the pylon sign, and must use a minimal profile camera. Any and all camera placements must be approved by the Landlord prior to installation. If cameras are to be used, they must be included in the CD set for review and approval.**

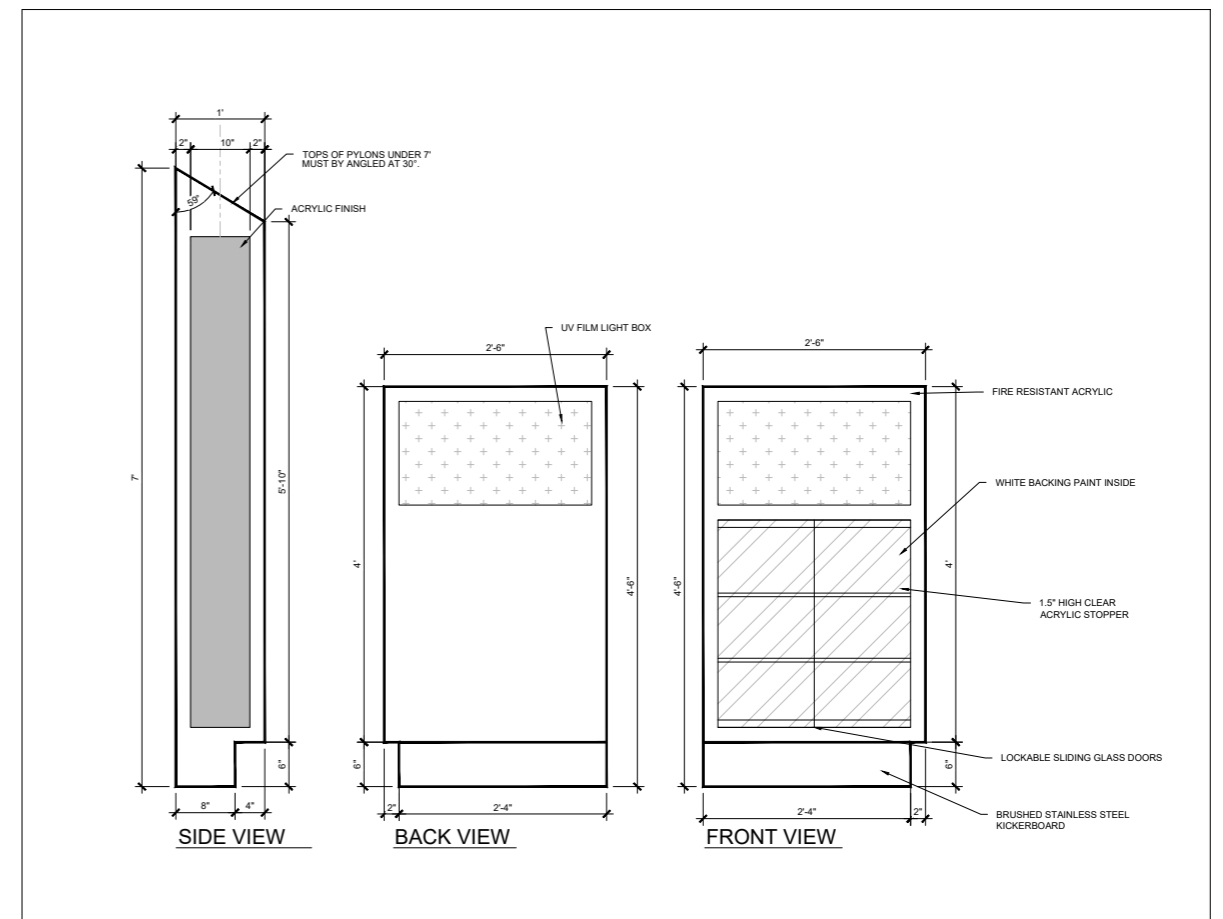

> DIMENSIONS

DIMENSIONS

We want your kiosk to stand out and attract customers through excellent design. With that in mind, it is also important to keep common area sight lines open. To achieve this, we have a few dimensional requirements to follow:

- A maximum height for opaque walls is 4'-0", with a 1'-0" translucent glass shroud up to a 5'-0" total height, where required by the Health Department.
- KIOSK ENVELOPE height (excluding pylon signs) shall not exceed 5'-0" tall.

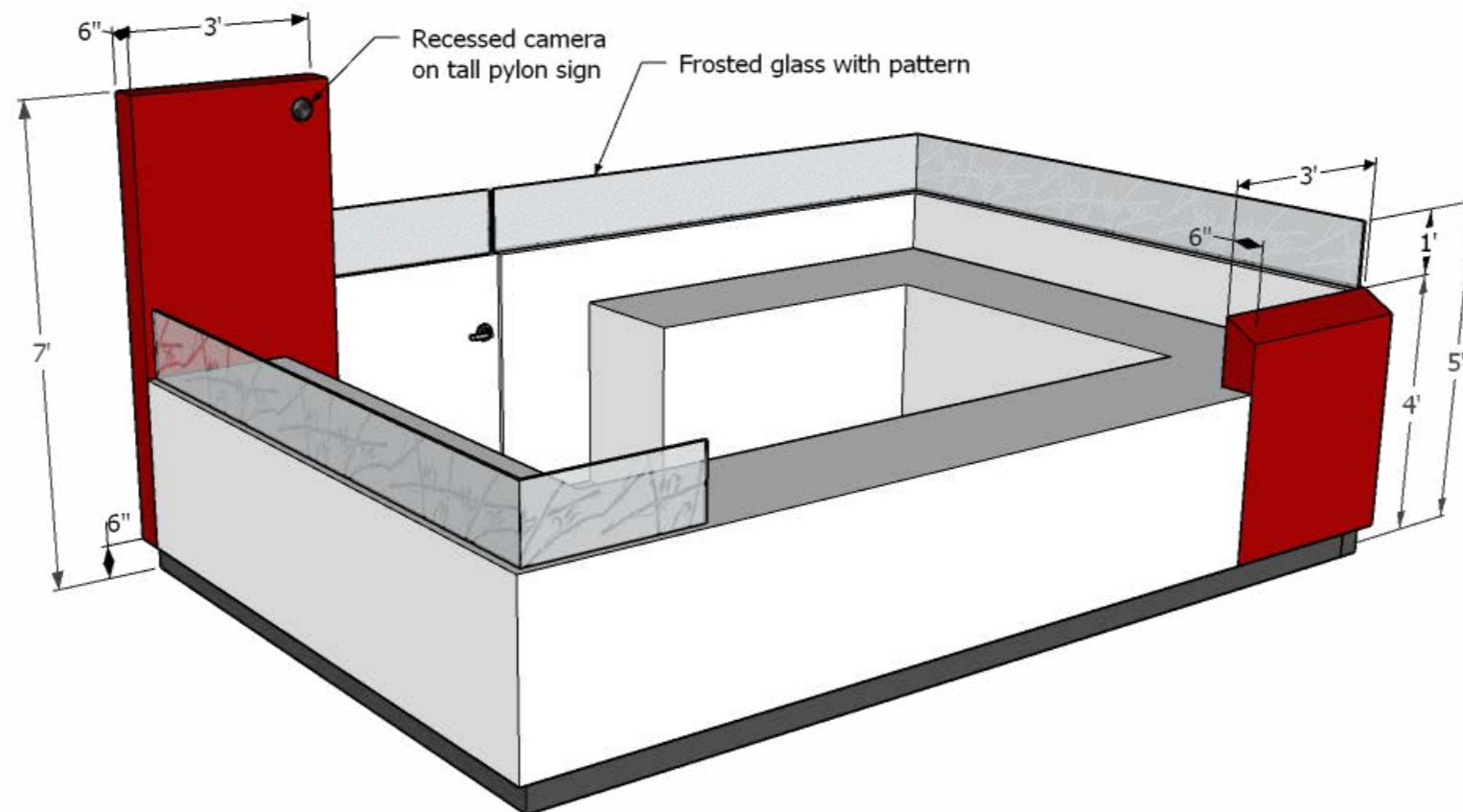

Generic Kiosk Example

FOOD DESIGN ELEMENTS AND REQUIREMENTS > CONTENTS

- ❑ FOOD DISPLAY
- ❑ FOOD PREPARATION AREA
- ❑ MENU BOARDS
- ❑ CONDIMENTS AND UTENSILS

A FEAST FOR YOUR EYES!

This section provides an overview of the specific design elements and requirements to consider for a “wet” food producing kiosk. It is important to embrace the cooking and display of food as an integral design element to your kiosk. Food is a great tool to entice the consumer.



> FOOD DISPLAY

FOOD DISPLAY PRESENTATION

We encourage you to incorporate food display of your goods to showcase your brand to Customers. Presenting freshly made options from the menu will entice the eyes of your customer and provide an instant way to purchase an item. Labeling your items helps identify your offerings.

- Food displays must be appetizing and behind clean and clear glass.
- Labels should accent the design of your kiosk.
- Signage should be professionally printed on card stock and utilize proper display methods.



DISPLAY THE GOODS IN AN APPETIZING MANNER.



> FOOD PREPARATION AREA

FOOD PREPARATION AREA

Visual food preparation is an added value to your brand experience, resulting in excitement and interaction for the Customer.

- Obstructive overhead canopies are not permitted. An alternative solution to an overhead canopy should be used if one is required by the Health Department.
- Check local building codes for requirements on plumbing venting inside a wall or if it occurs on the exterior wall.
- If the preparation of your product(s) emits odor, especially through the use of equipment (such as self-contained fryers, ovens, etc.), all odors must be contained within the kiosk footprint. Tenants must enclose all odor within their premises.

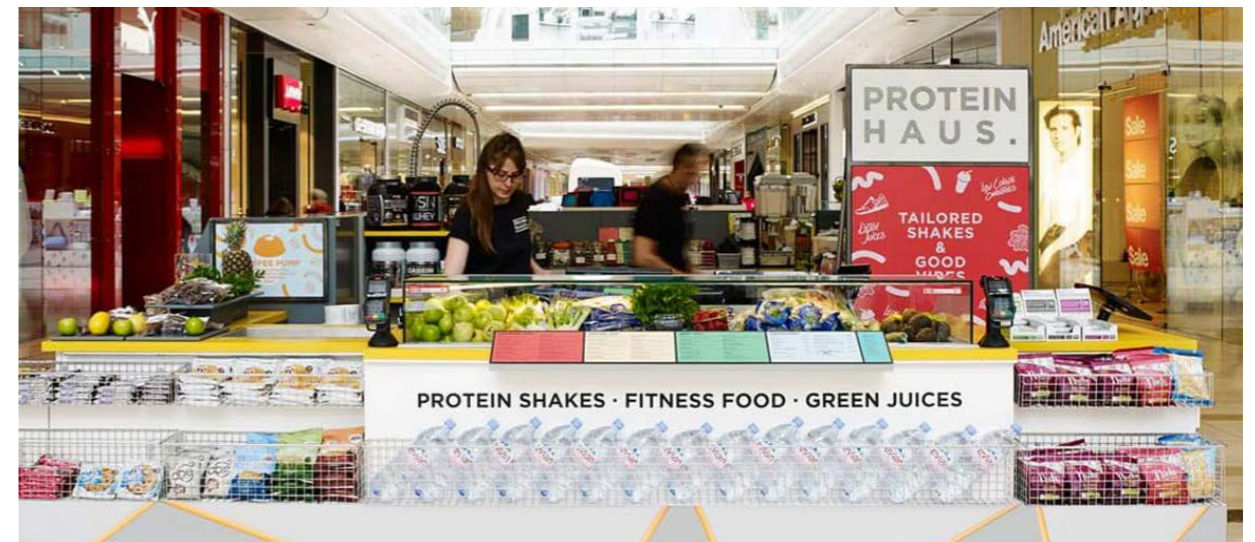

> MENU BOARD

MENU BOARD

Your menu board is a vital brand element to communicate your product to the Customer.

- Design must be integrated and coherent with the retail design.
- Loose and/or taped up menus are not permitted.
- The top of the menu board may not exceed a height of 5'. The only exception is when the menu board is located on a pylon.
- Digital/LCD menu boards must be in continuous use/display while the kiosk is in operation.

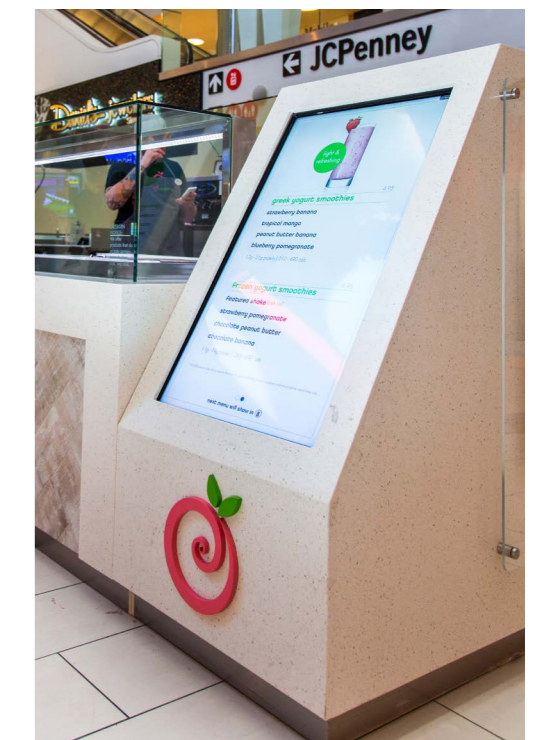

> CONDIMENTS & UTENSILS

CONDIMENTS AND UTENSILS

Condiments, utensils, napkin holders, etc., can be an eyesore if not properly accounted for in the kiosk design.

- Items must be integrated seamlessly into the overall kiosk design.
- Loose items on the countertops are not permitted.

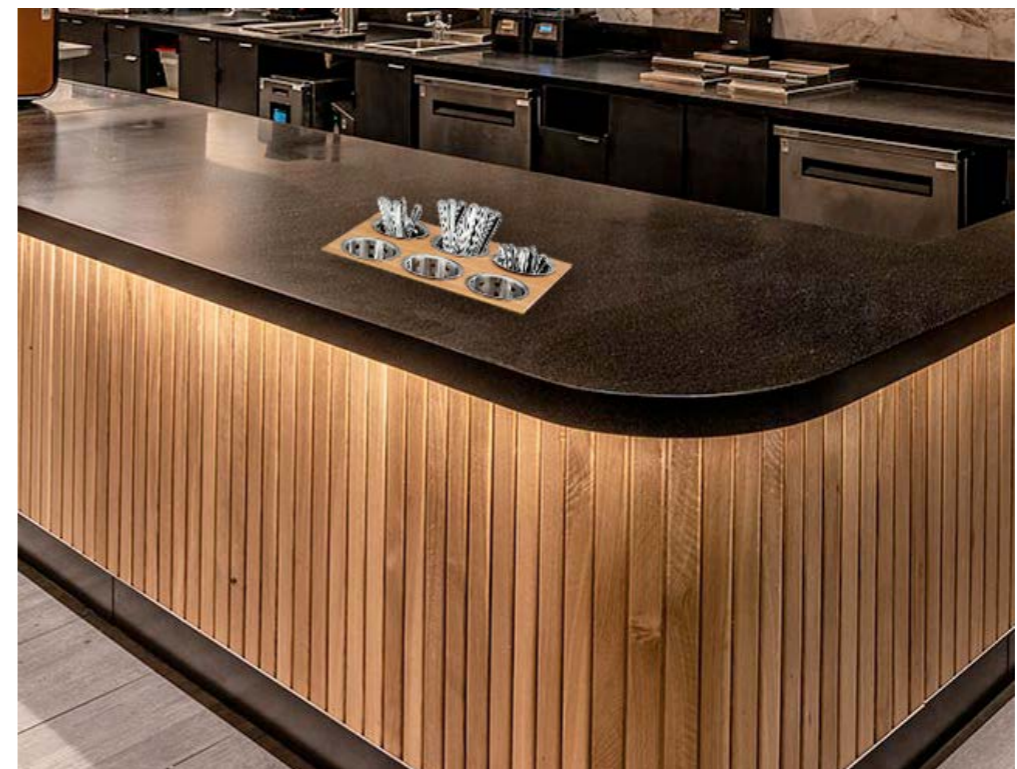
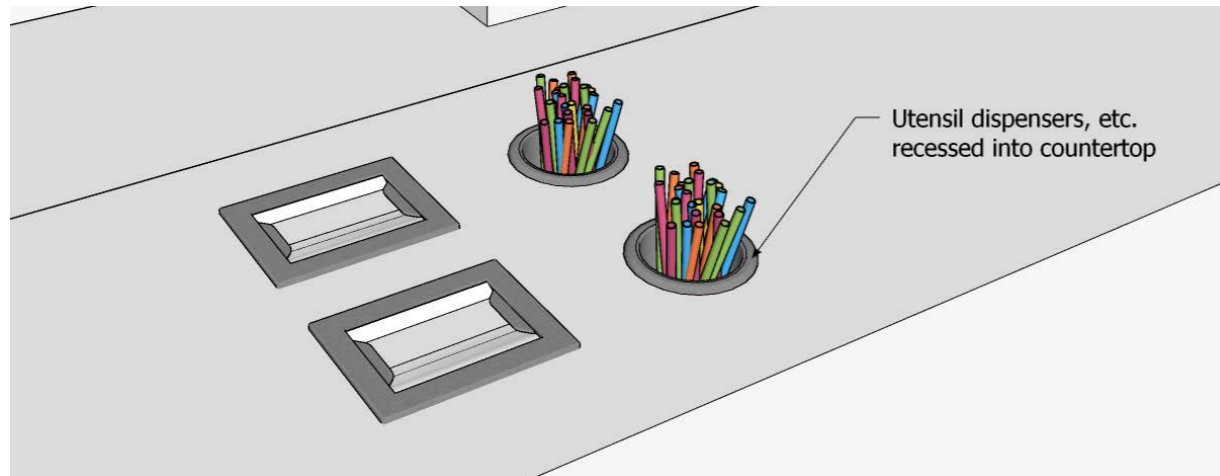

> ELECTRIC / DATA / PLUMBING / STORAGE

OVERVIEW

The Technical Criteria is designed to provide building details and design requirements for the Property's technical systems.

It is the Tenant's responsibility to verify existing conditions and comply with all applicable codes and standards for all technical systems.

Tenants are required to adhere to the full Criteria during their design and construction.

ELECTRIC

Most retail kiosk spaces are typically provided 20 amps of low voltage power stubbed into a J-Box under the floor. In certain kiosk locations, more power exists. It is the responsibility of the Tenant to field verify the amount of existing power in their Premises, to ensure it suits the Tenant's needs, prior to signing the Lease.

Tenant kiosk installations are typically required to tap into the provided power, and distribute inside their kiosk. The following requirements must be met:

- **IDENTIFY** all Tenant equipment in the Mall electric room with clear labels that include the Tenant name and space number.
- **CUTTING AND PATCHING** must be provided by Tenant.
- **MATERIAL AND EQUIPMENT** must be new and of a commercial grade with UL Labels and where such labeling applies.
- **WATERTIGHT FLOOR BOXES** are required.
- **EXPOSED WIRING** is not permitted. All wiring of any type must be installed in conduit or must be metal clad cable (MC). Metal clad cable will only be allowed for concealed branch circuit wiring within the demised premises. Flexible conduits must be used for connections to vibrating equipment.
- **EXPOSED LOW VOLTAGE** wiring must be plenum graded.

DATA AND COMMUNICATIONS

Kiosk spaces are typically provided an empty conduit with a pull string stubbed into a J-Box under the floor.

- **DATA SETUP AND SERVICE INSTALLATION** is the Tenant's responsibility to coordinate direct through Granite Grid. Other data providers are not permitted at this property as they do not have an access agreement in place.
- **TELEPHONE DEMARC WORK** must be performed by Landlord's approved telephone subcontractor, Granite Grid.
- **TELEPHONE SERVICE** is the Tenant responsibility to coordinate directly through Granite Grid and install within their premises.

PLUMBING

Kiosk spaces may or may not have existing wet utilities. It is the responsibility of the Tenant to field verify the wet utilities in their Premises, to ensure it suits the Tenant's needs, prior to signing the Lease.

Tenant kiosk installations are typically required to core into the floor, tap into the provided plumbing, and distribute inside their kiosk. The following requirements must be met:

- **GARBAGE DISPOSALS** are not allowed.
- **HAIR RECEPTORS** must be installed on all sinks, basins, and special sanitary units which may in any way receive human or animal hair.
- **GREASE INTERCEPTORS** must be installed within the kiosk footprint.
- **KITCHEN SINKS** including pot sinks, scullery sinks, pre-wash sinks and other kitchen units must be connected to a grease trap as per code.
- **DISHWASHERS** may not be connected to grease trap.
- **OIL COLLECTION AND HAULING SYSTEM** is required for Tenants with fryers or other grease/oil generating equipment that does not run through an interceptor. Landlord does not provide a centralized collection point.
- **FLOOR PENETRATIONS AND PLUMBING** by Tenants must be coordinated with the Landlord.

PROCESS > DESIGN KICKOFF / DESIGN SUBMISSION / PERMITTING & CONSTRUCTION

This section provides a brief overview of the design, permit, and installation process steps to get your kiosk open.

DESIGN KICKOFF

We want to help you create an incredible kiosk to maximize your brand’s potential. Your Tenant Coordinator will contact your team to schedule a design kickoff call. The purpose of this call is to collaborate on your design intent and help you understand the requirements in this Criteria.

DESIGN SUBMISSION AND REVIEW

Requirements on how and what to submit for the Landlord drawing review of your kiosk can be found in the [SUBMITTALS CRITERIA](#).

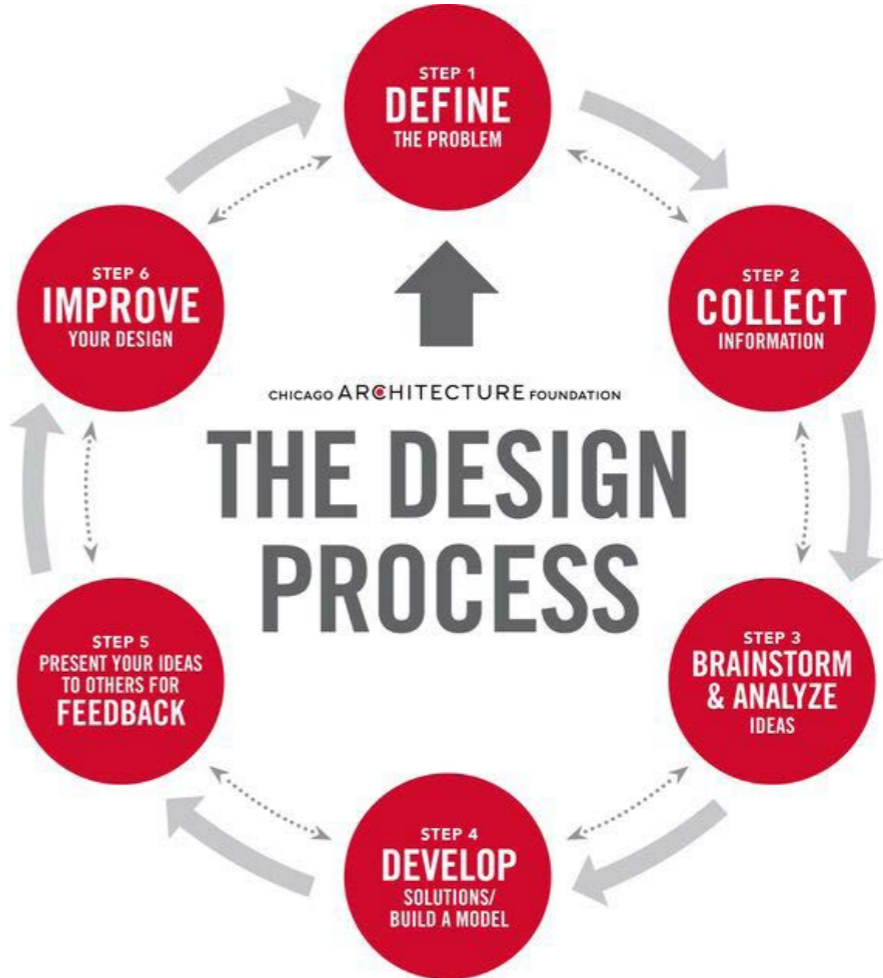

SUBMITTAL CRITERIA CONTENT OVERVIEW

2.1

CONSTRUCTION DRAWINGS

SUBMITTAL REQUIREMENTS FOR ARCHITECTURAL AND TECHNICAL DESIGN DOCUMENTS.

The Submittals Criteria highlights the Landlord review process and drawing submittal requirements to ensure a quick and smooth drawing review for your design and construction drawings.

Tenant construction and signage drawings must be reviewed and Approved by the Landlord before the drawings can be submitted for permit. Permits from the local Municipality are required for all incoming Tenant construction and signage.

It is always the Tenant's responsibility to ensure:

- Compliance with the Lease document.
- Field verification of conditions and dimensions.
- Discrepancies between the drawings and the as-build conditions.
- Coordination with trades to ensure compliance with all local and national codes.

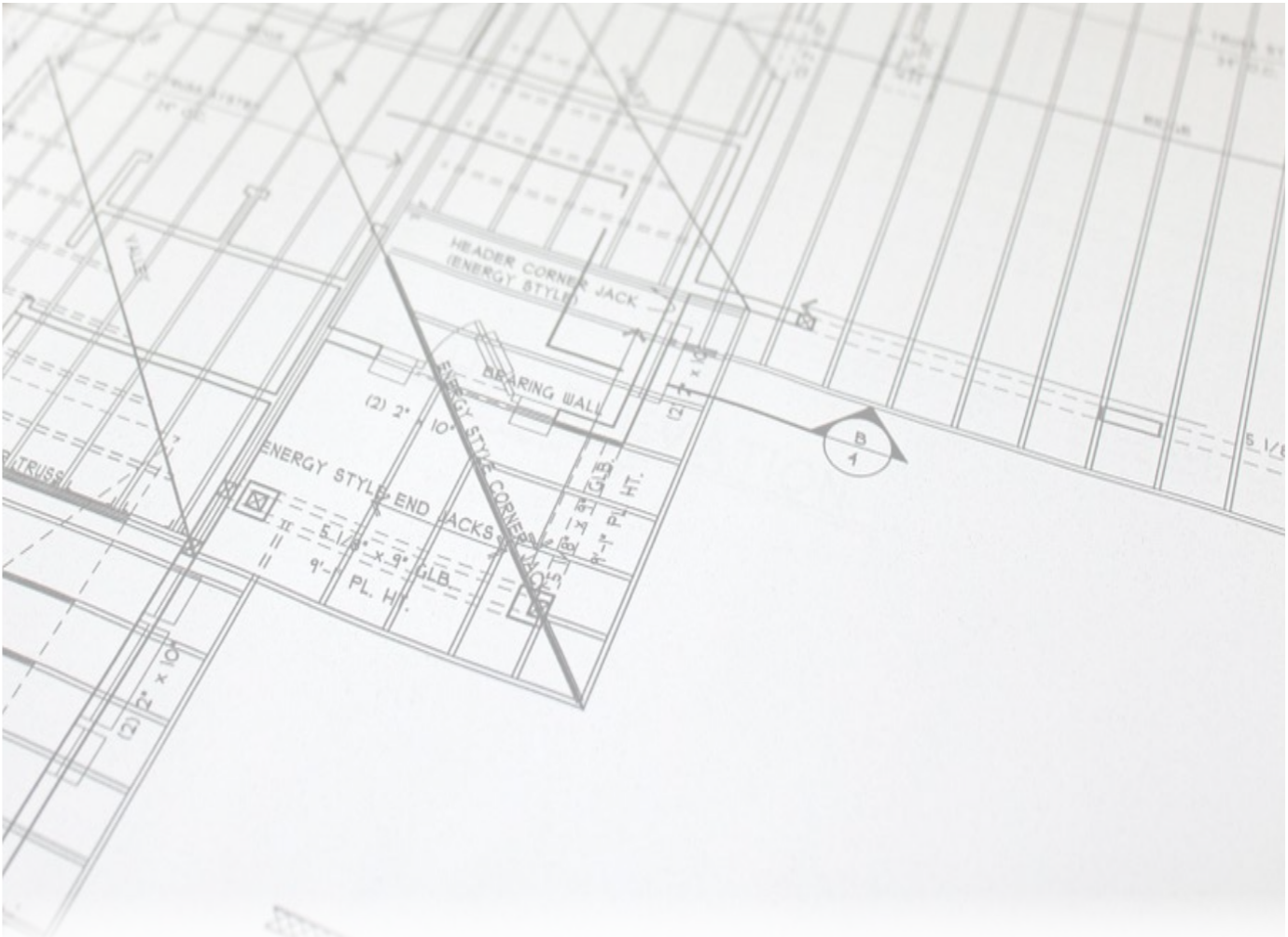

KIOSK DRAWINGS > PROCESS & TIMELINE

DRAWING REVIEW PROCESS

Drawing reviews are required to be submitted in two stages for Landlord review; Preliminary and final Construction Drawings. Preliminary drawings are required to ensure the design process moves quickly by ensuring that all Criteria requirements are understood and adopted early in the design. This helps ensure an expedited review of the final Construction Drawings.

REVIEW TIMELINE

Step	Action	Time Period
1	Tenant submits preliminary design.	Required 20 days after Lease Execution or 10 days following previous submittal disapproval.
2	Landlord Approved Preliminary Design.	15 days after confirmed completion of Step #1.
3	Tenant submits final construction drawings.	Required 20 days after Tenant Coordinator approval at Step #2.
4	Landlord Approves final documents.	15 days after completion of Step #3.
5	Tenant submits drawings for permit.	5 days after confirmed completion of Step #4.

> SUBMITTAL REQUIREMENTS > PRELIMINARY, FINAL

PRELIMINARY DESIGN SUBMITTAL

The Preliminary Document review process will evaluate all the criteria discussed in this manual, including overall three-dimensional form, degree of design uniqueness and identity, use and detailing of materials, colors and lighting, and integration of signage and graphics.

Submittals are to provide the reviewer with a clear understanding of proposed design concepts.

The submission must be complete in order to fairly evaluate the proposal and prevent continuation of work on an unacceptable design.

Tenant shall submit to Landlord at tcphoenix@macerich.com an electronic PDF file of the following:

- **Color and Material Sample Board**
Include actual samples of all Tenant colors and materials visible to the public, on a digital sample board. Clearly label all materials and reference to floor plan elevations.
- **Perspective and/or Photo Image(s)**
Colored perspective rendering and/or prototypical photo images of the proposed storefront, including graphics and signage.
- **Cover Sheet**
Include: Name of Tenant, name of Mall or Center, space number, Applicable Codes, Building Type and Occupancy Type, Leased square footage, and Key Plan.
- **Floor Plan**
¼" Scale Minimum showing: Entire lease dimensioned space with room names, floor finishes, casework and fixture locations.
- **Reflected Ceiling Plan**
¼" Scale Minimum showing: Lighting design, including fixture types and locations, signage, access panels, Overhead projections such as light coves and fascia systems, and Entrance.
- **Sections**
1" Scale Minimum showing: Entry, Display windows and fascia, Sign integration into storefront design.
- **Storefront Elevations**
½ Scale Minimum showing: Exterior views - front and sides, Signs, graphics, logos.

A physical sample board may be required, in cases involving unique or unusual materials. Physical sample board shall be mounted on foam core or card stock to be sent in coordination with your Tenant Coordinator. Materials to be clearly labeled, and board must include tenant name and name of center/mall where project is located.

ADDENDUM LINKS

This Addendum contains links to supplemental documents of specific requirements and information. These documents are considered part of the Tenant Criteria Package. Clicking the links below will navigate to the described documents. It is the responsibility of the Tenant, its contractors, subcontractors, architects, engineers, employees, and agents to comply with terms of the Tenant Criteria, Addendum included.

GLOSSARY

- [GLOSSARY OF TERMS](#)
Defines commonly used terms for clarity.

DESIGN ADDENDUM

- [MACERICH SUSTAINABILITY HANDBOOK](#)
Guide to encourage energy efficient, sustainable design.

BARRICADE ADDENDUM

- [BARRICADE GUIDELINES](#)
Guide to installing and activating construction barricades with graphics.

SIGNAGE ADDENDUM

- [DIGITAL SIGN CRITERIA](#)
Design requirements for Tenant's digital signage.

CONSTRUCTION ADDENDUM

- [PUNCH LIST](#)
Reference Landlord Punchlist that that Landlord will use to inspect and confirm completion of Tenant construction.