



BROADWAY PLAZA

# TENANT CRITERIA

MACERICH®

# VISION STATEMENT

## Welcome to Broadway Plaza.

It is our vision and mission at Macerich to distinguish ourselves through superior performance in retail development and continuous improvement of our portfolio, to meet the changing needs of our customers and the retailers we serve. Our commitment is to furnish a well-designed, well-maintained and well-marketed retail environment, capable of maximizing traffic and sales.

We are pleased to become partners with retailers, striving for the same goals. We are ready to facilitate communication and share our expertise with you to complete your store within expected timelines.

These criteria act as a guide for the design of all work by Tenants in conjunction with the provisions of the Tenant's lease with the Landlord. Tenants are encouraged to express their own unique design statement within the parameters of the design criteria as outlined in this manual.

National and regional "standard" storefront concepts are respected to the extent that they meet the design criteria. However, tenants should be aware that some concept modifications might be necessary to comply with the Center's criteria.

The same is true for proposed designs that are overly similar to a neighboring Tenant's storefront design. We wish to make the Mall as diverse and interesting as possible and enable each Tenant to make a singular statement with their design.





# CRITERIA MAIN CONTENTS

**1.0** **INLINE**  
CRITERIA FOR ARCHITECTURAL, SIGNAGE, AND TECHNICAL DESIGN FOR INLINE RETAIL LOCATIONS.

**2.0** **FOOD**  
CRITERIA FOR ARCHITECTURAL, SIGNAGE, AND TECHNICAL DESIGN FOR INLINE FOOD, FOOD COURT/HALL, AND RESTAURANTS.

**3.0** **BUILDING DETAILS**  
ARCHITECTURAL DETAILS, REQUIREMENTS AND REFERENCE PHOTOS BASED ON STORE POSITION.

**4.0** **DESIGN INSPIRATION**  
SUGGESTED DESIGN MOTIFS AND INTRO TO KEY DESIGN ELEMENTS.

**5.0** **PROPERTY INFO**  
PROPERTY LOCATION, CONTACTS, UTILITIES OVERVIEW, OPERATIONS, AND LOCAL PERMITTING INFO.

**6.0** **SUBMITTALS**  
REQUIREMENTS TO SUBMIT CONSTRUCTION DOCUMENTS, RENDERS, SIGN DRAWINGS, AND MATERIAL BOARDS.

**7.0** **ADDENDUM**  
SUPPLEMENTAL DESIGN AND CONSTRUCTION REQUIREMENTS AND DETAILS PROVIDED AS LINKS TO EXTERNAL DOCUMENTS.

## INTERACTIVE NAVIGATION

This Criteria is an interactive document. You may tap or click the top Navigation Bar or the Side Content Bar to navigate directly to that section.

## This page serves as a hub to the various sections included in this Criteria.

The sections in this Criteria break down the key categories of information to understand the design and construction requirements to incorporate a successful retail experience. Refer to the overviews included in the left side bar to learn more about the content included in each section.

It is the responsibility of the Tenant, its contractors, subcontractors, architects, engineers, employees, and agents to comply with terms of the Tenant Criteria, including the supplement documents included in the Addendum.

The intent of this criteria manual is to:

- Accelerate the leasing process by providing quick answers to questions about specific requirements.
- Establish the design expectations and technical requirements.
- Establish a coherent design by carefully curating and integrating within the mall.
- Guide the design standards.
- Answer basic questions about the design and construction process.
- Save time by minimizing design reviews.



# INLINE RETAIL CONTENT OVERVIEW

1.1

## DESIGN

CRITERIA FOR ARCHITECTURAL DESIGN REQUIREMENTS FOR RETAIL STOREFRONTS AND INTERIORS.

1.2

## SIGNAGE

CRITERIA FOR PRIMARY AND SECONDARY STOREFRONT SIGN DESIGNS.

1.3

## TECHNICAL

CRITERIA FOR TECHNICAL DESIGN ELEMENTS TO ENSURE YOUR STORE CAN INTERFACE WITH THE PROPERTY'S BASE BUILDING UTILITY SYSTEMS.

### SECTIONS OF INTEREST

*BUILDING DETAILS*

Includes property reference photos and specific storefront design details.

*PROPERTY INFO*

Includes information on the Property's building codes, area permitting, and required contractors.

*SUBMITTALS*

Outlines requirements on how and what to compile for submittals to the Landlord for design reviews.

*DESIGN INSPIRATION*

Provides visual inspirations for design aesthetics.

**The Inline Retail Criteria provides key technical information and design requirements to ensure your store enlivens the consumer experience and interfaces with the Center.**

The Tenant and the Tenant's Architect assume the following important obligations:

- Fulfill the intent of the criteria both in concept and in detail.
- Determine and respond to the actual physical conditions of the Tenant's location.
- Maintain and enhance the high standards of quality established in the construction of the Center.
- Ensure the quality of execution of all design material, finish, and detail concepts in the construction of the Tenant's improvement.
- Provide the required detail at all transitions from Tenant storefront to neighboring storefronts, as well as to the base building.





# DESIGN CRITERIA

- STOREFRONTS
  - ENTRY
  - POP OUTS / HEIGHTS/NEUTRAL PIER/CONSTRUCTION
  
- DESIGN CONTROL AREA
  - DESIGN REQUIREMENTS
  - PROHIBITED DESIGN ELEMENTS
  
- MATERIALS
  - GLAZING / WOOD
  - STONE / PLASTER / DECORATIVE GLASS
  - METAL / LEATHER
  - WALLCOVERINGS / SOLID SURFACE
  - PAINT / FAUX FINISHES / FABRIC
  
- INTERIORS
  - LIGHTING / FLOORING
  - CEILING / WALLS & PARTITIONS
  - RESTROOM / DOORS

## SECTIONS OF INTEREST

- BUILDING DETAILS
  - Includes property reference photos and specific storefront design details.
  
- PROPERTY INFO
  - Includes information on the Property's building codes, area permitting, and required contractors.
  
- SUBMITTALS
  - Outlines requirements on how and what to compile for submittals to the Landlord for design reviews.
  
- DESIGN INSPIRATION
  - Provides visual inspirations for design aesthetics.

**Tenants are encouraged to express the individuality of their brand through excellent design by forwarding thinking design teams.**

This Design Criteria focuses on strong design details visible from the Center common areas. Focusing on a strong storefront design enlivens the retail experience and draws customers in to shop.



## > STOREFRONTS

The Center's success is dependent on the creative design contributed by individual Tenants.

It is vital that your Storefront design is integrated with the look and feel of the Center's aesthetic.

The Building Details section includes specific storefront design requirements based on your store's location. These location based requirements must be incorporated into your Storefront's final design.





## > ENTRY

### ENTRY

Your storefront entry is a critical design feature to create an invitation to shop, as such all stores must express the entry as an identifiable part of the storefront. The underside of the entry portal soffit shall be finished to match the storefront.

#### I. SWING DOOR ENTRY

- Swing doors should be located in a recessed vestibule a minimum of 3' from the storefront.
- No door swing shall project beyond the maximum allowable primary projection line.
- Minimum allowable door height is 9'-0".
- All other doors are to be hinged or pivot-type doors. Doors are suggested to be the height of the glazed storefront.
- Recessed entry flooring shall match the Centers' flooring requirements.

#### II. OPEN STOREFRONT ENTRY

- An open storefront must also present an entry zone. Macerich will review all open storefronts for alternate articulation and dimensional elements for all storefronts.
- Tenants choosing to have an open storefront are required to secure the premises after business hours with a coiling, sliding or folding security closure which comply with the following design guidelines:
  - Shall be set back from the lease line a minimum of 4".
  - Shall coil overhead or coil, fold or slide horizontally to retract into pockets or enclosures to conceal from view during business hours.
  - All supports, tracks, guides and operating devices must be concealed flush with adjacent storefront finishes when closure is in the open position and be integrated into the storefront overall design expression.
  - Horizontal tracks are not allowed in the floor surface.
  - Exposed locking devices or latches are not allowed. Key switches shall be concealed and mounted within the Tenant storefront proper.
  - All supports to be provided by Tenant. Suspending closures from existing building structure is not allowed.





# > POP-OUTS / HEIGHTS / NEUTRAL PIER / CONSTRUCTION

## **POP-OUTS**

Three dimensional pop outs in both plan and height are required for all Storefronts in all new Tenant areas.

- When storefronts are visible from the upper level, special care must be taken so the top is finished to match the Storefront design.
- Exposed conduits, raceways, access panels or equipment may NOT be visible.
- All surfaces of any visible projections must also be finished to match.
- No dust or falling debris may collect on surfaces visible from upper levels. Tenant is responsible for the upkeep of all surfaces.
- Designs may incorporate sloping tops at no less than a 3 in 12 pitch to create a debris resistant surface.

## **STOREFRONT HEIGHTS**

All Storefronts must extend up to a maximum heights per the specific location of your store:

LEVEL 1

LEVEL 2

## **NEUTRAL PIER**

Tenant Storefronts are to abutt each other, separated by a 3/4" black, recessed, C-channel reveal. Tenant under construction is responsible for the installation of the reveal between adjacent storefronts, if not currently existing.

## **STOREFRONT CONSTRUCTION**

- All storefront construction shall be self-supported from the floor and independent of the building fascia and bulkhead structure.
- Storefronts may be braced to the overhead structure within the Tenant space.
- Connections to the deck, mall mechanical, electrical, plumbing, or fire protection equipment for support is not permitted. This includes ceiling splay wires.





## > DESIGN CONTROL AREA

The Design Control Area (DCA) is the zone extended from the storefront lease to 8'-0" inside your space, including all display windows and retail graphics, display fixtures, signs, materials, finishes, color and lighting fixtures within the area.

At Macerich, we take special interest in the DCA as an extension of the retail presentation and showcase of the store's merchandising. The intent is to convey excitement, and give the consumer a reason to shop.

Use of a professional Visual Merchandisers is highly encouraged. Design drawings shall have a display layout plan. The layout plan shall have cut sheets for fixture and/or mannequin types and include photographs of any existing storefronts a Tenant may have that will enhance the layout plan. A rendering is required if photographs are not available.

Stores with both interior and exterior presence must activate both DCA areas. Tenants are encouraged to maintain open visibility into their store to draw in customers.



# > REQUIREMENTS / WINDOW DISPLAYS / PROHIBITED ELEMENTS

## DESIGN REQUIREMENTS

- Ceiling must be a hard surface.
- Lighting fixtures must be consistent with the character of the Storefront design.
- Recess all lighting fixtures.
- A minimal profile track lighting system matching the color of the ceiling plane is allowed.
- Hard bases on the walls are required, including any permitted pop out areas.

## WINDOW DISPLAYS

Displays should be deliberate and integrated into the Storefront. Modulation of display systems and built-in architectural components will reinforce the design.

- Display cases must be adequately lit and ventilated.
- Digital monitors are permitted within 10'-0" behind glazing if integrated into the design and approved by Landlord. Coordinate with Tenant Coordinator for exterior applications and to confirm code or local requirements.

## PROHIBITED DESIGN ELEMENTS

- Track lighting is not permitted in the DCA.
- Temporary signs for sales or clearances shall not be hung in the DCA or affixed to the glass inside or outside.
- No pegboard, slat wall or metal shelving of any kind may be placed in or extend into any part of the DCA.
- Security devices or freestanding pedestals are not permitted. They must be integrated and concealed.
- Carpet, vinyl or rubber materials of any sort will not be permitted within the DCA.
- Exposure of incandescent bulbs and/or fluorescent tubes are not allowed.





## > MATERIALS

As an important aspect of presenting the Tenant's unique brand image, finish materials are to be composed, articulated and executed in a creative and quality manner.

All materials and applied finishes on the storefront are to be high-grade, durable, non-corrosive and code compliant. They are to be maintained by Tenant at the Tenant's expense. All materials and finishes are subject to Landlord approval, and the inclusion of natural materials is encouraged.

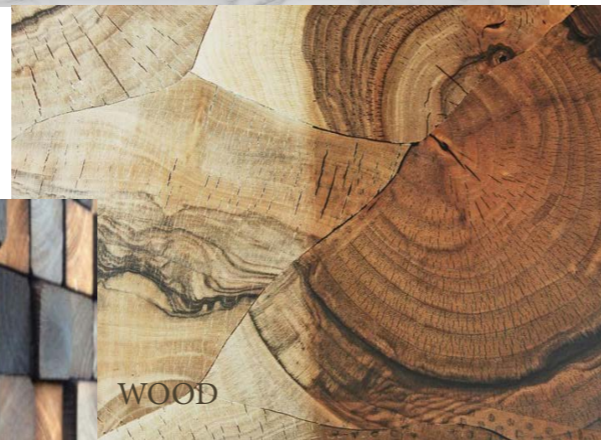



## > GLAZING / DECORATIVE GLASS

### GLAZING

Storefront glazing, particularly clear glazing, is a key component to establish design character and create an invitation for the customer to visit.

- A minimum of 60% of the Storefront is to be display windows with clear glass.
- Reflective glass (including extensive use of mirror) and/or tinted glass is not permitted on Storefronts or in the Storefront entry zone.
- Tinting or films applied after the glass is installed is prohibited.
- All glass shall be tempered. Glazing must be a minimum of ½" thick, and large panes of glazing must be of sufficient thickness to meet code and be properly supported.
- Tenants may be required to provide seismic clips to stabilize tall expanses of glass.
- Silicone sealant at glazing joints is not permitted.
- Butt-joint glazing is encouraged for show windows that in-fill larger Storefront forms.
- Glass shall be clear polished plate or tempered glass as required by code.
- Window mullions are required to meet all material and finish standards.
- Decorative glazing such as colored, beveled, sandblasted or etched glass may be used to create accent pattern and interest. Decorative glazing can be used as an accent, but must meet all material standards.



### DECORATIVE GLASS

Decorative glass may be considered to provide a unique feature to the storefront.

- In frame-less assemblies, glass panel joint details edges must be polished, ground or chamfered. Glazing channels at corner conditions must be mitered.
- All exterior glazing units must have a solar heat gain coefficient (SHGC) of not more than 0.27 and a U-value of not more than 0.28.
- Exterior glass must be a minimum of 1" insulated, low E units. 0.27 and a U-value of not more than 0.28.





## > WOOD/ STONE / PLASTER

### WOOD

Wood material can be used for Storefront construction but must comply with all local and national code requirements.

- Applications of painted or stained wood may include window frames, decorative trim, molding and solid areas, such as decorative bulkheads. In some cases, it may be used for larger architectural elements, such as columns and entablatures.
- Wood paneling and plank construction are not acceptable unless presented in a highly imaginative concept and approved by the Landlord.
- Wood specified for interior Storefronts must be kiln dried, mill quality hardwood and must meet local flame spread requirements (Class III 76-200), as well as comply with all code requirements.
- Painted wood must have a shop quality enamel finish. Wood without a paint finish must receive a clear, preservative sealant.
- A mock-up of the materials, colors, textures, or application may be required at Landlord's discretion.

### STONE

Granite, marble, limestone, travertine, slate, adoquin and other natural stone materials may be used for Storefront applications.

Stone may be polished, unpolished, sandblasted, flamed, honed, split-face or carved.

- Natural stone must be protected against staining and discoloration by means of sealers appropriate to the material.
- Craftsman-like attention to detail is required at all connections and transitions to other materials, and we recommend utilizing metal reveals for a clean finish.
- Corner and edge details must prevent visible unfinished edges. Exposed edges must be quirk mitered, chamfered or polished to match adjacent surface finish.

### PLASTER

Cement plaster (stucco) and Venetian plaster finishes may be considered for limited storefront applications.

- Apply an even texture of light dash, sand or smooth finish.
- Plaster or stucco should not be the primary Storefront material. Finishes should be used in combination with other high quality materials.





## > METAL / LEATHER

### METAL

Metal panel may be used to provide alternate texture on a portion of the storefront.

- High quality is expected for all metal applications, including careful finishing and quality fastener detailing.
- Metals may include: shop-painted aluminum and steel, stainless steel, solid brass, bronze, pewter, or enamel coated steel, and may be used for hardware, trim and panels when well designed and detailed.
- The following notes on metal material details must be called out on the submitted drawing set:
  - Minimum 1/2" thick fire-rated plywood or other solid substrate is required behind all metal panels.
  - Minimum 18 gauge metal panels are required.
  - All seams between metal panels must be identified on the storefront elevation and must be properly addressed during design review process.
- The following metal surface treatments are not allowed:
  - Oil canning (resulting from light reflection on an uneven or buckled surface)
  - Scratches
  - Warps, dents, occlusions
  - Visible seams or other imperfections
- Reveals, turn-in seams, welding or similar must be specified and detailed for approval. Metal panels will not be allowed to directly come into contact with adjacent panel or other materials.
- No visible fasteners are permitted.
- Lap joints and seams must be even, straight, and concealed when possible. Outside corners are to be mitered or continuous break shaped.
- Sealants on natural metals are required to prevent tarnishing and must be maintained by Tenant at Tenant's expense.



### LEATHER

The use of leather "tiles" for vertical application can add a level of depth and texture to the Storefront. However, these tiles should not be used at an elevation that can be reached by the general population due to the delicate finish and to prevent damage over time.

- The Landlord recommends keeping the use of leather tiles on the Storefront above 7'-0" AFF.

## > WALLCOVERINGS / SOLID SURFACES

### WALLCOVERINGS

Wallcoverings can add depth and texture to Tenant Storefronts, but need to be applied accordingly based on the durability of the product.

Vinyl, Paper, or Fabric Wallcoverings are not considered durable and are expressly prohibited in the use of Tenant Storefronts.

- Any wallcoverings located at pedestrian level (below 7'-0" AFF) must be extremely durable and rated by the manufacturer for high traffic use.
- Any wallcoverings located above pedestrian level (higher than 7'-0" AFF) must be durable and washable for maintenance purposes.
- Removable/repositionable wall coverings are not permitted for storefront use.
- All wallcovering applications must appear seamless and be securely affixed with commercial grade adhesive rated for high traffic use covering the entire back of the product.
- All maintenance of wallcoverings is by Tenant. No peeling, bubbling, or other separation of the wallcovering from the applied substrate is permitted to remain, and is the responsibility of the Tenant to repair in a time frame deemed acceptable by the Landlord.



### SOLID SURFACE

The use of large format solid surface panels can effectively mimic luxury materials in places where cost may be an issue (IE: Caesar Stone or Cambria), or to provide even, diffuse lighting elements in the storefront (IE: Lumicor or 3Form).

- All solid surface products must be rated for heavy duty commercial applications – residential quality products are not permitted.
- Joints, flat seams, and corner conditions of solid surface materials must be tight and seamless.
- All visible edges must be finished to the same level and quality as the front face of the material.
- If the body of the product is not consistent throughout, a mitered corner detail is required to keep the presentation clean.
- All corners and edges must be eased for safety purposes.
- No adhesive can be visible in the final application.





## > PAINT / FAUX FINISHES / FABRICS / TILE

### PAINT

- Surfaces should be maintained as an even and durable surface finish, at all times.
- Any paint application should show uniformity without evidence of touch-ups or batch variation.
- Paint should be colorfast, and well executed to prevent lap marks, brush marks, or poor coverage.
- Surfaces and materials shall be prepared and staged correctly to avoid problem conditions such as poor adhesion, sagging, chipping or flashing.
- Painted metal surfaces are not allowed.
- Painted gypsum board is not permitted on the storefront unless there is a factory applied finish of baked enamel or powder coat treatment.
- Painted MDF may be used with a finish process of 1 coat primer, 2 coats finish (sprayed and sanded between each step). Minimum thickness of the MDF is 3/4" on Storefronts.

### FAUX FINISHES

Faux finishes may be used at the Landlord's discretion.

- Actual samples of the faux finish must be submitted to the Landlord. Photographs of previous examples are helpful but may not be substituted for an actual sample.
- Faux finishes must be executed by a commercial artisan specializing in that medium.

### FABRICS

- Fabrics shall be commercial grade and tested in accordance with ACT Guidelines.
- Specifics for flammability and four aspects of fabric durability: Wet & Dry Crocking, Colorfastness to Light, Physical Properties, and Abrasion are to be documented for each fabric specified and available for Landlord review if requested.

### TILE

- Tile may be used in diverse applications and is encouraged to introduce light, texture, and graphic quality to a Storefront.
- Porcelain, cermaic, or glass tile in glazed or natural finishes may be used as accents and in limited field applications. Patterns over a large area must be sophisticated and well executed.
- Small intricate mosaic tile may be utilized for detail and accents only.
- Lapped or butt joints are not permitted. Outside cornered must be bull nose edge or special corner trim.
- Grout color should match the background color of the tile so as not to emphasise the grid.





## > INTERIORS > LIGHTING / FLOORING

**The store interior design should emphasize your merchandise and create an exciting experience for the customer.**

It is the Tenant's responsibility to survey, capture and address all existing conditions within the space.

### **LIGHTING**

Lighting can greatly contribute to the design of a Tenant's store, by emphasizing architectural forms as well as highlighting signage, adding color and visual drama to walls and other design elements. The creative use of dramatic lighting is encouraged at entries, show windows and merchandise displays.

- Fixtures must be positioned to avoid glare directed into public areas. Do not over light.
- Wall sconces or decorative lamping may be used to cast light onto storefront forms, provided that bare bulbs are not exposed and that the finish and form of these fixtures coordinate with the overall storefront design.
- Fixture cut sheets will be required to be submitted if this light form is used.
- Sconces shall be commercial grade in quality and size.
- Residential scaled sconces are not acceptable.
- Colors are subject to Landlord approval.
- 2'x2' or 2'x4' prismatic fluorescent lights are not allowed.

### **FLOORING**

- Flooring is required in the full premises including in the recessed entry conditions and storage areas of the store.
- Stores with less than 800 sf. require finished flooring with hard surfaces.
- Apron areas must be signed off with the Tenant Coordinator as part of the submittal documentation.
- Hard surface base is required in all sales areas.
- Ensure floor material is durable.
- Carpet must be commercial grade and meet local code required fire-proof ratings.
- Exposed concrete floors must be sealed.
- Transitions between flooring and common areas must be flush.
- Tenant is responsible to mitigate any/all ADA issues and clear with the appropriate municipality.

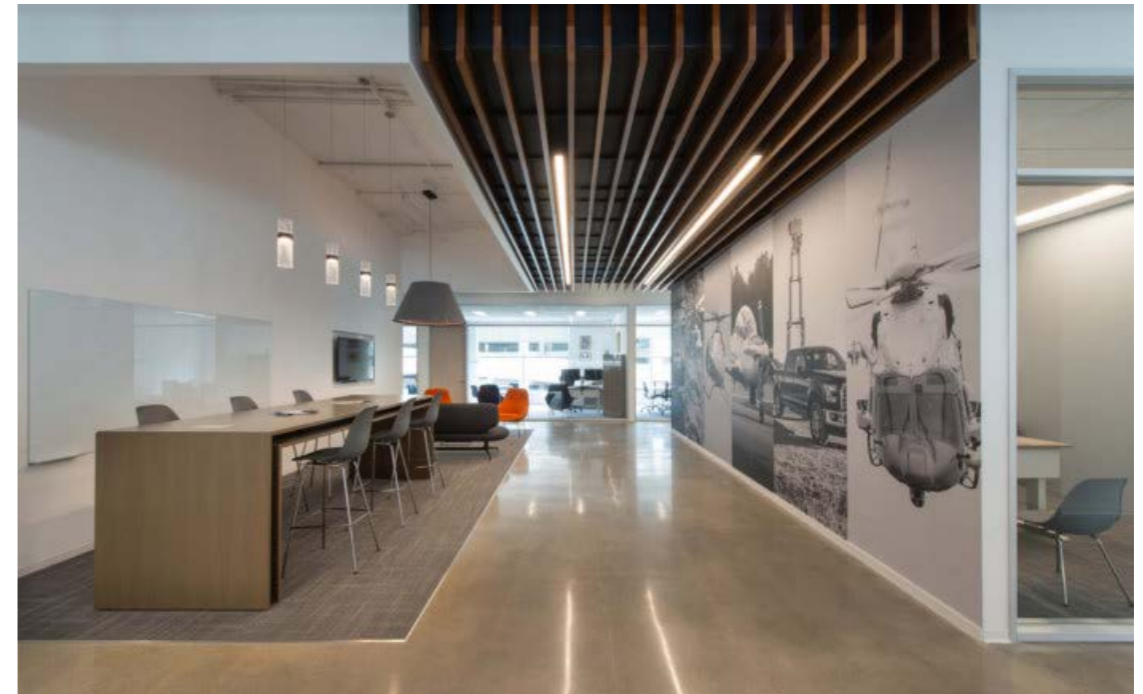



## > CEILING / WALLS & PARTITIONS

### CEILING

- Recessed entry conditions must have a finished soffit matching the storefront.
- Concealed light covers to highlight architectural elements are encouraged.
- Multi-level ceilings are encouraged.
- Gypsum wallboard, concealed spline, decorative patterned ceiling panels, and other “high-tech” materials are encouraged.
- Standard 24”x48” acoustical panels are not allowed in sales areas.

### WALLS & PARTITIONS

- Demising walls are not designed to accommodate cantilevered or eccentric loads. If Tenant plans to use a demising wall for support of shelf standards, light softs or heavy attachments, Tenant shall reinforce the wall as required by providing additional steel studs or independent supports for the shelf standards.
- Demising walls and ceiling shall be sound insulated to achieve a minimum STC rating of 50 by Tenants who produce above 80 dB (including but not limited to music stores, arcades, etc.) The Landlord will strictly enforce all Tenant’s right to quiet enjoyment of their Leased Premises.
- Tenant shall protect fire proofed columns and braces with gypsum board, and furr as required.
- The following are required for hair salons, pet shops and all food preparation type Tenants:
  - Walls containing “wet” areas to be constructed of metal studs with water resistant  $\frac{5}{8}$ ” type “x” gypsum board.
  - Demising walls of pet shops shall have sheet metal installed on studs, behind drywall, up 3’-0” from floor.
- When Tenant chooses not to install a ceiling within Tenant’s stockroom, Tenant shall extend the partition separating the stockroom from other areas of the store, to the underside of the structure above in order to isolate the stockroom from the sales area attic space. Tenant to verify if this is allowed by code.
- Metal or plastic laminate inserts are required for slatwall. No visible substrate at slats.
- Recessed wall standards are permitted.
- No open shelving with visible brackets or surface mounted systems are allowed.





## > EGRESS DOORS / RESTROOM

### EGRESS / SERVICE DOORS

- All secondary exit doors shall be backset so that the door does not swing into the corridor, or exit passageway.
- Doors entering a common exit passageway or corridor shall be labeled with the Tenant name and space number.

### RESTROOM

- 3" Floor drain and cleanout are required.
- Each restroom must have an exhaust system.
- A waterproof membrane beneath the finish floor surface up to a height of 4" along all walls is required.
- Floor finishes in toilet rooms shall be ceramic tile with a coved 6" base. Tenant is required to provide a waterproof membrane beneath the finish floor surface up to a height of 4" along all walls.
- Toilet room walls and ceiling shall be constructed of metal studs with water-resistant 5/8" type "x" gyp board.
- A water shut-off valve is required at eye level.



# SIGN CRITERIA

## Storefront signs are vital to the successful function of the Center.

The goal of this Criteria is to produce a colorful collage of signage that tastefully informs, delights, and stimulates the shopper.

## All sign materials must be consistent with the design theme, enhancing the storefront and evoking a positive retail image.

Broadway Plaza adheres to the Master Sign Program, dated October 12, 2015 which can be found in the addendum of this Criteria Manual. This document describes and regulates allowable signage at Broadway Plaza. As such that document supersedes the signage described in Section 4 of the Council approved Broadway Plaza Planned Development District Design Guidelines (dates January 7, 2014, Council approved December 10, 2013).

Tenant signage criteria address the allowable size, type and amount of signage for each Broadway Plaza tenant, with the exclusion of Anchor Stores, and individual pad buildings, which will be subject to independent sign approvals from the City of Walnut Creek's Design Review Commission. For the purpose of this document, an Anchor Store is defined as a stand-alone, single-tenant building (although it may be about other buildings), two or three stories in height, with a total building area exceeding 50,000sf. This will include any identification signage on such businesses located within Broadway Plaza.

The Tenant signage criteria addresses both permanent, as well as temporary signage, such as barricade graphics that may be erected while a store is under construction.

Any current tenant signage in place as of October 1, 2015 rendered non-conforming with the Tenant Signage Criteria in this Master Sign Program shall be brought into conformance or receive city/DRC approval to remain within a one-year period of the date of adoption of the [MASTER SIGN PROGRAM](#). The vertical blade at space C86 and any other signs previously approved by the DRC shall be exempted from this requirement.

### SECTIONS OF INTEREST

- BUILDING DETAILS**  
Includes property reference photos and specific storefront design details.
- PROPERTY INFO**  
Includes information on the Property's building codes, area permitting, and required contractors.
- SUBMITTALS**  
Outlines requirements on how and what to compile for submittals to the Landlord for design reviews.
- ADDENDUM**  
Includes additional info on exterior signage requirements.





# TECHNICAL CRITERIA > CONTENTS

- ELECTRICAL**
  - POWER SOURCE / METER*
  - REQUIREMENTS / SYSTEM REUSE*
  - DATA & COMMUNICATIONS*
  - LIGHTING*
  
- LIFE SAFETY**
  - SPRINKLER*
  - FIRE ALARM*
  - EGRESS*
  
- PLUMBING**
  - REQUIREMENTS*
  - GAS*
  
- MECHANICAL**
  - LOAD CALCULATIONS / GENERAL REQUIREMENTS / EXISTING SYSTEMS / EXHAUST*
  - ROOFTOP EQUIPMENT*
  - ROOFTOP DETAILS*
  
- STRUCTURAL**
  - DESIGN DETAILS*
  - SEISMIC JOINT DETAILS*

## SECTIONS OF INTEREST

- BUILDING DETAILS**

Includes property reference photos and specific storefront design details.
- PROPERTY INFO**

Includes information on the Property's building codes, area permitting, and required contractors.
- SUBMITTALS**

Outlines requirements on how and what to compile for submittals to the Landlord for design reviews.
- ADDENDUM**

Includes additional info on exterior signage requirements.

## The Inline Technical Criteria provides buildings details and design requirements for the Center's technical systems.

It is the Tenant's responsibility to verify existing conditions and comply with all applicable codes and standards for technical systems.

Tenants are required to adhere to the full criteria during their design and construction.

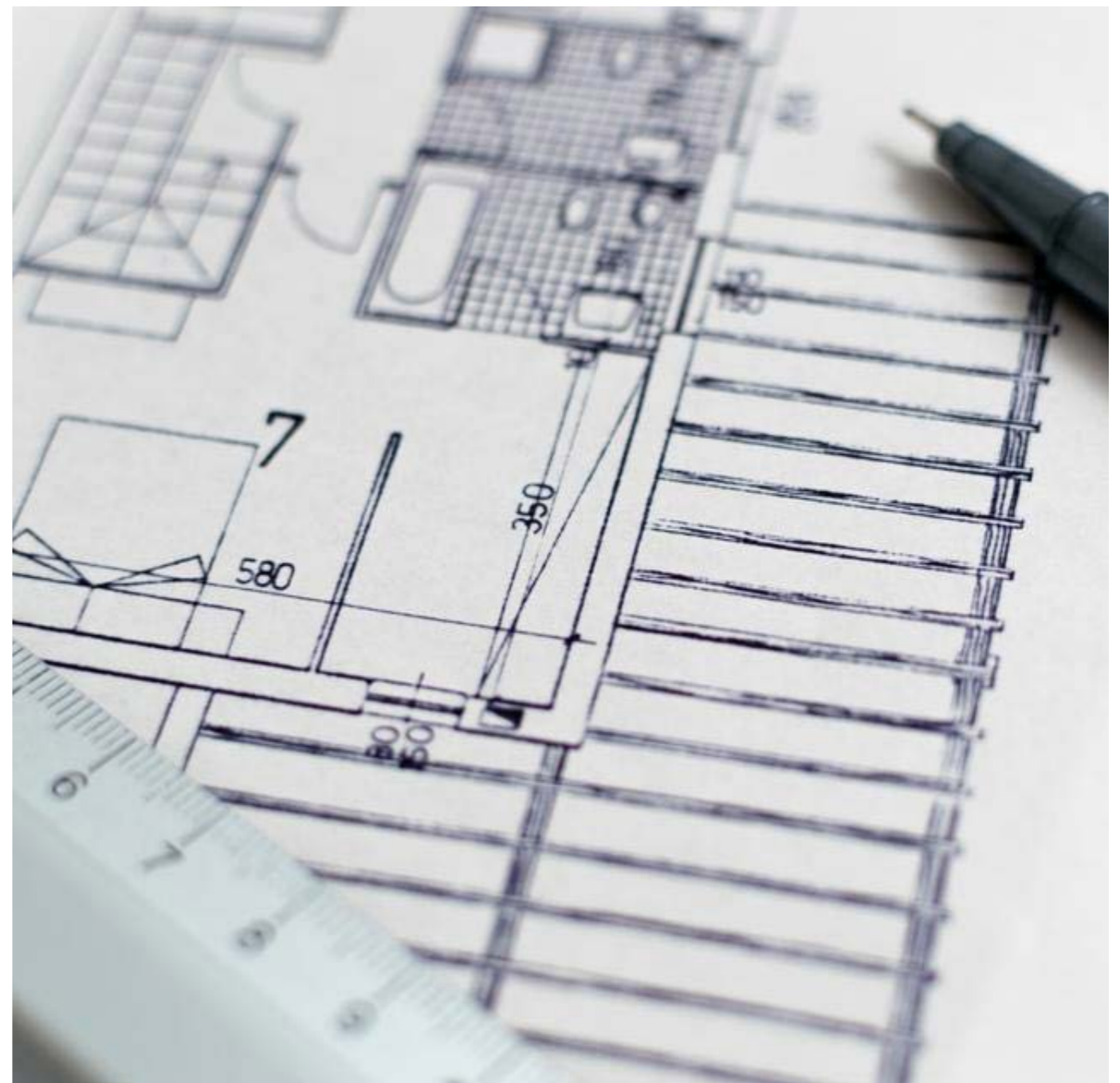

## > ELECTRICAL > POWER SOURCE / METER

### PROVIDED POWER SOURCE

Tenant shell spaces typically provide an empty conduit to a main power source. The main power source available for Tenant connections will be 277/480v or 120/208v, 3 phase, 4 wire available from the nearest electrical room.

The Landlord may provide temporary electrical service to the Tenant, during construction. The charge for this temporary power will be paid by the Tenant as per the Tenant Construction Rules and Regulations. Temporary wiring needed to work in the space should be connected to the Tenant's electrical service and not common area outlets.

#### I. TENANT REQUIREMENTS

Tenants are required to meet the following requirements related to connecting to their power source:

- **MAIN POWER SOURCE CONNECTION** must be performed by the Landlord's designated electrician, at the Tenant's expense.
- **FEEDERS** to the tenant space are the Tenants responsibility, installation of a dry type transformer, panels and complete distribution throughout their space.
- **DEMAND CHECK METER** must be installed in the mall electric room or in Tenant's space for those areas of the mall where applicable. (Check with the mall's Operations Manager or Tenant Coordinator prior to construction start).
- **UTILITY COMPANY ARRANGEMENT** is a Tenant responsibility to arrange for electrical service and meter at Tenant's expense.
- **LARGER CONDUIT**, if required, is a Tenant responsibility to install from the power source to the demised premises.

### METER DETAILS

Electrical use is sub-metered and charged by the Landlord. However, check with your Tenant Coordinator as some parts of the Center are not sub-metered. If a space is not sub-metered, it is the Tenant's responsibility to contact the Utility company for meter installation.

#### I. ELECTRIC METER REQUIREMENTS

- **REVENUE GRADE** meters are required.
- **DISPLAY** must be at least 6-digits.
- **METER MUST READ** demand (kW) and usage (kWh).
- **METER MUST CAPTURE** the electric usage of the entire Tenant space, including HVAC units. If this is not possible, then it must be noted.
- **METERS WITH CT** must note if a multiplier is required and what the multiplier is on the face of the meter.

#### II. EXISTING METERS

If there is an existing electric sub-meter in the Tenant's space:

- **RECOMMISSIONING** the meter is the Tenant's responsibility to ensure proper installation and functionality or;
- **NEW METER** may be installed by the mall required vendor, and will be at the Tenant's sole cost.





## > REQUIREMENTS / REUSE

### SYSTEM REQUIREMENTS

- **NO DIRECT ATTACHMENT** to the slab, roof deck, ductwork, piping or conduit above. Conduit and raceway hangers, clamps, light fixtures, junction boxes, supports, etc. must be fastened to joists and/or beams.
- **ACCESS PANELS** must be provided at all junction box locations and at smoke detectors above the ceiling.
- **IDENTIFY** all Tenant equipment in the Mall electric room with clear labels that include the Tenant name and space number.
- **TENANT EQUIPMENT** typically includes, but is not limited to: all outlet boxes, floor boxes, wire raceways, power/telephone poles, plug-in molding, wiring devices, and hanger supports for a complete distribution must be furnished and installed by Tenant.
- **EQUIPMENT POWERED BY TENANT** typically includes, but is not limited to: VAV units, water heater, store fixtures, signage, music systems and any other fixtures or equipment provided by Tenant.
- **FEEDERS** are typically the Tenant responsibility to the Tenant space.
- **UL LABELS** on all material and equipment must be new and of a commercial grade and where such labeling applies.
- **WATERTIGHT FLOOR BOXES** are required.
- **PULL BOXES/J-BOX MATERIAL** must be a minimum of 12 gauge galvanized steel outlets. Boxes in walls must be galvanized pressed steel or case metal. Caulk around boxes to eliminate noise transmission.
- **CONTROLS** including Manual or magnetic starters, switches, contactors, relays, time switches, safety devices, dimmers and other controls must be commercial type with heavy duty ratings and must be installed in strict conformance with the manufacturer's recommendation and applicable codes.
- **EXPOSED WIRING** is not permitted. All wiring of any type must be installed in conduit or must be metal clad cable (MC). Metal clad cable will only be allowed for concealed branch circuit wiring within the demised premises. Flexible conduits must be used for connections to vibrating equipment.

- **COPPER** is required for all wiring.
- **CONDUIT** is required for all wiring, including low voltage.
- **GROUND SYSTEM TO BUILDING STEEL** as structure is designed with a "UFER" grounding system.
- **MAIN CIRCUIT BREAKER** for the Tenant will be furnished and installed by the Landlord at the Tenant's expense.
- **SERVICE SIZE** requested by Tenant is subject to approval by Landlord. If the Tenant's electrical requirements exceed the standard size provided by the Landlord, the Tenant will submit total Load Calculations to confirm their requirement. Tenant is responsible to confirm the service size before work commences.
- **SLAB TRENCHING** is not permitted without written permission from the Landlord. Tenant to provide all structural support needed if trenching is permitted, including written certification to the Landlord that the trenching has not affected the integrity or weighty capacity of the slab.
- **GRADE LEVEL SLAB** requires electrical conduit to be installed at least 4" under the slab with Schedule 40 PVC conduit. Conduit must not be installed in the slab or less than 4" below slab.

### REUSE OF EXISTING ELECTRICAL SYSTEMS

Tenant's electing to re-use the existing electrical system (if applicable) in their Tenant space shall:

- **SUBMIT A LETTER** to the Landlord from the Tenant's electrical engineer stating that the existing electrical system is not being altered.
- **VERIFY SYSTEM CONNECTS** to the building management system for lighting controls and Fire Alarm. Tenant shall use mall required contractor at Tenant's expense to ensure code-compliant, connected system is complete.



## > DATA & COMMUNICATIONS / LIGHTING

### DATA AND COMMUNICATIONS – INSTALL AND PROVIDER REQUIREMENTS

Telecommunications service is provided and administered throughout the Center by Granite Grid. The service includes a dedicated concierge customer service representative for each Tenant, high-bandwidth service (tailored to suit Tenant demand), centrally coordinated installations, moves and repairs.

- **ACCOUNT SETUP AND SERVICE INSTALLATION** is the Tenant responsibility to coordinate direct through Granite Grid. Other data providers are not permitted at this property as they do not have an access agreement in place. **\*\*It is highly recommended to coordinate service install a minimum of 4 weeks in advance.**
- **TELEPHONE DEMARC WORK** must be performed by Landlord's approved telephone subcontractor.
- **TELEPHONE SERVICE** is the Tenant responsibility to contact the local Telephone Company and install within their premises.

### LIGHTING – SYSTEM REQUIREMENTS

- **LIGHTING IN TENANT SPACE** is the Tenant's responsibility. The Tenant will not install any lighting outside the Tenant's space with the exception of Mall required standard lighting at back doors. These fixtures shall be photo cell controlled.
- **LIGHTING SCHEDULE** is required for review in conjunction with a reflected ceiling plan.
- **TIME CLOCK** is required to control display window lighting and be on during the hours the Shopping Center is open.
- **DISPLAY WINDOW LIGHTING** at the ceiling must be glare-free and at approved levels at the storefront glass line and not hang down below the top of storefront glass.
- **RECESSED INCANDESCENT DOWN LIGHTS** are permitted.
- **DECORATIVE LIGHTING FIXTURES** for storefront illumination, such as luminous ceilings, chandeliers, pendant or wall units or clear type glitter strips are permitted if approved by Landlord. No strobe, spinner or chase type lighting shall be used.
- **CODE REQUIRED LIGHTING** such as exit, emergency and night lights must be provided throughout.
- **SALES AREA FLUORESCENT LIGHTING** must be recessed and must use metal parabolic louver type lenses with a minimum of 18 cell configuration for a standard 2' x 2' fixture. Bare lamp fluorescent or fluorescent fixtures with acrylic prismatic lenses may be used only in concealed areas or stock rooms.
- **TRACK LIGHTING** may be used if the track is painted to match the ceiling color.
- **LIGHTING CONTROL SYSTEM** is the Tenant responsibility, including connection to the Building Management system and connection to the Fire Alarm system.





## > LIFE SAFETY > SPRINKLER / FIRE ALARM / EGRESS

### SPRINKLER SYSTEM REQUIREMENTS

- **SPRINKLER MODIFICATIONS** are the Tenant's responsibility, designed and installed in accordance with NFPA 13.
- **SPRINKLER DESIGN AND INSTALLATION** must be performed by the mall required sprinkler contractor.
- **DESIGN CONTROL AREA** requires flush mount heads.
- **FIRE EXTINGUISHER REQUIREMENTS** are the Tenant's responsibility to confirm with the local or state fire marshal relating to quantity and location of fire extinguishers. At minimum, Tenant is to install at least one wall hung, 2A 10BC dry type U.L.- listed fire extinguisher.
- **PIPING** must be as close to walls and as high to underside of roof framing as possible.
- **LANDLORD NOTIFICATION** is required in writing at least 24 hours in advance of making any modifications to the sprinkler systems. Contractor must notify the fire department and any alarm monitoring company for verification that the system is fully drained. The contractor must notify the Landlord when the system is back on line.
- **CLEARING ALARMS** must be coordinated with Security or Mall maintenance supervisor at least 60 minutes prior to any drain down. Contractor shall remain for one (1) hour after the system has been refilled to check for leaks or other problems.
- **OVERNIGHT DRAINING** is not permitted. All systems have to be charged and operational when worker leave for the night.
- **SPRINKLER WORK HOURS** must be done between 7:00 AM and 4:00 PM Monday through Friday, so the fire system can be filled and tested by 5:00 PM. See the Tenant Contractor's Rules and Regulations for the cost for each shut down of the system, which is required to be paid before the system is drained. The Mall staff or approved contractor will drain and fill the system.

### FIRE ALARM REQUIREMENTS

- **FIRE ALARM DETECTION SYSTEM** is a Tenant responsibility to provide within the Tenant space as an extension of the Landlord's building-wide addressable fire alarm system.
- **FIRE ALARM INSTALLATION** must be performed by the Landlord's designated contractor.
- **FIRE ALARM TIE-IN** to the building wide addressable system must be performed by the Landlord's designated contractor.
- **OCCUPANT NOTIFICATION** must be provided within tenant spaces (on a tenant-by-tenant basis) that exceed the Code's thresholds based on the occupancy classification of the individual tenant space.

### EGRESS REQUIREMENTS

- **FIRE BARRIER FROM ADJACENT SPACE** must be separated by at least 1-hour fire barriers with 60 minute opening protectives.
- **FIRE BARRIER FROM EXIT STAIR DISCHARGE** must be separated by 2-hour fire barriers with 90 minute opening protectives.
- **AUTOMATIC SPRINKLER SYSTEMS** must protect passageways.
- **SMOKE DETECTION SYSEM** must protect passageways.
- **GAS PIPING**, if distributed along the exit passageway routes, will be separated from the exit passageway by fire rated construction and will not be considered to be located within the exit passageways.
- **ALLOWED UTILITIES** in exit passageways are limited to; Electrical wiring (no higher than 480 volts phase-to-phase and 277 volts phase to-neutral) in electrical conduit, Low-voltage wiring (security, music, telephone, data, etc.), enclosed junction boxes, Fire alarm equipment and wiring, Noncombustible piping, and Mechanical ductwork.
- **PROHIBITED UTILITIES** in exit passageways include; Electrical equipment such as panels, switchgear, and transformers, Grease traps, and Natural Gas piping.



# > PLUMBING > METER / SYSTEM REQUIREMENTS

## SYSTEM OVERVIEW

Tenant shell spaces are typically provided a domestic cold water line and sanitary line stubbed into the space.

The following criteria must be followed during the design and construction of the Tenant space:

## WATER METER REQUIREMENTS

- **INSTALL** must be by a Landlord approved electrician.
- **VERIFICATION AND APPROVAL** of install must be obtained by the Operations Manager, or a member of the Operations staff at the property.
- **PROOF OF INSPECTION** sent to the Tenant Coordinator including:
  - Date of installation or recommissioning
  - Meter make and model
  - Picture of the meter at time of installation or recommissioning
  - Units that the meter reads in
  - Multiplier, if applicable
  - Confirmation that the meter covers whole tenant space

## SYSTEM REQUIREMENTS

- **SHUT OFF VALVE** located at eye level in a wall behind a labeled access door is required. Locate in or near employee restroom and/or as designated by Landlord.
- **COPPER** is required for all domestic supply lines and condensate lines.
- **ELECTRIC WATER HEATERS** are required for domestic hot water.
- **SANITARY VENTS** through the roof shall be a minimum of 4" and extend a minimum of 8" above finish roof. All roof repairs to be by the Landlord's required roofer at Tenant's expense.
- **ABOVE GROUND SANITARY VENTS** (other than food waste) must be service weight BUILcast iron, with fittings matching the same weight as the pipe.
- **FLOOR DRAINS** are required in the toilet room and in all "wet" areas.
- **WATERPROOFING** must be installed in all "wet areas" such as kitchens, restrooms, mop sinks, drinking fountains, etc. The waterproof membrane must extend 4" vertically on all demising walls. This membrane will be water tested by the General Contractor and inspected and signed off by Mall Personnel. If the membrane fails the water test, it must be replaced.
- **CLEAN OUTS** must terminate flush with the finish floor or wall. No clean outs are permitted above the ceiling. Floor or wall cleanouts must be provided every 50' with ready access.

- **GARBAGE DISPOSALS** are not allowed.
- **HAIR SALONS/PET SHOPS** must provide hair and solids interceptors on all sinks and basins which may receive human or animal hair. After installation, these hair interceptors shall be properly maintained so as to keep the sanitary system free from any adverse conditions. A maintenance contract with Mall-approved vendor is required to be submitted for record with Mall Operations
- **HAIR RECEPTORS** must be installed on all sinks, basins, and special sanitary units which may in any way receive human or animal hair.
- **KITCHEN SINKS** including pot sinks, scullery sinks, pre-wash sinks and other kitchen units must be connected to a grease trap.
- **DISHWASHERS** may not be connected to grease trap.
- **GREASE INTERCEPTOR** must be designed and approved by Landlord prior to installation, especially if located outside the lease line.
- **OIL COLLECTION AND HAULING SYSTEM** is required for Tenants with fryers or other grease/oil generating equipment that does not run through an interceptor. Landlord does not provide a centralized collection point.
- **BACKFLOW PREVENTERS** are required for food service, hair salons or other Tenants with equipment or operations that have the possibility of backflow. These must be certified and acceptable to the water district and checked yearly or as required by the local authority having jurisdiction.
- **ADA RESTROOMS** are required in every Tenant space with a minimum of one water closet and one lavatory and in accordance with local code officials and must include a 3" floor drain. Mop sinks and water fountains must be installed per local code requirements. An exception to this requirement is only permitted for Food Court Tenants who are within close proximity to the public restrooms upon approval of the Landlord and local code official.
- **WATERLESS URINALS** are required in tenant restrooms when urinals are used.
- **LOW-FLOW WATER CLOSETS** using 1.6 GPF or less gallons per flush are required where water closets are used.
- **OPERATION SENSORS AND LOW-FLOW HEADS** using 0.5 GPM or less are required if Tenant is installing a Restroom.





**GAS SERVICE**

Gas may be available at the Center but is generally not available to Retail Tenants. If available, Tenant, at its sole cost and expense and in compliance with local code must procure gas service to and within the demised premises and will make all necessary arrangements with the local Gas Company for such service.

**I. SERVICE REQUIREMENTS**

- **GAS METER INSTALLATION** at gas meter header is the responsibility of the Tenant.
- **GAS PIPING INSTALLATION**, when allowed, is the responsibility of the Tenant to provide and install. Roof piping must be placed on pillow blocks or similar arrangement. All roof repairs to be by the Landlord's required roofer at Tenant's expense.
- **PRESSURE REGULATORS** required for connection to Tenant's equipment is the responsibility of the Tenant. Coordinate with Landlord for regulator vent routing.
- **SEISMIC AND MANUAL SHUTOFF DEVICES** are required for the entire gas piping system and equipment or fixtures and color coded or identified as such as required. Seismic valves must be: UL- approved; FM-approved; or, ACSE 25-compliant. All new development and newly tenanted restaurants need to have seismic gas shut-off valves installed on Landlord side of the meter, at each individual space.

# > MECHANICAL > LOAD CALCS / GENERAL / EXISTING / EXHAUST

Tenant spaces must provide stand-alone HVAC systems through package rooftop units placed directly over their space.

## LOAD CALCULATIONS

- **HEATING LOAD CALCULATION** must maintain the minimum space temperatures in sales and public spaces of 68 degrees F and 50 degrees F in non-public spaces.
- **COOLING LOAD CALCULATION** must maintain the minimum space temperature of 73 degrees F and a maximum of relative humidity of 55 degrees F and shall take into account all interior heat producing items such as people, equipment, roof and exterior walls.

## GENERAL REQUIREMENTS

- **VIBRATION ISOLATORS** are required to be installed on all HVAC equipment, whether on the roof or within the Tenants space.
- **MAXIMUM NOISE** criteria of NC40 is required for all spaces except kitchens and other similar work areas.
- **DUCT MOUNTED SMOKE DETECTORS** are required for systems that total 2,000 CFM or greater and must be connected to the main fire alarm panel, if applicable. Each duct smoke detector must have a remote key operated reset/test device mounted within the Tenant space and an addressable relay module. Use Landlord's designated contractor for connection to the main fire alarm loop. The cost associated in monitoring Tenant's space will be the Tenant's responsibility and will be included in Tenants monthly billing.
- **AIR BALANCE REPORT** is required prior to closing out construction and will be performed by an independent test and balancing agency at the sole cost and expense of the Tenant.
- **BOTTOM FED HVAC** units are required for supply and return air.
- **CONDENSATE LINES** from HVAC units must be copper, run at right angles, drain into the Tenant space, and (if applicable) secured to the roof per mall required roofer's specifications.
- **RETURN AIR DUCT** must be from the finished ceiling back to the HVAC unit. Ceiling return air plenum is not acceptable.
- **FIRE DAMPER ASSEMBLIES** (including sleeves and installation procedures) must be UL listed and approved by the building inspector preceding installation. Install duct and ceiling access to fire dampers. Smoke detectors may be required in all return air or exhaust ductwork. The detectors will over ride and shutdown the air handling equipment when smoke is discovered.
- **FIBERGLASS DUCTS** are not permitted for HVAC trunk lines. Flex duct is permitted for run outs within the Tenant premises and is limited to a maximum distance of 4'.
- **LOWER LEVEL TENANTS** in Buildings 1, 2 and 3 must install units of 4.5 tons or less. If units are larger, Tenants will have to provide 100% fresh air intake as the Landlord's system is not designed to provide that.

## EXISTING SYSTEMS

The Lease may allow some Tenants to reuse existing HVAC system equipment. In such cases, the following requirements must be followed:

- **CONFIRM** the existing system meets the Tenant Criteria requirements.
- **REPLACE** any units the Landlord deems in need of replacing. This may occur anytime during the terms of the Lease. Replaced units must adhere to the Tenant Criteria.
- **REUSE** of equipment older than 5 years is not permitted.
- **ALTERATION** of the existing system must be submitted and approved by the Landlord.
- **SUBMIT DOCUMENTATION** of the following prior to opening:
  1. A letter from an HVAC contractor asserting that the HVAC unit(s) operate in "like-new" condition.
  2. A copy of the maintenance agreement for the unit(s).
  3. Photographs of the existing unit(s) provided by the Tenant's HVAC maintenance contractor.

## EXHAUST REQUIREMENTS

- **ODOR PRODUCING TENANTS** such as restaurants, pet shops, hair salons, nail salons, and the like must maintain 10% negative air pressure with respect to the Mall by providing make-up air equal to 90% exhaust air volume.
- **SEPARATE MAKE-UP OUTDOOR AIR SYSTEM** may be required to balance Tenant's exhaust system. Spaces that require exhaust must be designed to provide negative air pressure relative to adjoining conditioned spaces to prevent odor transfer.
- **ROOF MOUNTED EXHAUST FANS** must be ducted to ceiling grilles located approximately in the center and rear of the demised premises and specifically near the area where the odors are generated. The system shall be designed to cause the exhaust air to gravitate from the Mall common area to the odor producing area and then exhausted out.
- **EXHAUST FANS** must be interlocked with the light switches for the store customer service area.
- **OPERATION** of the combined HVAC and exhaust system must be on during all hours that the Tenant is open for business.
- **STORE EXHAUST SOLUTIONS** shall not include air filtration systems or bathroom exhaust fans.





# > EXHAUST / ROOFTOP EQUIPMENT

## SPECIFIC REQUIREMENTS FOR ODOR PRODUCING TENANTS

- **NAIL SHOPS** may be required to install scrubbers. This will be determined on a case by case basis.
- **ODOR PRODUCING AREAS** must include the necessary equipment to remove any odors. This work will be approved in writing by the Landlord and at the sole expense of the Tenant. Examples of such Tenant's include; hair or nail shops, pet shops, and food preparation shops.
- **ROOF VENTILATOR** model is required to use motor driven and factory curb Supreme upblast installed at a minimum of 40" from roof membrane to discharge. Use a gauge welded exhaust duct. Provide makeup air no less than 85% of amount of exhaust.
- **SPECIAL MAKEUP AIR** as required by special conditions such as grills, restaurant exhaust systems, etc., will be provided by the Tenant. Along with the HVAC unit, the Tenant may use an evaporative cooler.
- **SMOKE DETECTORS** may be required in all return air or exhaust ductwork to override the air handling equipment and provide shutdown when smoke reaches the equipment.

## KITCHEN EXHAUST REQUIREMENTS

- **LANDLORD REVIEW** is required to ensure the exhaust does not compromise the ventilation air of adjacent mall roof top units.
- **EXHAUST FAN** must be a SWSI centrifugal fan which must be fitted with a minimum 10' stainless steel upblast. Guy wires must be attached to the roof in order to secure the stack. Use the mall roofer for connection of the guy wires at Tenant's expense.
- **GREASE GUARD CONTAINMENT SYSTEM** (or approved equal) must be installed to protect the Landlord's roof. A quarterly maintenance program must be in-place for the grease containment units. Proof of the maintenance contract must be presented to Operations Manager prior to the store opening.

## ROOFTOP EQUIPMENT REQUIREMENTS

- **PIPING** for the rooftop equipment must be provided and installed by the Tenant in coordination with the Landlord.
- **INSTALLATION INFRASTRUCTURE** including all curbs, supports, lintels, pipes, ducts, vent caps, air inlets, exhaust hoods, louvres, flashings, counterflashing's, etc. are the Tenants responsibility.
- **CURB ADAPTERS** are only permissible at the discretion of the Landlord.
- **PAVERS** must be placed around the roof top equipment and from the main pathway to the equipment in order to protect the roof from traffic.
- **EQUIPMENT SCREENS** for rooftop shall meet Landlord requirements. All equipment must be hidden from public view from the parking lot per City of Los Cerritos.
- **PAINTING EQUIPMENT** including screening, equipment, ductwork, and piping is required to match the roof deck per Landlord specifications.
- **ROOF MEMBRANES** are required for mounted grease exhaust equipment and shall be a single 60mil sheet of TPO roof membrane, loose and laid over the base mall primary roof membrane. This additional sheet of TPO shall be installed minimum 5' beyond all roof top kitchen equipment and help in place by concrete pavers at the corners and or as required to keep the membrane in place and afford the ability to replace as necessary when it becomes soiled.
- **LABELS** are required on all Tenant equipment.
- **ABANDONED EQUIPMENT** must be fully removed, including any associated curbs and patched accordingly.
- **120-VOLT OUTLETS** are required for all HVAC units from the Tenant's electrical service mounted to the unit on the rooftop.
- **EXPOSED DUCTWORK** is not allowed on the roof.
- **WEATHERHEAD** is required when multiple A/C refrigeration lines penetrate the roof.
- **SEAL NEW PIPE PENETRATIONS** though the roof with new prefabricated lead or metal pipe sleeve flashing. Flashing flanges should be installed in a manner acceptable to the roofing manufacturer and the Landlord.
- **CONTROL AND ELECTRICAL WIRING ROOF PENETRATIONS** shall be made through the equipment curb or roofer required flashing.



# > ROOFTOP EQUIPMENT

## I. ROOFTOP EQUIPMENT LOCATION REQUIREMENTS

- **VISIBILITY OF EQUIPMENT** from parking lots are adjacent streets is not permitted. Locate all roof top equipment as far from side walls as possible. Otherwise, equipment must be screened.
- **DISTANCE BETWEEN FRESH AIR INTAKE AND EXHAUST** units shall be a minimum of 15’.
- **FRESH AIR INTAKE** cannot draw in from Tenant exhaust. It is the sole responsibility to design and locate the distance such that Tenant’s exhaust cannot be drawn into the Fresh Air Intake of ANY existing roof top equipment.
- **DISTANCE ROOF PENETRATIONS** so that they may not be so close to one another that they interfere with proper flashing, or be installed in any roof waterway or area of the roof which ponds water. If placement of any curb or platform causes restriction of water flow and/or creates a ponding situation, a cricket will be constructed at the upslope side of the curb. Crickets can be formed from Perlite roof insulation to provide a minimum slope of 1/4” per foot.
- **DISTANCE BETWEEN NEW IMPROVEMENTS** and existing parapet walls, equipment curbs, or any rooftop projection, should be no less than 24” to allow for proper flashing and sealing of the roof membrane.

## II. ROOFTOP STRUCTURAL REQUIREMENTS

- **STRUCTURAL ENGINEER** registered in the state in which the work is being performed must be used to design and evaluate equipment placement and provide structural drawings and detail for Landlord’s review.
- **LOCATE** roof top equipment over major structural elements.
- **NORDSTROM WING ROOFTOP EQUIPMENT** is to be installed within a specific roof zone designed to carry the additional weight. Check with the Operations Manager or Tenant Coordinator as to the exact location of the zones in this area.
- **REINFORCE** the roof system to adequately support the weight of any equipment added.
- **REMOVAL** of structural or miscellaneous bridging, blocking, etc., is not permitted.
- **MODIFICATIONS** to the existing structure must be approved by the Landlord before any work begins.
- **AT WORK COMPLETION** the Tenant’s structural engineer shall submit a letter stating that the roof top equipment has been installed in accordance with the engineer’s recommended design.
- **REMOVE AND DISPOSE** existing rooftop equipment that is not being used by the Tenant of at the Tenant’s expense.

## III. PLACEMENT NEAR SOLAR PANELS REQUIREMENTS

- **DO NOT PLACE** equipment within 10 feet of any solar inverter or AC junction box.
- **AVOID INTERFERENCE** with solar panel production by placing objects no closer than the distance defined as 2 times their height. For example, if a 4 foot HVAC unit is installed, it must be located at least 8 feet away from a solar panel. However, in no cases, regardless of the height shall an obstacle be placed within 3 feet of solar equipment.
- **DO NOT ADD** conduits, pipes or other devices to existing conduit carrying devices.
- **DO NOT ROUTE** wires, pipes or other devices across or over existing solar equipment.
- **LANDLORD MUST REVIEW AND APPROVE** all modifications within 20’ of solar equipment.

## IV. ROOFTOP WORK

- **MALL APPROVED ROOFING CONTRACTOR** is required for all roof work throughout the center.
- **WARRANTY COMPLIANCE** is the responsibility of the Tenant and mall roofing contractor.
- **ROOF ACCESS** shall be coordinated and scheduled through Mall Operations.
- **DAMAGE** to the roof structure caused by hoisting installation and the maintenance and/or servicing of Tenant’s equipment will be the sole cost and expense of the Tenant to repair.
- **QUALITY OF WORK** is subject to inspection by the Landlord and, if found unsatisfactory, reject.
- **WELDING BLANKETS** are required blankets to protect Landlords roof during any welding on the roof level.
- **WELD INSPECTIONS** may be required at the sole cost and expense of the Tenant.
- **COATING** on all materials, welds, connections, etc. installed by Tenant for the HVAC system is required to withstand corrosion.
- **WORK DURING INCLEMENT WEATHER** is not permitted. Tie-in of flashing materials to moist or dusty surfaces should not be attempted.
- **RESTRAIN** all electrical conduit, metal pipe, or plastic piping to appropriate sized wood blocking set into roofing cement. Attachment to blocking should allow for movement due to thermal expansion and contraction.
- **USE APPROVED ROOFING CONTRACTOR** to tie in platforms, curbs, and sleepers into the existing roof membrane, at the sole cost of the Tenant, in a manner acceptable to the roofing manufacturer and the Landlord.





# > ROOF MOUNTED EQUIPMENT

## Building Three Special Requirements

- Slab must be scanned prior to any core drilling to ensure compliance with coring guidelines.
- Tenants must hire the structural engineer to review or create all details for core drilling through the slab in Building 3.
- Tenant may use existing block-outs in precast double tee stems for pipes or conduit running north-south, if space is available.
- No new penetrations are allowed through precast double tee stems.
- Floor penetrations through topping slab and precast double tee flanges are permitted as shown on the attached plan and section sketches. Not more than four (4) penetrations are allowed within any 4'-0" x 4'-0" area. Not more than 6 penetrations are allowed in line. Tenant shall scan floor slabs for rebar and mesh, and shall not core through any rebar or mesh. Drilled holes shall be made using a non-rebar eating tip.
- Floor penetrations through precast hollow core plank are permitted as shown on the attached plan and section sketches. Not more than 4 penetrations are allowed within any 4'-0" x 4'-0" area. Not more than 6 penetrations are allowed in line. Tenant shall scan floor slabs for rebar and mesh. Drilled holes shall be made using a non-rebar eating tip.
- No new penetrations are allowed through precast girders.
- Abandoned holes shall be filled with high-strength, non-shrink, non-metallic grout.
- No new slab penetrations are allowed within the highlighted zones on the attached plan sketches (see pages 32-33).
- If reinforcing steel is hit with a non-rebar eating tip, the hole shall be abandoned and patched with high-strength, non-shrink, non-metallic grout.
- Tenant shall submit proposed penetration locations to the Landlord's required structural engineer at Tenant's expense, for review and approval prior to performing work.

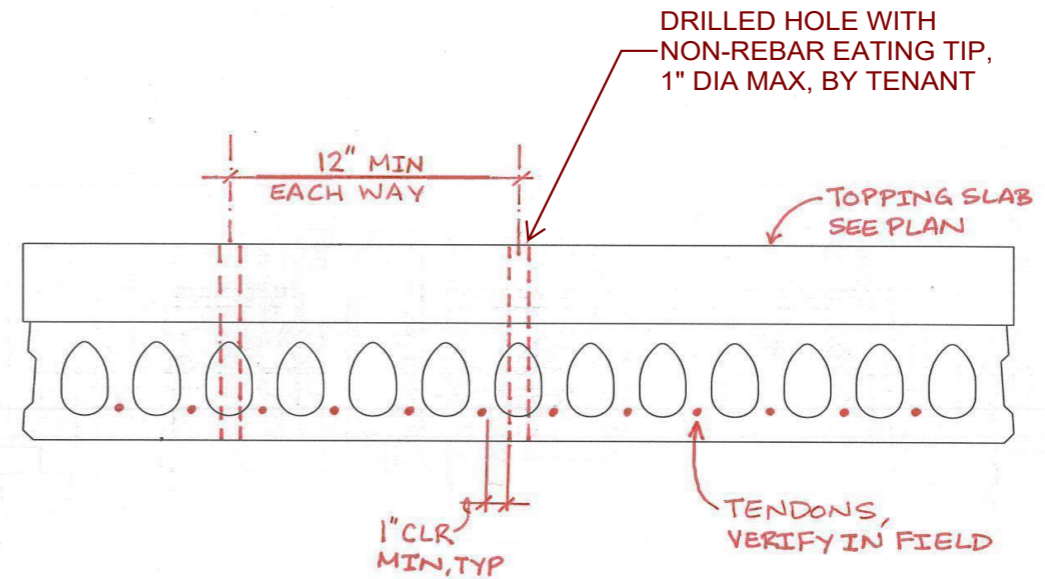

**NOTE:** DO NOT DAMAGE TOPPING SLAB REINFORCING. CONTRACTOR TO LOCATE REINFORCING & TENDONS PRIOR TO DRILLING

Slab must be scanned prior to any core drilling to ensure compliance with coring guidelines.

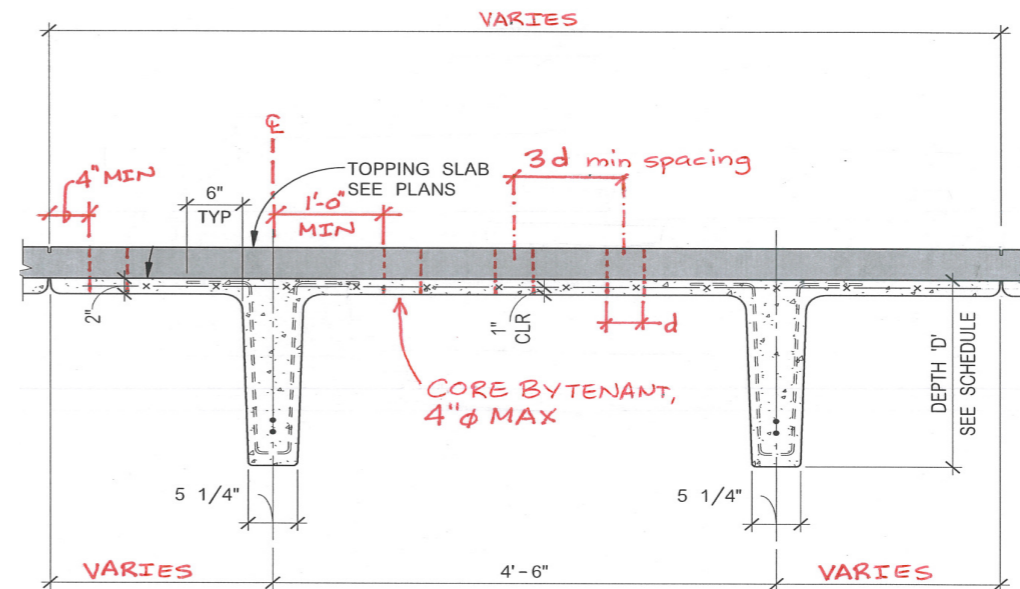

**NOTE:** DO NOT DAMAGE TOPPING SLAB REINFORCING. CONTRACTOR TO LOCATE REINFORCING PRIOR TO CORE DRILLING. NOT TO EXCEED 4 CORES IN ANY 4'-0" x 4'-0" AREA.

Slab must be scanned prior to any core drilling to ensure compliance with coring guidelines.

# > STRUCTURAL

## DESIGN REQUIREMENTS

- **SELF SUPPORTED STOREFRONTS** are required. Tenant may not support the storefront from the bulkhead, fascia, or roof deck. Structural lateral bracing support for Tenant storefronts must be from the roof joists.
- **ROOF DECK ATTACHMENT OR USE AS SUPPORT** for fixtures and equipment is not permitted.
- **HEAVY ITEMS** require structural drawings if weighing 300 lbs. or more.
- **JOIST REINFORCING** is required for roof top equipment as well as steel support for all roof openings.

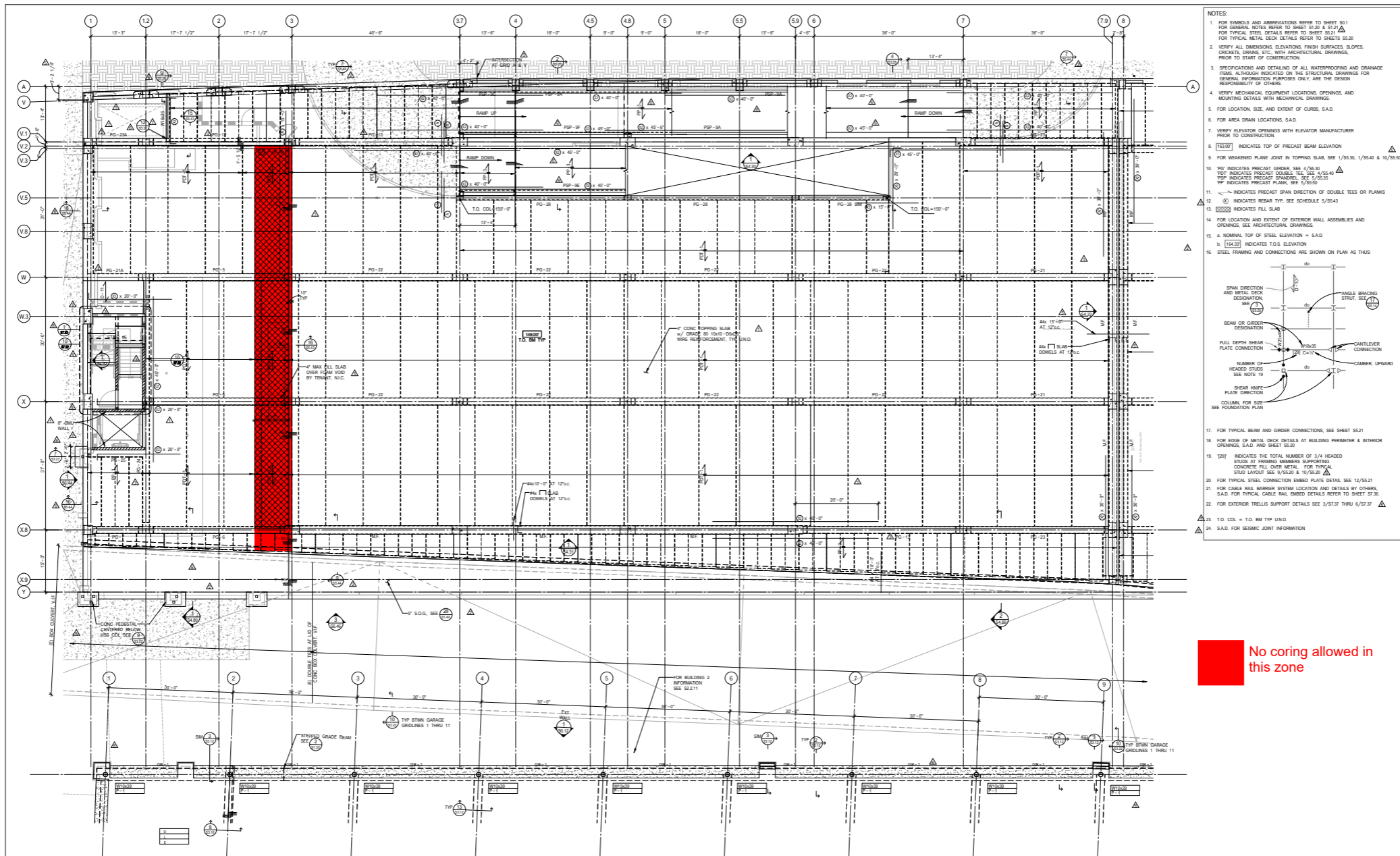

**No coring allowed in this zone**





- NOTES:**
1. FOR SYMBOLS AND ABBREVIATIONS REFER TO SHEET 50.1 FOR GENERAL NOTES REFER TO SHEET 51.20 & 51.21 FOR TYPICAL STEEL DETAILS REFER TO SHEET 55.21
  2. VERIFY ALL DIMENSIONS, ELEVATIONS, FINISH SURFACES, SLOPES, CONCRETE, DRAINS, ETC. WITH ARCHITECTURAL DRAWINGS PRIOR TO START OF CONSTRUCTION.
  3. SPECIFICATIONS AND DETAILING OF ALL WATERPROOFING AND DRAINAGE ITEMS, ALTHOUGH INDICATED ON THE STRUCTURAL DRAWINGS FOR GENERAL INFORMATION PURPOSES ONLY, ARE THE DESIGN RESPONSIBILITY OF OTHERS.
  4. VERIFY MECHANICAL EQUIPMENT LOCATIONS, OPENINGS, AND MOUNTING DETAILS WITH MECHANICAL DRAWINGS.
  5. FOR LOCATION, SIZE, AND EXTENT OF CURBS, S.A.D.
  6. FOR AREA DRAIN LOCATIONS, S.A.D.
  7. VERIFY ELEVATOR OPENINGS WITH ELEVATOR MANUFACTURER PRIOR TO CONSTRUCTION.
  8.  $\Delta$  INDICATES TOP OF PRECAST BEAM ELEVATION
  9. FOR WEAKENED PLANE JOINT IN TOPPING SLAB, SEE 1/55.30, 1/55.40 & 10/55.50
  10.  $\nabla$  INDICATES PRECAST GIRDER, SEE 4/55.30
  11.  $\nabla$  INDICATES PRECAST DOUBLE TEE, SEE 4/55.40
  12.  $\nabla$  INDICATES PRECAST SPANDREL, SEE 5/55.35
  13.  $\nabla$  INDICATES PRECAST PLANK, SEE 5/55.35
  11.  $\nabla$  INDICATES PRECAST SPAN DIRECTION OF DOUBLE TEES OR PLANKS
  12.  $\nabla$  INDICATES REBAR TYP. SEE SCHEDULE 5/55.43
  13.  $\nabla$  INDICATES FILL SLAB
  14. FOR LOCATION AND EXTENT OF EXTERIOR WALL ASSEMBLIES AND OPENINGS, SEE ARCHITECTURAL DRAWINGS.
  15. a. NOMINAL TOP OF STEEL ELEVATION = S.A.D.  
b.  $\Delta$  INDICATES T.O.S. ELEVATION
  16. STEEL FRAMING AND CONNECTIONS ARE SHOWN ON PLAN AS THIS:
    - SPAN DIRECTION AND METAL DECK DESIGNATION (SEE 1/55.30)
    - ANGLE BRACING STRUT, SEE 1/55.30
    - BEAM OR GIRDER DESIGNATION
    - FULL DEPTH SHEAR PLATE CONNECTION
    - CANTILEVER CONNECTION
    - NUMBER OF HEADED STUDS (SEE NOTE 19)
    - CAMBER UPWARD
    - SHEAR KNIFE PLATE CONNECTION
    - COLUMN, FOR SIZE SEE FOUNDATION PLAN
  17. FOR TYPICAL BEAM AND GIRDER CONNECTIONS, SEE SHEET 55.21
  18. FOR EDGE OF METAL DECK DETAILS AT BUILDING PERIMETER & INTERIOR OPENINGS, S.A.D. AND SHEET 55.20
  19.  $\nabla$  INDICATES THE TOTAL NUMBER OF 3/4" HEADED STUDS AT FRAMING MEMBERS SUPPORTING CONCRETE FILL OVER METAL. FOR TYPICAL STUD LAYOUT SEE 9/55.20 & 10/55.21
  20. FOR TYPICAL STEEL CONNECTION EMBED PLATE DETAIL, SEE 12/55.21
  21. FOR CABLE RAIL BARRIER SYSTEM LOCATION AND DETAILS BY OTHERS, S.A.D. FOR TYPICAL CABLE RAIL EMBED DETAILS REFER TO SHEET 57.36
  22. FOR EXTERIOR TRELLIS SUPPORT DETAILS SEE 3/57.37 THRU 6/57.37
  23. T.O. COL. = T.O. BM TYP. UNO.
  24. S.A.D. FOR SEISMIC JOINT INFORMATION

**No coring allowed in this zone**

GARAGE C - LEVEL 1 FRAMING PLAN - C2

SCALE: 1/8" = 1'-0" 1



## > SEISMIC JOINT DETAILS

### GARAGE C / BUILDING 3 TENANT DECK ATTACHMENT GUIDELINES

Tenant may attach to bottom of precast double tees, precast plank, or precast beams provided the following criteria are maintained.

- Tenant may attached to precast double tee stems with low velocity pins or concrete screw anchors with 1 3/8" MAX embedment. Do not damage prestressing tendons at double tee stems.
- Tenant may attached to double tee flanges with 3" MIN embedment, 4" MAX embedment. Attachment may not be within 6" from edge of double tee flange.
- Attachment to precast plank is acceptable using HILTI KH-EZ screws with 1 5/8" embed into hollow cells. Per HILTI tests results, there is no reduction of capacity for these anchors. HILTI concrete screw anchors to be installed per manufacturer recommendations. Do not damage prestressing tendons at plank webs.
- Tenant may attach to precast beams and spandrels with low velocity pins or concrete screw anchors with 1 3/8" MAX embedment. Do not damage prestressing tendons at precast beams.
- All pre-drilled holes shall be made using non-rebar eating drill bit. If reinforcing is hit, the hole shall be abandoned and patched with high-strength, non-shrink, non-metallic grout.
- Tenant ceilings shall weigh a maximum of 10 psf. Tenant to submit heavier systems and point loads to KPFF for review.
- Tenant shall submit proposed attachment details to KPFF for review and approval prior to performing work.

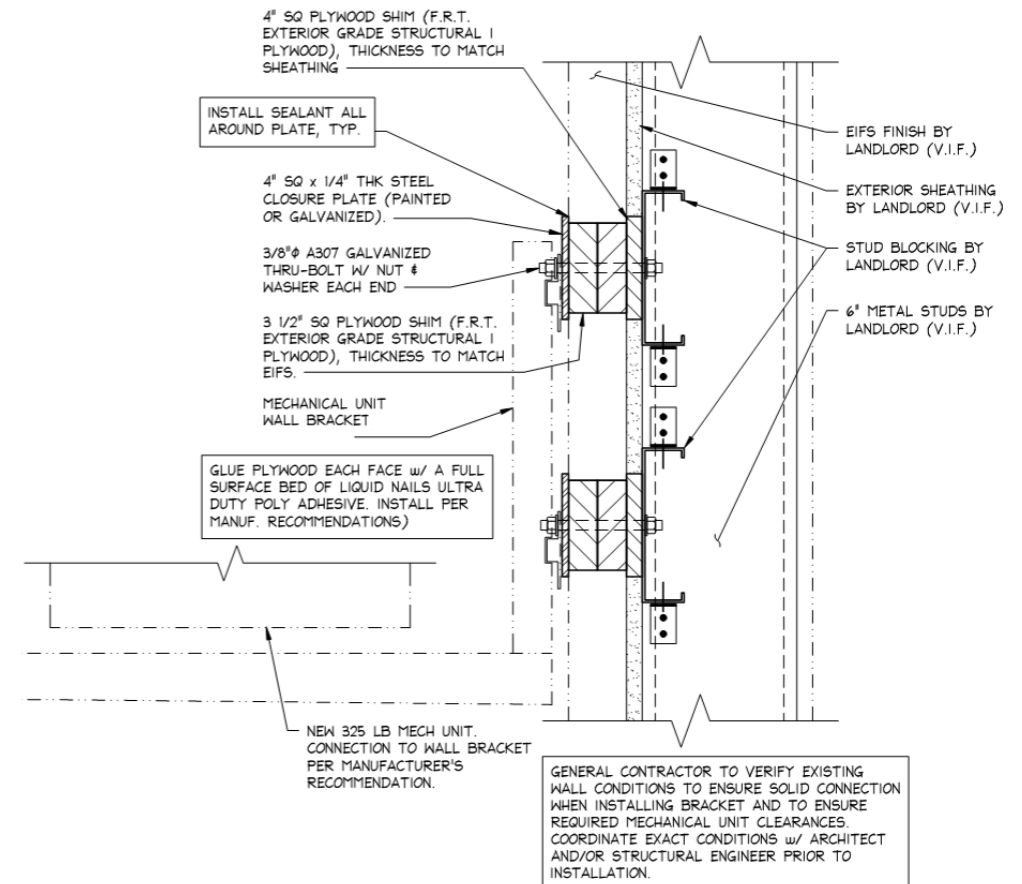

Minimum head clearance of 6'-8" is required from floor to lowest point of RTU bracket assembly.

Landlord recommends wall bracket model QUICK-SLING QSWB2000

<http://www.quick-sling.com/#lqswb2000/c1hvg>

You will need to drill a new hole below the top hole of the bracket to raise it high enough to get the required head clearance.

To conceal and exposed conduits or refrigerant lines on the outside wall of the building you need to use the Slimduct professional duct/fitting system in the brown color.

[Slimduct®Heavydutyprofessionalgradeductandfittings.-RectorSeal](#)

### BUILDING 3 / GARAGE C WALL MOUNT RTU BRACKET



# FOOD CRITERIA CONTENT OVERVIEW

## 2.1

### RESTAURANTS

DETAILS SPECIFIC DESIGN, SIGNAGE, AND TECHNICAL REQUIREMENTS FOR FOOD TENANTS WITH INTERIOR OR EXTERIOR FACING RESTAURANT SERVICE.

#### SECTIONS OF INTEREST

- INLINE CRITERIA**  
Standard design, technical, and sign requirements in addition to the contents in this section.
- DESIGN INSPIRATION**  
Provides visual design inspirations for visual aesthetics.
- BUILDING DETAILS**  
Includes property reference photos and specific storefront design details.
- PROPERTY INFO**  
Includes information on the Property's building codes, area permitting, and required contractors.
- SUBMITTALS**  
Outlines requirements on how and what to compile for submittals to the Landlord for design reviews.

**This Food Tenant Criteria is specifically tailored to highlight unique technical and design requirements for Tenant's cooking, preparing, and selling food products.**

Through the application of the Criteria guidelines, Food Tenants will produce distinctly original designs unique to their brand and the Center. These guidelines are to help maintain a consistent design quality while still allowing each Tenant to achieve a high level of expression and diversity.

The goal is to enhance the shopping experience for our Customer through the quality and artfulness of Tenant design.

This Criteria will often point to the Inline Retail Criteria as several requirements and design concepts are shared.

The Tenant's Architect is encouraged to contact the Landlord's Tenant Coordinator to discuss any specific design intentions prior to commencing design work. The Tenant

Coordinator will strive to resolve all outstanding design issues. However, the Tenant

Coordinator may, in the best interest of the Center, reject any aspect of the Tenant's design.

If an acceptable design cannot be agreed upon, the Landlord may, at the Tenant's expense, provide an additional concept storefront design for consideration.



## > CONTENTS

- ❑ DESIGN
  - ❑ STOREFRONT / PREPARATION AS THEATER
  - ❑ CONTROL AREAS / SEATING
  - ❑ EXTERIOR
- ❑ SIGNAGE
  - ❑ STOREFRONT / MENU BOARDS
- ❑ TECHNICAL

### SECTIONS OF INTEREST

- ❑ *INLINE CRITERIA*  
Includes standard design, technical, and sign requirements in addition to the contents in this section.
- ❑ *DESIGN INSPIRATION*  
Provides visual design inspirations for visual aesthetics.
- ❑ *BUILDING DETAILS*  
Includes property reference photos and specific storefront design details.
- ❑ *PROPERTY INFO*  
Includes information on the Property's building codes, area permitting, and required contractors.
- ❑ *SUBMITTALS*  
Outlines requirements on how and what to compile for submittals to the Landlord for design reviews.

**The Restaurant Criteria provides key technical information and design requirements to ensure your interior or exterior facing restaurant food service enlivens the consumer experience and interfaces with the Center.**

This criteria will often point to the Inline Retail Criteria as several requirements and design concepts are shared. The content in this section highlights the unique concepts for food service design.

The tenant and the tenant's architect assume the following important obligations:

- Fulfill the intent of the criteria both in concept and in detail.
- Determine and respond to the actual physical conditions of the Tenant's location (Zone requirements)
- Maintain and enhance the high standards of quality established in the construction of the center.
- Ensure the quality of execution of all design material, finish, and detail concepts in the construction of the Tenant's improvement.
- Provide the required detail at all transitions from Tenant storefront to neighboring storefronts, as well as to the base building.





## > DESIGN > STOREFRONT / PREPARATION AS THEATER

Restaurant Food Tenants must adhere to the design requirements found in the Inline Design section linked here: [DESIGN CRITERIA](#)

In addition to the requirements detailed in the Design Criteria, Tenants serving food in their space must adhere to the following design requirements:

### **GENERAL STOREFRONT AND DESIGN**

Restaurant storefronts will be subject to the general storefront criteria in this manual, for both design and technical requirements.

Restaurants may face both the interior and the exterior, and are often located adjacent to a mall entry. The exterior and the interior are subject to different criteria standards, both for presentation and signage.

Interior restaurants oftentimes have a waiting area within the common space.

- If needed these must be shown in the submissions and be approved by Landlord. They must be coordinated with common area needs and code requirements.

We encourage a cohesive presentation of the brand within the context of the whole mall design, while the individual brand is important and the two must harmonize. Design should be tailored to its location both within the community and the whole Center's aesthetics.

### **PREPARATION AS THEATER**

Tenant's offering a peek into the making of food, by nature, include the customer and make for an authentic experience. This inclusion of the customer will increase engagement and is highly encouraged.



## > CONTROL AREAS / SEATING

### CONTROL AREAS

The DCA is the area at the front of the Tenant space that extends from the Lease Line to all points 6'-0" to 8'-0" into the space. It should convey excitement and give the consumer a reason to engage.

Exposed patios are encouraged however, they should not extend beyond the lease line. In special cases there may be opportunity to extend the patio but it must be in compliance with all common mall code and circulation requirements.

Projection or canopies may increase the visibility of the storefront over seating areas. They also help with lighting the storefront.

In addition to the general DCA criteria for inline stores the following requirements must be met:

- All patio rails, reception podiums, waiting areas, menu presentations, lighting, heating, visible banquet detailing, and material palettes must be presented for review and approval.
- Common mall flooring must be maintained. Coordinate with Landlord design if railings or other elements will have an effect on the flooring.

### SEATING

Where interior seating is needed or desired, it is suggested that the enclosure line be moved into the lease space by approximately 12 feet.

In some cases options for furniture may be supplied by the mall design team for the tenant to choose from. Refer to the Zone Plan for your location found in the linked: BUILDING DETAILS SECTION.

Seating design requirements include:

- Patio seating must be separated from the common area circulation in the Mall. A layout will be required for review.
- All visible furniture must be reviewed by the Landlord for suitability both aesthetically, as well as for performance specifications.
- Tenant is responsible to confirm additional requirements with the local authorities for any railing or barrier for the Tenant's proposed area.





## > EXTERIOR

**Restaurants with exterior storefronts will be subject to the general criteria in this manual, for aesthetics.**

Exterior design should be tailored to its location both within the community as well as the whole Mall and its aesthetics.

### SITE PLANS

- A Site Plan must be submitted that includes all required calculations for GLA, GBA, and parking requirements.
- Site Circulation must be included showing the adjacent intersections, driveways, drive directions, and dimensions of all access points.
- Photos of adjacent and onsite conditions may be required by ownership for the review process.

### AMENITIES

- Planters, heat lamps, tables, chairs etc., must be submitted for approval. All amenities must be commercial grade and suitable for outdoor use.
- Pendant or sconce lighting must be submitted for approval by Landlord.
  - Lighting plans of canopies and trellis are available in Landlord supplied base drawings.
- Umbrellas are only allowed in the designated areas and cannot overhang into the public right-of-way.
  - Umbrellas should be small in scale (maximum 6'-0" in diameter) and no more than 9'-0" high at the peak.
  - Wood or metal are the only acceptable materials for the umbrella structure. No insignia, graphics or text are permitted on the umbrella fabric.
  - The umbrella fabric must be flame retardant material in a color approved by Landlord's Tenant Coordinator.

### EXTERIOR PATIOS

- Any changes to an existing patio must be approved by Landlord. Tenant is responsible to confirm the requirements with the local municipality for proposed use.
- Temporary elements such as greeting stands, waiting areas must be submitted for review.
- Confirm code height and density of railings for of any necessary barriers.
- Patio layouts with adjacent circulation dimensioned must be included in the first submittal of documents for design review.
- Railing design details should be submitted with the concept and construction packages for approval by the Landlord design team.





## > SIGNAGE > PRIMARY / MENU BOARDS

### PRIMARY STOREFRONT SIGN

Inline and Restaurant Food Tenants must adhere to the signage requirements found in the Inline Signage section linked here: [SIGN CRITERIA](#)

Exterior signage must adhere to the requirements established by the local municipality. Specific requirements can be found in the Addendum linked here: [ADDENDUM](#)

### MENU BOARDS

Inline and Restaurant Food Tenants must adhere to the menu board requirements found in the Food Court Signage section linked here: [FOOD COURT SIGN CRITERIA](#)







## > TECHNICAL

Inline and Restaurant Food Tenants must adhere to the technical requirements found in the Inline Technical section linked here: [TECHNICAL CRITERIA](#)

In addition to the requirements detailed in the Technical Criteria, Tenants cooking food in their space must adhere to the same requirements found in the Inline Counter Service Technical section linked here: [INLINE COUNTER SERVICE TECHNICAL CRITERIA](#)



# MALL ZONES > OVERVIEW MAP

This section provides storefront design details, requirements, and visual references specific to the primary zones located within Broadway Plaza. These are additional design requirements that must be followed to ensure your store correctly interfaces with the immediate surroundings. Click or tap on a colored Zone to navigate directly to that Zone's details.

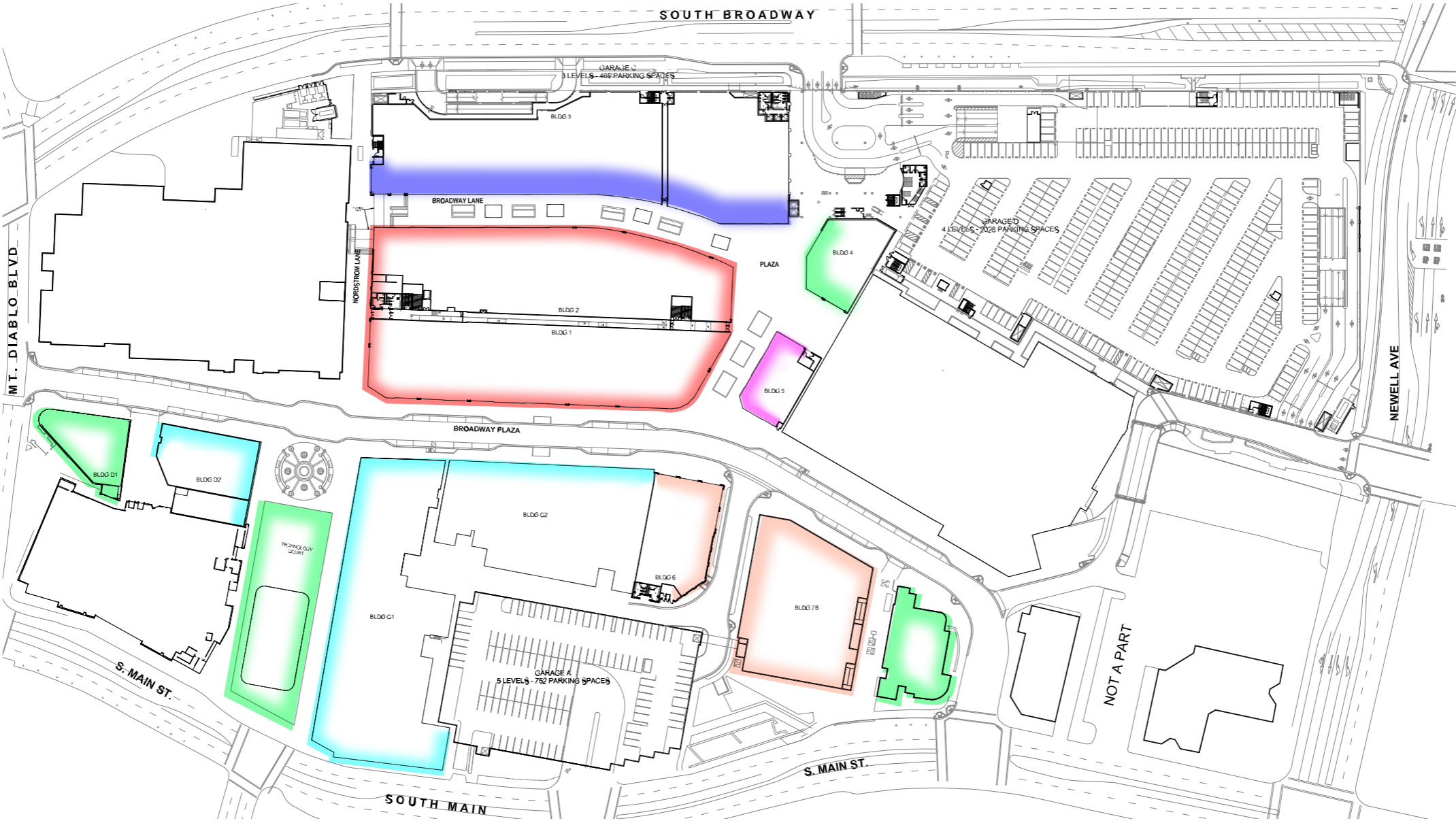

- ZONE 1  
LEVEL ONE
- ZONE 2
- ZONE 3
- ZONE 4
- ZONE 5
- ZONE 6
- ZONE 1  
LEVEL TWO



# ZONE 1 CRITERIA > LEVEL ONE TENANT

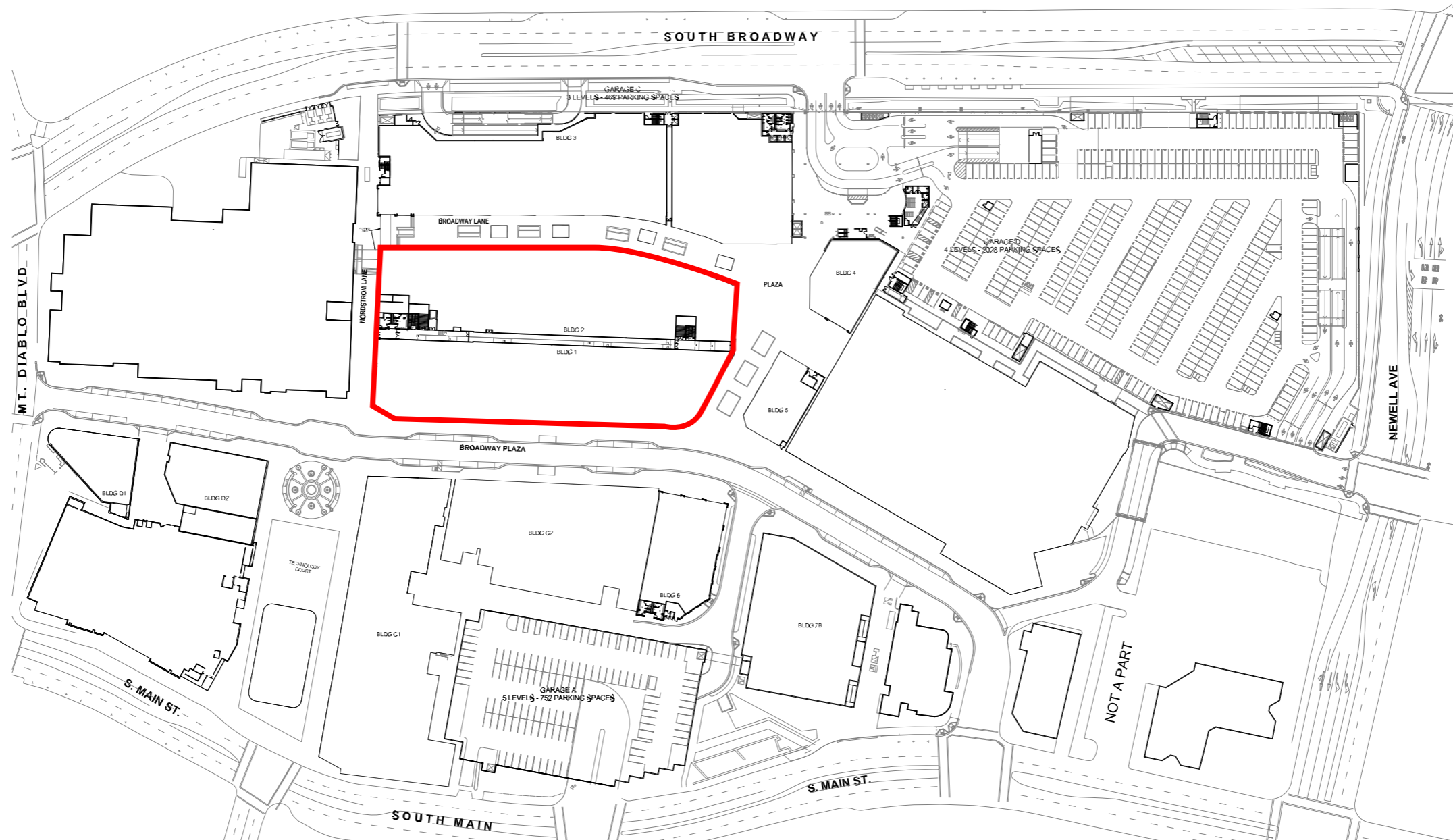

- Tenant may project storefront out up to 6" if indicated on the Landlord's LOD but in no case beyond the property line or other limits.
- When pop-out is shown on LOD a minimum of 24" on both sides of the storefront must pop-out the maximum depth.
- Where pop-out occurs, up to 70% of frontage may project to maximum pop-out depth.
- Single level Tenant storefront heights will vary from 15'-6" to 20'-6" depending on slab height at specific location.
- Storefront may also project up into the Landlord neutral band, up to a maximum of an additional 10" as shown on details C and D on page a24.

- Extent of allowable projection to be determined by Landlord, and may be subject to review by the City of Walnut Creek Design Review.
- There will be no neutral piers. Tenant storefronts will come directly into contact with one another, but cannot be on the same plane at point of connection. There must be a minimum of 3" separation from the face of one storefront to the next at the transition.
- Each Tenant storefront must independently be watertight and should be designed as if it's the first storefront. Where neighboring Tenant storefront exists, it should be treated as a neutral pier and remain undisturbed.
- Where they occur, the Landlord pilasters must remain undisturbed.



# > LEVEL ONE TENANT

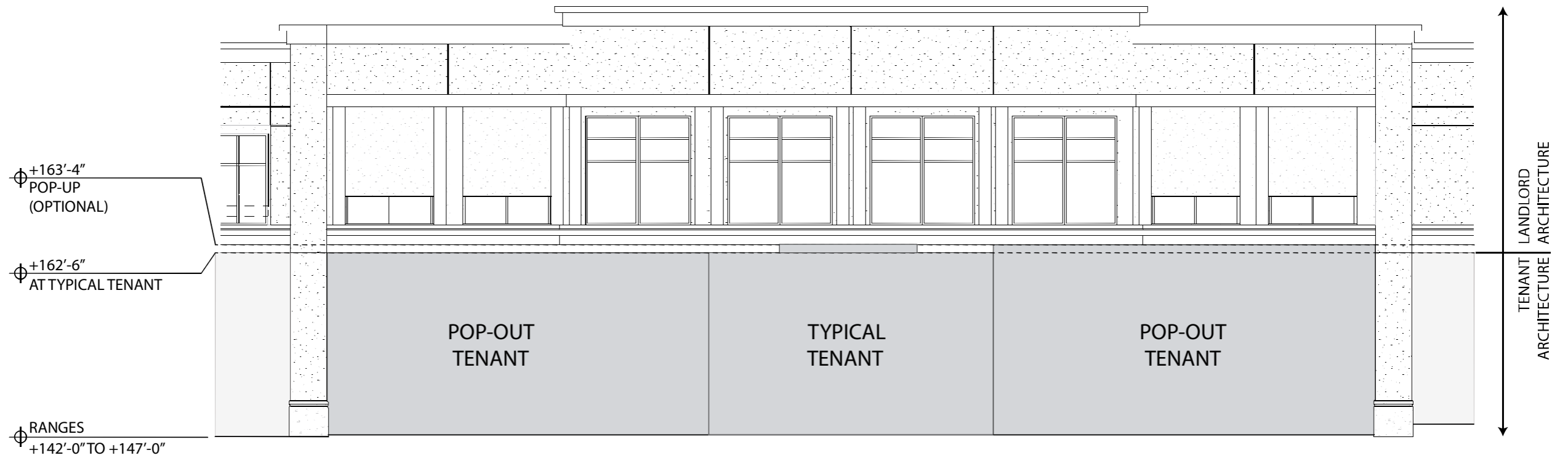

A - ELEVATION WITH ONE STORY TENANTS

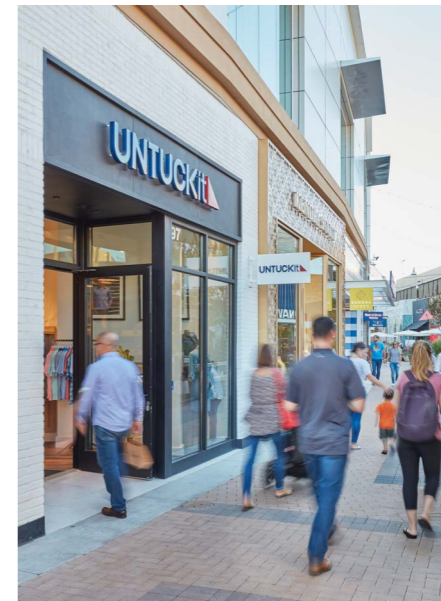

## DETAILS, PHOTOS & GRAPHICS





# > TECHNICAL DIAGRAMS > LEVEL ONE TENANT

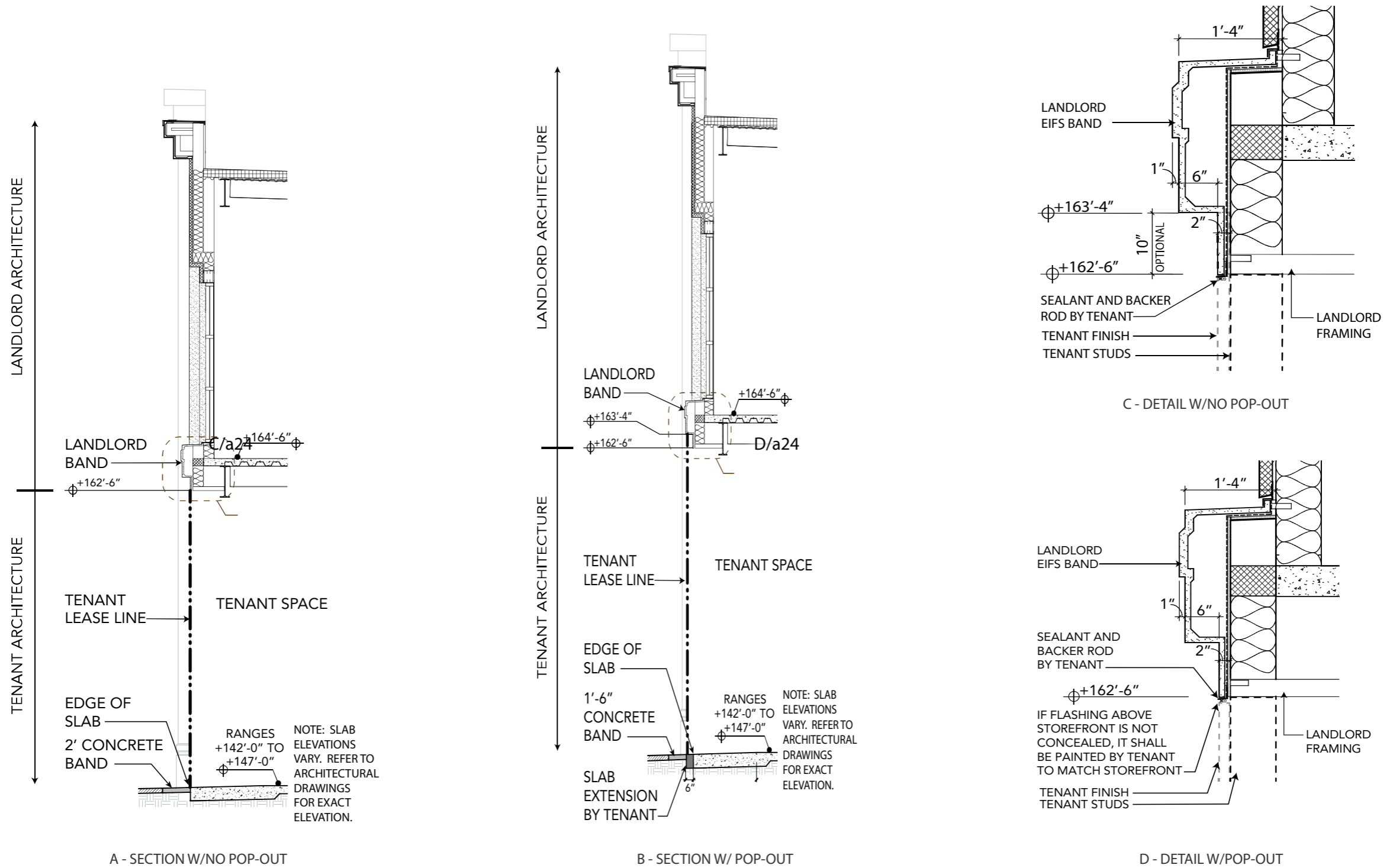

This section is representational only - see the building shell drawings for section detail specific to your location. Building 2 between grid lines 3-5 does vary from these details shown



# > TECHNICAL DIAGRAMS > ZONE 1, 2 NORTH 3, 5 REQUIREMENTS

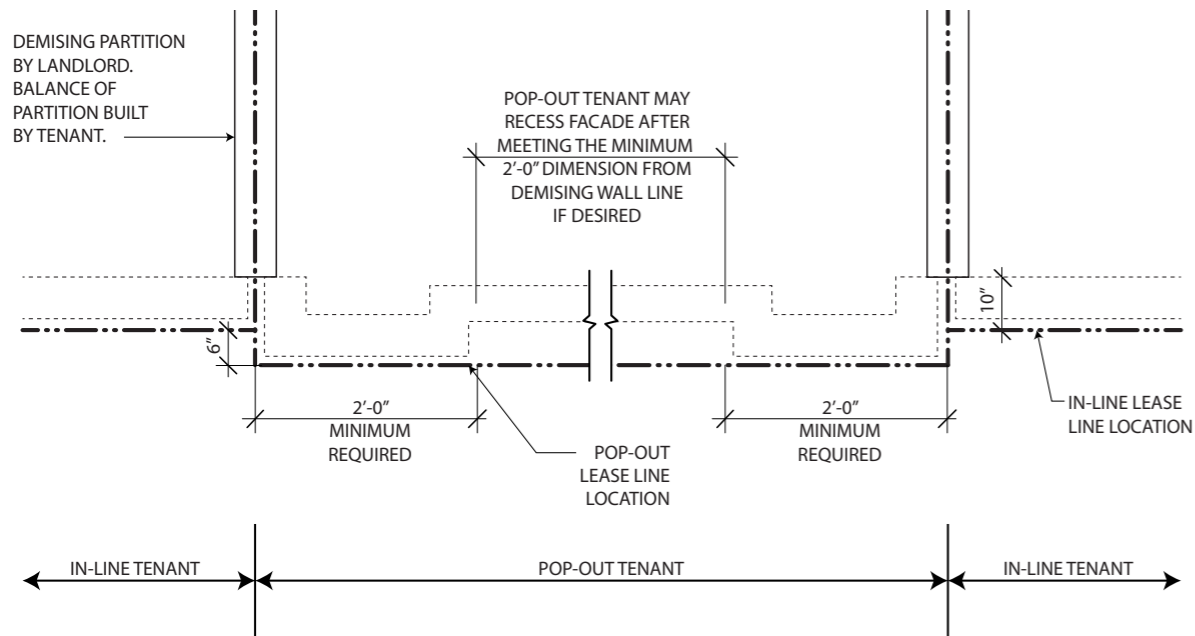

A - EXTENTS OF TENANT POP OUT

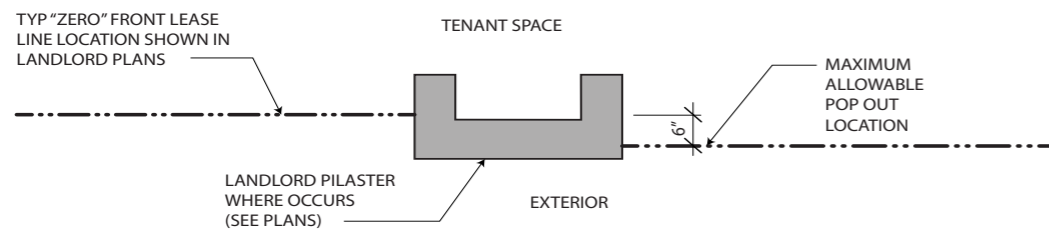

B - TENANT STOREFRONT AT LANDLORD PILASTER

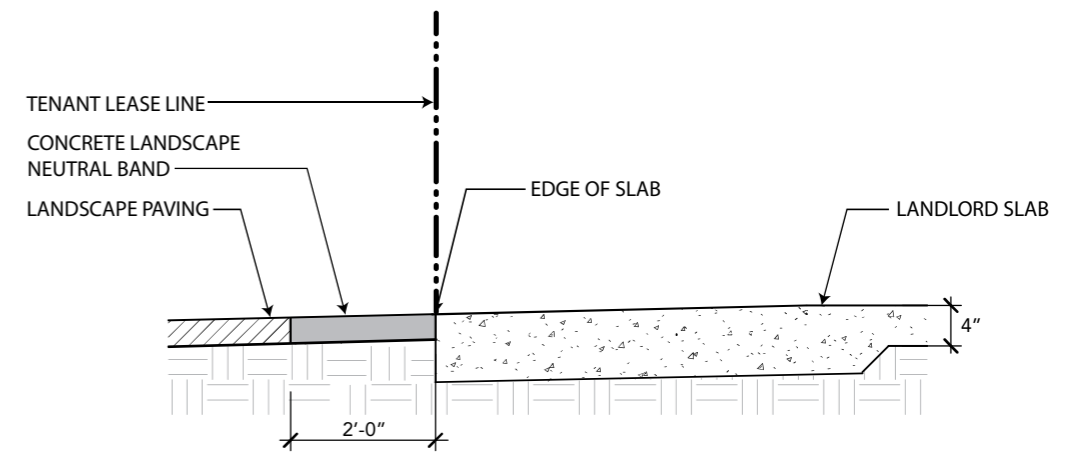

C - TENANT SLAB DETAIL AT NO POPOUT

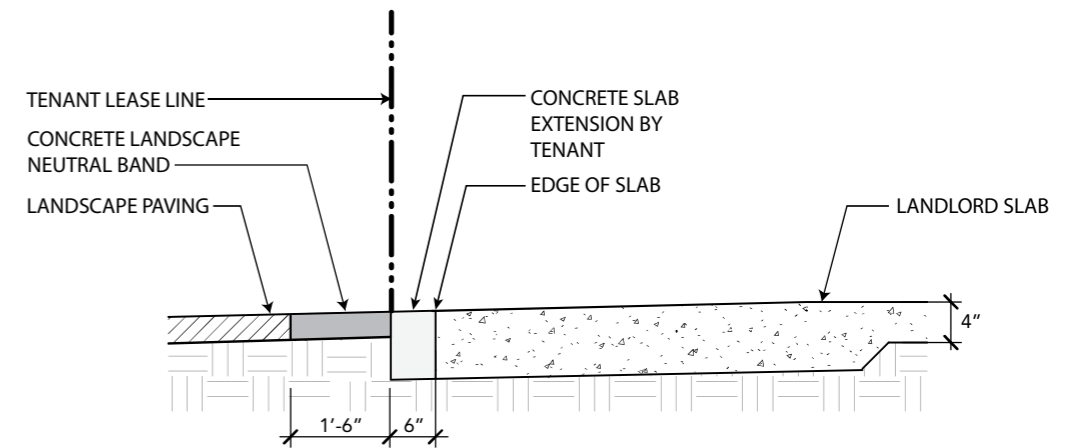

D - TENANT SLAB DETAIL AT POPOUT



# ZONE 1 CRITERIA > LEVEL TWO TENANT

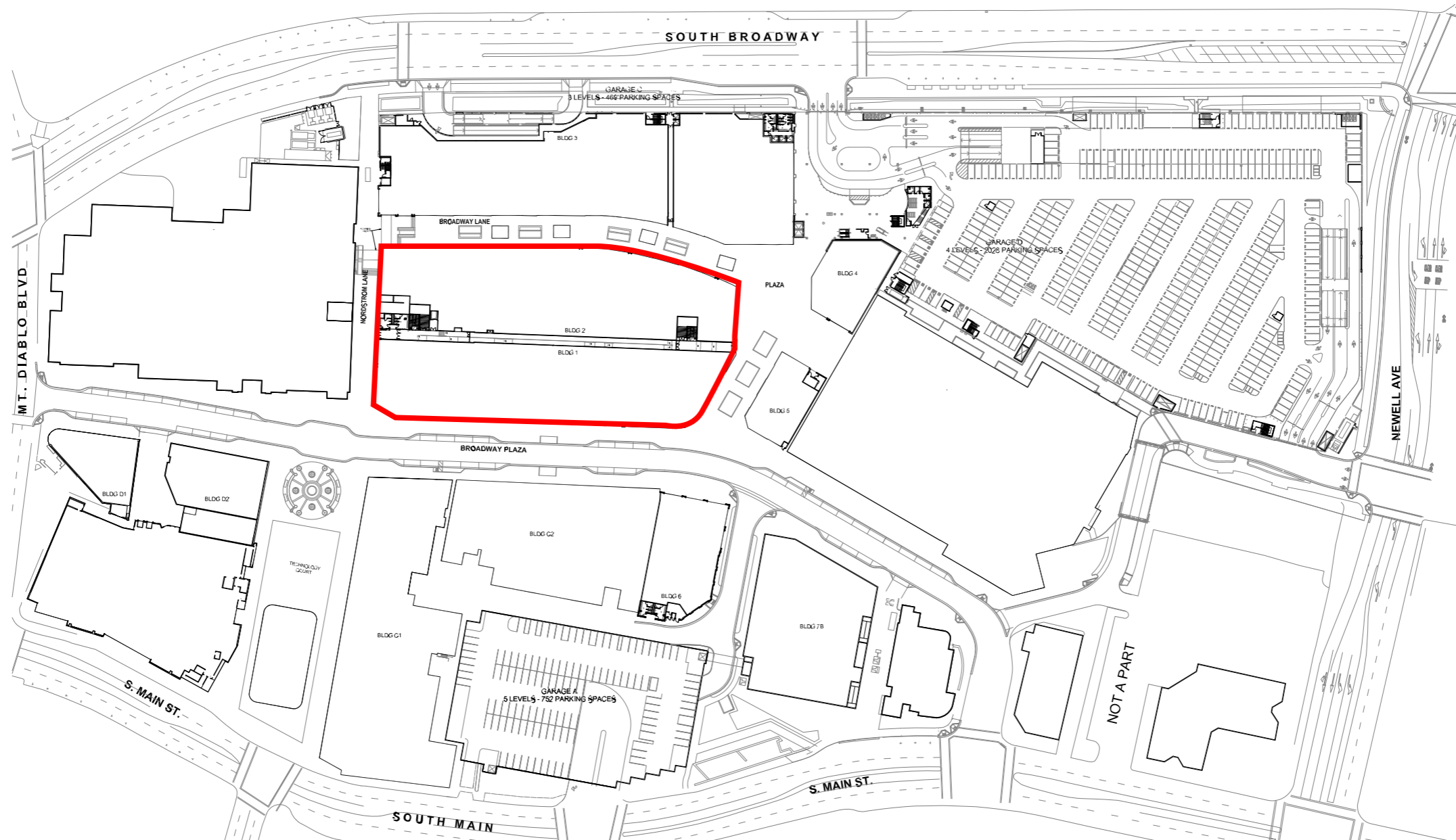

- Tenant may project storefront out up to 6" if indicated on the Landlord's LOD but in no case beyond the property line or other limits.
- When pop-out is shown on LOD a minimum of 24" on both sides of the storefront must pop-out the maximum depth.
- Where pop-out occurs, up to 70% of frontage may project to maximum pop-out depth.
- Two level Tenant storefront heights will vary from 40'-6" to 45'-6" depending on slab height at specific location.
- Extent of allowable projection to be determined by Landlord, and may be subject to review by the City of Walnut Creek Design Review.

- There will be no neutral piers. Tenant storefronts will come directly into contact with one another, but cannot be on the same plane at point of connection. There must be a minimum of 3" separation from the face of one storefront to the next at the transition.
- Each Tenant storefront must independently be watertight and should be designed as if it's the first storefront. Where neighboring Tenant storefront exists, it should be treated as a neutral pier and remain undisturbed.
- Where they occur, the Landlord pilasters must remain undisturbed.
- Tenant storefront must extend full height up to and include the parapet.
- Full storefront on both levels must be finished by Tenant including situations where the second level does not stack directly over the first level.



# > TECHNICAL DIAGRAMS > ZONE 1, 2 NORTH 3, 5 REQUIREMENTS

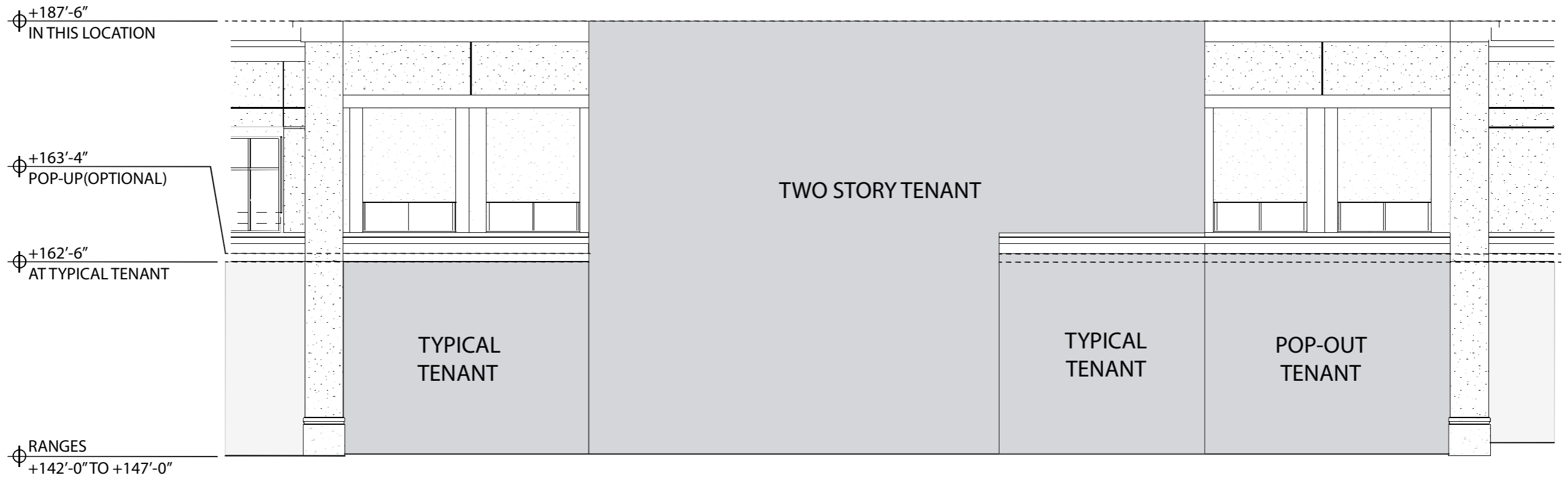

A - ELEVATION WITH TWO STORY TENANTS



## DETAILS, PHOTOS & GRAPHICS





# > LEVEL TWO TENANT

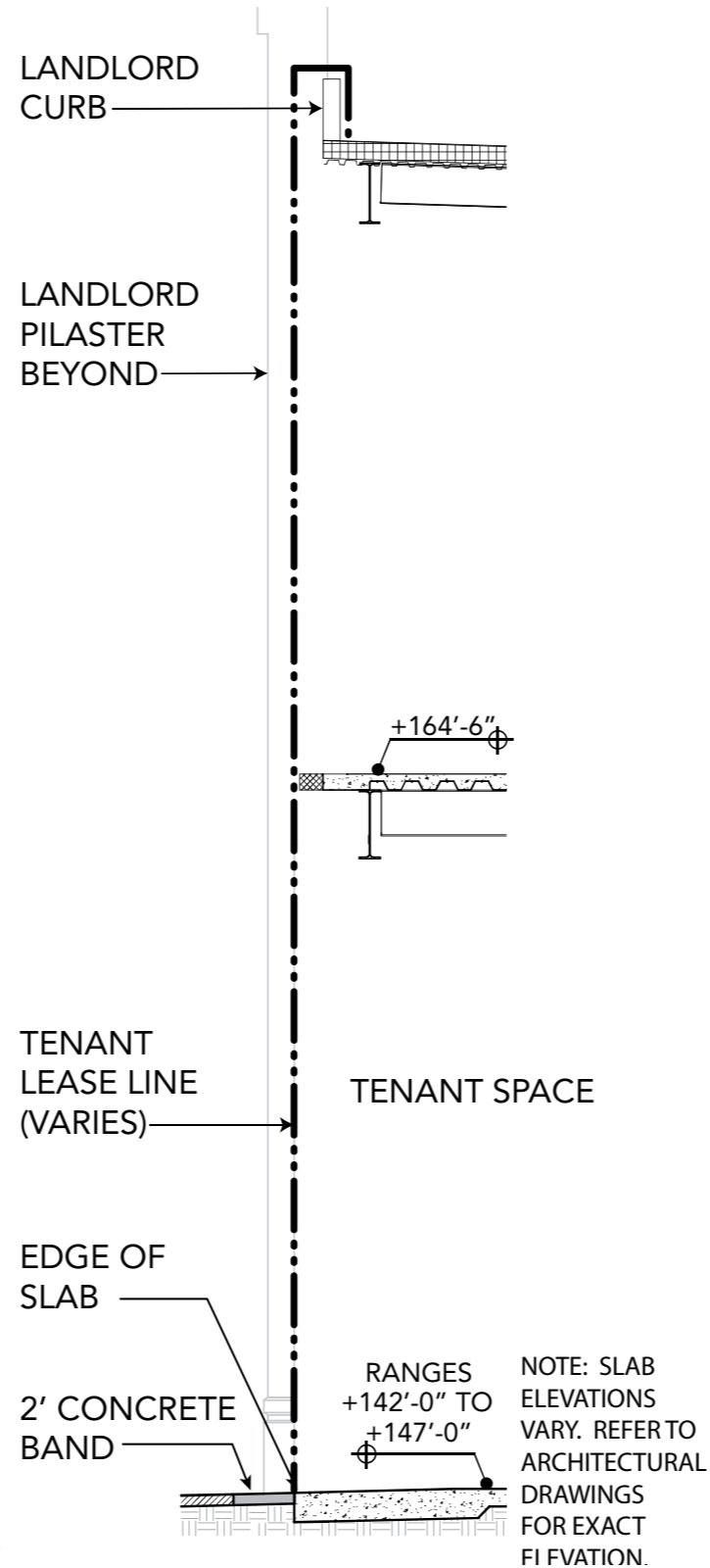

A - SECTION VIEW

This section is representational only - see the building shell drawings for section detail specific to your location. Building 2 between grid lines 3-5 does vary from these details shown



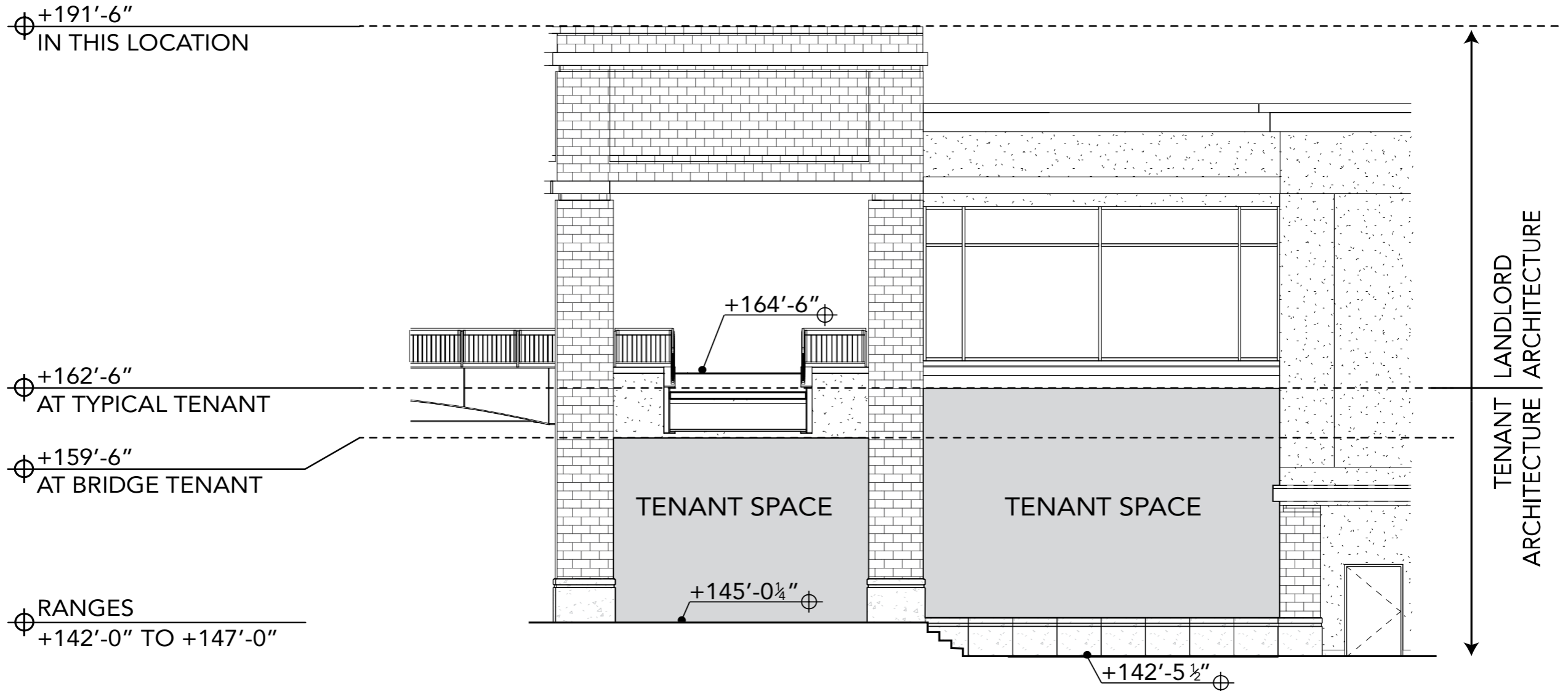

A - BLDG 1&2 - ELEVATION - BRIDGE



> SPECIAL CONDITION DIAGRAMS > UNDER PEDESTRIAN BRIDGE



A - EAST ELEVATION OF BUILDING 2 AT PEDESTRIAN BRIDGE

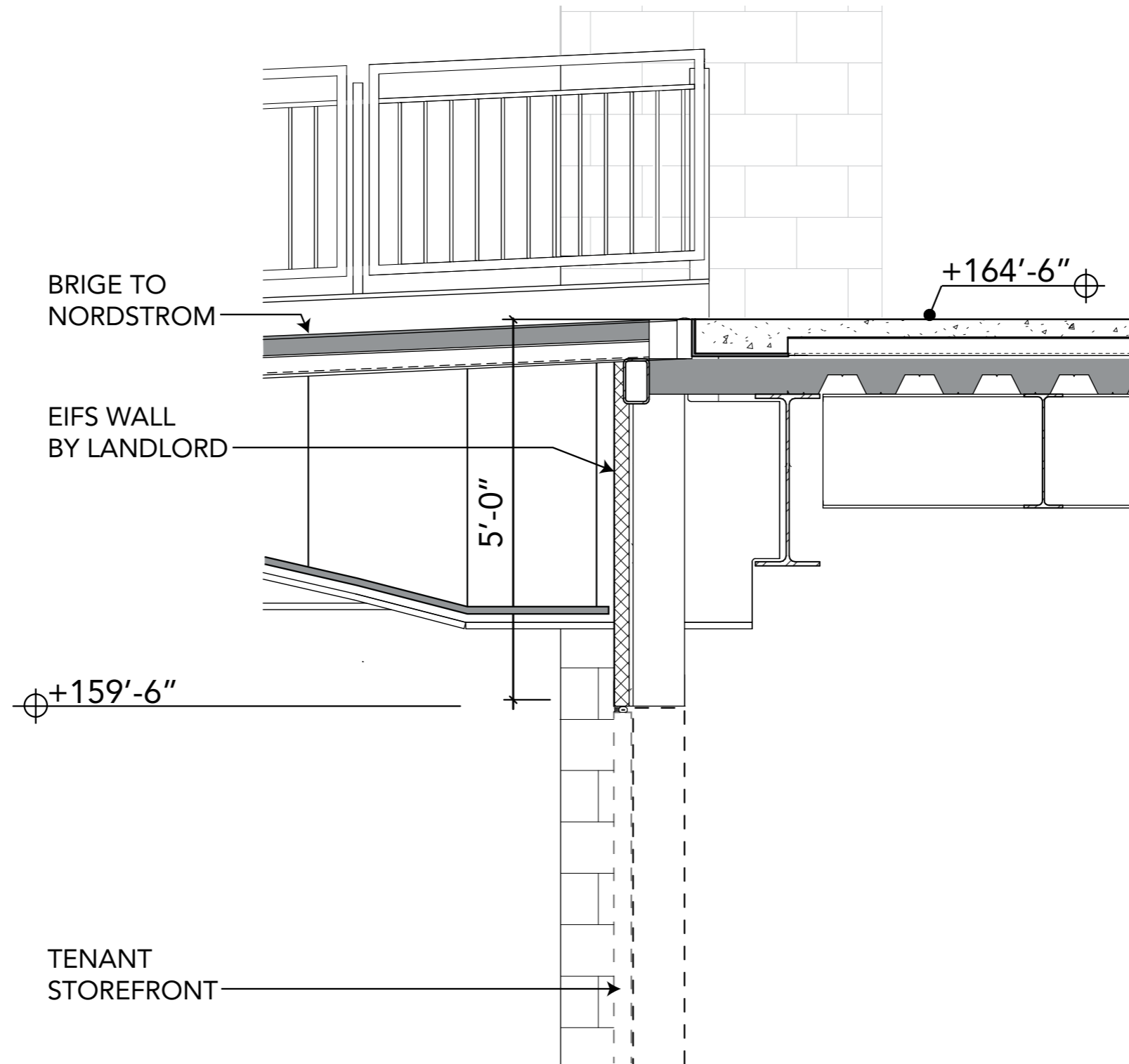

B - BLDG 1&2 - SECTION - BRIDGE

# ZONE 2 NORTH CRITERIA

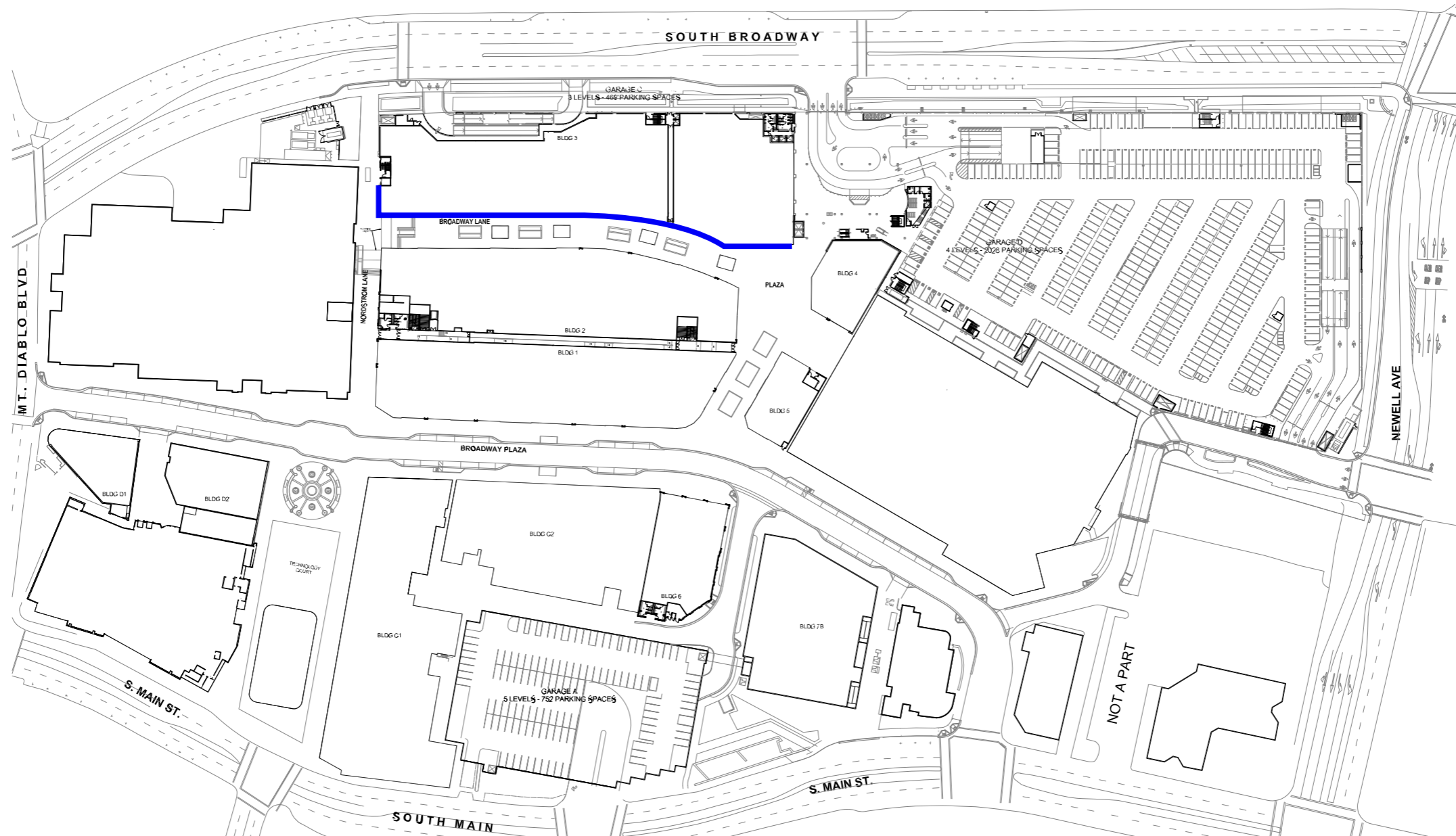

## NORTH HALF

- Tenant may project storefront out up to 6" if indicated on the Landlord's LOD but in no case beyond the property line or other limits.
- When pop-out is shown on LOD a minimum of 24" on both sides of the storefront must pop-out the maximum depth.
- Where pop-out occurs, up to 70% of frontage may project to maximum pop-out depth.
- Tenant storefront heights will vary from 20'-6" to 21'-0" depending on slab height at specific location.
- Extent of allowable projection to be determined by Landlord, and may be subject to review by the City of Walnut Creek Design Review.
- There will be no neutral piers. Tenant storefronts will come directly into contact with one another, but cannot be on the same plane at point of connection. There must be a minimum of 3" separation from the face of one storefront to the next at the transition.
- Each Tenant storefront must independently be watertight and should be designed as if it's the first storefront. Where neighboring Tenant storefront exists, it should be treated as a neutral pier and remain undisturbed.
- Where they occur, the Landlord pilasters must remain undisturbed.
- Where rear facade is exposed to the street, it must be finished as a Tenant storefront and have a display presence. See Tenant Coordinator for further details.





> TECHNICAL DIAGRAMS > ELEVATIONS

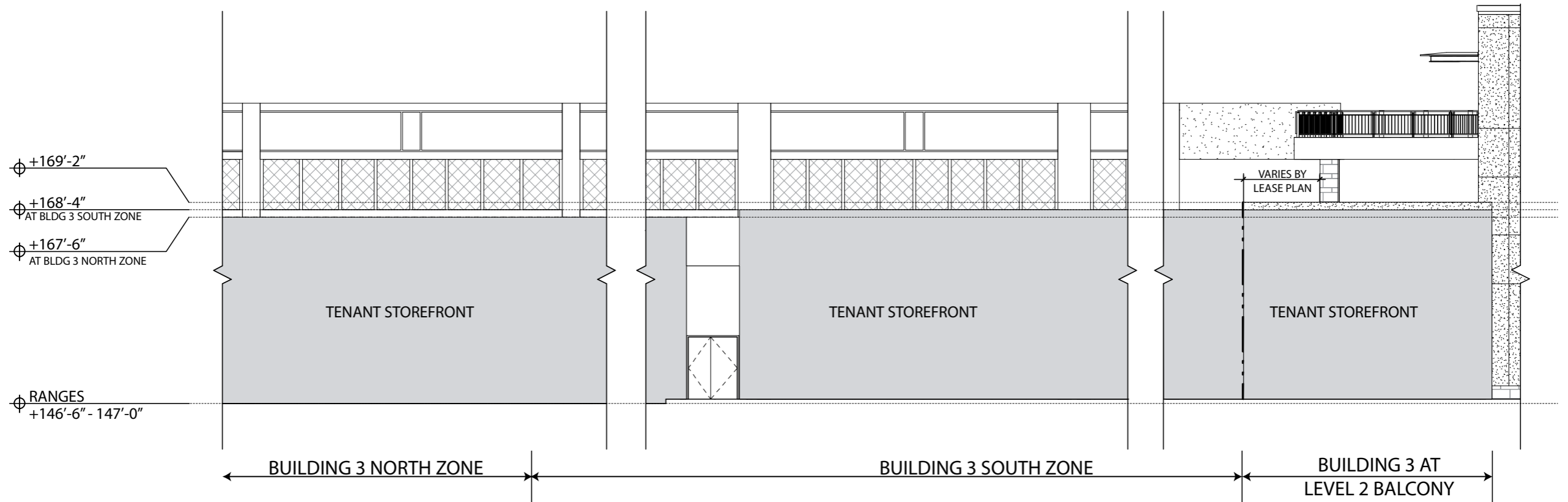

DETAILS, PHOTOS & GRAPHICS



> TECHNICAL DIAGRAMS > TENANTS UNDER BALCONY

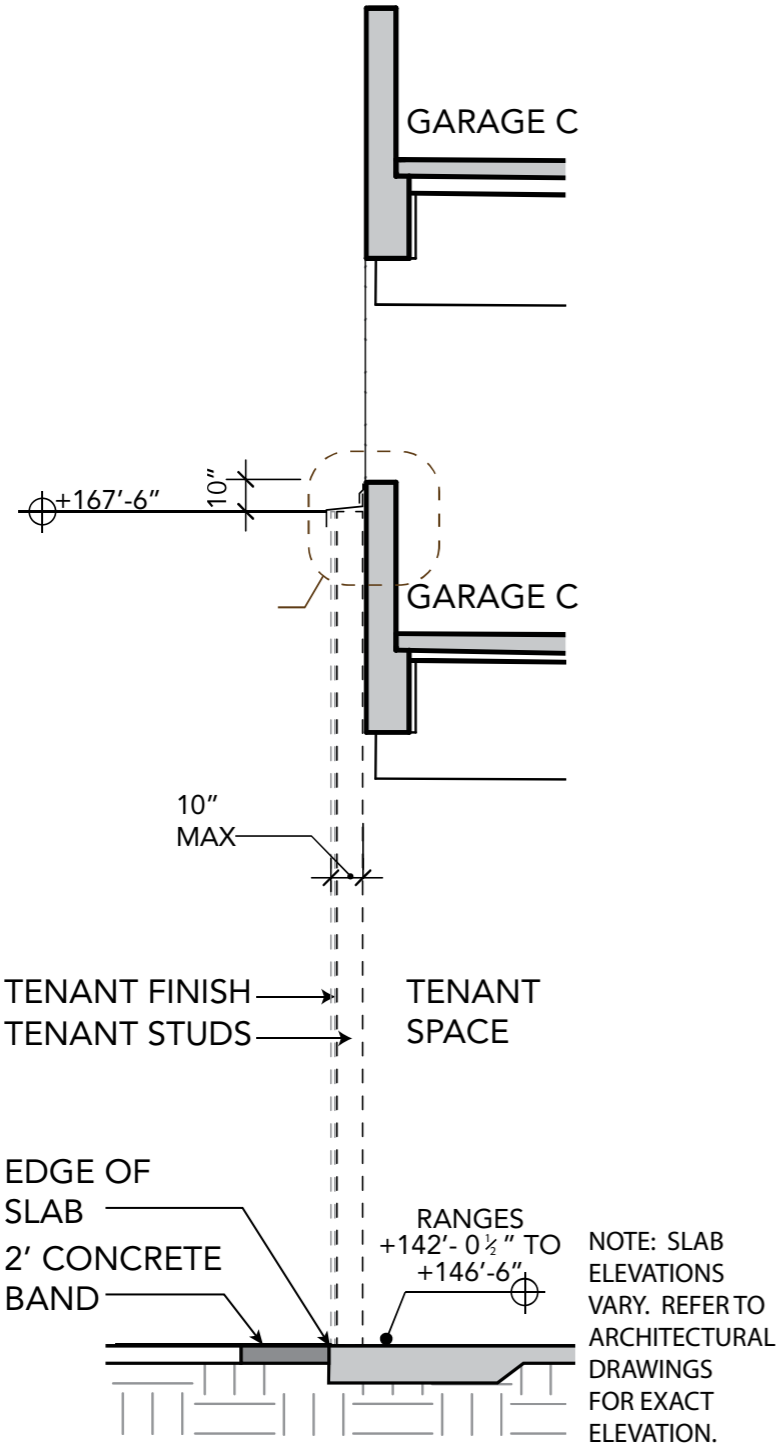

A - SECTION W/NO POP-OUT

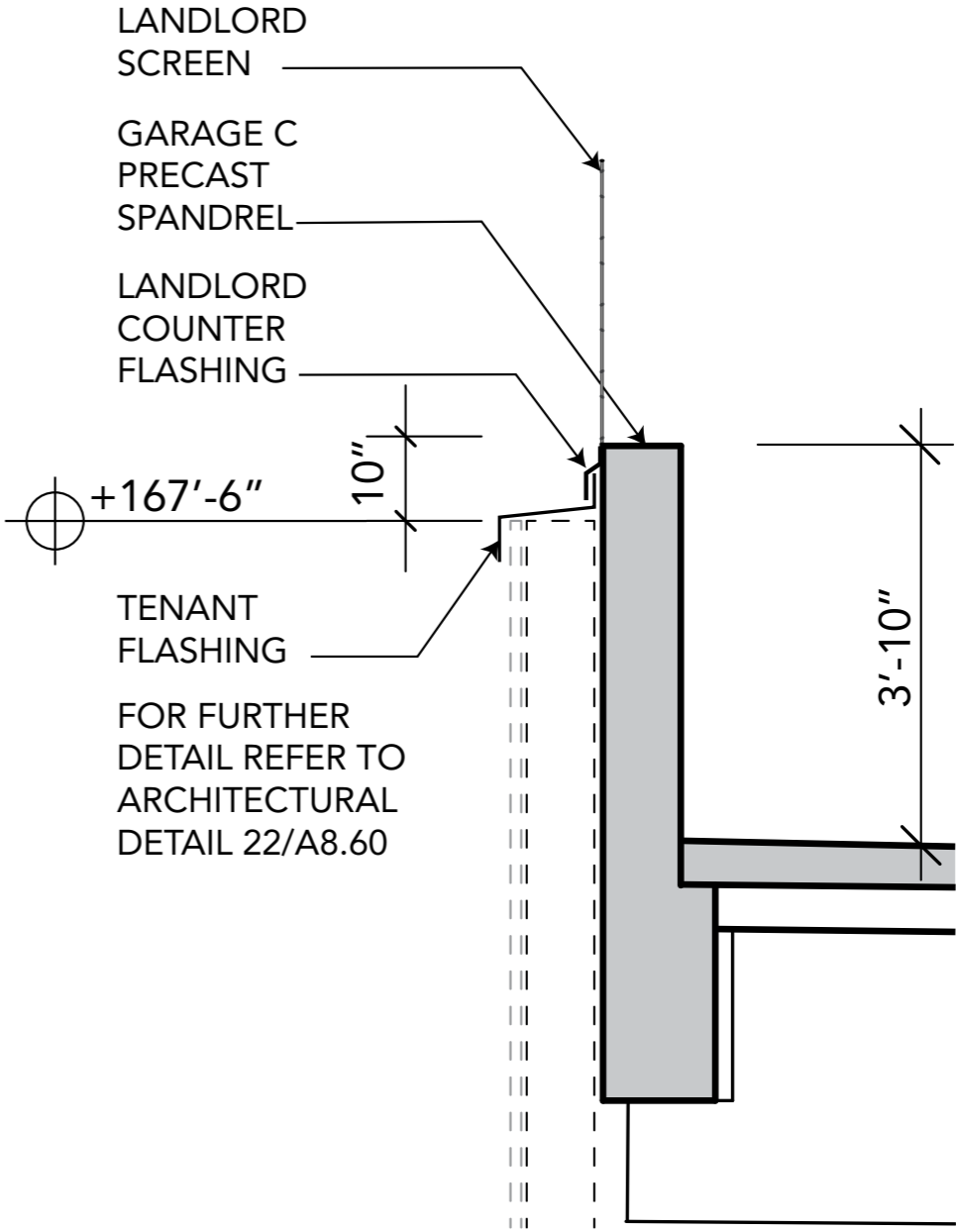

B - DETAIL AT TOP OF STOREFRONT

> TECHNICAL DIAGRAMS > TENANTS UNDER BALCONY

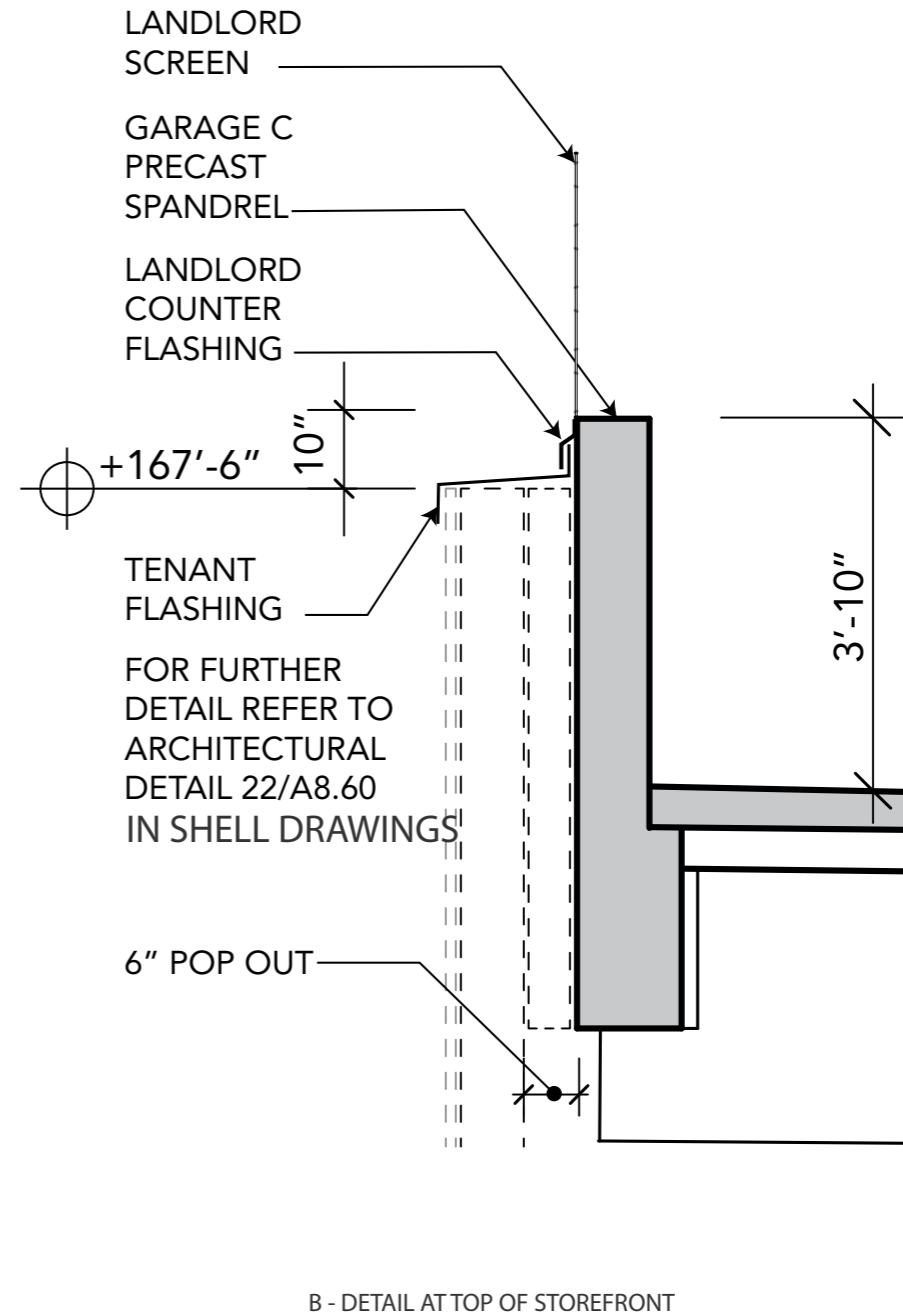
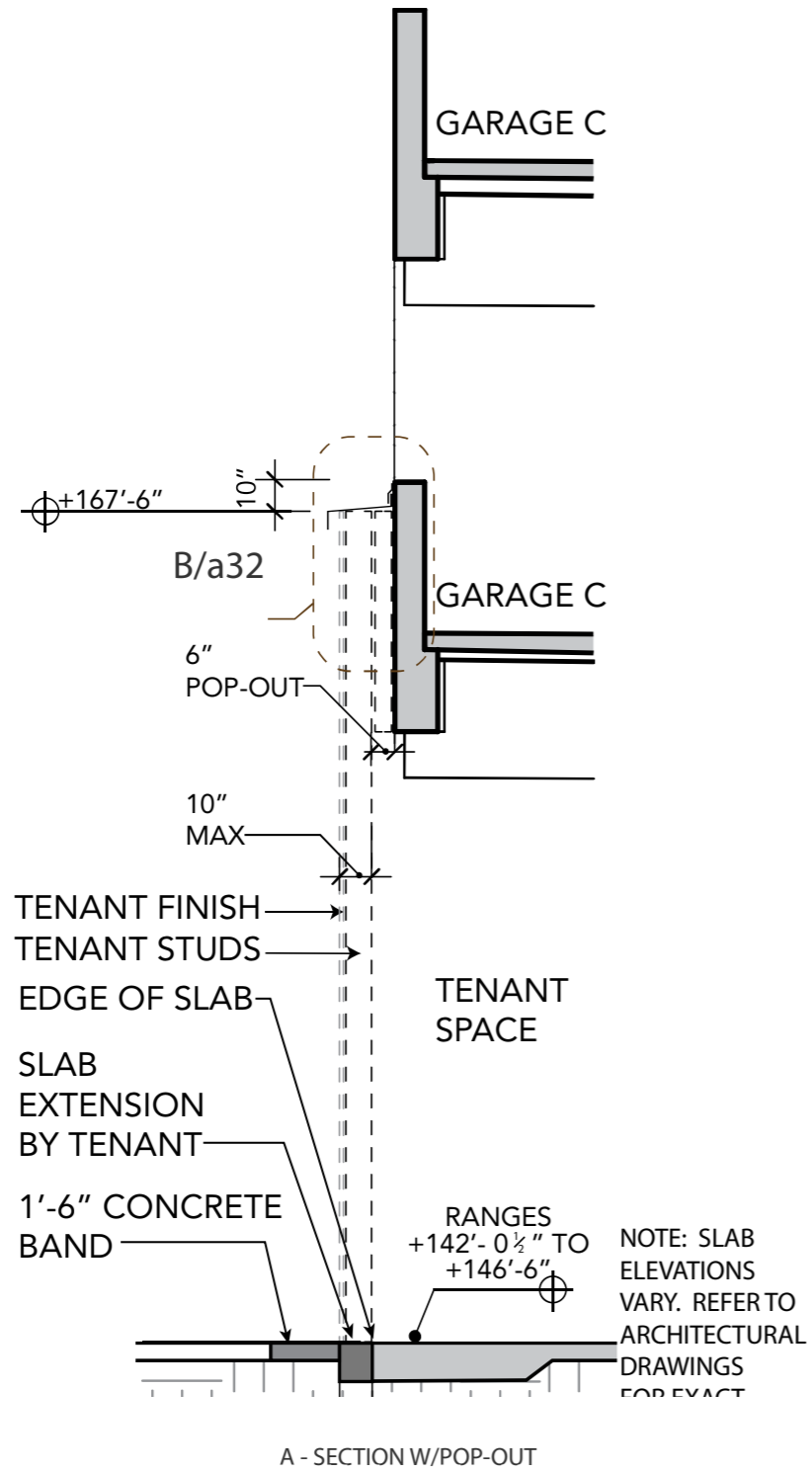



# ZONE 2 SOUTH CRITERIA

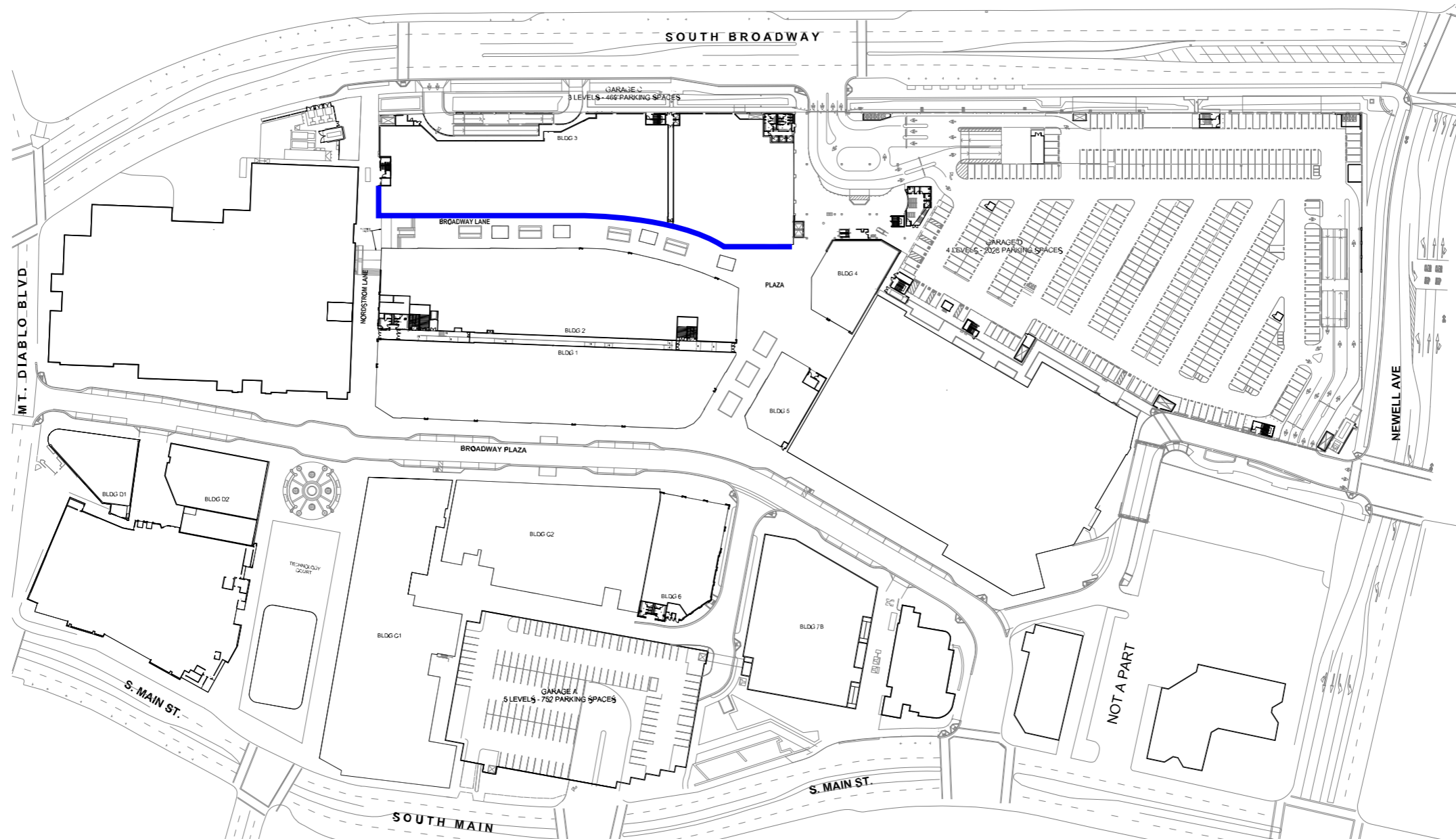

## SOUTH HALF

- There are no pop-outs under the Balcony in Zone 2.
- Tenant storefront heights will vary from 21'-4" to 21'-10" depending on slab height at specific location
- There will be no neutral piers. Tenant storefronts will come directly into contact with one another. Storefronts cannot butt up to one another on the same plane - there must be a minimum of 3" separation from the face of one storefront to the next at the transition..
- Each Tenant storefront must independently be watertight and should be designed as if it's the first storefront. Where neighboring Tenant storefront exists, it should be treated as a neutral pier and remain undisturbed.
- Where they occur, the Landlord pilasters must remain undisturbed.
- Where rear facade is exposed to the street, it must be finished as a Tenant storefront and have a display presence. See Tenant Coordinator for further details.



> TECHNICAL DIAGRAMS > TENANTS UNDER BALCONY

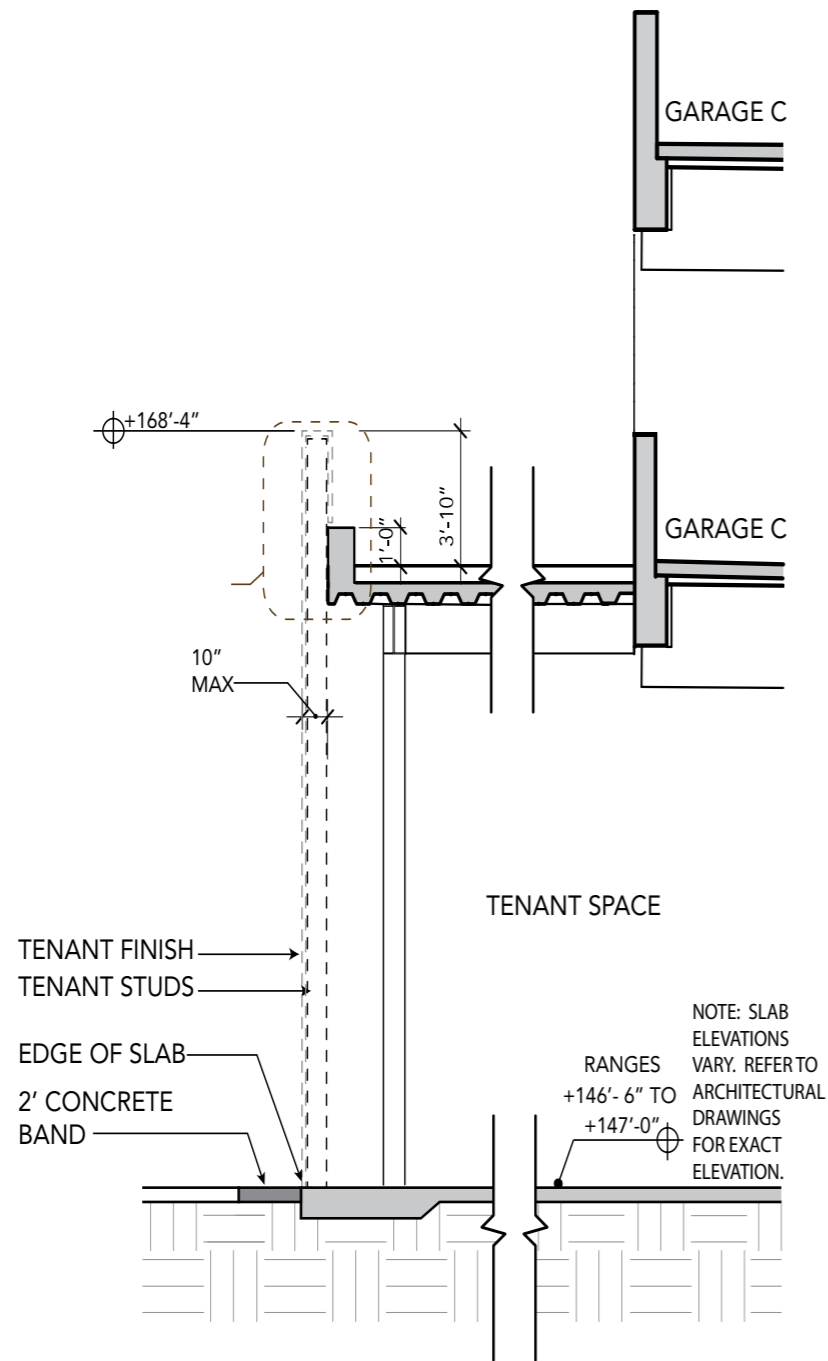

A - SECTION FOR SOUTH HALF W/NO POP-OUT

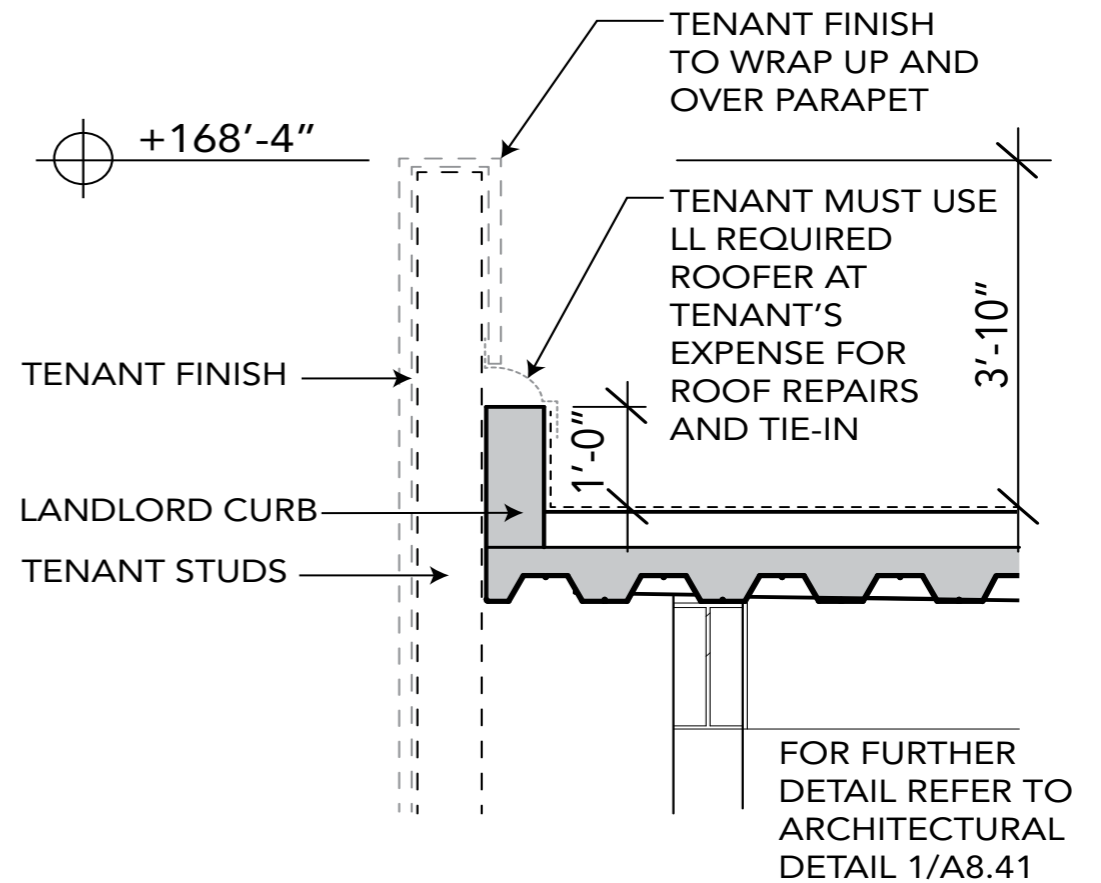

B - DETAIL AT TOP OF STOREFRONT W/NO POP-OUT

# > TECHNICAL DIAGRAMS

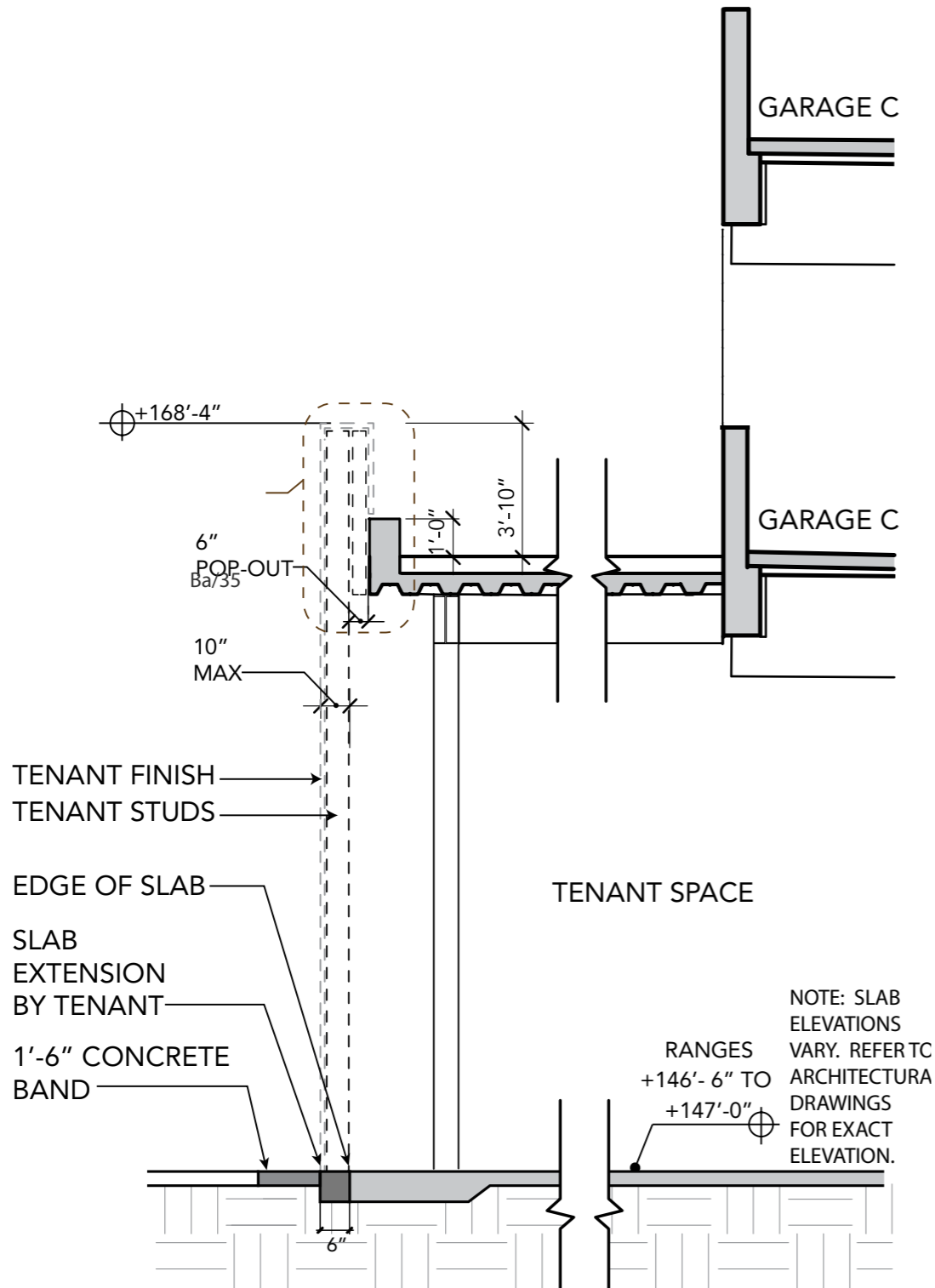

A - SECTION FOR SOUTH HALF W/POP-OUT

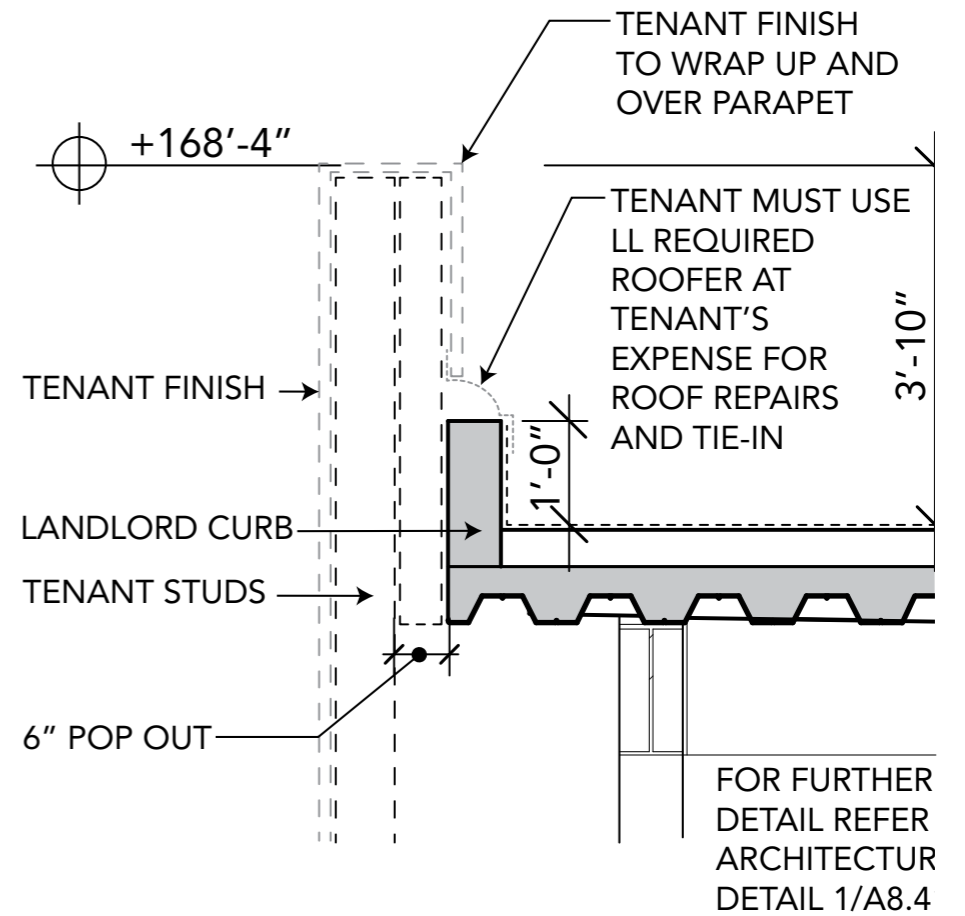

B - DETAIL AT TOP OF STOREFRONT W/POP-OUT



# > TECHNICAL DIAGRAMS

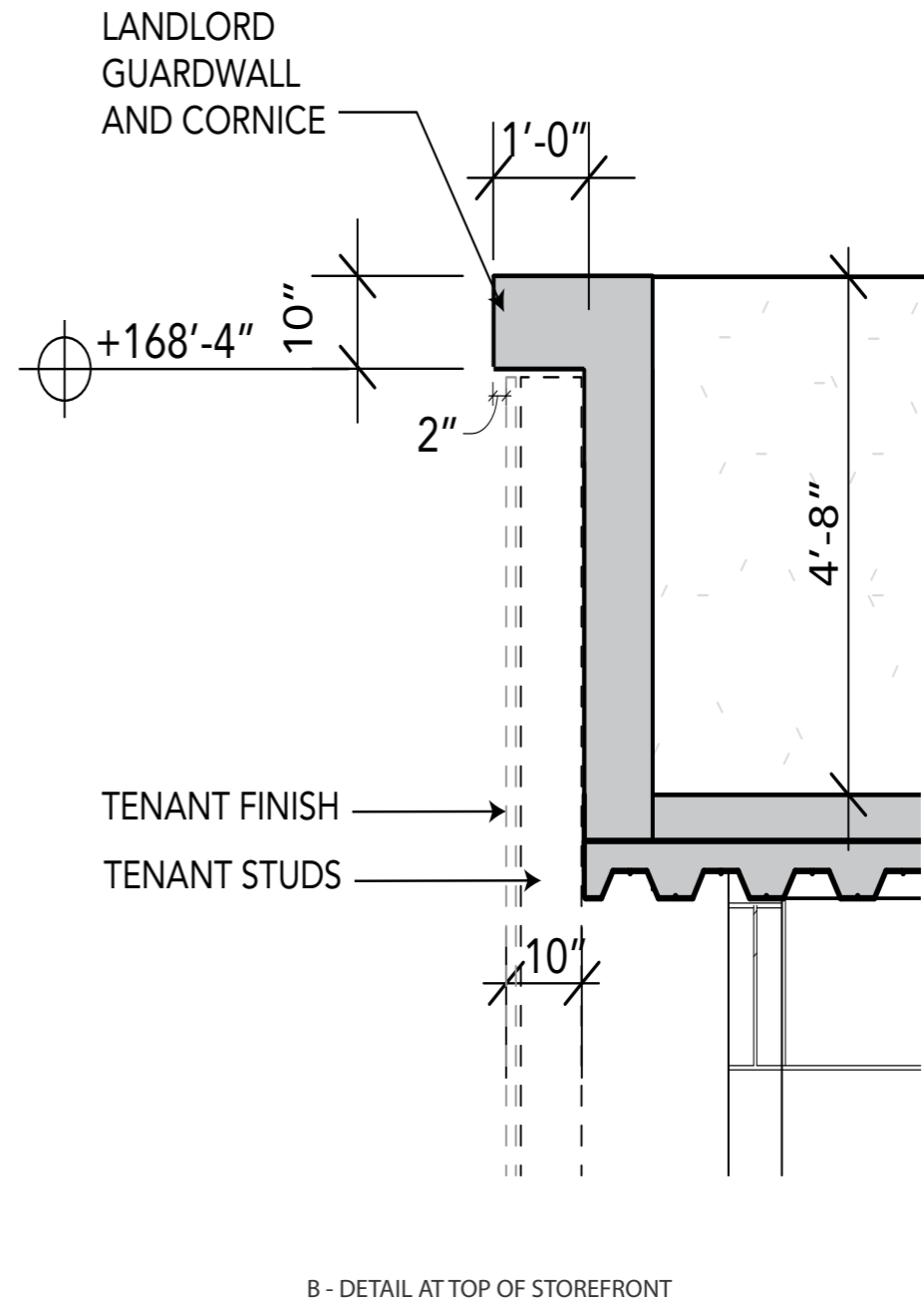
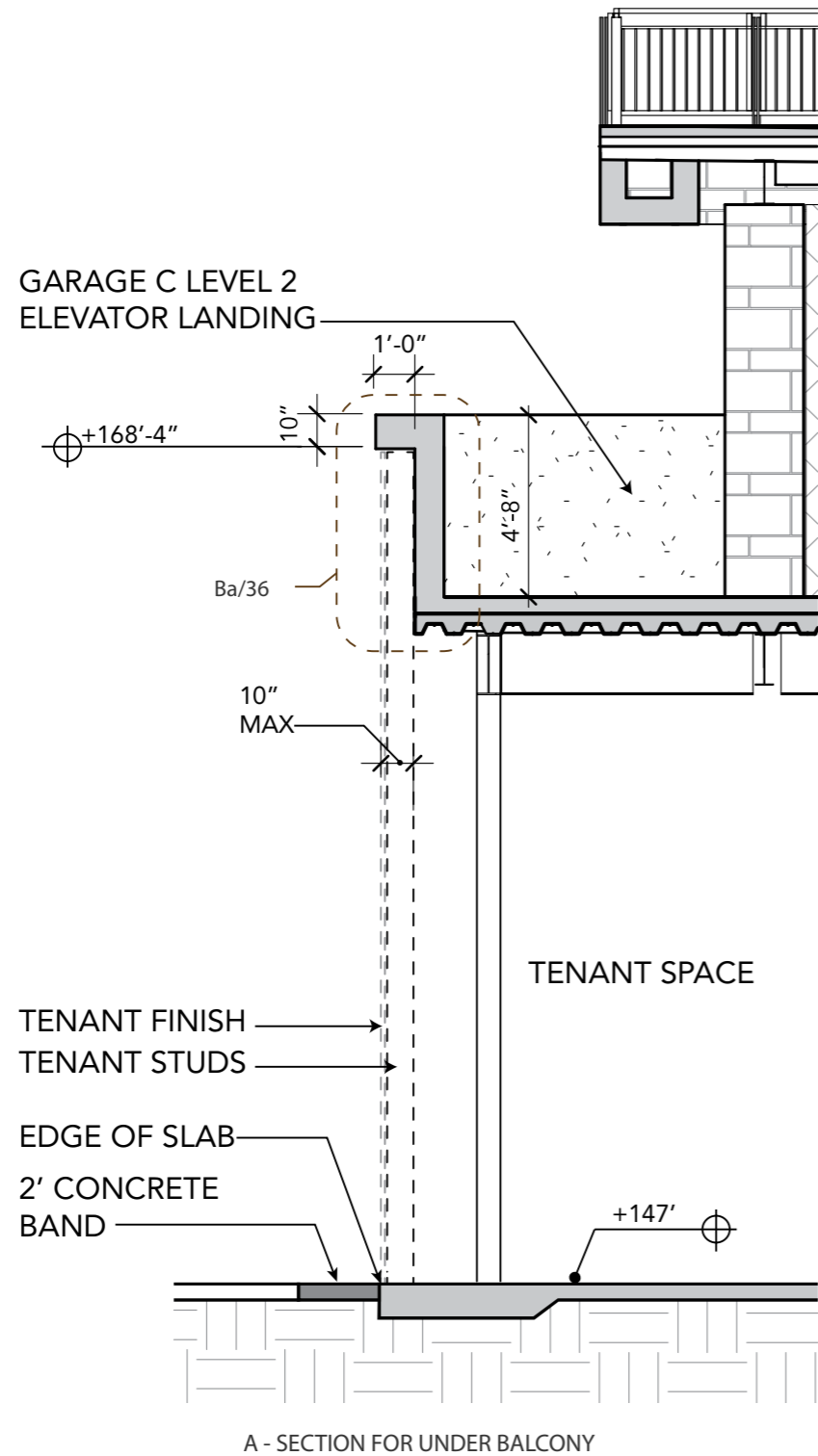

# > SPECIAL CONDITION DIAGRAMS

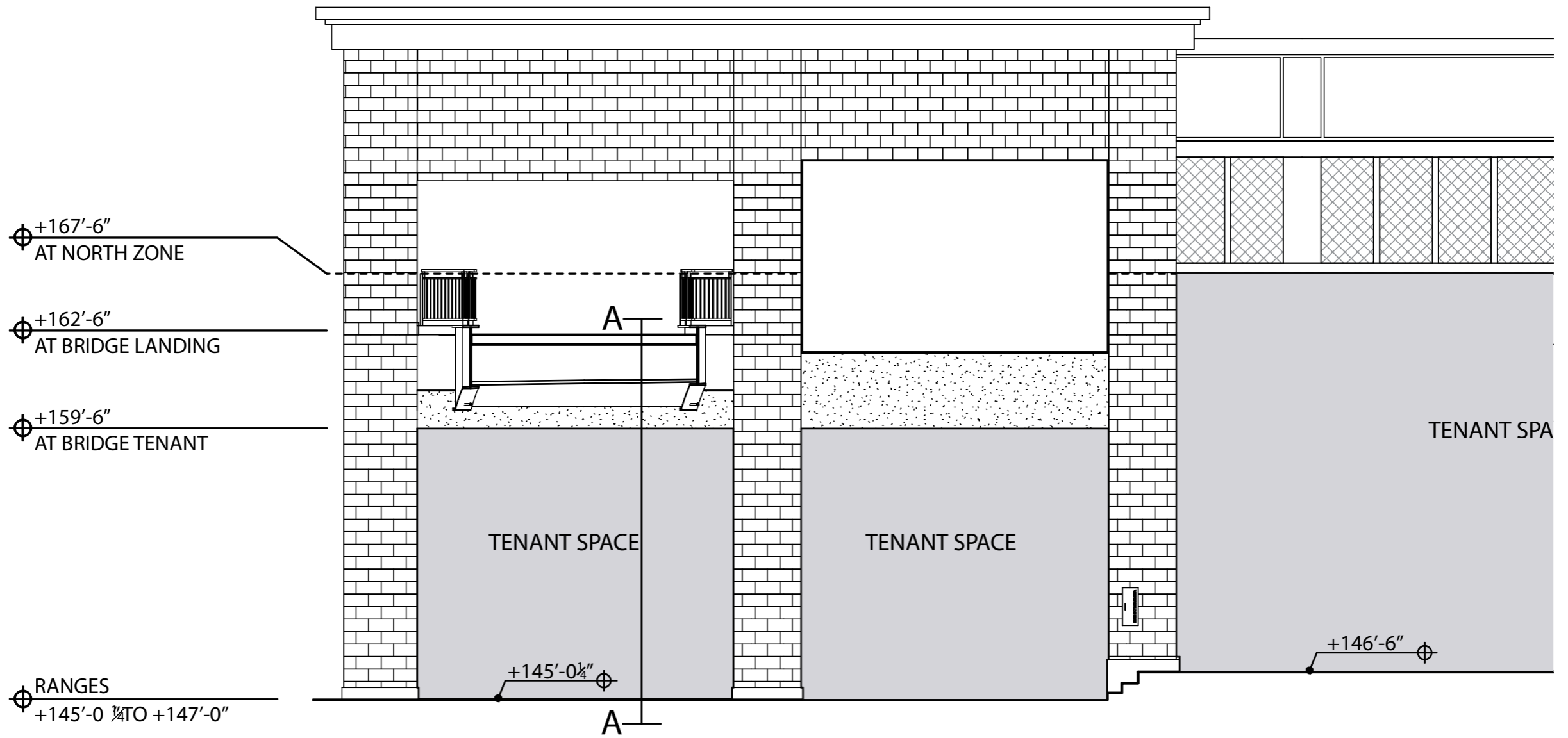

A - WEST ELEVATION OF BUILDING 3 AT PEDESTRIAN BRIDGE

# > SPECIAL CONDITION DIAGRAMS

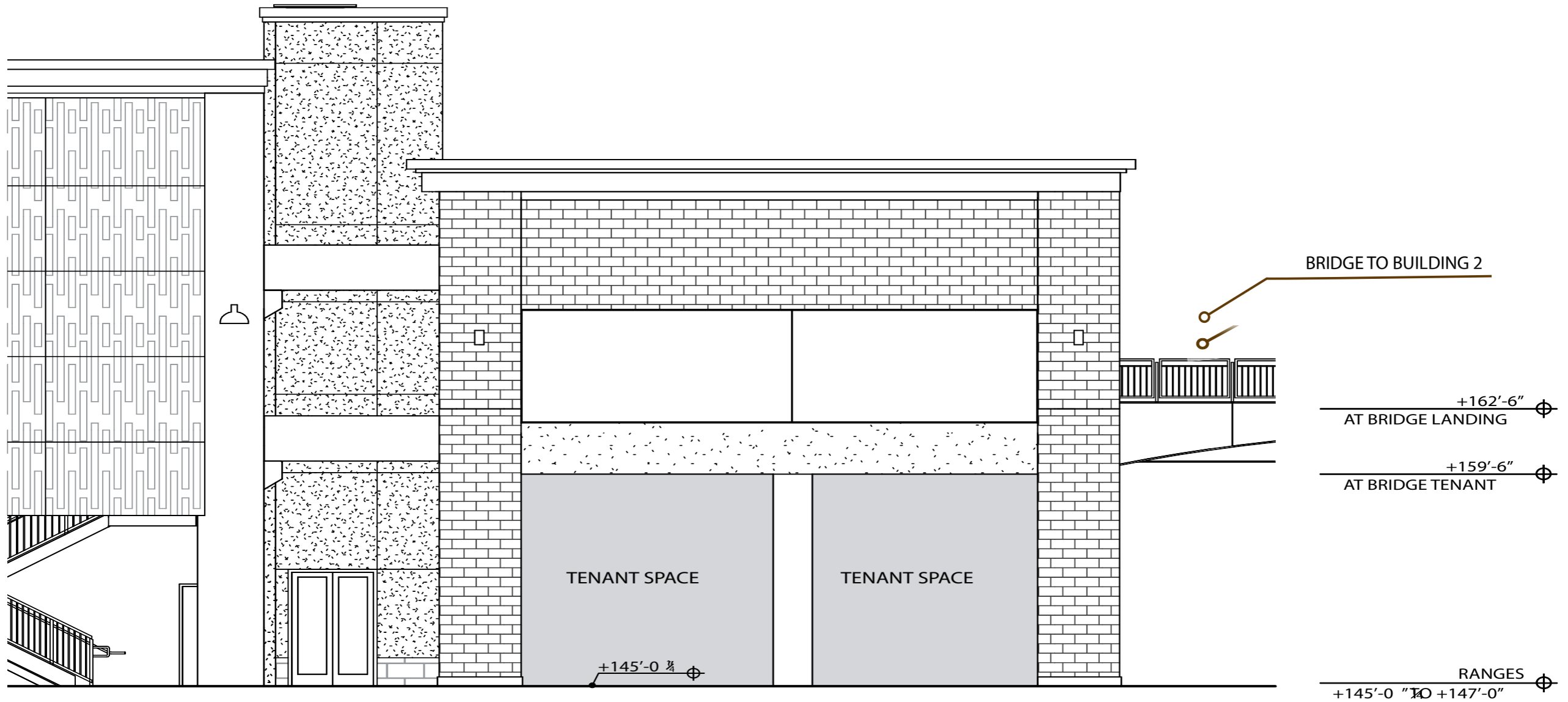

A - NORTH ELEVATION OF BUILDING 3 AT PEDESTRIAN BRIDGE



# > SPECIAL CONDITION DIAGRAMS

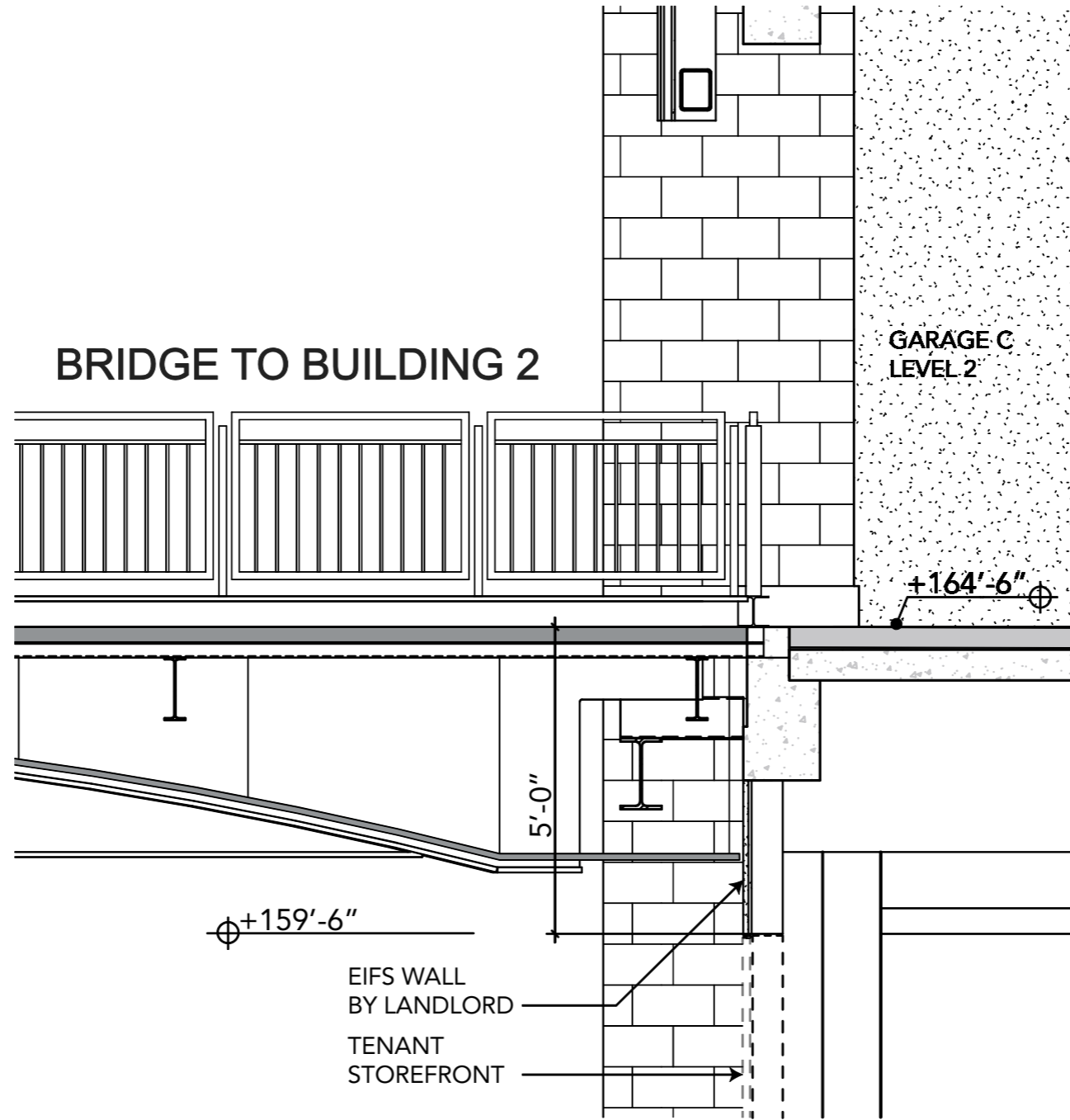

B - A-A SECTION AT PEDESTRIAN BRIDGE



# ZONE 3 CRITERIA

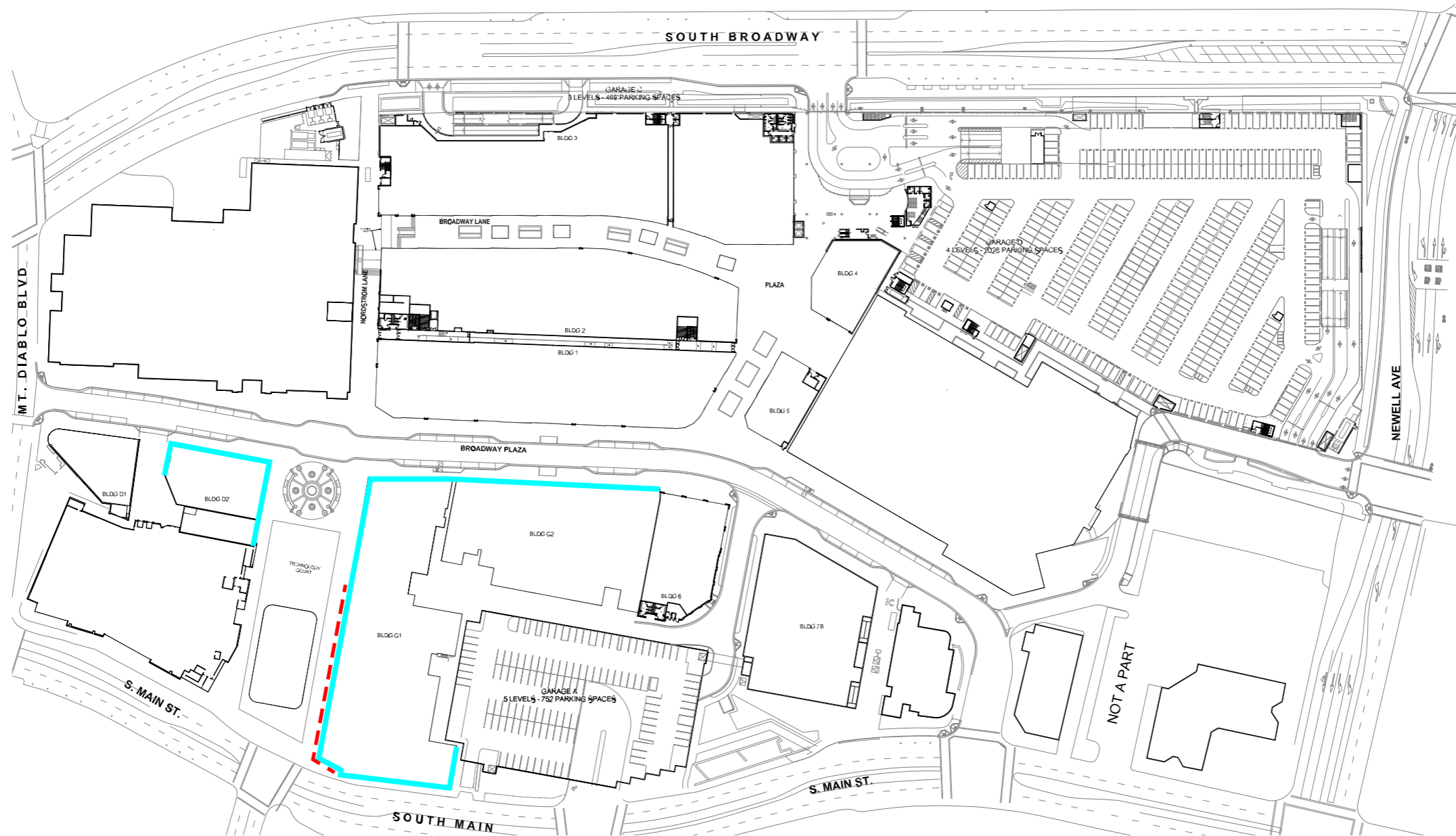

- Tenant may project storefront out up to 16" if indicated on Landlord's LOD but in no case beyond the property line or other limits as directed.
- Tenant storefront must extend maximum distance as shown on LOD a minimum of 24" on both sides of the storefront.
- Up to 70% of frontage may project to maximum depth indicated on the LOD.
- Storefront must extend full height to the top of the parapet.
- Existing neutral piers will be replaced by Tenant's storefront. Tenant should extend their storefront to lease line and incorporate any portion of neutral pier that occurs within their design.

- Extent of allowable projection to be determined by Landlord, and may be subject to review by the City of Walnut Creek Design Review.
- There will be no neutral piers, Tenant storefronts will come directly into contact with one another, but cannot be on the same plane at point of connection.
- Where they occur, the Landlord pilasters must remain undisturbed. Where they occur, the Landlord pilasters must remain undisturbed.
- Each Tenant storefront must independently be watertight and should be designed as if it's the first storefront. Where neighboring Tenant storefront exists, it should be treated as a neutral pier and remain undisturbed.

— — — • **SPECIAL CONDITION:** Tenant storefront along this dashed line shown above must have a 1 hour rated storefront construction from grade level to top of parapet.



⊕ RANGES  
+166'-0" TO +168'-0"

⊕ +157'-6"  
VIF

⊕ +142'-0"  
VIF

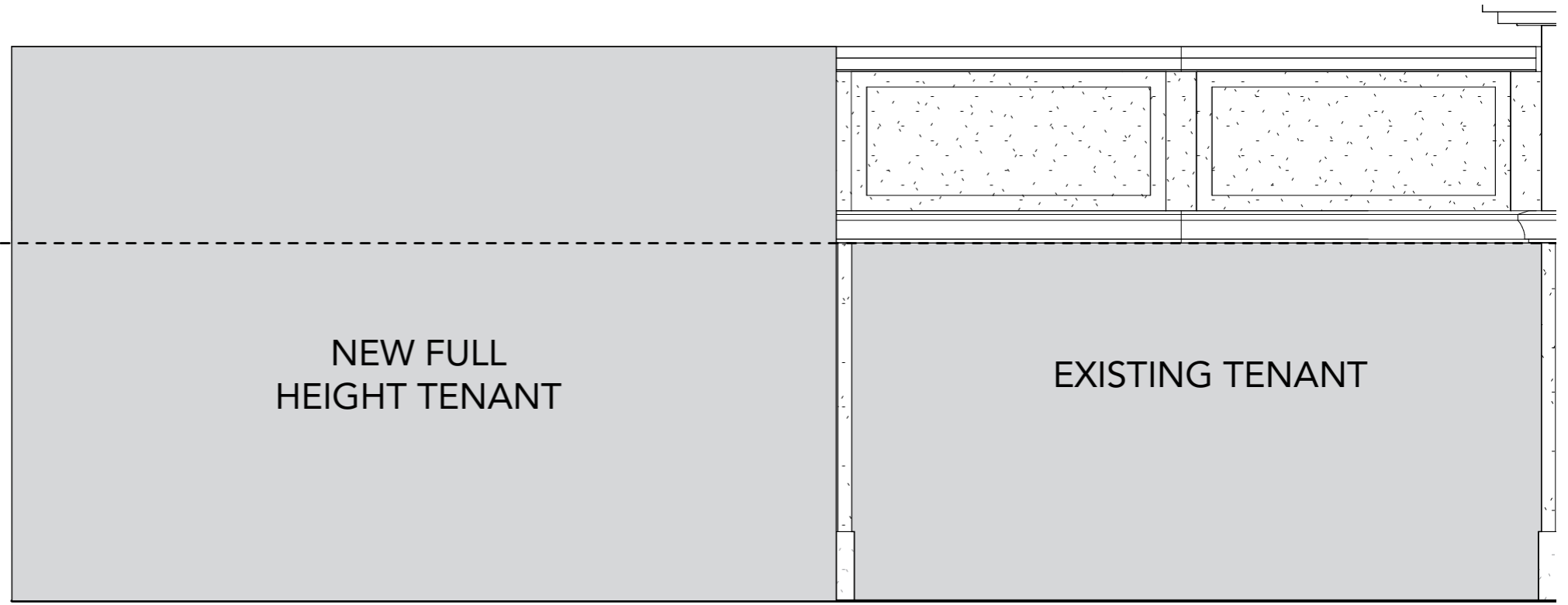

A - ELEVATION



**DETAILS, PHOTOS & GRAPHICS**



# > TECHNICAL DIAGRAMS

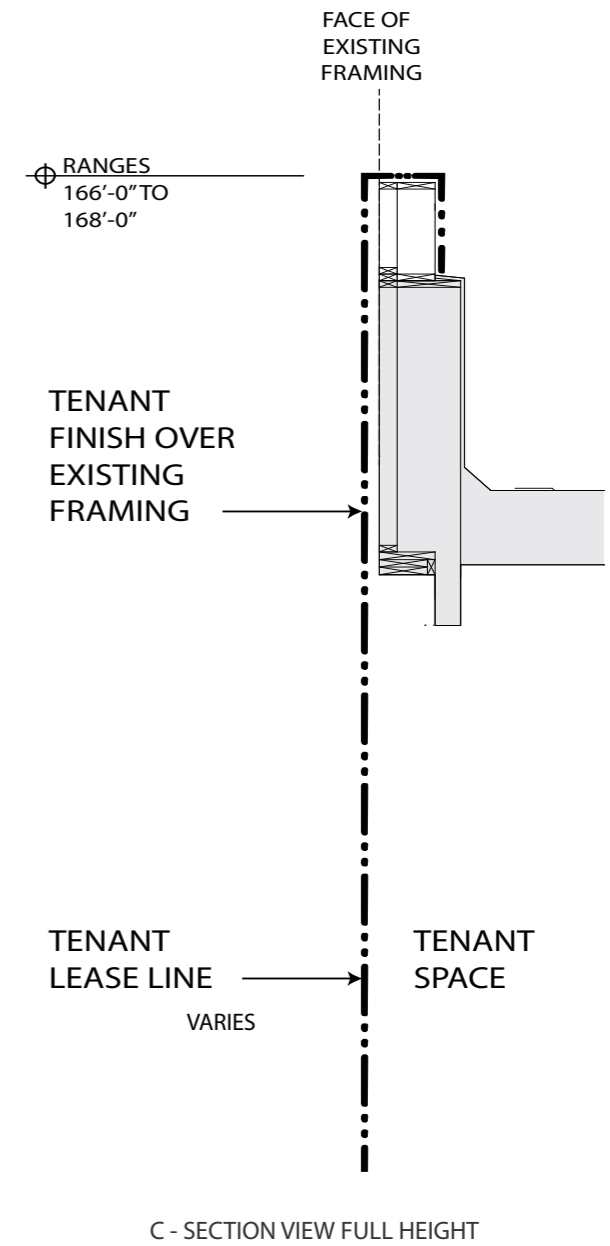
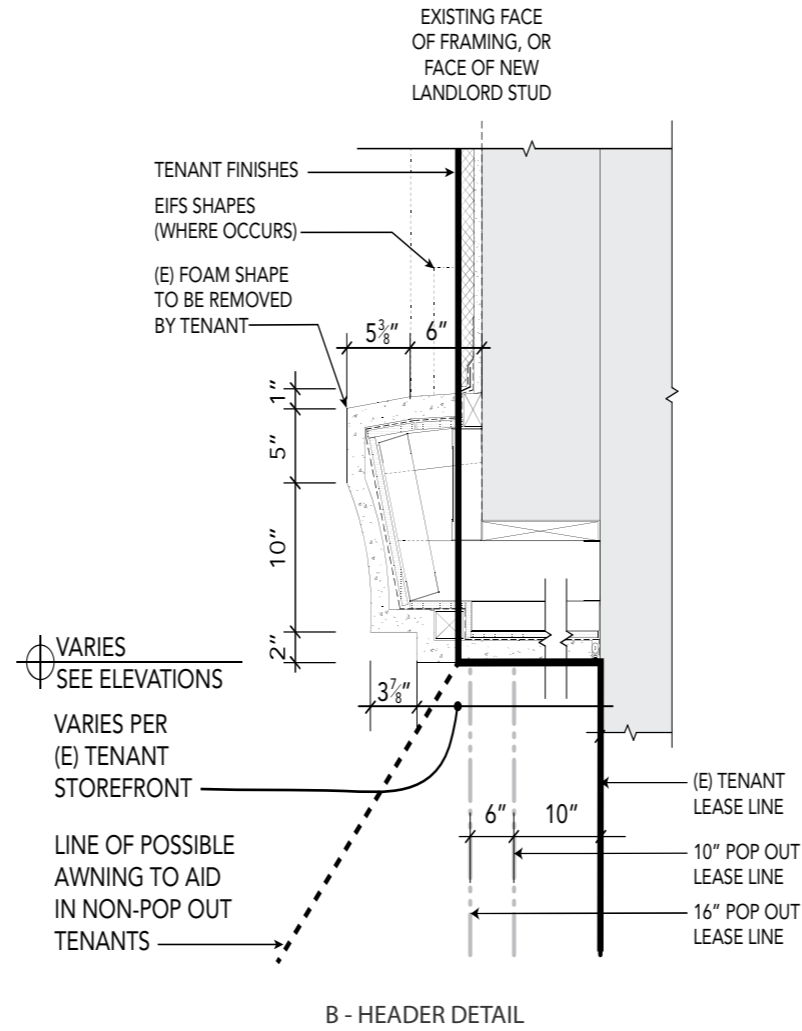
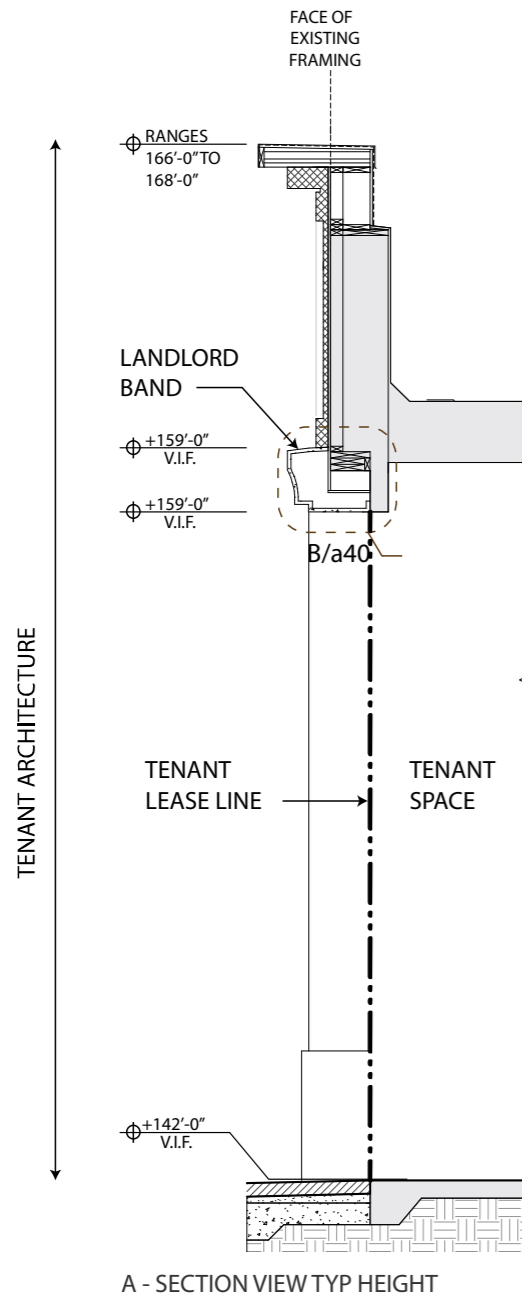

# > TECHNICAL DIAGRAMS

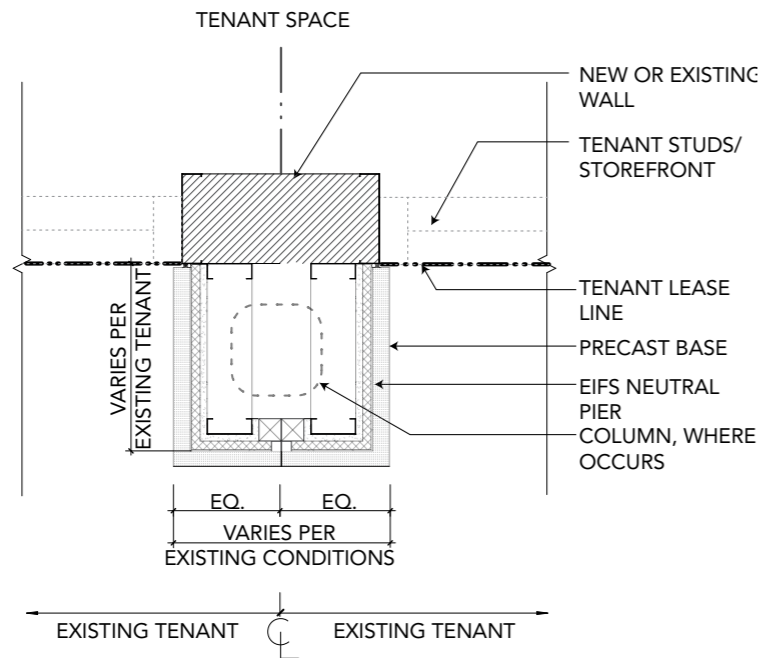

A - EXISTING NEUTRAL PIER CONDITION

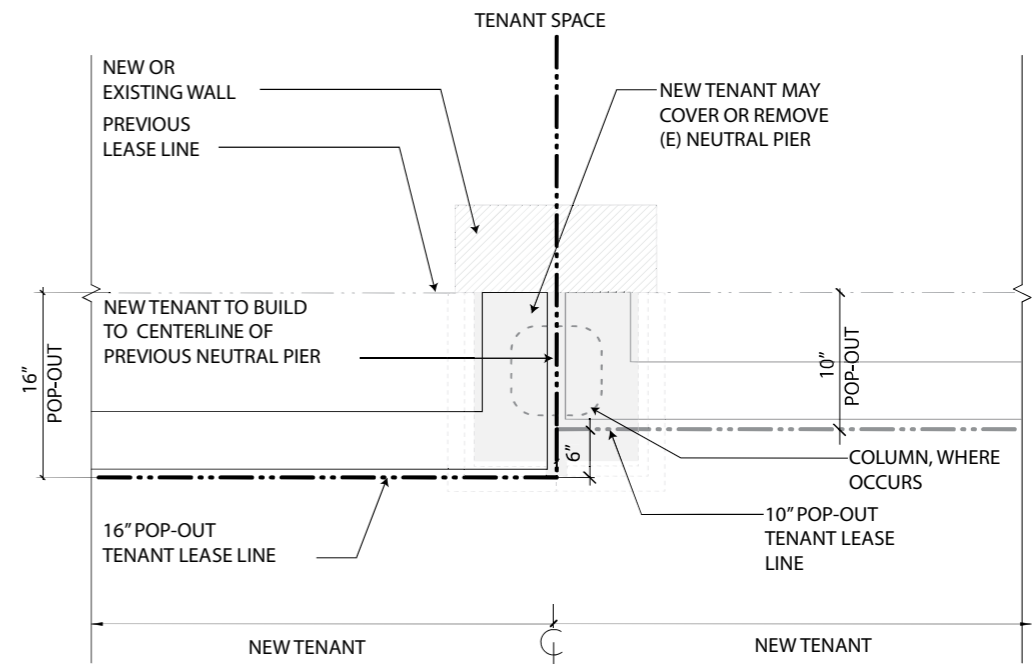

C - NEUTRAL PIER W/TWO NEW TENANTS

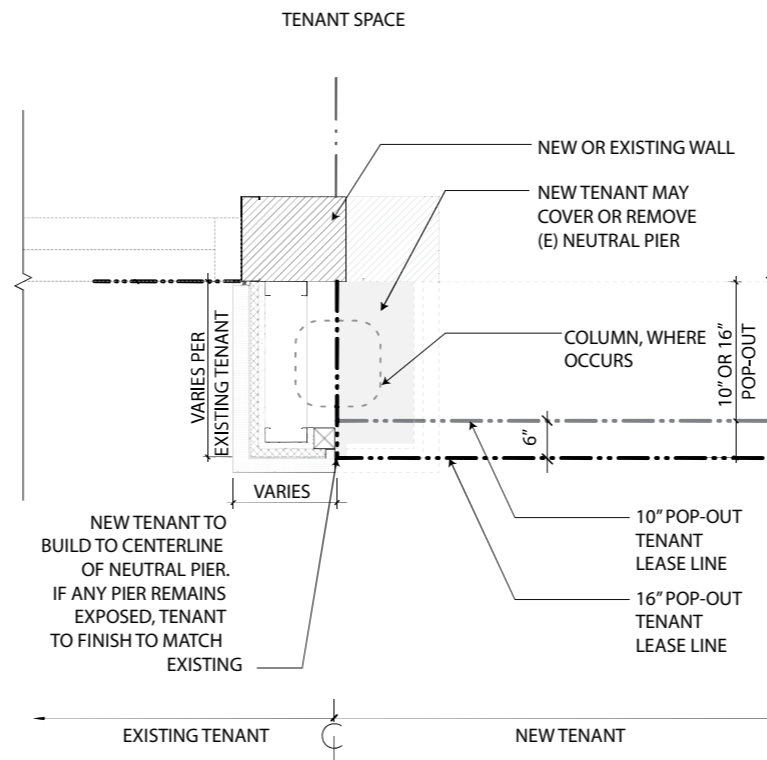

B - NEUTRAL PIER W/ONE NEW TENANT

# ZONE 4 CRITERIA

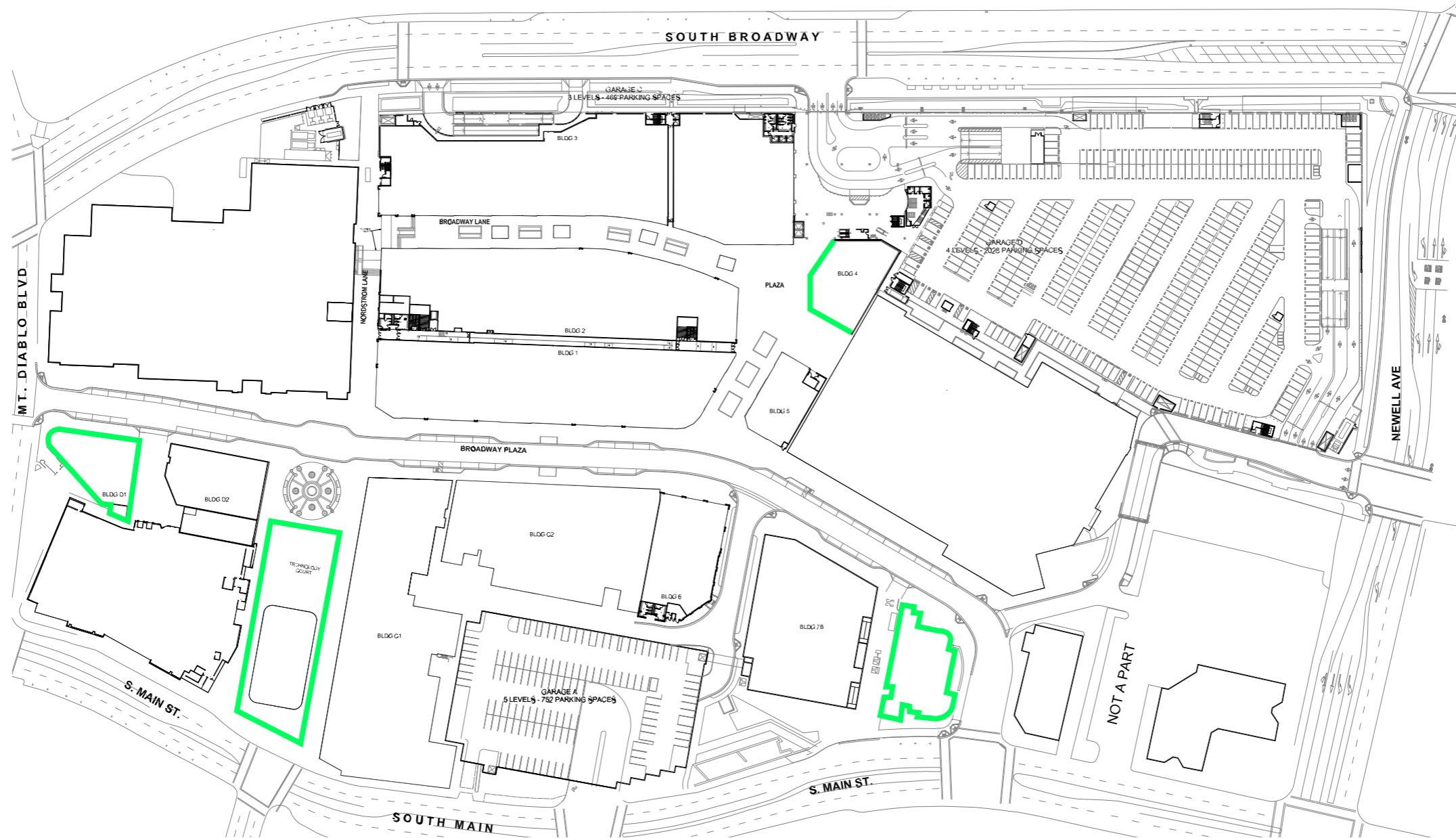

The buildings within this zone do not have Landlord finishes or neutral piers. Tenant storefront designs should extend to full height of the building and to lease lines on both sides. Heights will vary depending on building and location within each building.

- There will be no neutral piers, Tenant storefronts will come directly into contact with one another, but cannot be on the same plane at point of connection.
- Each Tenant storefront must independently be watertight and should be designed as if it's the first storefront. Where neighboring Tenant storefront exists, it should be treated as a neutral pier and remain undisturbed.
- Where they occur, the Landlord pilasters must remain undisturbed. Where they occur, the Landlord pilasters must remain undisturbed.
- Storefronts cannot butt up to one another on the same plane—there must be a minimum of 3" separation from the face of one storefront to the next at the transition.
- Tenant finishes must extend up to and include the parapet, including appropriate flashing and roof repairs.





# ZONE 5 CRITERIA

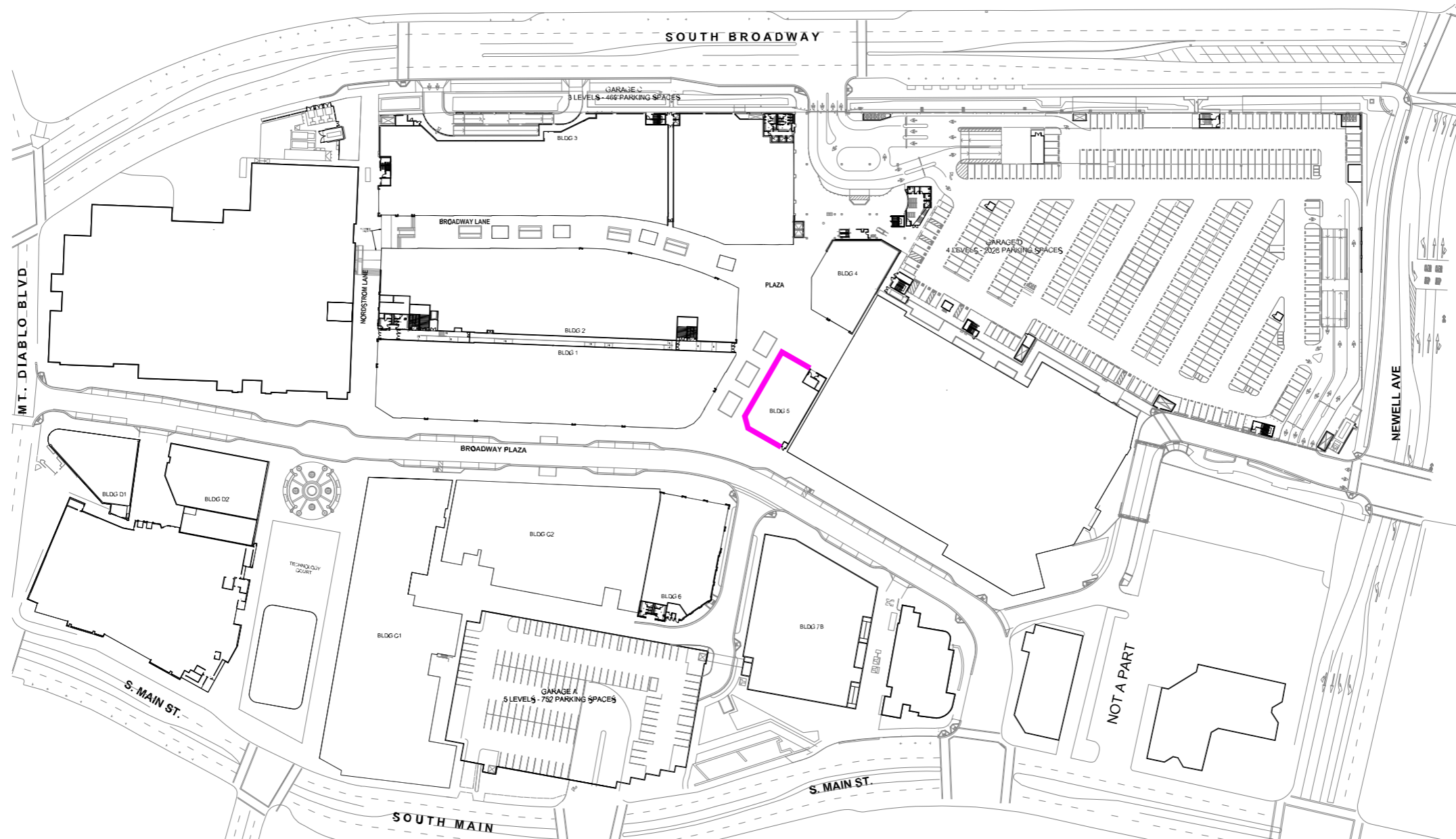

- Tenant may project storefront out up to 6" if indicated on the Landlord's LOD but in no case beyond the property line or other limits.
- When pop-out is shown on LOD a minimum of 24" on both sides of the storefront must pop-out the maximum depth.
- Where pop-out occurs up to 70% of frontage may project to maximum pop-out depth.
- Tenant storefront heights will vary from 15'-9" to 16'-0" depending on slab height at specific location.
- There will be no neutral piers, Tenant storefronts will come directly into contact with one another, but cannot be on the same plane at point of connection. There must be a minimum of 3" separation from the face of one storefront to the next at the transition.

- Each Tenant storefront must independently be watertight and should be designed as if it's the first storefront. Where neighboring Tenant storefront exists, it should be treated as a neutral pier and remain undisturbed.
- Where they occur, the Landlord pilasters must remain undisturbed.
- Tenant storefront must extend full height up to and include the parapet.
- Full storefront on both levels must be finished by Tenant including situations where the second level does not stack directly over the first level.



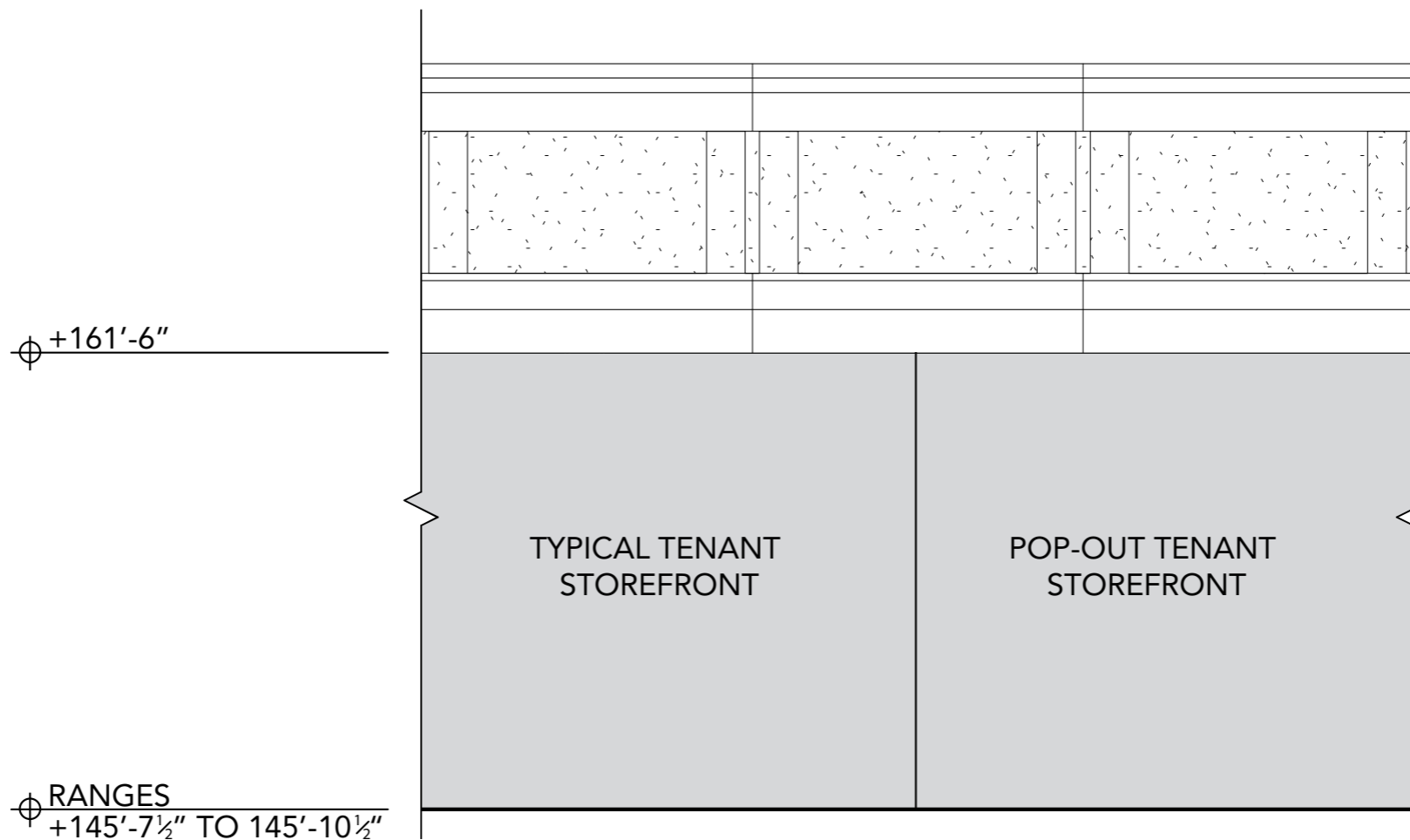

A - ELEVATION

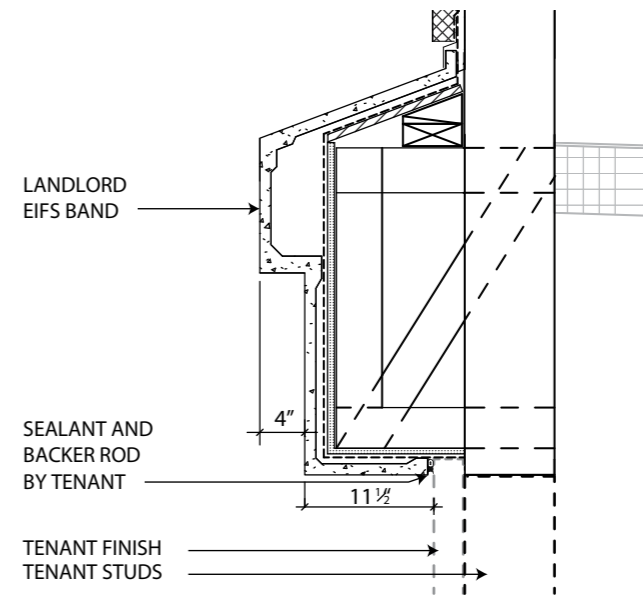
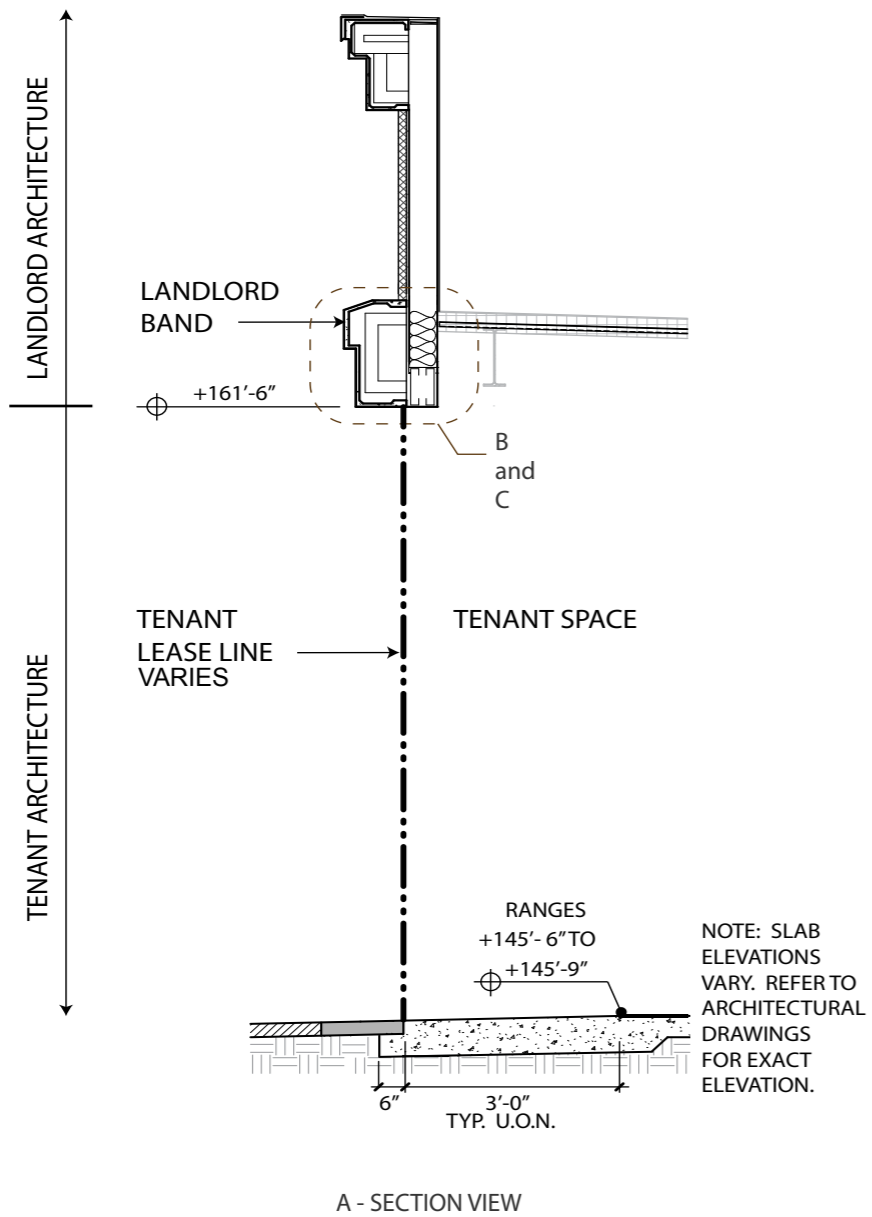

B - HEADER DETAIL W/NO POP-OUT

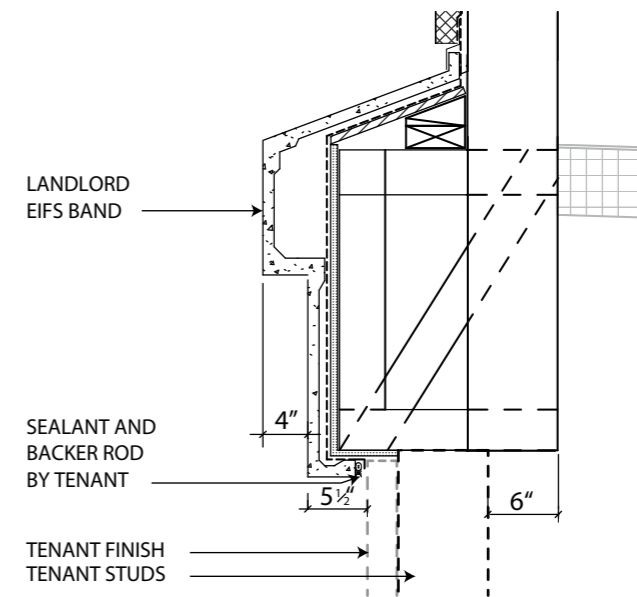

C - HEADER DETAIL W/POP-OUT



# ZONE 6 CRITERIA

Zone 6 Requirements are pending.



# DESIGN INSPIRATION CONTENT OVERVIEW

4.1

## VISUAL CONCEPTS

GUIDE TO DIFFERENT AESTHETIC CONCEPT ENCOURAGING VIBRANT STORE DESIGNS.

4.2

## KEY DESIGN ELEMENTS

OVERVIEW OF THE CORE DESIGN ELEMENTS TO EMBRACE WHEN CREATING AN ENLIVENING RETAIL EXPERIENCE.

**The vibrant character of great shopping destinations is comprised of exceptional storefronts with texture, color, lighting, graphics and merchandising enlivening the pedestrian experience.**

Tenants are encouraged to express their individuality and their brand identity through excellent design by forward thinking design teams.





# VISUAL CONCEPTS > OVERVIEW

- ARTISAN
- URBAN
- WHIMSICAL
- INVITING
- ARTSY
- THEATRICAL

This section highlights six design concepts encouraged by Macerich for Tenant's looking for additional store design inspiration. Our design team welcomes Tenants to engage in these concepts and invites open collaboration in an effort to create store designs that enhance the retail experience.

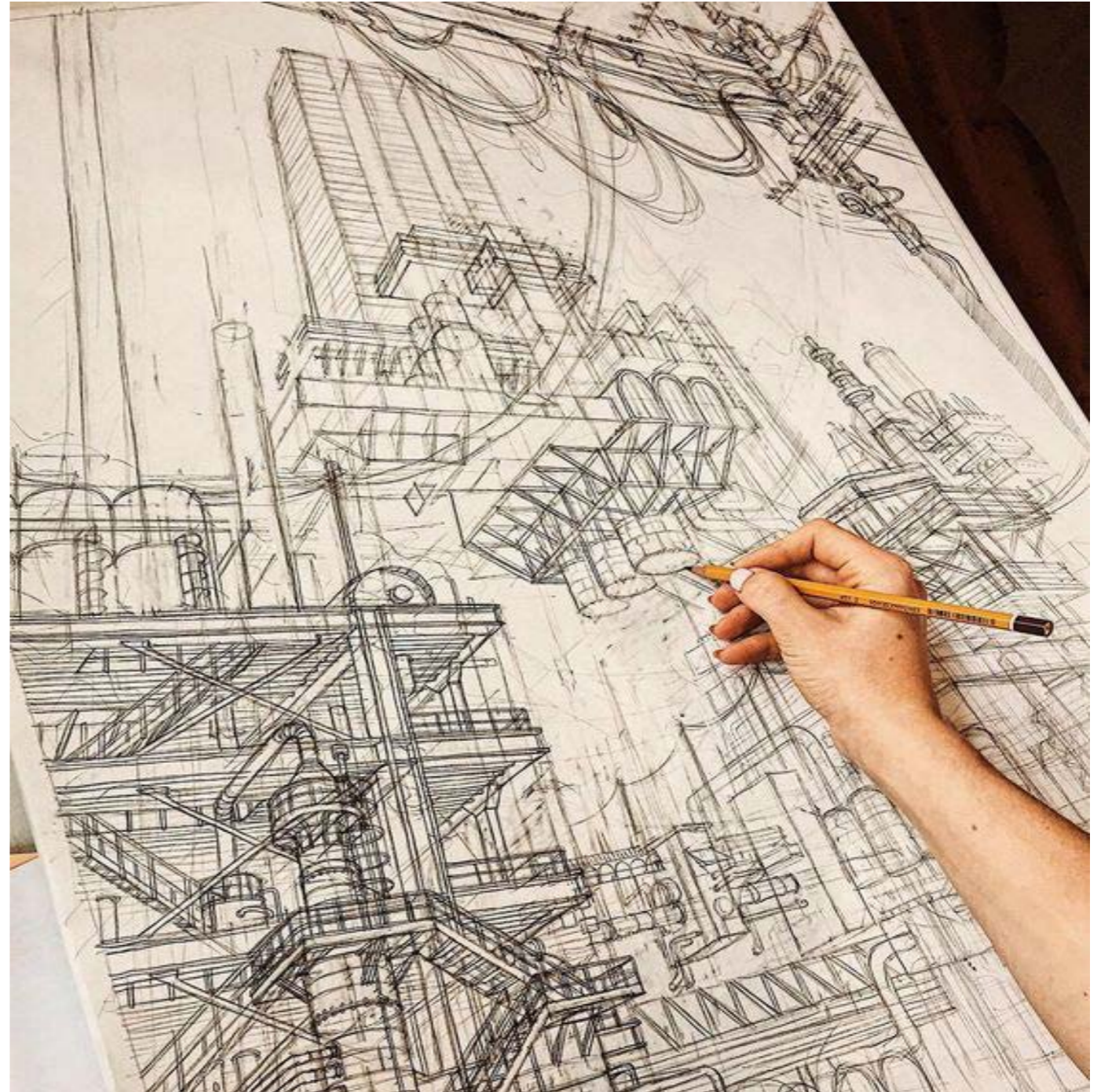



> ARTISAN

# ARTISAN

NATURAL, SOPHISTICATED, UNIQUE





> URBAN

# URBAN

EDGY, FUNKY, STREET SAVVY STYLE, INDUSTRIAL

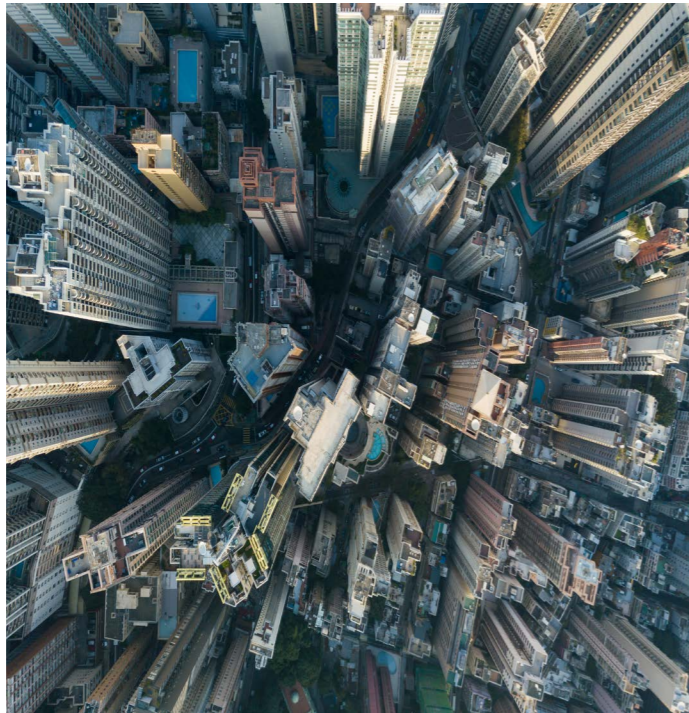



> WHIMSICAL

# WHIMSICAL

UNEXPECTED, PLAYFUL, COLORFUL





> INVITING

# INVITING G

WARM, CALM, OPEN, SOFT





> ARTSY

# ARTSY

QUIRKY, AVANT GARDE, SURPRISING





> THEATRICAL

T H E A T R I C A L  
DRAMATIC, HIGH CONTRAST, MOVEMENT





# KEY DESIGN ELEMENTS > BRANDING / VISUAL MERCHANDISING

Macerich embraces four key design elements to engage customers and encourage store traffic and sales. Strong use of textures, colors, lighting, graphics, and merchandising in these elements help draw customers and inviven the pedestrian experience.

## BRANDING

A brand is a name, term, design, symbol, color or some other feature that identifies a seller's product or services as distinct from those of other seller's.

Your branding can be communicated with signage, graphics, materials, shapes, colors, textures, patterns and the overall look and feel of your kiosk, to tell a story and create a lasting experience.

## VISUAL MERCHANDISING

Strong visual presentation and merchandising are essential and integral components of retail design.

- Attempt to create triangular composition within style groups or color groups. (display in groups of three or five).
- Start with a center feature, (best sellers and hot items), and merchandise out symmetrically or asymmetrically in a balanced manner.





## > LAYERING / TECH AND MEDIA

### LAYERING

How can you make a wall / elevation into a canvas for communication to the customer as they walk towards or by your store?

1. Incorporating patterns and textures.
2. Overlaying materials to create dimensionality.
3. Molding shapes to create softness.
4. Overlapping to create shadows and depth.



### TECHNOLOGY AND MEDIA

Technology can enhance your on line operation by transforming your retail space into a multifunctional one, that lends itself to being an in store pick up location, payment booth or advertising billboard.

Integrating technology into your store design can:

1. Become an extension of you.
2. Supplement your salesforce with interactive screens for ordering, design yourself functions and more.
3. Keep your business connected with your customer.
4. Help you tell a story.
5. Help make menu boards easier to update and better communicate your offerings to your customer via LCD screen loops.

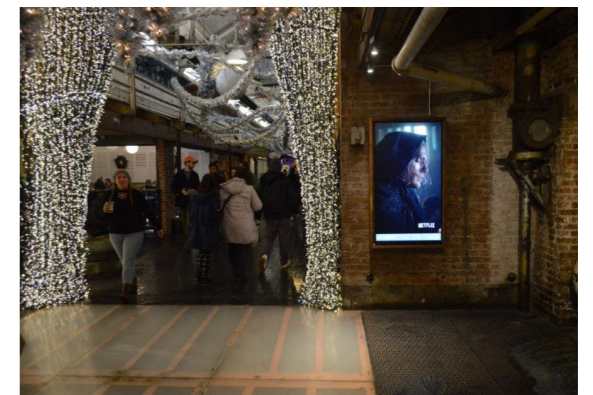



# PROPERTY INFO CONTENT OVERVIEW

5.1

## ADDRESS & HOURS

LOCATION AND SCHEDULE INFO.

5.2

## SITE PLAN

OVERVIEW MAP OF CENTER.

5.3

## CONTACTS

MALL CONTACTS, REQUIRED CONTRACTORS, LOCAL MUNICIPALITIES, AND UTILITY CONTACT INFO.

5.4

## CODES AND PERMITTING

OVERVIEW OF BUILDING CODE, CLASSIFICATIONS, AND LOCAL PERMITTING.

5.5

## OPERATIONS AND UTILITIES

OVERVIEW OF CENTER OPERATIONS AND TYPICALLY AVAILABLE UTILITIES.

5.6

## CONSTRUCTION

OVERVIEW OF CONSTRUCTION PROCEDURES.

### SECTIONS OF INTEREST

The following sections provide additional details and requirements related to this Criteria:

*ADDENDUM*

Provides additional construction requirements to contractors.

The Property Info Criteria provides an overview of the Center's building classification, contacts, local permitting, and typically provided utilities.

It is important to note that the Contacts section includes the Center's required contractors. These contractors **must** be used during the design and buildout of your store.





# ADDRESS & HOURS

## ADDRESS AND HOURS

Broadway Plaza is an outdoor open-air shopping center, located between South Broadway, South Main Street, Mt. Diablo Blvd. and Newell Ave in downtown Walnut Creek, CA.

## Center Address

1275 Broadway Plaza  
Walnut Creek, CA 94596

## Center Hours

MON - FRI  
10 AM - 9 PM

SATURDAY  
10 AM - 7 PM

SUNDAY  
11 AM - 6 PM

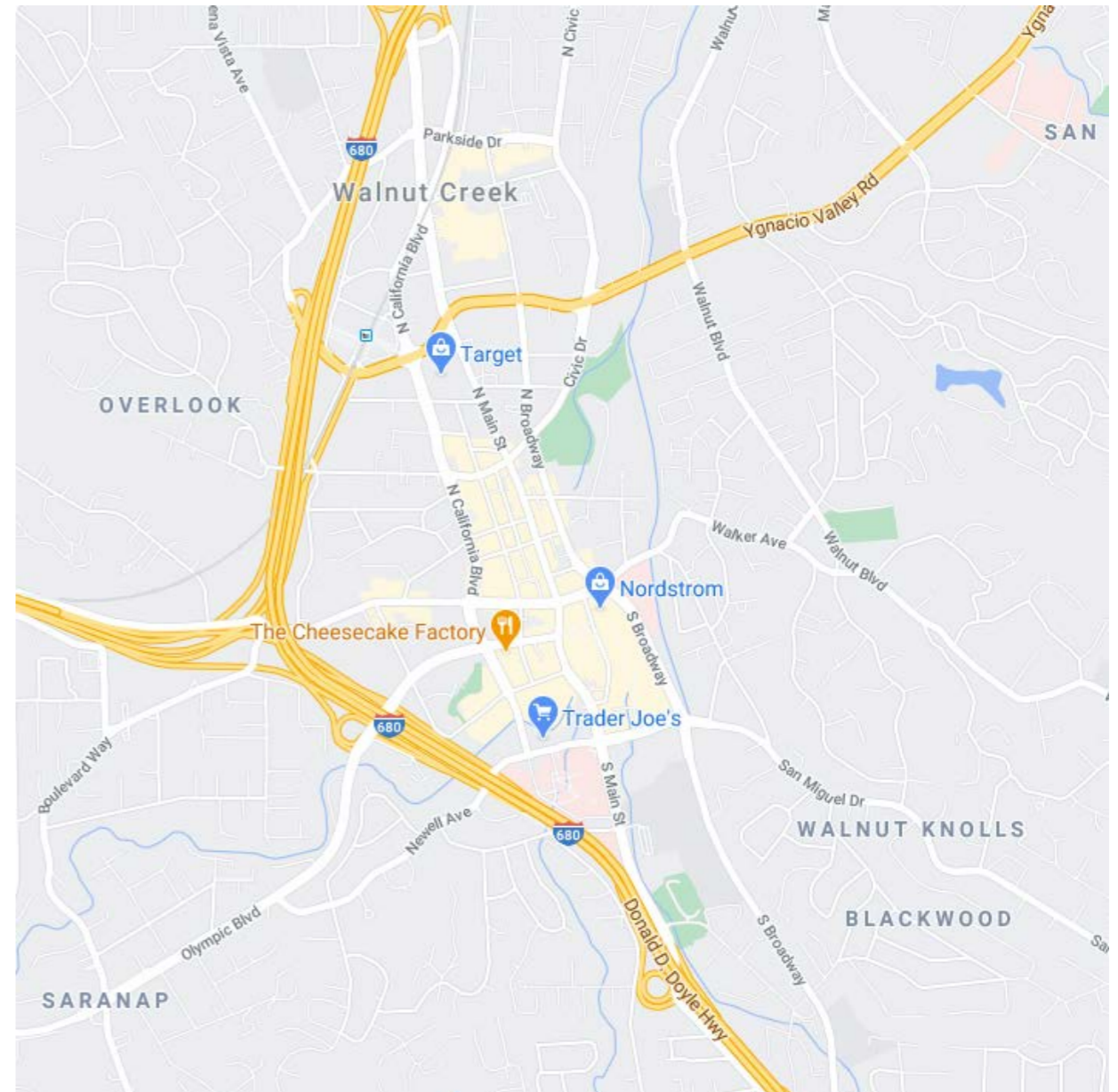

# SITE PLAN

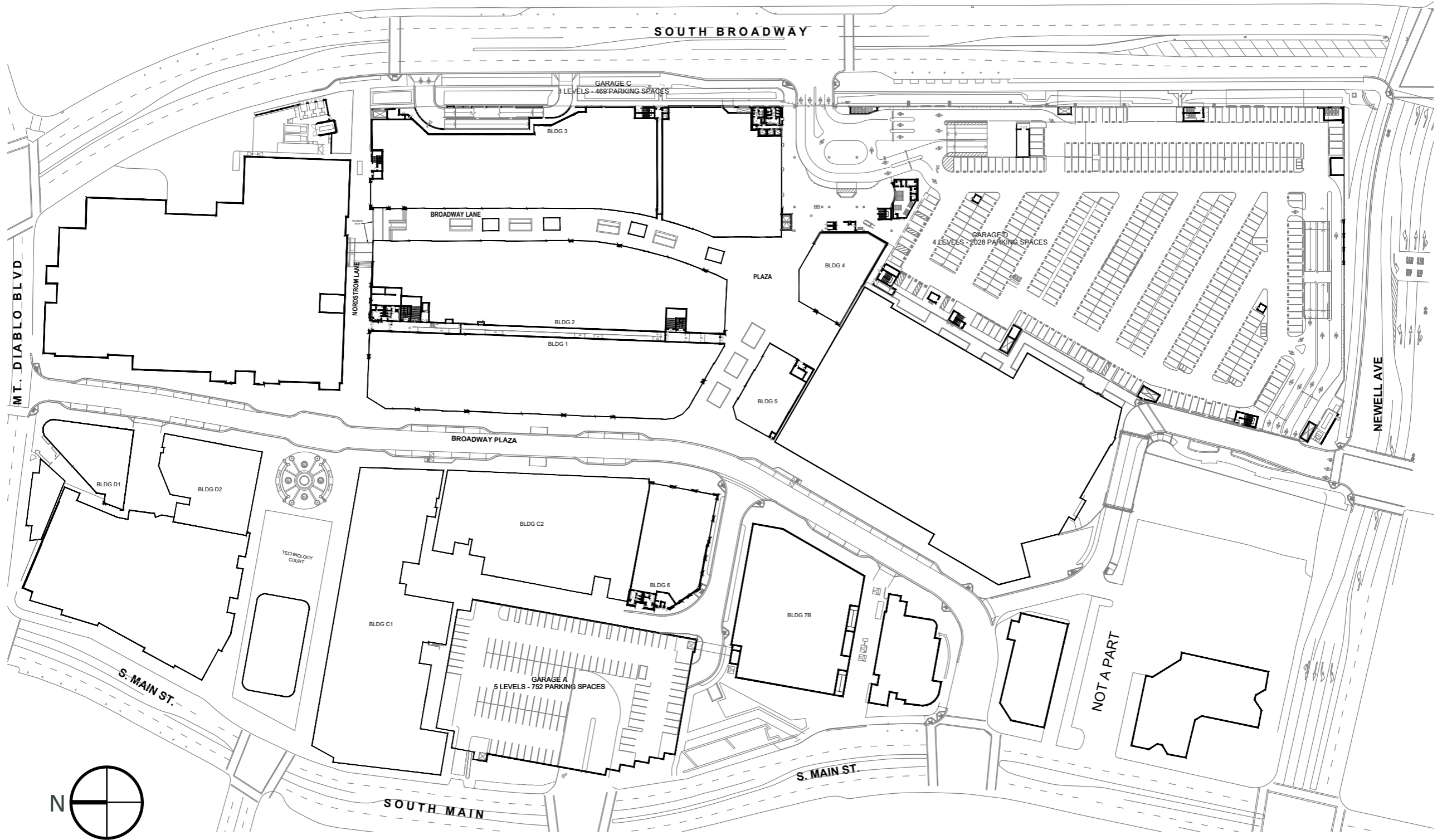

# CONTACTS > PROPERTY TEAM / REQUIRED CONTRACTORS

## **PROPERTY TEAM**

The following points of contacts are available to discuss site details and procedures. The primary point of contact for inquiries is the Tenant Coordinator.

### **PROPERTY MANAGER**

Shelly Dress  
Phone: (925) 287-5033  
[Shelly.Dress@macerich.com](mailto:Shelly.Dress@macerich.com)

### **ASSISTANT PROPERTY MANAGER**

Greg Aguirre  
Phone: (925) 287-5025  
[Greg.Aguirre@macerich.com](mailto:Greg.Aguirre@macerich.com)

### **TENANT COORDINATION**

Kris Vesely, Senior Manager, Tenant Coordinator  
(602) 953-6708 Phone  
[kris.vesely@macerich.com](mailto:kris.vesely@macerich.com)

### **RESTAURANT LEASING**

Jessica Janes  
(424) 229-3542  
[Jessica.Janes@macerich.com](mailto:Jessica.Janes@macerich.com)

### **LEASING**

Erin Byrne  
Phone: (925) 287-5026  
[erin.byrne@macerich.com](mailto:erin.byrne@macerich.com)

### **LANDLORD/OWNER**

The MACERICH Company  
401 Wilshire Blvd., Suite 700  
Santa Monica, CA 90401

## **REQUIRED CONTRACTORS**

The following points of contacts are the required contractors that must perform the construction for their related systems. These contractors are required since they have intimate knowledge of the property building systems and can properly interface Tenant systems with the base building infrastructure.

### **ALL BUILDINGS**

#### **ELECTRICAL CONTRACTOR**

(Any electrical work outside the lease line)  
Powersource Electrical Contractors, Inc.  
Jeff Augusts  
(925) 439-7713  
[jeff@pwrsrc.com](mailto:jeff@pwrsrc.com)

#### **SPRINKLER CONTRACTOR**

Bolls Fire & Safety  
Jared Bolls  
4554 Contractors Place  
Livermore, CA 94551  
(925) 963-2982  
[jbolls@bollsfire.com](mailto:jbolls@bollsfire.com)

#### **VOLTAGE**

Rob Norton  
Granite Services  
(781) 884-5545  
[rnorton@granitenet.com](mailto:rnorton@granitenet.com)

#### **FIRE ALARM CONTRACTOR**

Pacific Signaling Systems  
Aaron Eddy  
5627 Stoneridge Dr. Suite 321  
Pleasanton, CA 94588  
(925) 828-2400  
[aeddy@PacificSignaling.com](mailto:aeddy@PacificSignaling.com)

#### **ROOFING CONTRACTOR**

Alcal Specialty Contracting, Inc.  
Carina Valencia  
(510) 623-5268  
[leaks@alcal.com](mailto:leaks@alcal.com)

#### **ELECTRICAL ENGINEER**

(Must approve all electrical drawings)  
Zeiger Engineers  
Oscar Louie, P.E.  
(510) 452-9391  
[Oscar.louie@natronresources.com](mailto:Oscar.louie@natronresources.com)

#### **NETWORK PROVIDER**

(Phone & Network runs from demark to space)  
**\*\*It is highly recommended to coordinate service install a minimum of 4 weeks in advance**  
GRANITE GRID  
Aaron Clancy  
(857) 344-1909  
[AClancy@granitenet.com](mailto:AClancy@granitenet.com)

#### **BUILDINGS 1, 2, 3, 4, 5 and 6**

#### **ELECTRICAL ENGINEER**

(Main breaker installation and final termination in LL gear)  
OTI  
Jason Dewar  
(510) 368-1312  
[Jason.dewar@otipro.com](mailto:Jason.dewar@otipro.com)

#### **Structural Engineer for approval of concrete saw-cutting/trenching**

KPFF  
David Rossi, SE  
45 Fremont St, 28TH floor  
San Francisco, CA 94105  
(415)989-1004  
[David.Rossi@kpff.com](mailto:David.Rossi@kpff.com)

#### **Structural Engineer**

Wright Engineers  
Tom Allen, SE  
2 Venture, Suite 200  
Irvine, CA 92618  
(949)477-4001  
[tallen@wrightengineers.com](mailto:tallen@wrightengineers.com)

#### **BARRICADES**

Boston Barricade  
Anthony Pham (AGM) Jacky Miranda (PM)  
(925)642-6170 (760)599-9703  
[apham@bostonrs.com](mailto:apham@bostonrs.com) [jmiranda@bostonrs.com](mailto:jmiranda@bostonrs.com)





## > UTILITIES / LOCAL AGENCIES

### **UTILITIES**

#### **DATA**

Data is required to be set up through Granite Grid. Other service providers do not have a Right of Entry agreement and are not permitted.

#### **Granite Grid**

Rob Norton  
(781) 884-5545

#### **ELECTRIC/GAS**

Gas utility is only available for food use. Gas is not available for heating.

#### **PG&E**

#### **Concord Service Center**

1030 Detroit Ave  
Concord, CA 94518  
Paul Carr  
(559) 706-1855  
[pmci@pge.com](mailto:pmci@pge.com)

#### **WATER**

#### **East Bay Municipal Water District (EBMUD)**

375 11th Street  
Oakland, CA 94607

#### **WASTE MANAGEMENT**

2658 N Main Street  
Walnut Creek, CA 94596  
(925) 935-8900

### **LOCAL AGENCIES**

#### **LICENSE AND INSPECTIONS**

Responsible for business licensing, building permits, plan review, site inspections, and Certificate of Occupancy

#### **Community Development Department**

#### **City of Walnut Creek**

1666 N. Main Street  
Walnut Creek, CA 94596  
(925) 943-5834

#### **HEALTH DEPARTMENT**

Responsible for health inspections

#### **Contra Costa Environmental Health**

2120 Diamond Blvd. Suite 200  
Concord, CA 94520  
(925) 692-2500

#### **SANITARY DEPARTMENT**

Responsible for sanitary permits

940 Municipal Services Building  
1401 John F. Kennedy Boulevard  
Philadelphia, PA 19102  
(215) 686-5501

#### **FIRE DEPARTMENT**

Responsible for fire alarm and fire sprinkler permits

#### **Contra Costa County Fire Protection District**

2010 Geary Road  
Pleasant Hill, CA 94523  
(925) 757-1303



## > DESIGN CONTACTS

The following points of contacts relate to the technical systems of the property. They are the designers or record for the property and offer detailed design insight into the building systems.

### **BUILDING ARCHITECT**

#### **Field Paoli Architects**

711 Market Street  
San Francisco, CA 94103  
(415) 788-6606  
Yann Taylor, Principal  
[yet@fieldpaoli.com](mailto:yet@fieldpaoli.com)

### **BUILDING CIVIL ENGINEER**

#### **Kimley-Horn & Associates, Inc.**

1300 Clay Street, Suite 325  
Oakland, CA 94607  
(510) 350-0216  
Felicia Dean  
[Felicia.Dean@kimley-horn.com](mailto:Felicia.Dean@kimley-horn.com)

### **LANDSCAPE ARCHITECT**

#### **Studio Outside**

824 Exposition Ave., Suite 5  
Dallas, TX 75226  
Amy Bartell  
(214) 954-7160 Ext. 135  
[abartell@studiooutside.us](mailto:abartell@studiooutside.us)

### **STRUCTURAL ENGINEER**

#### **KPFF Consulting Engineers**

221 Main Street, Suite 800  
San Francisco, CA 94105  
Blake Dilsworth, Principal  
(415) 495-3700  
[Blake.dilsworth@kpff-sf.com](mailto:Blake.dilsworth@kpff-sf.com)

### **MECHANICAL & PLUMBING ENGINEERS**

#### **Mechanical Design Studio, Inc.**

1801 Oakland Blvd., Suite 110  
Walnut Creek, CA 94596  
Dorel Anghel, Principal  
(925) 210-0100  
[Dorel.anghel@mds-sf.com](mailto:Dorel.anghel@mds-sf.com)

### **ELECTRICAL ENGINEERS**

#### **O'Mahony & Myer**

4340 Redwood Highway, Suite 245  
San Rafael, CA 94903  
Paul Carey, Principal  
(415) 492-0420  
[pcarey@ommconsulting.com](mailto:pcarey@ommconsulting.com)



# CODES AND PERMITTING

## **BUILDING CODE OVERVIEW**

Broadway Plaza offers spaces for retail, restaurants, and entertainment. Below are the pertinent property details related to local building codes. It is the sole responsibility of the Tenant's Architect, Engineers, Consultants, and Contractors to comply with all applicable federal, state, and local codes and ordinances for their occupancy type.

### **Building Type**

Multi-level regional shopping center of approximately 800,000 square feet of Gross Leasable Area.

### **Approved Occupancy Types**

Mercantile

### **Construction Classification**

Open-air center buildings with the following construction types:

Buildings 1, 2, 4, 5, 6, and 7 = Type II-B

Buildings C1, D1, D2 = Type III-A

Building C2 = Type III-B

Building 3 = Type I-B

### **Applicable Codes**

Currently adopted edition of the 2010 California Building Code as amended and adopted by Walnut Creek.

It is the sole responsibility of the Tenant's Architect, Engineers, Consultants, and Contractors to comply with all applicable federal, state, and local codes and ordinances for their occupancy type.

## **PERMITTING**

Tenant construction, signage, and food service all require permitting from the City of Walnut Creek.

### **Building Permit**

For all construction, prior to work commencement, building and other required permits shall be obtained by the Tenant.

Building Permits are filed with the City of Walnut Creek Building Department. Permits are submitted in person at the Building counter, Monday-Thursday. All city fees must be paid at the time of submittal and those costs are determined at the time of submittal.

The permit review process, called the Permit Streamlining Act, is a concurrent review behind the counter of all 3 departments, Engineering, Planning and Building.

The average permit issuance timeframe is about 3-1/2 months, in total. Please review the City Matrix provided by the Tenant Coordinator for more details.

Information about a Commercial Express Review is available at this link: <http://www.walnut-creek.org/departments/community-and-economic-development/the-permit-center/commercial-express-review/>. This process is only available to Tenants not doing any work to the storefront, are under 10,000sf and the valuation is under \$100,000. Please inquire with your Tenant Coordinator to see if this is an option for your project.

Any submittals made to the City of Walnut Creek must include a Landlord approval stamp. The City will not accept any submittals without it.

### **SPECIAL INSPECTIONS FORM**

Structural steel, welding, and high strength bolting require a special inspection form, submitted by a structural engineer, to certify the integrity of the installation.

Please inquire with your Tenant Coordinator for more information on the document.

### **Sign Permit**

Sign Permits are required for exterior signage only. It will be a deferred submittal from the Building Permit and takes approximately 4-8 weeks to receive. A landlord stamp must accompany the sign drawings for the Sign Permit Application to be accepted by the City.

Please review the Sign Criteria Manual for more information on the Master Sign Program that is in place at Broadway Plaza.

### **Fire Department Submittal**

Submittal to the Contra Costa County Fire Department is required of all plan submittals. This is in addition to the submittal the fire sprinkler vendor will make later. This should be done the day before (or the same day) as the Building Department submittal. The City Building Department will not issue a building permit without first seeing approval from the Contra Costs County Fire Department. Contact the Fire Department for submittal Guidelines. Review time is roughly 2-6 weeks depending on the CCCFD's workload.





# OPERATIONS AND UTILITIES

## OPERATIONS

The following is a brief overview of the site infrastructure available during retail operations and construction.

### **PARKING**

Contractor Parking is not available at any surface lots, spaces or garages at Broadway Plaza. Monthly parking passes for the Parking Garages are available for purchase at the time of Contractor Check-In through the Mall Management Office (Parking Services). The cost is \$50/month per vehicle and can be renewed as necessary, so long as space allows. This is subject to change without notice.

### **DELIVERIES**

There are no loading docks at Broadway Plaza. All deliveries are to be done off of Broadway Plaza Street or via loading areas in Parking Garages A, C and D. Please see Mall Management for days and times that deliveries are allowed.

Any construction material that requires a drywall dolly, a pallet jack or a scissor/boom lift must be coordinated with Mall Management. The brick pavers must be protected with a minimum of 1" plywood to create a "walk path" for the length of the delivery path. Plywood is not provided by the mall and any deliveries made without protection are subject to fines outlined in the Construction Rules and Regulations document.

### **TRASH**

There is no onsite area or space available for onsite contractor construction debris boxes, open top containers during any tenant demo's and build outs. All construction sites must work with a mobile trash hauler that can conduct routine or as needed haul offs to remove waste from the job site. Please plan to have waste removal bid based on this information. The City of Walnut Creek requires contractors to participate in a Waste Management Program called GreenHalo. Please be sure your selected waste hauler is aware of this.

Mall dumpsters and compactors on the property are for Tenant use only ; not job sites under construction. Any contractors seen violating this designation are subject to fines outlined in the Broadway Plaza Construction Rules and Regulations packet.

## SITE UTILITIES AND SERVICES

The following is an overview of the utilities and services typically available for in-line retail spaces. Please refer to lease language for any agreed upon changes that may overwrite these typical service provisions. It is the Tenant's responsibility to verify existing conditions and comply with all applicable codes and standards for all Technical systems.

### **I. ELECTRICITY**

Tenant shell spaces typically provide an empty conduit to a main power source. The main power source available for Tenant connections will be 277/480v, 3 phase, 4 wire available from the nearest electrical room.

Electrical use is sub-metered and charged by the Landlord in Buildings 1, 2, 3, 4, 5, and 6. A separate account with an electrical utility company is not required.

Buildings C1, C2 and D2 may be separately metered inside the space. Please field

verify the condition for spaces in this building. In these instances, direct account set up by the Tenant with PG&E (Pacific Gas & Electric) is required.

### **II. DATA AND COMMUNICATIONS**

Tenant shell spaces typically provide a conduit with pull string to nearest Granite rack.

Phone and internet services are provided on-site through Granite Grid.

Tenants must coordinate directly with Granite Grid to set up their data utility.

Other data providers do not have a right of access agreement and are not permitted access to the property.

### **III. SPRINKLER SYSTEM**

Tenants are responsible for contracting with the Landlord's required sprinkler vendor to adjust any existing grids, or install new if none exist, and tie into the main system.

### **IV. FIRE ALARM SYSTEM**

Tenants are responsible for contracting with the Landlord's required fire alarm vendor to install all code-required alarm, horns, strobes, conduit within the Tenant's space to tie into the Landlord's main fire alarm panels.

### **V. WATER**

Tenant shell spaces typically provide domestic cold water stubbed into the space. Size and location of the pipe varies per space. Spaces also typically provide a sanitary line stubbed into the space or located under the floor slab. Size and location of the line varied per space.

Water use is metered and charged by the Landlord for retail Tenants. A separate account with a water utility company is usually not required, unless Tenant is a food use.

### **VI. HVAC**

All tenants spaces are on the own HVAC systems and Buildings 1, 2, and 3 have outside air ducted into their spaces from a shared building line, as well as a return duct. Tenants are responsible for all installation and maintenance of HVAC units serving their space.

### **VII. GAS**

Gas utility is not available for in-line retailers.

Some food spaces have gas lines stubbed into their spaces and account set up and meter setting is done directly with EBMUD.



# CONSTRUCTION > PRE-CONSTRUCTION / CLOSE OUT

## CONSTRUCTION

The following is a brief overview of the construction process and requirements for a tenant build outs:

### WORKING ENVIRONMENT

In conjunction with compliance with the Labor Contracts provision in the Lease, Tenant, at Tenant’s sole cost and expense, must ensure the following based on the square footage of the Premises:

2,500 sf - 49,999 sf	Tenant’s general contractor must be a signatory to the Carpenters Master Agreement of Northern California (“CMANC”) in effect at the time of commencement of construction of the Premises.
1,500 sf - 2,499 sf	All sub-contractors used for any carpentry trade work (framing, drywall, millwork, etc.) must be signatories to the Carpenters Master Agreement of Northern California (“CMANC”) in effect at the time of commencement of construction of the Premises.
Under 1,500 sf	No specific additional requirement.

Please direct all union related questions to the local carpenter’s union rep listed below.  
 Kyle Swarens  
 (510) 932-0267  
[kswarens@nccrc.org](mailto:kswarens@nccrc.org)

### I. PRE-CONSTRUCTION

Prior to any construction commencement, the contractor’s site superintendent is required to meet with the Landlord to review property construction requirements, submit construction documentation, and provide payment for property construction fees.

Required pre-construction documents include:

1. Landlord Approved CONSTRUCTION DOCUMENTS
2. Contractors Rules & Regulations to be completed and signed in full
3. Approved GC Certificate of Insurance
4. A copy of the Building Permit issued by the City
5. General Contractor’s state license
6. Construction Progress Schedule
7. Subcontractor List (include associated trade, contact name and phone number)

The Landlord will send a Preparedness Letter detailing the fees required for collection prior to scheduling this pre-construction meeting.

### II. INSPECTION PROCESS - CITY OF WALNUT CREEK, BUILDING DEPARTMENT

There are a total of 6 final inspections needed for Certificate of Occupancy.

1. Fire Sprinkler Final (CCCFD)
2. Fire Alarm Final (CCCFD)
3. Fire Life Safety Final (CCCFD)
4. Planning Inspection (scheduled directly with the City Planner assigned to the project)
5. Engineering Inspection (scheduled directly with the Engineering Department)
6. Building Final (Building Inspector will not issue final approval until all 5 previously mentioned finals are completed)

It is the General Contractor’s responsibility to schedule all inspections.

### III. CLOSE OUT

At construction completion, the Landlord will meet with the superintendent to perform a punch list walkthrough. The created punch list is required to be completed to the Landlord’s satisfaction in order to close out the construction project.

To complete closeout, the following documents are required to be submitted:

1. Copy of Certificate of Occupancy or equivalent and Proof of Passing Final Inspections.
2. Final list of Subcontractors (please make any changes or additions from the list supplied at pre-con)
3. Unconditional Lien Waivers from all contractors, subcontractors and materials and service suppliers.
4. Notarized Affidavit from General Contractor stating that no liens exist as a result of Tenant’s work.
5. Notarized AIA documents G702 & G703 (if the job is \$100,000.00 or more) / General Contractors Final Billing
6. AABC or NEBB Certified Air Balance Report
7. As-Built Documents (record set of what was constructed at the site, including Architectural, Structural, Mechanical, Plumbing, Electrical, Fire Protection, etc.) Electronic (PDF) format preferred.
8. Utilities Form

# SUBMITTAL CRITERIA CONTENT OVERVIEW

6.1

## CONSTRUCTION DOCUMENTS

CRITERIA FOR ARCHITECTURAL DESIGN REQUIREMENTS FOR RETAIL STOREFRONTS AND INTERIORS.

6.2

## SIGNAGE DRAWINGS

CRITERIA FOR PRIMARY AND SECONDARY STOREFRONT SIGN DESIGNS.

**The Submittals Criteria highlights the Landlord review process and drawing submittal requirements to ensure a quick and smooth drawing review for your design and CONSTRUCTION DOCUMENTS.**

Tenant construction and signage drawings must be reviewed and Approved by the Landlord before the drawings can be submitted for permit. Permits from the local Municipality are required for all incoming Tenant construction and signage.

It is always the Tenant's responsibility to ensure:

- Compliance with the Lease document.
- Field verification of conditions and dimensions.
- Discrepancies between the drawings and the as-build conditions.
- Coordination with trades to ensure compliance with all local and national codes.

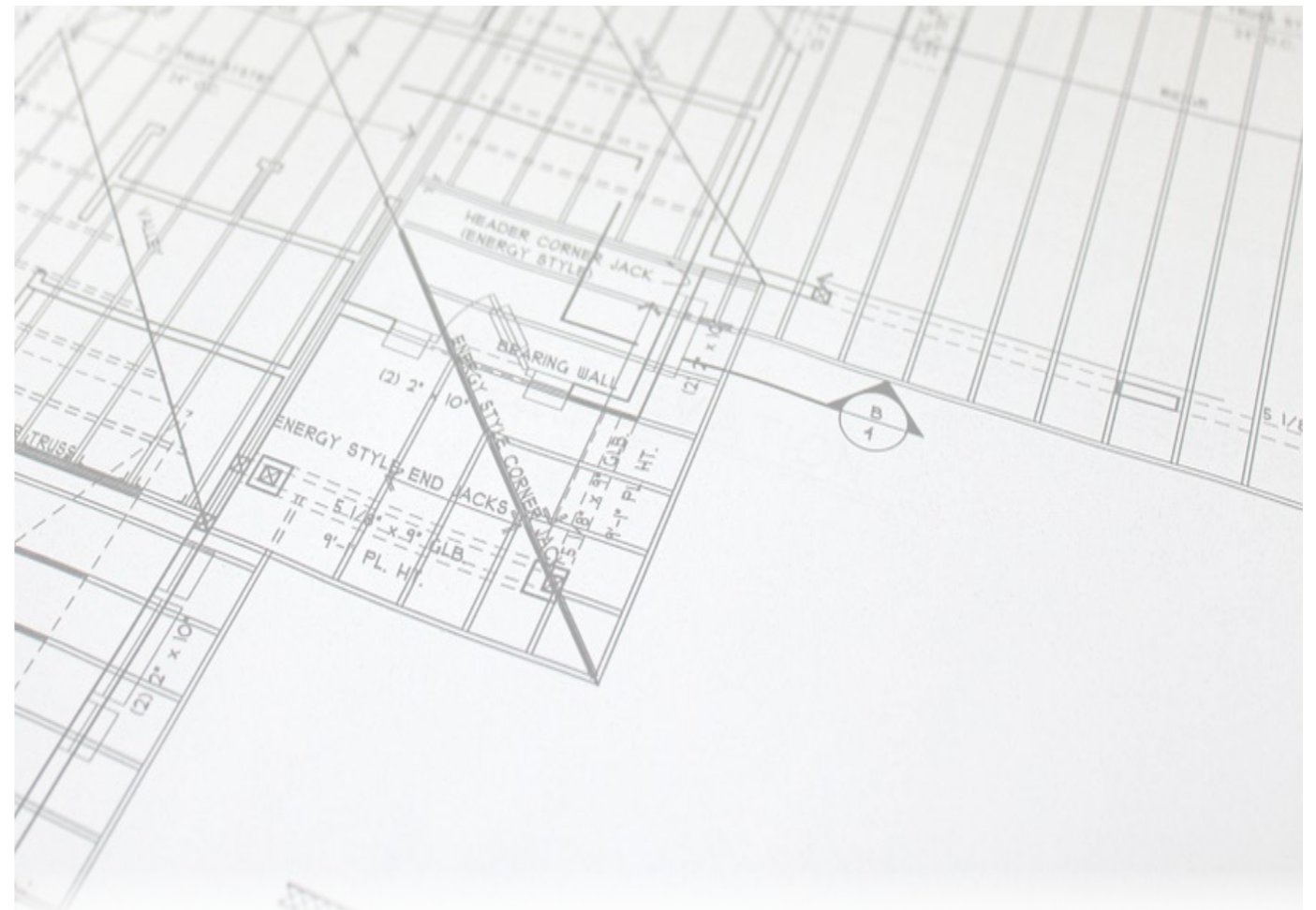



# CONSTRUCTION DOCUMENTS > PROCESS & TIMELINE

## DRAWING REVIEW PROCESS

Drawing reviews are required to be submitted in two stages for Landlord review; Preliminary and final CONSTRUCTION DOCUMENTS. Preliminary drawings are required to ensure the design process moves quickly by ensuring that all Criteria requirements are understood and adopted early in the design. This helps ensure an expedited review of the final CONSTRUCTION DOCUMENTS.

## REVIEW TIMELINE

Step	Action	Time Period
1	Tenant submits preliminary design.	Required 20 days after Lease Execution or 10 days following previous submittal disapproval.
2	Landlord Approved Preliminary Design.	15 days after confirmed completion of Step #1.
3	Tenant submits final construction drawings.	Required 20 days after Tenant Coordinator approval at Step #2.
4	Landlord Approves final documents.	15 days after completion of Step #3.
5	Tenant submits drawings for permit. (If applicable)	5 days after confirmed completion of Step #4.
6	Tenant responds to any requests from or comments by permitting jurisdiction.	5 days.
7	Upon permit review approval, Tenant pays all fees and logs out permit.	5 days.



## PRELIMINARY DESIGN SUBMITTAL

The Preliminary Document review process will evaluate all the criteria discussed in this manual, including overall three-dimensional form, degree of design uniqueness and identity, use and detailing of materials, colors and lighting, and integration of signage and graphics.

Submittals are to provide the reviewer with a clear understanding of proposed design concepts.

The submission must be complete in order to fairly evaluate the proposal and prevent continuation of work on an unacceptable design.

Tenant shall submit to Landlord at [tcsantamonica@macerich.com](mailto:tcsantamonica@macerich.com) electronic PDF files of the following:

- **Color and Material Sample Board**  
Include actual samples of all Tenant colors and materials visible to the public, on a digital sample board. Clearly label all materials and reference to floor plan elevations.
- **Perspective and/or Photo Image(s)**  
Colored perspective rendering and/or prototypical photo images of the proposed storefront, including graphics and signage.
- **Cover Sheet**  
Include: Name of Tenant, name of Mall or Center, space number, Applicable Codes, Building Type and Occupancy Type, Leased square footage, and Key Plan.
- **Floor Plan**  
¼" Scale Minimum showing: Entire lease dimensioned space with room names, floor finishes, casework and fixture locations.
- **Reflected Ceiling Plan**  
¼" Scale Minimum showing: Lighting design, including fixture types and locations, signage, access panels, Overhead projections such as light coves and fascia systems, and Entrance.
- **Sections**  
1" Scale Minimum showing: Entry, Display windows and fascia, Sign integration into storefront design.
- **Storefront Elevations**  
½ Scale Minimum showing: Exterior views - front and sides, Signs, graphics, logos.

**Copies of all drawings are to be sent to the Tenant Coordinator via email.**

A physical sample board is also required, mounted on foam core or card stock to be sent in coordination with your Tenant Coordinator.

## **FINAL DRAWING SUBMITTAL**

After Preliminary Drawing Approval, it is critical to quickly complete and submit Final CONSTRUCTION DOCUMENTS for Landlord review.

If any questions arise from the Tenant's interpretation of the design and criteria information, the Tenant shall assume all responsibility for clarification by written request to the Tenant Coordinator. The Landlord plan review and approval process is independent of local permitting for construction. The Tenant is responsible for procurement and compliance with local, state and federal codes and requirements.

Tenant shall submit to Landlord at [tcsantamonica@macerich.com](mailto:tcsantamonica@macerich.com) electronic PDF files of the following:

- **Responsibility Schedule**  
Any work, which is the Landlord's responsibility, must be listed clearly on a responsibility schedule on the cover sheet.
- **Cover sheet**  
Include a Key Plan, Name of Tenant, name of Mall or Center, space number and location leased premises within Mall or Center, Applicable codes, building type and occupancy type, Leased square footage, Responsibility schedule, and Drawing index.
- **Floor Plans**  
¼" Scale Minimum showing: Entire lease space with room names, Floor finishes, casework and fixture locations, and Demolition plan.
- **Reflected Ceiling Plan**  
¼" Scale Minimum showing: Complete lighting design, including fixture types and locations, signage, access panels, Overhead projections such as light coves and fascia system, Entry, Connection to Landlord's work, Tenant's framing and/or additional structure showing freestanding from Landlord's structure.
- **Sections**  
1" Scale Minimum showing: Entry, Display windows and fascia, Sign integration into storefront design, Connection to Landlord's work, Tenant's framing and/or additional structure showing freestanding from Landlord's structure.
- **Interior Elevations**  
¼" Scale Minimum showing: All sales floor interior views, Built-in casework, signage, and display systems.
- **Storefront Elevations**  
½" Scale Minimum showing: Exterior views - front and sides, Signs, graphics, logos, Landlord neutral piers, Storefront finishes (to be referenced to finish schedule)
- **Architectural Details**  
½" Scale Minimum.
- **Door Schedule**  
Include floor transition details and anti-theft security system details.
- **Details, Catalogue Cut Sheets, and Fixture Finishes**
- **Finish & Color Schedule**
- **Include CAD/DWG drawing files as part of drawing submission including: Demo plan, Floor plan, MEP plans, and Life safety/ Egress Plans. Please include any background drawings that are necessary to view these files as a comprehensive whole.**

**Copies of all drawings are to be sent to the Tenant Coordinator via email.**





## **FINAL DRAWING SUBMITTAL - ENGINEERING DRAWINGS**

The Landlord does not review for mechanical, electrical, plumbing, or structural design, nor does the Landlord accept responsibility for the Tenant's adherence to governing codes.

Tenant shall submit to Landlord at [tcsantamonica@macerich.com](mailto:tcsantamonica@macerich.com) electronic PDF files of the following engineering drawings included in the final drawing set:

**Copies of all drawings are to be sent to the Tenant Coordinator via email.**

### **I. MECHANICAL DESIGN DOCUMENTS**

- Make, type, and performance of all equipment.
- Sign and seal by a Licensed Engineer in the state where the Shopping Center is located.
- Calculations showing the heating and cooling required, including transmission and ventilation losses in the space, and heat and cooling provided for the ventilation supply, and exhaust required for the space. Calculations must be performed in accordance with the latest ASHRAE standards and tabulated in a concise, orderly manner.
- Temperature control system data showing make, control, and energy management systems.
- Exhaust system layout including CFM and equipment specifications.
- Reflected ceiling plan showing HVAC equipment.
- Roof plan with equipment locations.
- Structural details for support of all rooftop equipment and equipment suspended from the steel structure.

### **II. PLUMBING DESIGN DOCUMENTS**

- Make, type, and performance of all equipment.
- Sign and seal by a Licensed Engineer in the state where the Shopping Center is located.
- Complete plumbing system design and floor plan for the Tenant space including, but not limited to the toilets, sinks, urinals, drains, hot water heaters, water coolers, grease trap/interceptors and connections into existing water and sewer lines.
- Single line diagram.
- Fixture schedule.
- Water heater detail as applicable.
- Grease trap cut sheets as applicable.

### **III. FIRE PROTECTION / SMOKE EVACUATION DESIGN DOCUMENTS**

- Reflected ceiling plan, with revised sprinkler head locations.
- Design must be City approved before construction

### **IV. ELECTRIC DESIGN DOCUMENTS**

- Sign and seal by a Licensed Engineer in the state where the Shopping Center is located.
- Panel schedules, load calculations, and meter information, if applicable.
- Structural drawings for all equipment that will be suspended from the steel structure.
- Electrical load summary and Title 24 Energy Calculations (for State of California).
- Floor plan depicting equipment locations and branch circuitry.
- Reflected ceiling plan depicting the layout of light fixtures.
- System one line diagrams.
- Lighting fixture schedule.
- Equipment legend.

### **V. STRUCTURAL DESIGN DOCUMENTS**

- Design elements affecting the structure of the base building.
- Alterations, additions, modifications and reinforcements to the base building which shall be required to accommodate Tenant's Work.
- All calculations & details (Include ICBO numbers on all framing details, Seismic bracing details for State of California.)
- All forms required by governmental agencies and Governmental Regulations, fully and properly completed and executed by Tenant.
- Partial structural framing plan showing existing conditions for new and existing rooftop installations and proposed reinforcement, which shall be accompanied by structural engineers' calculations, drawn on a scale of 1/2"=1'0".
- Ceiling, soffits, storefront attachment details to existing base building.
- A letter from a state-registered structural engineer certifying that all new equipment and design elements serving the Premises are adequately supported to carry the new load.



# SIGNAGE DRAWINGS > PROCESS & TIMELINE

## DRAWING REVIEW PROCESS

Sign drawing reviews are required to be submitted in two stages for Landlord review; Preliminary and final CONSTRUCTION DOCUMENTS. Preliminary drawings are required to ensure the design process moves quickly by ensuring that all Criteria requirements are understood and adopted early in the design. This helps ensure an expedited review of the final CONSTRUCTION DOCUMENTS.

## REVIEW TIMELINE

Step	Action	Time Period
1	Tenant submits preliminary design.	Required 20 days after Lease Execution or 10 days following previous submittal disapproval.
2	Landlord Approved Preliminary Design.	15 days after confirmed completion of Step #1.
3	Tenant submits final sign drawings.	Required 20 days after Tenant Coordinator approval at Step #2.
4	Landlord Approves final documents.	15 days after completion of Step #3.
5	Tenant submits drawings for permit. (If applicable)	5 days after confirmed completion of Step #4.



## > SUBMITTAL REQUIREMENTS > PRELIMINARY, FINAL

### PRELIMINARY DESIGN SUBMITTAL

The Preliminary Document review is intended to acquaint the Landlord with the Tenant's signage design intent.

Submittals are to provide the reviewer with a clear understanding of proposed design concepts.

The submission must be complete in order to fairly evaluate the proposal and prevent continuation of work on an unacceptable design.

Tenant's licensed sign contractor shall submit to the Center's Tenant Coordinator electronic PDF files of the following:

- **Perspective and/or Photo Image(s)**  
Colored perspective rendering and/or prototypical photo images of the proposed storefront, including graphics and signage.
- **Storefront Elevations**  
½ Scale Minimum showing: Exterior views - front and sides, Signs, graphics, and logos highlighting sign dimensions and materials.

### FINAL DRAWING SUBMITTAL

After Preliminary Drawing Approval, it is critical to quickly complete and submit Final CONSTRUCTION DOCUMENTS for Landlord review.

If any questions arise from the Tenant's interpretation of the design and criteria information, the Tenant shall assume all responsibility for clarification by written request to the Tenant Coordinator. The Landlord plan review and approval process is independent of local permitting for construction. The Tenant is responsible for procurement and compliance with local, state and federal codes and requirements.

The Landlord does not accept responsibility for the Tenant's adherence to governing codes or verification of job site conditions.

Tenant's licensed sign contractor shall submit to the Center's Tenant Coordinator electronic PDF files of the following:

- Elevation of the storefront including signage and graphics; showing all doors, architectural features, etc., and fully detailed/dimensioned sections and details through the storefront.
- These fully detailed and dimensioned drawings shall be drawn to scale as noted:
  - Storefront Plan, Elevation and Sectional views at 1/2 inch scale.
  - Details of the Signage at 1/2 inch scale or larger.
  - Storefront Signage at 1/2 inch scale.
- Letter style and typeface specifics.
- Color and finish qualities of all portions of signage.
- Material specifications and thickness.
- Transformer specifications, including input and output voltage of transformers. PK housing, (or other UL approved insulating sleeve approved by Landlord and local building codes), is required for all through wall penetrations and must be indicated on the sign shop drawings. Wiring specifications.
- Locations of service switches, access panels and transformers. NONE of these items shall be visible to the public from any portion of the Mall.
- Neon tube specifications, including color and dimension (in mm) of tubes to be used.
- Type of lamps.
- Mounting hardware.





# ADDENDUM LINKS

This Addendum contains links to supplemental documents of specific requirements and information. These documents are considered part of the Tenant Criteria Package. Clicking the links below will navigate to the described documents. It is the responsibility of the Tenant, its contractors, subcontractors, architects, engineers, employees, and agents to comply with terms of the Tenant Criteria, Addendum included.

## **GLOSSARY**

### I. [GLOSSARY OF TERMS](#)

Defines commonly used terms for clarity.

## **DESIGN ADDENDUM**

### I. [BROADWAY PLAZA SUSTAINABILITY HANDBOOK](#)

Guide to encourage energy efficient, sustainable design.

### II. [UNIT UTILITIES AS BUILT CHECK LIST](#)

Helpful checklist for reference during a site survey.

### III. [SPECIALTY LEASING CRITERIA](#)

Design requirements for temporary Tenant's buildout and signage.

## **BARRICADE ADDENDUM**

### I. [BARRICADE GUIDELINES](#)

Guide to installing and activating construction barricades with graphics.

## **CONSTRUCTION ADDENDUM**

### I. [CONTRACTOR RULES AND REGULATIONS](#)

Document detailing the rules and regulations Tenant contractors must adhere to during their construction. This document must be reviewed and signed by the Site Superintendent overseeing the Tenant build out.

### II. [HOT WORK PERMIT](#)

Required form to submit when construction required hot work.

### III. [PUNCH LIST](#)

Reference Landlord Punchlist that that Landlord will use to inspect and confirm completion of Tenant construction.

## **SIGNAGE**

### I. [BROADWAY PLAZA MASTER SIGN PROGRAM](#)

