



THE SHOPS AT  
*Atlas Park*

TENANT  
CRITERIA

MACERICH®

# VISION STATEMENT

## Welcome to The Shops at Atlas Park.

It is our vision and mission at Macerich to distinguish ourselves through superior performance in retail development and continuous improvement of our portfolio, to meet the changing needs of our customers and the retailers we serve. Our commitment is to furnish a well-designed, well-maintained and well-marketed retail environment, capable of maximizing traffic and sales.

We are pleased to become partners with retailers, striving for the same goals. We are ready to facilitate communication and share our expertise with you to complete your store within expected timelines.

These Criteria act as a guide for the design of all work by Tenants in conjunction with the provisions of the Tenant's lease with the Landlord. Tenants are encouraged to express their own unique design statement within the parameters of the Design Criteria as outlined in this manual.

National and regional "standard" Storefront concepts are respected to the extent that they meet the Design Criteria. However, Tenants should be aware that some concept modifications might be necessary to comply with the Center's Criteria.

The same is true for proposed designs that are overly similar to a neighboring Tenant's Storefront design. We wish to make the Mall as diverse and interesting as possible and enable each Tenant to make a singular statement with their design.



# CRITERIA MAIN CONTENTS

**1.0** **INLINE**  
CRITERIA FOR ARCHITECTURAL, SIGNAGE, AND TECHNICAL DESIGN FOR INLINE RETAIL LOCATIONS.

**2.0** **FOOD**  
CRITERIA FOR ARCHITECTURAL, SIGNAGE, AND TECHNICAL DESIGN FOR INLINE FOOD, FOOD COURT/HALL, AND RESTAURANTS.

**3.0** **KIOSK**  
CRITERIA FOR THE DESIGN AND CONSTRUCTION OF RETAIL AND FOOD KIOSKS.

**4.0** **BUILDING DETAILS**  
ARCHITECTURAL DETAILS, REQUIREMENTS AND REFERENCE PHOTOS BASED ON STORE LOCATION.

**5.0** **DESIGN INSPIRATION**  
SUGGESTED DESIGN MOTIFS AND INTRO TO KEY DESIGN ELEMENTS.

**6.0** **PROPERTY INFO**  
PROPERTY LOCATION, CONTACTS, UTILITIES OVERVIEW, OPERATIONS, AND LOCAL PERMITTING INFO.

**7.0** **SUBMITTALS**  
REQUIREMENTS TO SUBMIT CONSTRUCTION DRAWINGS, RENDERS, SIGN DRAWINGS, AND MATERIAL BOARDS.

**8.0** **ADDENDUM**  
SUPPLEMENTAL DESIGN AND CONSTRUCTION REQUIREMENTS AND DETAILS PROVIDED AS LINKS TO EXTERNAL DOCUMENTS.

**i** **INTERACTIVE NAVIGATION**

This Criteria is an interactive document. You may tap or click the top Navigation Bar or the Side Content Bar to navigate directly to that section.

## This page serves as a hub to the various sections included in this Criteria.

The sections in this Criteria break down the key categories of information to understand the design and construction requirements to incorporate a successful retail experience. Refer to the overviews included in the left side bar to learn more about the content included in each section.

It is the responsibility of the Tenant, its contractors, subcontractors, architects, engineers, employees, and agents to comply with terms of the Tenant Criteria, including the supplemental documents included in the Addendum.

The intent of this Criteria manual is to:

- Accelerate the leasing process by providing quick answers to questions about specific requirements.
- Establish the design expectations and technical requirements.
- Establish a coherent design by carefully curating and integrating within the Center.
- Guide the design standards.
- Answer basic questions about the design and construction process.
- Save time by minimizing design reviews.



# INLINE RETAIL CONTENT OVERVIEW

1.1

## DESIGN

CRITERIA FOR ARCHITECTURAL DESIGN REQUIREMENTS FOR RETAIL STOREFRONTS AND INTERIORS.

1.2

## SIGNAGE

CRITERIA FOR PRIMARY AND SECONDARY STOREFRONT AND WINDOW SIGN DESIGNS.

1.3

## TECHNICAL

CRITERIA FOR TECHNICAL DESIGN ELEMENTS TO ENSURE YOUR STORE CAN INTERFACE WITH THE PROPERTY'S BASE BUILDING UTILITY SYSTEMS.

### SECTIONS OF INTEREST

- BUILDING DETAILS**  
Includes property reference photos and specific Storefront design details.
- PROPERTY INFO**  
Includes information on the Property's building codes, area permitting, and required contractors.
- SUBMITTALS**  
Outlines requirements on how and what to compile for submittals to the Landlord for design reviews.
- DESIGN INSPIRATION**  
Provides visual inspirations for design aesthetics.

**The Inline Retail Criteria provides key technical information and design requirements to ensure your store enlivens the consumer experience and interfaces with the Center.**

The Tenant and the Tenant's Architect assume the following important obligations:

- Fulfill the intent of the Criteria both in concept and in detail.
- Determine and respond to the actual physical conditions of the Tenant's location.
- Maintain and enhance the high standards of quality established in the construction of the Center.
- Ensure the quality of execution of all design material, finish, and detail concepts in the construction of the Tenant's improvement.
- Provide the required detail at all transitions from Tenant Storefront to neighboring Storefronts, as well as to the base building.



# DESIGN CRITERIA

## ☐ STOREFRONTS

- ☐ ENTRY
- ☐ STOREFRONT HEIGHTS / NEUTRAL PIER / AWNINGS / CONSTRUCTION

## ☐ DESIGN CONTROL AREA

- ☐ DESIGN REQUIREMENTS / WINDOW DISPLAY / PROHIBITED DESIGN ELEMENTS

## ☐ MATERIALS

- ☐ GLAZING / DECORATIVE GLASS
- ☐ WOOD / STONE / PLASTER
- ☐ METAL / LEATHER
- ☐ WALLCOVERINGS / SOLID SURFACE
- ☐ PAINT / FAUX FINISHES / FABRIC / TILE

## ☐ INTERIORS

- ☐ LIGHTING / FLOORING
- ☐ CEILING / WALLS & PARTITIONS
- ☐ EGRESS DOORS / RESTROOM

## SECTIONS OF INTEREST

- ☐ BUILDING DETAILS  
Includes property reference photos and specific Storefront design details.
- ☐ PROPERTY INFO  
Includes information on the Property's building codes, area permitting, and required contractors.
- ☐ SUBMITTALS  
Outlines requirements on how and what to compile for submittals to the Landlord for design reviews.
- ☐ DESIGN INSPIRATION  
Provides visual inspirations for design aesthetics.

**Tenants are encouraged to express the individuality of their brand through excellent design by forward thinking design teams.**

This Design Criteria focuses on standard design details for Tenants to adopt. Atlas Park is a unique center designed to evoke an urban European ambiance. Specific design components and requirements embracing this ambiance are detailed in the [BUILDING DETAILS](#) section.

Macerich's Design team is always excited to partner with Retailers in curating a unique and memorable shopping experience. Our team is available to collaborate on your enticing Storefront designs. The [DESIGN INSPIRATION](#) section is also a great launching point to explore design concepts and methods to engage customers.

- All Tenants must engage a reputable Architect.
- Design drawings must all be reviewed and approved by the Landlord.
- All design elements and finishes must adhere to local and national building code requirements.



## > STOREFRONTS

**The Center's success is dependent on the creative design contributed by individual Tenants. It is vital that your Storefront design is integrated with the look and feel of the Center's aesthetic.**

The **BUILDING DETAILS** section includes specific Storefront design requirements based on your store's location. These location based requirements must be incorporated into your Storefront's final design.



## > ENTRY

### ENTRY

Your Storefront entry is a critical design feature to create an invitation to shop. As such all stores must express the entry as an identifiable part of the storefront. The underside of the entry portal soffit shall be finished to match the Storefront.

#### I. SWING DOOR ENTRY

- No door swing shall project beyond the maximum allowable lease line.
- Minimum allowable door height is 9'-0".
- Maximum Storefront opening width is 8'-0".
- All other doors are to be hinged or pivot-type doors. Doors are suggested to be the height of the glazed Storefront.



## > HEIGHTS / NEUTRAL PIER / AWNINGS / CONSTRUCTION

### STOREFRONT HEIGHTS

Storefront heights vary per building and are detailed in the [BUILDING DETAILS](#) section.

### NEUTRAL PIER

Tenants are required to install a neutral pier as requested by the Tenant Coordinator using the detail shown in the [BUILDING DETAILS](#) section.

### AWNINGS

Awnings will be considered on a case by case basis and must conform to the exterior building aesthetic.

- The lowest point of any awnings shall not be less than 8'-0" above the finished grade.
- Awnings soil quickly. It is the Tenant's responsibility to maintain appearance to the satisfaction of the Landlord.

### STOREFRONT CONSTRUCTION

- All Storefront construction shall be self-supported from the floor and independent of the building fascia and bulkhead structure.
- Storefronts may be braced to the overhead structure within the Tenant space.
- Storefronts visible from the upper level must take special care that the tops of the Storefront are finished to match the design.
- All surfaces of any visible projections must be finished to match.
- There are to be no exposed conduits, raceways, access panels, or equipment visible from the upper level.
- Underside of the portal entry must be soffit and finished to match the Storefront.





## > DESIGN CONTROL AREA

**The Design Control Area (DCA) is the zone extending from the storefront lease line to 6'-0" inside your space, including all display windows and retail graphics, display fixtures, signs, materials, finishes, color and lighting fixtures within the area.**

At Macerich, we take special interest in the DCA as an extension of the retail presentation and showcase of the store's merchandising. The intent is to convey excitement, and give the consumer a reason to shop.

Use of a professional Visual Merchandisers is highly encouraged. Design drawings shall have a display layout plan. The layout plan shall have cut sheets for fixture and/or mannequin types and include photographs of any existing Storefronts a Tenant may have that will enhance the layout plan. A rendering is required if photographs are not available.

Stores with both interior and exterior presence must activate both DCA areas. Tenants are encouraged to maintain open visibility into their store to draw in Customers.



# > REQUIREMENTS / WINDOW DISPLAYS / PROHIBITED ELEMENTS

## DESIGN REQUIREMENTS

- Ceiling must be a hard surface.
- Lighting fixtures must be consistent with the character of the Storefront design.
- Recess all lighting fixtures.
- A minimal profile track lighting system matching the color of the ceiling plane is allowed.
- Hard bases on the walls are required, including any permitted pop out areas.

## WINDOW DISPLAYS

Displays should be deliberate and integrated into the Storefront. Modulation of display systems and built-in architectural components will reinforce the design.

- Display cases must be adequately lit and ventilated.
- Digital monitors are permitted within 10'-0" behind glazing if integrated into the design and approved by Landlord. Coordinate with Tenant Coordinator for exterior applications and to confirm code or local requirements.

## PROHIBITED DESIGN ELEMENTS

- Track lighting is not permitted in the DCA.
- Temporary signs for sales or clearances shall not be hung in the DCA or affixed to the glass inside or outside.
- No pegboard, slat wall or metal shelving of any kind may be placed in or extend into any part of the DCA.
- Security devices or freestanding pedestals are not permitted. They must be integrated and concealed.
- Carpet, vinyl or rubber materials of any sort will not be permitted within the DCA.
- Exposure of incandescent bulbs and/or fluorescent tubes are not allowed.



## > MATERIALS

As an important aspect of presenting the Tenant's unique brand image, finish materials are to be composed, articulated and executed in a creative and quality manner.

All materials and applied finishes on the Storefront are to be high-grade, durable, non-corrosive and code compliant. They are to be maintained by Tenant at the Tenant's expense. All materials and finishes are subject to Landlord approval, and the inclusion of natural materials is encouraged.

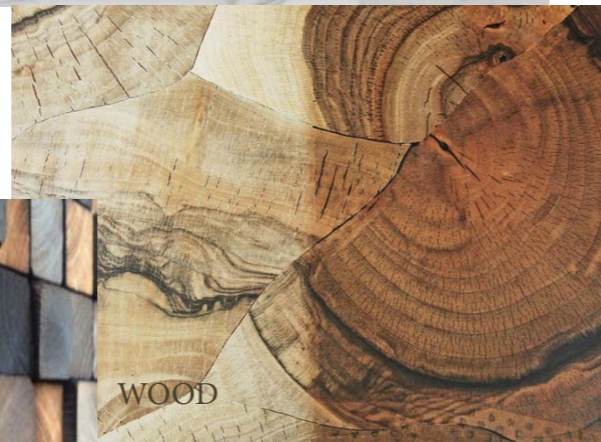

# > GLAZING / DECORATIVE GLASS

## GLAZING

Storefront glazing, particularly clear glazing, is a key component to establish design character and create an invitation for the customer to visit.

- A minimum of 60% of the Storefront is to be display windows with clear glass.
- Reflective glass (including extensive use of mirror) and/or tinted glass is not permitted on Storefronts or in the Storefront entry zone.
- Tinting or films applied after the glass is installed is prohibited.
- All glass shall be tempered. Glazing must be a minimum of ½" thick, and large panes of glazing must be of sufficient thickness to meet code and be properly supported.
- Tenants may be required to provide seismic clips to stabilize tall expanses of glass. Silicone sealant at glazing joints is not permitted.
- Butt-joint glazing is encouraged for show windows that in-fill larger Storefront forms. Glass shall be clear polished plate or tempered glass as required by code.
- Window mullions are required to meet all material and finish standards.
- Decorative glazing such as colored, beveled, sandblasted or etched glass may be used to create accent pattern and interest. Decorative glazing can be used as an accent, but must meet all material standards.



## DECORATIVE GLASS

Decorative glass may be considered to provide a unique feature to the storefront.

- In frame-less assemblies, glass panel joint details edges must be polished, ground or chamfered. Glazing channels at corner conditions must be mitered.
- All exterior glazing units must have a solar heat gain coefficient (SHGC) of not more than 0.27 and a U-value of not more than 0.28.
- Exterior glass must be a minimum of 1" insulated, low E units. 0.27 and a U-value of not more than 0.28.



## > STONE / PLASTER / DECORATIVE GLASS

### WOOD

Wood material can be used for Storefront construction but must comply with all local and national code requirements.

- Applications of painted or stained wood may include window frames, decorative trim, molding and solid areas, such as decorative bulkheads. In some cases, it may be used for larger architectural elements, such as columns and entablatures.
- Wood paneling and plank construction are not acceptable unless presented in a highly imaginative concept and approved by the Landlord.
- Wood specified for interior Storefronts must be kiln dried, mill quality hardwood and must meet local flame spread requirements (Class III 76-200), as well as comply with all code requirements.
- Painted wood must have a shop quality enamel finish. Wood without a paint finish must receive a clear, preservative sealant.
- A mock-up of the materials, colors, textures, or application may be required at Landlord's discretion.

### STONE

Granite, marble, limestone, travertine, slate, adoquin and other natural stone materials may be used for Storefront applications.

Stone may be polished, unpolished, sandblasted, flamed, honed, split-face or carved.

- Natural stone must be protected against staining and discoloration by means of sealers appropriate to the material.
- Craftsman-like attention to detail is required at all connections and transitions to other materials, and we recommend utilizing metal reveals for a clean finish.
- Corner and edge details must prevent visible unfinished edges. Exposed edges must be quirk mitered, chamfered or polished to match adjacent surface finish.

### PLASTER

Cement plaster (stucco) and Venetian plaster finishes may be considered for limited Storefront applications.

- Apply an even texture of light dash, sand or smooth finish.
- Plaster or stucco should not be the primary Storefront material. Finishes should be used in combination with other high quality materials.



## > METAL / LEATHER

### METAL

Metal panel may be used to provide alternate texture on a portion of the Storefront.

- High quality is expected for all metal applications, including careful finishing and quality fastener detailing.
- Metals may include: shop-painted aluminum and steel, stainless steel, solid brass, bronze, pewter, or enamel coated steel, and may be used for hardware, trim and panels when well designed and detailed.
- The following notes on metal material details must be called out on the submitted drawing set:
  - Minimum 1/2" thick fire-rated plywood or other solid substrate is required behind all metal panels.
  - Minimum 18 gauge metal panels are required.
  - All seams between metal panels must be identified on the storefront elevation and must be properly addressed during design review process.
- The following metal surface imperfections are not permitted and must be sured immediately:
  - Oil canning (resulting from light reflection on an uneven or buckled surface)
  - Scratches
  - Warps, dents, occlusions
  - Visible seams or other imperfections
- Reveals, turn-in seams, welding or similar must be specified and detailed for approval. Metal panels will not be allowed to directly come into contact with adjacent panel or other materials.
- No visible fasteners are permitted.
- Lap joints and seams must be even, straight, and concealed when possible. Outside corners are to be mitered or continuous break shaped.
- Sealants on natural metals are required to prevent tarnishing and must be maintained by Tenant at Tenant's expense.



### LEATHER

The use of leather "tiles" for vertical application can add a level of depth and texture to the Storefront. However, these tiles should not be used at an elevation that can be reached by the general population due to the delicate finish and to prevent damage over time.

- The Landlord recommends keeping the use of leather tiles on the Storefront above 7'-0" AFF.

## > WALLCOVERINGS / SOLID SURFACES

### WALLCOVERINGS

Wallcoverings can add depth and texture to Tenant Storefronts, but need to be applied accordingly based on the durability of the product.

Vinyl, Paper, or Fabric Wallcoverings are not considered durable and are expressly prohibited in the use of Tenant Storefronts.

- Any wallcoverings located at pedestrian level (below 7'-0" AFF) must be extremely durable and rated by the manufacturer for high traffic use.
- Any wallcoverings located above pedestrian level (higher than 7'-0" AFF) must be durable and washable for maintenance purposes.
- Removable/repositionable wall coverings are not permitted for Storefront use.
- All wallcovering applications must appear seamless and be securely affixed with commercial grade adhesive rated for high traffic use covering the entire back of the product.
- All maintenance of wallcoverings is by Tenant. No peeling, bubbling, or other separation of the wallcovering from the applied substrate is permitted to remain, and is the responsibility of the Tenant to repair in a time frame deemed acceptable by the Landlord.



### SOLID SURFACE

The use of large format solid surface panels can effectively mimic luxury materials in places where cost may be an issue (IE: Caesar Stone or Cambria), or to provide even, diffuse lighting elements in the Storefront (IE: Lumicor or 3Form).

- All solid surface products must be rated for heavy duty commercial applications – residential quality products are not permitted.
- Joints, flat seams, and corner conditions of solid surface materials must be tight and seamless.
- All visible edges must be finished to the same level and quality as the front face of the material.
- If the body of the product is not consistent throughout, a mitered corner detail is required to keep the presentation clean.
- All corners and edges must be eased for safety purposes.
- No adhesive can be visible in the final application.



## > PAINT / FAUX FINISHES / FABRICS / TILE

### PAINT

- Surfaces should be maintained as an even and durable surface finish, at all times.
- Any paint application should show uniformity without evidence of touch-ups or batch variation.
- Paint should be colorfast, and well executed to prevent lap marks, brush marks, or poor coverage.
- Surfaces and materials shall be prepared and staged correctly to avoid problem conditions such as poor adhesion, sagging, chipping or flashing.
- Painted metal surfaces are not allowed unless there is a factory applied finish of baked enamel or power coat treatment.
- Painted gypsum board is not permitted on the Storefront.
- Painted MDF may be used with a finish process of 1 coat primer, 2 coats finish (sprayed and sanded between each step). Minimum thickness of the MDF is 3/4" on Storefronts.

### FAUX FINISHES

Faux finishes may be used at the Landlord's discretion.

- Actual samples of the faux finish must be submitted to the Landlord. Photographs of previous examples are helpful but may not be substituted for an actual sample.
- Faux finishes must be executed by a commercial artisan specializing in that medium.

### FABRICS

- Fabrics shall be commercial grade and tested in accordance with ACT Guidelines.
- Specifics for flammability and four aspects of fabric durability: Wet & Dry Crocking, Colorfastness to Light, Physical Properties, and Abrasion are to be documented for each fabric specified and available for Landlord review if requested.

### TILE

- Tile may be used in diverse applications and is encouraged to introduce light, texture, and graphic quality to a Storefront.
- Porcelain, cermaic, or glass tile in glazed or natural finishes may be used as accents and in limited field applications. Patterns over a large area must be sophisticated and well executed.
- Small intricate mosaic tile may be utilized for detail and accents only.
- Lapped or butt joints are not permitted. Outside cornered must be bull nose edge or special corner trim.
- Grout color should match the background color of the tile so as not to emphasise the grid.





## > INTERIORS > LIGHTING / FLOORING

**The store interior design should emphasize your merchandise and create an exciting experience for the customer.**

It is the Tenant's responsibility to survey, capture and address all existing conditions within the space.

### LIGHTING

Lighting can greatly contribute to the design of a Tenant's store, by emphasizing architectural forms as well as highlighting signage, adding color and visual drama to walls and other design elements. The creative use of dramatic lighting is encouraged at entries, show windows and merchandise displays.

- Fixtures must be positioned to avoid glare directed into public areas. Do not over light.
- Lighting in the DCA is to remain on between 9:00 PM and 9:00 AM, dimmed to a level of 25%.
- Wall sconces or decorative lamping may be used to cast light onto storefront forms, provided that bare bulbs are not exposed and that the finish and form of these fixtures coordinate with the overall Storefront design. Fixture cut sheets are required.
- Sconces shall be commercial grade in quality and size.
- Residential scaled sconces are not acceptable.
- Colors are subject to Landlord approval.
- 2'x2' or 2'x4' prismatic fluorescent lights are not allowed.
- Track lights shall be finished to match the ceiling.
- Strobe, spinner, or chase type lighting is not permitted.

### FLOORING

- Finished flooring is required in the full premises including in the recessed entry conditions and storage areas of the store.
- Hard surface base is required in all sales areas.
- Ensure floor material is durable and non-slip.
- Carpet must be commercial grade and meet local code required fire-proof ratings.
- Exposed concrete floors must be sealed.
- Transitions between flooring and common areas must be flush.
- Tenant is responsible to mitigate any/all ADA issues and clear with the appropriate municipality.



## > CEILING / WALLS & PARTITIONS

### CEILING

- Stores 800 s.f. or less must have a gyp board ceiling, not an acoustic panel ceiling.
- Recessed entry conditions must have a finished soffit matching the storefront.
- Concealed light covers to highlight architectural elements are encouraged.
- Multi-level ceilings are encouraged.
- Gypsum wallboard, concealed spline, decorative patterned ceiling panels, and other “high-tech” materials are encouraged.
- Standard 24” x 48” acoustical panels are not allowed in sales areas.
- Sprinkler heads are to be fully recessed in hard or acoustical ceilings.
- All ceiling material shall be non-combustible. No combustible materials may be used above the finished ceiling.

### WALLS & PARTITIONS

- Demising walls are not designed to accommodate cantilevered or eccentric loads. If Tenant plans to use a demising wall for support of shelf standards, light soffits or heavy attachments, Tenant shall reinforce the wall as required by providing additional steel studs or independent supports for the shelf standards.
- Demising walls and ceiling shall be sound insulated to achieve a minimum STC rating of 50 by Tenants who produce above 80 dB (including but not limited to music stores, arcades, etc.) The Landlord will strictly enforce all Tenants’ right to quiet enjoyment of their Leased Premises.
- Tenant shall protect fire proofed columns and braces with gypsum board, and furr as required.
- The following are required for hair salons, pet shops and all food preparation type Tenants:
  - Walls containing “wet” areas to be constructed of metal studs with water resistant 5/8” type “x” gypsum board.
  - Demising walls of pet shops shall have sheet metal installed on studs, behind drywall, up 3’-0” from floor.
- When Tenant chooses not to install a ceiling within Tenant’s stockroom, Tenant shall extend the partition separating the stockroom from other areas of the store, to the underside of the structure above in order to isolate the stockroom from the sales area attic space. Tenant to verify if this is allowed by code.
- Metal or plastic laminate inserts are required for slatwall. No visible substrate at slats.
- Recessed wall standards are permitted.
- No open shelving with visible brackets or surface mounted systems are allowed.



## > EGRESS DOORS / RESTROOM

### EGRESS / SERVICE DOORS

- All secondary exit doors shall be backset so that the door does not swing into the corridor, or exit passageway.
- Doors entering a common exit passageway or corridor shall be labeled with the Tenant name and space number.

### RESTROOM

- 3" Floor drain and cleanout are required.
- Each restroom must have an exhaust system.
- A waterproof membrane beneath the finish floor surface up to a height of 4" along all walls is required.
- Floor finishes in toilet rooms shall be ceramic tile with a coved 6" base. Tenant is required to provide a waterproof membrane beneath the finish floor surface up to a height of 4" along all walls.
- Toilet room walls and ceiling shall be constructed of metal studs with water-resistant 5/8" type "x" gyp board.
- A water shut-off valve is required at eye level.



# SIGN CRITERIA > CONTENTS

## ❑ PRIMARY SIGNAGE

- ❑ CONTENT / DESIGN ELEMENTS
- ❑ PLACEMENT / CONSTRUCTION / DIMENSIONS
- ❑ LIGHTING / DESIGN & FABRICATION / IDENTIFICATION

## ❑ SECONDARY SIGNAGE

- ❑ WINDOWS / THRESHOLD
- ❑ AWNINGS / BLADES
- ❑ PROHIBITED ELEMENTS

## SECTIONS OF INTEREST

- ❑ BUILDING DETAILS  
Includes property reference photos and specific Storefront design details.
- ❑ PROPERTY INFO  
Includes information on the Property's building codes, area permitting, and required contractors.
- ❑ SUBMITTALS  
Outlines requirements on how and what to compile for submittals to the Landlord for design reviews.
- ❑ ADDENDUM  
Includes additional info on exterior signage requirements.

## Storefront signs are vital to the successful function of the Center.

The goal of this Criteria is to produce a colorful collage of signage that tastefully informs, delights, and stimulates the shopper.

All sign materials must be consistent with the design theme, enhancing the storefront and evoking a positive retail image.

Due to the variety of architectural treatments within the Center, each Storefront sign will be carefully considered in relationship to its particular location. What may be appropriate in one location may not work in another. Each proposed sign will be evaluated on its originality and compatibility with neighboring signs, and its overall image within the Shopping Center.

The Landlord reserves the right to disapprove any sign design that is not compatible with these criteria and the aesthetics of the Shopping Center.

This Criteria is intended to harmonize with the leasing documents. It is the responsibility of the Tenant to forward a copy of these Criteria to their architect, contractor and various consultants.

No deviation from the enclosed Criteria requirements will be accepted without prior written approval from Macerich.

Signage design and construction must be code compliant.



## > PRIMARY SIGNAGE

Your primary sign is an opportunity to express your Brand's identity and individuality at the entry portal of your store.

The following sign types are encouraged as design options for your primary signage:

- **REVERSE CHANNEL (HALO LETTERS)** minimum of 3" deep and projected from the background.
- **INTERNALLY ILLUMINATED** sign housings having unique shapes with letters routed out and formed letters protruding beyond the routed out letter.
- **EDGE-LIT, SANDBLASTED GLASS** with a continuous light source.
- **CAST METAL LETTERS** raised or flush with the fascia surface.
- **GOLD LEAF** on glass or stone.
- **SILK-SCREENED** glass or metal panels.
- **INDIRECT ILLUMINATION** on non-internally illuminated signs (artisan type panel signs).

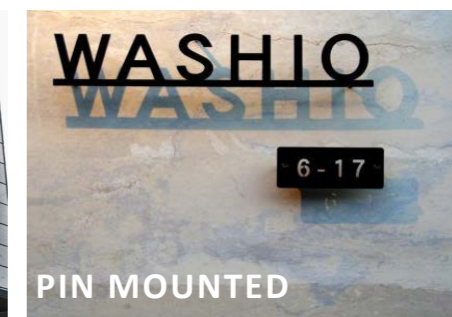
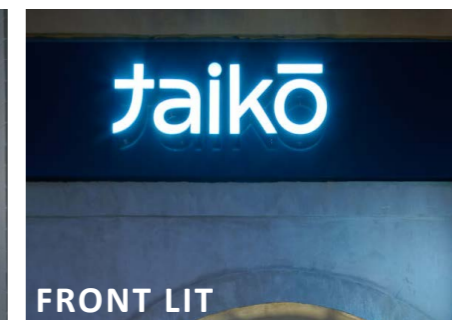
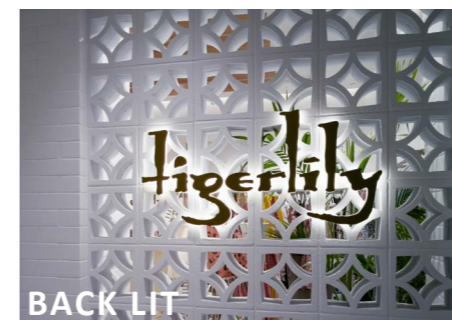

## > CONTENT / DESIGN ELEMENTS

### SIGN CONTENT

- Sign wording is limited to the Tenant's trade name and shall not include specification of merchandise sold or services rendered, regardless of the Tenant's legal name. Corporate crests, logos or insignia may be acceptable pending the Landlord's approval and provided they are part of the Tenant's name.

### SIGN DESIGN ELEMENTS

- All primary Storefront signs must be illuminated. External illumination designs are subject to Landlord approval.
- Imaginative signs utilizing a variety of materials are encouraged. Adaptation of current sign practices may be necessary in order to comply with these criteria.
- Backlit components must be contained wholly within the depth of the letter. Maximum brightness may not exceed one hundred (100) foot-candles.



## > PLACEMENT / CONSTRUCTION / DIMENSIONS

### SIGN PLACEMENT

- One sign is permitted per store frontage unless additional signage is approved by Tenant Coordinator. Tenants occupying corner spaces may utilize one sign per elevation with a maximum of two (2) signs, or one sign on a diagonal corner. For unusually long Tenant Storefronts, more than one sign may be allowed, with Landlord approval.
- Bottom of sign to be at 9'-0" A.F.F. minimum.

### SIGN CONSTRUCTION/INSTALLATION

- All Storefront signage and lighting, both interior and exterior, are required to be on a separate circuit and controlled by a time clock. Storefront signage and lighting are required to be on during operating hours and off during non-operating hours. This includes exterior building Storefront signage.
- Electrical raceways are not to be visible.
- High quality fabrications are required. Hums, flickers and light leaks are not permitted. Attachment devices, bolts, clips, threaded rods, fasteners, tubes, raceways, conduit, and other mechanisms are to be concealed. All labels must be away from public view. Signs must comply with all codes and regulations, must bear the UL label, and must have current sign permits.
- Tenant may use Landlord bulkhead for lateral bracing only.
- Threaded rods or anchor bolts shall be used to mount sign letters spaced out from background pane. Angle clips attached to letter sides will not be permitted. All bolts, fastenings, and clips shall be of hot-dipped galvanized iron, stainless steel, aluminum, brass or bronze, and no black iron materials of any type shall be permitted.
- Advertising placards, banners, pennants, names, insignia, trade-marks and other descriptive material may not be attached to the storefront or glazing.
- Visible weep holes are not permitted.
- Any existing holes from previous Tenant signage must be patched and painted.

### DIMENSION REQUIREMENTS

- Store sign shall not exceed 70% of the Storefront width, a distance which shall be determined by the lineal footage of the Tenants lease line.
- Logos cannot exceed 30" square depending upon the application.
- Uppercase letters shall not exceed 24" in height.
- Lowercase letters shall not exceed 20" in height



### LIGHTING REQUIREMENTS

- Metal letters, back lit (halo effect) with warm white light (3200K<sup>o</sup> - 3500K<sup>o</sup>). Letters must be a minimum of 6" in depth, and must be projected from the background with one inch spacers.
- Internally illuminated channel letters, with opaque sides and plastic faces, (3200K<sup>o</sup> - 3500K<sup>o</sup>) luminous tubing illumination within letters. Letters should not be more than 9" in depth. The Plexi-glass color will be determined on an individual mall basis. Trim caps are to match letter color.
- Letters are to be individually illuminated with white neon.

### DESIGN AND FABRICATION REQUIREMENTS

- While the letters are to be individually illuminated with white neon, the "Plexiglas" color is to be determined on an individual mall basis. Trim caps are to match letter color.
- No exposed raceways, crossovers, conduit conductors, transformers, etc. shall be permitted.
- All signage and sign components shall be UL listed.
- All exterior signage components (logos and all individual letters) shall stand off the face of the wall surface by a distance of 1/4 inch. This shall be accomplished by the use of nylon spacers placed between the face of the wall and the back of the logo or letter.
- All metal letters shall be fabricated using full-welded construction.

### EXTERIOR SPACE IDENTIFICATION

- If Tenant has a non-customer door for receiving merchandise, Tenant may place its name and address on said door in a location approved in writing by Landlord's Tenant Coordinator, using two inch (2") high block letters. Where more than one (1) Tenant uses the same door, each name and address may be applied. Landlord's Tenant Coordinator shall also specify the size, type and color of numbers.
- Tenant may install on its Mall Storefront, if required by the US Postal Service, only the numbers of Tenant's street address and only in such location as Landlord shall specify. Landlord's Tenant Coordinator shall also specify size, type and color of numbers.





## > SECONDARY SIGNAGE

In addition to the Primary Sign, all signage visible from the exterior of the store are considered Tenant Signs. These do not include messages used to advertise products, sales, or special events. Several various Secondary Signs are allowed at the Center and detailed in this section.

The following general Secondary Sign requirements must be met by all Sign varieties:

### GENERAL

- Signs must be kept within the the lease line.
- Signs must be in proportion to the overall storefront and composition.

### MESSAGING

- Trade name and/or logo only, are allowed.
- No taglines may be incorporated.
- Established logos will be allowed and will be counted in the overall area calculations.



## > WINDOW / THRESHOLD

Secondary signage types and their requirements include:

### STOREFRONT WINDOW SIGNS

If the Tenant wishes to provide additional Tenant identity, it is to be located at the pedestrian level on the inside face of the Storefront glass.

- Glazing signs are to be translucent (similar to frosted glass), reverse-reading and applied directly to the interior of the glass surface.
- Tenant graphics on Storefront glass shall be computer cut fat vinyl graphics (text/letter/logos)
- Maximum allowable area of signage is subject to Landlord's review and approval.
- Tenant graphics/logo will be limited to a maximum of three (3") inches in height.

### THRESHOLD SIGNS

In addition to Storefront signs, Tenants are encouraged to incorporate signs into their entry way flooring. Landlord will review threshold signs on an individual basis.

- Threshold signs are to be graphics comprised of logos, crests and accent.
- Finish is to be flush with adjacent materials and consistent with entry flooring quality.
- Recommended materials are wood, tile, stone, metal and terrazzo inlays.
- Threshold signs are not to extend beyond their lease line into the Center.



## > AWNINGS / BLADE SIGNS

### AWNINGS

Some Tenant Storefront designs include projected awnings. Landlord will review awnings and their signage on an individual basis.

- Glass or metal are the preferred materials of choice, although fabric awnings will be considered.
- Awning signage may be considered as the main Tenant's identification at the sole discretion of the Landlord in the interior of the Mall only.
- Signage may occur on the valence of the awning and may be painted or silk screened in a contrasting color.
- Logos shall be silk-screened and submitted with awning and sign drawings. Size of the logo shall be proportionate to the overall width of the awning and subject to Landlord's approval.
- The lowest point of the awning or shade shall be a minimum of eight feet (8'-0") above the finished floor. It is the designer's responsibility to ensure that awnings conform to all applicable codes.
- Materials such as Pana-flex, plastic or other vinyl materials shall not be permitted.
- Awnings shall be cleared and maintained in good condition at the sole expense of the Tenant
- Wording on awnings is limited to Tenant's DBA only.

### BLADE SIGNS

A blade sign is a double-sided sign mounted perpendicular to the building facade and suspended on a metal bracket, to be placed near the entrance(s) to a retail space.

Blade signs are subject to Landlord approval and may not be approved at all Store locations.

The following requirements must be followed for the design and installation of blade signage:

- The blade sign letters (if any) shall be a minimum of 4" high. Graphics must be three dimensional. Blade sign and bracket together may not extend beyond a box measuring 30" tall x 36" wide. The maximum thickness, including all sculptural elements is 6".
- Blade sign must be mounted directly to Tenant's Storefront, not Landlord finishes. Bottom of sign must be a minimum of 9'-0" AFF.



## > PROHIBITED SIGNS AND MATERIALS

### **PROHIBITED SIGNS AND MATERIALS**

The following sign types and materials are not permitted:

- Internally illuminated plexi-faced channel letters.
- Vacuum-formed or injection-molded plastic signs.
- Cabinet or standard “can type” signs with illuminated translucent backgrounds and silhouetted letters.
- Exposed skeleton neon applied directly to fascia element.
- Temporary or ‘sales’ signs attached to Storefront.
- Freestanding tripod signs.
- Flashing, scintillating, moving, sequencing, audible or odor producing signs.
- Paper, cardboard and Styrofoam signs.
- Credit card and advertising placards, decals, stickers or trademarks.
- Manufacturer labels.
- Carpet or rubber entry mat signs.
- Internally illuminated awnings.
- Signs employing un-edged or uncapped plastic logos or letters with no returns and exposed fastenings.
- No simulated materials (IE: wood grained plastic laminates, Zolatone etc.) or wall covering permitted.
- Signs painted on Storefront.
- No radioactive material shall be allowed to be used or installed as part of any Tenant construction scope of work. Furthermore, no radioactive signs such as Tritium exit signs shall be allowed in our Shopping Centers.

# TECHNICAL CRITERIA > CONTENTS

- ELECTRICAL**
  - POWER SOURCE / METER
  - REQUIREMENTS / SYSTEM REUSE
  - DATA & COMMUNICATIONS / LIGHTING
  
- LIFE SAFETY**
  - SPRINKLER / FIRE ALARM
  
- PLUMBING**
  - METER / REQUIREMENTS
  - GAS
  
- MECHANICAL**
  - GENERAL / LOAD CALCULATIONS / OVERVIEW
  - EXHAUST / ROOF / OUTDOOR AIR
  - BMS / SMOKE / TOILET EXHAUST / CONDENSER
  - RESTAURANT & ODOR REQUIREMENTS / TEST & BALANCE
  - CONSTRUCTION STANDARDS
  
- STRUCTURAL**
  - REQUIREMENTS / UNDERGROUND WORK / EGRESS

## SECTIONS OF INTEREST

- BUILDING DETAILS**  
Includes Property reference photos and specific Storefront design details.
- PROPERTY INFO**  
Includes information on the Property's building codes, area permitting, and required contractors.
- SUBMITTALS**  
Outlines requirements on how and what to compile for submittals to the Landlord for design reviews.
- ADDENDUM**  
Includes additional info on exterior signage requirements.

**The Inline Technical Criteria provides buildings details and design requirements for the Center's technical systems.**

It is the Tenant's responsibility to verify existing conditions and comply with all applicable codes and standards for technical systems.

Tenants are required to adhere to the full Criteria during their design and construction.

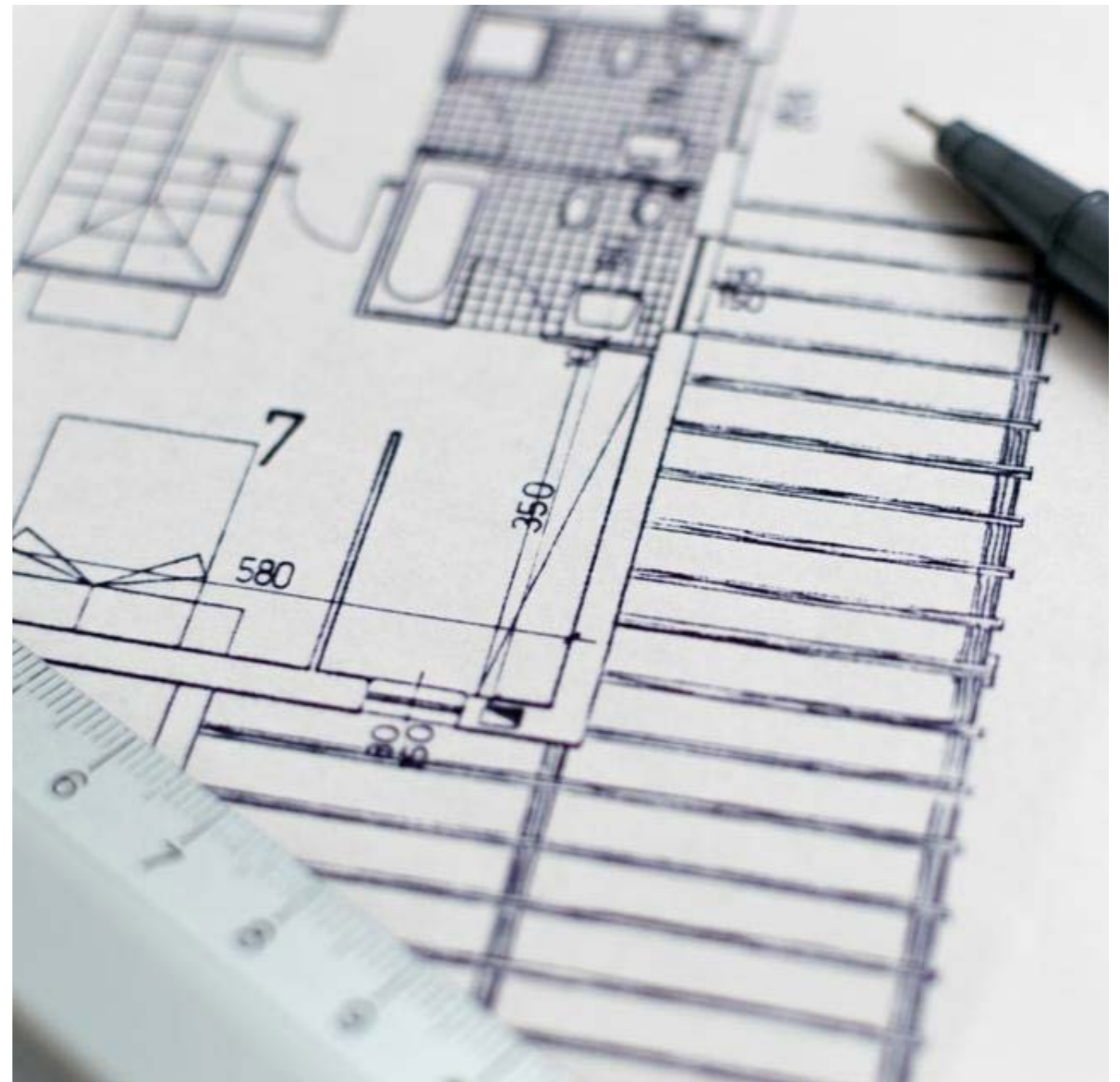

## > ELECTRICAL > POWER SOURCE / METER

### PROVIDED POWER SOURCE

All work required to connect Tenant to the main power source must be performed by Landlord approved electrician, at Tenant's expense. Exceptions to this requirement may be granted by the Tenant Coordinator.

Tenant is responsible for feeders to the Tenant space, installation of a dry type transformer, panels and complete distribution throughout the Tenant space. A General Electric demand check meter must be installed in the Mall electric room.

Landlord will make available the main power source for Tenant's connection. Power source will be 277/480v or 120/208v, 3 phase, 4 wire and will be available in the nearest Mall electric room. Tenants are responsible for installation of the fused buss duct disconnect switch and must pull the feeder wires to the Tenant's demised premises. Landlord will provide an empty 2" conduit with pull-wire from the mall electric room to the Tenant space. If a larger conduit is required, Tenant is responsible for installation of same from the power source to the demised premises.

#### I. TENANT REQUIREMENTS

Tenants are required to meet the following requirements related to connecting to their power source:

- **MAIN POWER SOURCE CONNECTION** must be performed by the Landlord's designated electrician, at the Tenant's expense.
- **FEEDERS** to the Tenant space are the Tenants responsibility, installation of a dry type transformer, panels and complete distribution throughout their space.
- **DEMAND CHECK METER** must be installed in the Mall electric room or in Tenant's space for those areas of the mall where applicable. (Check with the mall's Operations Manager or Tenant Coordinator prior to construction start).
- **UTILITY COMPANY ARRANGEMENT** is a Tenant responsibility to arrange for electrical service and meter at Tenant's expense.
- **LARGER CONDUIT**, if required, is a Tenant responsibility to install from the power source to the demised premises.

### METER DETAILS

Electrical use is sub-metered and charged by the Landlord. However, check with your Tenant Coordinator as some parts of the Center are not sub-metered. If a space is not sub-metered, it is the Tenant's responsibility to contact the Utility company for meter installation.

#### I. ELECTRIC METER REQUIREMENTS

- **REVENUE GRADE** meters are required.
- **DISPLAY** must be at least 6-digits.
- **METER MUST READ** demand (kW) and usage (kWh).
- **METER MUST CAPTURE** the electric usage of the entire Tenant space, including HVAC units. If this is not possible, then it must be noted.
- **METERS WITH CT** must note if a multiplier is required and what the multiplier is on the face of the meter.

#### II. EXISTING METERS

If there is an existing electric sub-meter in the Tenant's space:

- **RECOMMISSIONING** the meter is the Tenant's responsibility to ensure proper installation and functionality or;
- **NEW METER** may be installed by the Mall required vendor, and will be at the Tenant's sole cost.

### ELECTRICAL SUB-METERING ENERGY EFFICIENCY

Tenants 5000 gross square feet and above are required to provide and install Electrical Sub-Meters, per New York City Council File Number Int 1160-2016. Electrical Plans showing meter location and installation shall be submitted and approved prior to tenant build-out. Tenant is required to coordinate with local utility and Ownership for any shutdowns as a result of meter installation. Ownership reserves the right to back charge installation fees to Tenant found not to have required sub-meter.

# > REQUIREMENTS / REUSE

## SYSTEM REQUIREMENTS

- Drawings must include complete material specifications including manufacturer's name and product number and complete schedules of all equipment and fixtures.
- All material and equipment must be new and of a commercial grade and must bear Underwriter's labels where such labeling applies.
- At grade level electrical conduit may be installed at least 4" under the slab and must be in Schedule 40 PVC conduit. But never allowed to be installed in the slab or less than 4" below slab.
- Pull boxes or junction boxes must be a minimum of 12 gauge galvanized steel outlets. Boxes in walls must be galvanized pressed steel or case metal. Caulk around boxes to eliminate noise transmission.
- All main and branch feeders and circuitry wiring must be copper. All conductors to have 600 volt insulation type THW, THWN or THHN.
- Convenience receptacles must be specification grade, 120 volt, 20 amps and be grounding type per NEC.
- Manual or magnetic starters, switches, contactors, relays, time switches, safety devices, dimmers and other controls must be commercial type with heavy duty ratings and must be installed in strict conformance with the manufacturer's recommendation and applicable codes.
- Conduit and raceway hangers, clamps, light fixtures, junction boxes, supports, etc. must be fastened to joists and/or beams. Do not attach directly to the slab, roof deck, ductwork, piping or conduit above.
- Exposed low voltage wiring must be plenum grade.
- All wiring of any type must be installed in conduit or must be armored cable (BX). Armored cable will only be allowed for concealed branch circuit wiring within the demised premises. Exposed and/or open wiring of any kind will not be allowed. Flexible conduits must be used for connections to vibrating equipment.
- Tenant's equipment in the Mall electric room must be clearly identified with Tenant's name and space number.
- Provide access panels at all junction box and smoke detector locations above the ceiling.
- All outlet boxes, floor boxes, wire raceways, power/telephone poles, plug-in molding, wiring devices, hanger supports, and other items required for a complete distribution must be furnished and installed by Tenant. Floor boxes must be watertight.
- Furnish and install power to roof top units, water heater, store fixtures, signage, music systems and any other fixtures or equipment provided by Tenant. All cutting and patching must be provided by Tenant.
- All step-down transformers shall be floor mounted. Suspending and wall mounting of transformers is not allowed.

- All electrical wiring must be copper and must be installed in conduit in accordance with the National Electric Code, New York City Electrical Code and other applicable codes. Branch circuits concealed within walls or above finished ceilings may be MC (Metal Clad) Cable with an insulated ground conductor.
- The Tenant shall provide electrical connection(s) to the HVAC equipment serving the Tenant's space. This will include the rooftop unit(s) (RTU) and smoke exhaust fans (SEF).
- The Tenant shall acquire approval from the Landlord for any roof penetrations, which shall be by Landlord's approved contractors.
- The provided service size is based on the tenant's square footage and usage. This is illustrated in the table below:

Tenant Electrical Service Sizes (460Y/265 volt)								
Function	Service Capacity	Service Size Maximum Area of Coverage (SfFt)						Comments
		30 Amps	60 Amps	100 Amps	200 Amps	400 Amps	800 Amps	
Retail	20 Watts/SF	1,076	2,151	3,585	7,171	14,341	28,683 (0.9 Power Factor)	
Restaurant	30 Watts/SF	717	1,434	2,390	4,780	9,561	19,122 (0.9 Power Factor)	

- Should the Tenant require less capacity, the fuses in the Landlord's MDP can be replaced with small fuses with no disruption of service to other Tenants.
- Tenants that require more capacity than provided by the Landlord may incur a charge.
- Any requests for increases in service size shall be made in writing to the Landlord and supported by an electrical load breakdown including total connected and demand loads.
- The Tenant's Electrical Engineer shall submit final project drawings for review to the Landlord for approval.
- Below is a table showing a comparison between the common service sizes at 460 volts and the corresponding amperage at 208 volts. This is to help the Tenant understand the capacity of the higher voltage service that they are receiving at 460 volts compared to services at 208 volts that they may be more familiar with. The power (given in KVA) provided to a tenant is a function of voltage and current. As shown below, as the voltage is increased the current decreases, but the power delivered is the same. E.G.: 30 Amps at 460 volts results in 24 KVS. 24 KVA at 208 volts yields 67 Amps.

Service Voltage Comparison		
460 Volts	Power	208 Volts
30 Amps	24 KVA	67 Amps
60 Amps	48 KVA	133 Amps
100 Amps	80 KVA	222 Amps
200 Amps	159 KVA	441 Amps
400 Amps	319 KVA	885 Amps

# > DATA & COMMUNICATIONS / LIGHTING

## DATA AND COMMUNICATIONS – INSTALL AND PROVIDER REQUIREMENTS

Telecommunications service is provided and administered throughout the Center by Verizon and Time Warner.

- **ACCOUNT SETUP AND SERVICE INSTALLATION** is the Tenant responsibility to coordinate direct through the utility company. Other data providers are not permitted at this property as they do not have an access agreement in place.
- **TELEPHONE DEMARC WORK** must be performed by Landlord's approved telephone subcontractor.
- **TELEPHONE SERVICE** is the Tenant responsibility to contact the local Telephone Company and install within their premises. Service capacity per Tenant is based on six telephone lines and one additional line per each 1,000 square feet of Tenant space.
- Landlord will provide a 1" empty conduit to the Tenant's space from the nearest Telecom room with pull string.
- Tenant will be responsible for providing a plywood backboard and punch down blocks into their space. The Tenant will be responsible for all wiring, and wiring connections.

## MUSIC/SPEAKER SYSTEM

These systems will not be provided by the Landlord and will be the responsibility of the Tenant to provide, as the Tenant requires. Any sound systems installed by the Tenant in their space must be designed to minimize sound emission into adjacent spaces.

## CABLE TELEVISION SYSTEM

Provisions for Cable Television (CTV) service will be located in the buildings Telecom rooms. It will be the responsibility of the Tenant to coordinate with the CTV Company for service connections and cabling. The Tenant shall have all proposed cable routings through the building approved by the Landlord prior to starting work.

## SATELLITE TELEVISION CAPABILITIES

The Landlord is not providing this service for the Tenant. Tenant's requiring Satellite Television Service shall make a request to the Landlord for roof penetrations and conduit routings through the building. All proposed cable routings through the building, roof penetrations, and mounting details to the roof must be approved by the Landlord prior to starting work. Tenant's architect to submit mounting detail to Landlord for approval. Roof work must be performed by Landlord's approved roofing contractor at Tenant's expense. Approval is required prior to scheduling installation.

## SECURITY SYSTEMS

The Landlord is not providing a security system in the Tenant's space. It is recommended that the Tenant install a system of their choice to secure their assets.

## LIGHTING – SYSTEM REQUIREMENTS

- **LIGHTING IN TENANT SPACE** is the Tenant's responsibility. The Tenant will not install any lighting outside the Tenant's space with the exception of Mall required standard lighting at back doors. These fixtures shall be photo cell controlled.
- **LIGHTING SCHEDULE** is required for review in conjunction with a reflected ceiling plan.
- **TIME CLOCK** is required to control display window lighting and be on during the hours the Shopping Center is open.
- **DISPLAY WINDOW LIGHTING** at the ceiling must be glare-free and at approved levels at the storefront glass line and not hang down below the top of storefront glass.
- **RECESSED INCANDESCENT DOWN LIGHTS** are permitted.
- **DECORATIVE LIGHTING FIXTURES** for storefront illumination, such as luminous ceilings, chandeliers, pendant or wall units or clear type glitter strips are permitted if approved by Landlord. No strobe, spinner or chase type lighting shall be used.
- **CODE REQUIRED LIGHTING** such as exit, emergency and night lights must be provided throughout.
- **SALES AREA FLUORESCENT LIGHTING** must be recessed and must use metal parabolic louver type lenses with a minimum of 18 cell configuration for a standard 2' x 2' fixture. Bare lamp fluorescent or fluorescent fixtures with acrylic prismatic lenses may be used only in concealed areas or stock rooms.
- **TRACK LIGHTING** may be used if the track is painted to match the ceiling color.
- **LIGHTING CONTROL SYSTEM** is the Tenant responsibility, including connection to the Building Management system and connection to the Fire Alarm system.

## LIGHTING EFFICIENCY

Tenants are required to upgrade their lighting system to meet or exceed New York City Energy Conservation code in accordance with New York City Council Fire Number Int 1165-2016. Lighting designs shall be submitted and approved by Ownership and local authority prior to tenant build-out. Ownership reserve the right to back charge installation fees to Tenant found not to be in compliance with New York City Energy Conservation code.



## > LIFE SAFETY > SPRINKLER / FIRE ALARM

### **SPRINKLER SYSTEM REQUIREMENTS**

- All work must be carried out by the Landlord's required sprinkler contractor at the Tenant's sole cost and expense.
- All work on the sprinkler system must be carried out between the hours of 7:00 am and 3:00 pm, Monday through Friday, so that the fire system can be filled and tested by 3:30 pm. The Sprinkler shut down fees are \$400 if occurring between 7:00 am and 3:00 pm Monday to Friday and \$500 at all other times or part thereof plus associated costs for additional security, fire watching, etc. The Tenant's approved sprinkler contractor will drain and fill the system.
- The Tenant's Contractor shall notify the Landlord in writing at least 72 hours in advance of making any modifications to the sprinkler systems in order for Landlord to notify the fire department and alarm monitoring company. The Tenant's Contractor must notify the Landlord when the system is ready to go back online.
- The contractor shall contact Atlas Park maintenance supervisor at least 60 minutes prior to any drain down. Contractor shall remain for one hour after the system has been refilled to check for leaks or other problems.
- No system will be left to drain overnight. All systems have to be charged and operational when personnel leave at the end of the working day.
- All piping shall be installed as close to walls and as high to underside of roof/floor framing as possible. Minimum 12'-3" AFF to bottom of any utility piping.
- The Tenant shall contact FDNY for specific requirements relating to quantity, location and type of fire extinguishers.
- All sprinkler heads in public service or sales area must be concealed type.
- Automatic sprinkler system feeds have been supplied by the Landlord in accordance with, Subchapter 17, Article 4 of the New York City Building Code. Sprinkler design is based on ordinary hazard group 1.
- All materials and construction shall meet code requirements and be to the complete satisfaction of the local or State fire marshal at a minimum.
- All sprinkler system piping shall be steel pipe schedule 40 black.
- Standard sprinkler heads in areas without ceilings will be Quick Response Type, upright bronze heads.
- Standard sprinkler heads in areas with finished ceilings will be Quick Response Type, recessed heads.
- Tenants with single-story buildings and those that are located on the first-floor of buildings with direct access from the surrounding streets are exempt from fire standpipe requirements.
- In buildings greater than one-story, standpipes have been supplied in accordance with Subchapter 17, Article 3 of the New York City Building Code.

- Standpipe locations have been supplemented with remote hose cabinets as required to ensure that a 125-foot hose plus 20 feet of hose stream will access all portions of the floor plan.
- If a tenant installs partitions such that the hose coverage requirements can no longer be met, the tenant shall at their expense install an additional auxiliary hose station(s) and interconnect with the standpipe system.
- All materials and construction shall meet code requirements and be to the complete satisfaction of the local or State fire marshal at a minimum.

### **FIRE ALARM REQUIREMENTS**

- Tenant must provide a complete fire alarm detection system within the Tenant space as an extension of the Landlord's building-wide addressable fire alarm system.
- Tenant is required to use Landlord's designated contractor for installation of the necessary smoke detectors and connection to the main fire alarm system. System must comply with the requirements of the governing authority.
- All emergency lighting, exit signs, horns and strobes must be provided by Tenant as required by code.
- The building is protected by an addressable Interior Fire Alarm (IFA) system. Speakers, voice evacuation commands and firefighter phones are not required in the space.
- When required by the New York City Building Code, or other authorities having jurisdiction, Tenants shall furnish and install their own complete, addressable, fire alarm system that is compatible with the Landlord's networked system. Tenant is responsible for any devices and connection costs as may be required to interface with the Landlord's system. All work shall be performed at the Tenant's expense for any portion of the system, whether inside or outside the Tenant's premises. All interface connections shall be made by the Landlord's nominated fire alarm contractor at the sole cost and expense of the Tenant.
- Tenant's are required to add additional horn/strobe devices throughout their space as required by code. Each Tenant space will have a minimum of 1 existing horn/strobe.
- The Tenant's horn/strobe circuit is connected to the FACP (Fire Alarm Control Panel) via a BPS (Booster Power Supply). The Landlord is providing 1 BPS circuit per tenant.
- The Tenant will be responsible for coordinating with the Landlord for having the system tested when additional devices are added. The Tenant will make arrangements with the Landlord to have the Landlord's preferred contractor perform all final acceptance testing of the system.
- The Tenant shall coordinate with the Landlord for any required connections to the FACP. This includes restaurant tenants with exhaust hoods that would require a dry contact connection at the FACP.
- The Tenant will provide all wiring and connection(s) for the Tenant's RTU(s) and SEF(s) to the FACP.

# > PLUMBING > METER / SYSTEM REQUIREMENTS

## SYSTEM OVERVIEW

Tenant shell spaces are typically provided a capped domestic cold water line and sanitary line stubbed into the space. Lines are typically 1 1/2" for retail and 2" for restaurants. Cold water is provided at a pressure sufficient to enable use of flush valves at 12 PSI. Domestic hot water is not provided. Tenants shall supply electric water heater tanks if desired with water stored at temps not less than 140 degrees F and controlled to prevent scalding.

## WATER METER REQUIREMENTS

- **INSTALL** must be by a Landlord approved electrician. Water meter can be obtained from The Water Group. Contact info is located in the [PROPERTY INFO](#) section.
- **SIZE** must be a proper fit for the space. Generally this means the size of the meter should match the size of the water line, or 1/4" smaller.
- **VERIFICATION AND APPROVAL** of install must be obtained by the Operations Manager, or a member of the Operations staff at the property.
- **PROOF OF INSPECTION** sent to the Tenant Coordinator including:
  - Date of installation or recommissioning
  - Meter make and model
  - Picture of the meter at time of installation or recommissioning
  - Units that the meter reads in
  - Multiplier, if applicable
  - Confirmation that the meter covers whole tenant space

## SYSTEM REQUIREMENTS

### GENERAL REQUIREMENTS

- Tenant shall provide a main water shut off valve located at eye level in a wall behind a labelled access door. Locate in or near employee restroom as designated by Landlord.
- All domestic supply lines shall be copper. Sanitary and vent lines traversing the ceiling area to be cast iron or copper (no PVC). Tenant will utilize electric water heaters for domestic hot water.
- Water hammer arrestors shall be installed per PDI requirements.
- A water meter to measure the amount of water used must be installed by the Tenant below the lavatory. If applicable, second level restrooms must install a floor drain. Mop sinks and water fountains must be installed per local code requirements.
- Tenant must install clean outs as required by code and Landlord's requirements and these shall terminate flush with the finish floor or wall. No clean outs are permitted above the ceiling.

- Garbage disposals are not allowed.
- Tenants on the upper level must coordinate with lower level Tenants and the Landlord for floor penetrations and any plumbing under the upper level floor/deck. Tenant will be responsible for all cost associated with this work.
- Tenants must submit calculations to the Landlord which show the size selection or basis of capacity of all equipment and piping.
- Domestic water piping material shall be Type "L" copper with sweat type fittings.
- A reduced pressure backflow preventer shall be installed by the tenant on all tenant water connection to systems or equipment that are deemed hazardous. This includes, but is not limited to, photo processing equipment, carbonation systems, etc.

### VENTILATION

- Tenants will provide vertical exhaust ducts at a location designated by Landlord. All hood exhaust must be connected to vertical duct in accordance with code. Tenants are required to provide for the upkeep and maintenance for such vertical exhaust duct and related devices and materials.
- All sanitary sewer and plumbing vent piping shall comply with all local codes.

### MINIMUM CONSTRUCTION STANDARDS

- Air conditioning condensate drain piping shall be copper "L" seamless hard drawn. All condensate drain lines shall discharge to a receptor in compliance with code.
- Domestic water piping materials shall be Type "L" copper with sweat type fittings. Insulate all domestic water piping.
- Waste and vent piping materials shall be Type "L" copper with sweat type fittings. Insulate all domestic water piping.
- Gas piping shall be schedule 40 black steel pipes with malleable fittings. All piping in plenum spaces shall be welded connections.
- No PVC or ABS piping shall be used in any above grade plumbing installations.

# > SYSTEM REQUIREMENTS

## WATER EFFICIENCY

- Tenant is required to install waterless urinals in tenant restrooms when urinals are used.
- Low-Flow water closets using 1.6 GPF or less gallons per flush must be used.
- Operation sensors and low-flow heads using 0.5 GPM or less in lavatories.

## RESTROOMS

- Every Tenant must install a handicapped restroom facility with a minimum of one water closet and one lavatory and in accordance with local code officials. An exception to this requirement is only permitted for Food Court Tenants who are within proximity to the public restrooms upon approval of the Landlord and local code official.
- Low water consumption fixtures and controls shall be required for water conservation.
- The Tenant shall install floor drains with trap primers in each Tenant toilet room.

## WATERPROOFING

- Waterproofing must be installed in all “wet areas” such as kitchens, restrooms, mop sinks, drinking fountains, etc. The waterproof membrane must extend 4” vertically on all demising walls. This membrane will be water tested by the GC and inspected and signed off by Mall Personnel. If the membrane fails the water test, it must be replaced.

## FOOD SERVICE

- Each Restaurant tenant shall be responsible for the coordination, supply, and installation of a water meter at the point of connection to the Landlord provided service. Water meters with remote reading capabilities shall be installed in the tenant space. The Tenant is responsible for all work associated with the meter and remote reading hardware installation.
  - Restaurant Tenants: 2” size, Model #572IIS, with ER-1 Encoder.
  - Output conductor on ER-1 Encoder shall connect to Landlord’s Building Management System (BMS). Output conductors shall be installed by the Landlord.
- Food service, hair salons or other Tenants with equipment or operations that have the possibility of backflow will be required to install an approved backflow preventer. These must be certified and acceptable to the water district and checked yearly or as required by the local authority having jurisdiction.

## SALONS

- Any plumbing fixtures that receive hair, as in pet shops and hair salons, etc. are required to install lint and/or hair traps beneath each trapped fixture.
- Hair salons and pet shops shall provide hair and solids interceptors on all sinks and basins which may receive human or animal hair. After installation, these hair interceptors shall be properly maintained to keep the sanitary system free from any adverse conditions.

## SANITARY

- Sanitary and vent piping material shall be service weight cast iron with mechanical fittings.
- A sanitary riser or main is available within approximately 75 feet of the tenant space.
- A vent riser will be made available at the same location or within each tenant space.
- Each tenant will have the ability to connect to the vent riser/main within the ceiling cavity of the floor they occupy and to connect to the sanitary riser/main within the ceiling cavity of the floor below. All lateral sanitary and vent connections from tenant spaces to risers/mains to be by tenant.
- Tenant shall trench to sanitary main below slab or pump discharge to ceiling as appropriate. Any required sewage ejector and pit shall be provided by the tenant and shall discharge into the sanitary main located at the basement ceiling level.
- Where a building has no basement, a sanitary main below the first-floor slab shall be provided by the Landlord. All lateral sanitary and vent connections from tenant spaces to risers/mains to be by tenant.

## GREASE WASTE

- Except with Landlord’s prior written permission for non-compliance, all pot sinks, scullery sinks, pre-wash sinks, and other kitchen units must be connected to a grease trap. Dishwashers may not be connected to grease trap.
- If outside Tenants lease line, location of grease interceptor must be designed and approved by Landlord prior to installation.
- Tenants that prepare or serve food shall discharge waste from grease producing plumbing fixtures through tenant provided grease interceptor prior to connection to the base building grease waste system.
- In certain buildings, an independent grease waste system shall be provided by the Landlord. This system shall be routed to an external grease interceptor, the discharge of which shall connect to the sanitary sewer.
- A grease waste riser or main will be made available within 75 feet of each tenant space. Tenant is still required to provide a local grease interceptor.
- All grease interceptors shall be completely contained within demised premises, and shall be above floor type complete with flow control fitting and sized as using manufacturers procedure for sizing grease interceptors. Grease interceptors must be approved by the Landlord prior to installation.
- At the Tenant’s expense, designated Tenants must employ an independent service contractor to clean and maintain the grease interceptor within their premises. Tenant must provide Landlord with the name of the contractor and their plumbing/grease disposal license number.

## > GAS

### GAS SERVICE

All tenants shall arrange for their own gas service account from the local gas utility.

Gas may be available at the Center. Tenant, at its sole cost and expense and in compliance with local code must procure gas service to and within the demised premises and will make all necessary arrangements with the local Gas Company for such service.

- Tenant is responsible for installation of a gas meter at the gas meter header.
- Pressure regulators and piping required for connection to Tenant's equipment is the responsibility of the Tenant. Coordinate with Landlord for regulator vent routing.
- Gas piping on the roof must be placed on pillow blocks or similar arrangement.
- Only Tenants with rooftop HVAC units, and those specifically designated as Restaurants shall have the benefit of a natural gas service.
- Each restaurant Tenant will be provided with (2) gas connections, a connection for equipment (cooking) within their space and a connection on the roof for a makeup air rooftop unit (heating).
- Gas piping from the meters at the manifold, to the restaurant tenant space will be schedule 40 black steel and be able to deliver an operating pressure of 6 to 11 inches W.C. A manual shut-off valve will be provided, and the piping will be capped at the ceiling of each leased space.
- Size of gas piping shall be determined based on the following criteria:
  - Rooftop units: capacity required to offset building envelope losses and head ventilation air.
  - Kitchen equipment: 150 Btuh/sq. f. for restaurant tenants.
  - Makeup air units: 100 Btuh/sq. f. for restaurant tenants.
- Tenants who require a gas service larger than the service being provided, will be responsible for the complete installation of the new gas service.
- All Tenant gas piping must follow the route designated by the Landlord from the point of the gas manifold to the leased premises.
- All gas pipe joints outside the leased premises greater than 2" shall be welded.
- All-natural gas piping shall be installed as per applicable Local, State and Mechanical Codes.

# > MECHANICAL > GENERAL / LOAD CALCS / OVERVIEW

Depending on the Tenant location, Landlord provided HVAC systems can differ. The various systems and their design requirements are detailed in this section.

## GENERAL DESIGN REQUIREMENTS

- Tenant will provide the Landlord with engineering calculations which assure the adequacy and Code compliance of the HVAC system the Tenant is installing.
- Tenant will provide Landlord with shop drawings, installation guidelines and product samples (where requested) detailing all equipment to be installed. Landlord will have the final right of approval for all materials and equipment.
- The Tenant is to provide design drawings stamped by a Mechanical engineer licensed in the State of New York.
- All installations shall comply with governing codes and shall be approved by the Fire Marshal.
- Interior Design Conditions for All Tenants: 72°F heating; 78°F, 50% Relative Humidity (RH) cooling.
- Outdoor Design Conditions: As per 1997 ASHRAE 2-1/2% design (where outside air is not pre-conditioned).
- Tenants requiring additional services beyond what is provided (i.e. increased ventilation CFM, increased cooling capacity, etc.) will notify the Landlord in writing not less than 30 days from Lease signature date. This will allow time for design feasibility, drawing review, and Lease amendment.
- Theater: No HVAC provisions will be made for the theater area; the theater tenant is responsible for all associated HVAC.
- The Tenants connecting to Landlord's smoke purge system must provide a smoke-purge damper to Landlord's specification.
- All air handling units over 2,000cfm and any air handling units connected to Landlord's smoke purge system (regardless of size) must include a switch to enable shut down during alarm.
- All air and hydronic balancing must be performed and (2) copies of the report provided to the Landlord.
- Drainage pans must be provided at all condenser pumps.

## LOAD CALCULATIONS

- **HEATING LOAD CALCULATION** must maintain the minimum space temperatures in sales and public spaces of 68 degrees F and 50 degrees F in non-public spaces.
- **COOLING LOAD CALCULATION** must maintain the minimum space temperature of 73 degrees F and a maximum of relative humidity of 55 degrees F and shall take into account all interior heat producing items such as people, equipment, roof and exterior walls.

## HVAC SYSTEM OVERVIEW

Depending on the tenant location and subject to the Work Letter attached to the Lease, the Landlord provided air-conditioning units shall be one of the following:

- Type 1: Packaged rooftop units with gas heat.
- Type 2: Air-cooled split system units with electric heat (heating element by Tenant).
- Type 3: Water-cooled self-contained units with electric heat (heating element by Tenant).
- Type 4: Air-cooled self-contained units with electric heat (heating element by Tenant).

Atlas Park HVAC Systems Overview				
Building	Level	HVAC System	Outdoor Air	Toilet Exhaust
3	1	Split-System Air-Cooled (Type 2)	Direct	Central
	2S	Rooftop unit (Type 1)	Direct	Central
	2N	Split-System Air-Cooled (Type 2)	Direct	Central
	3N	Rooftop unit (Type 1)	Direct	Central
4	Bsmt	Split-System Air-Cooled (Type 2)	Central (Heated)	Central
	1	Split-System Air-Cooled (Type 2)	Direct	Central
	2	Rooftop unit (Type 1)	Direct	Roof
6	Bsmt	Water-cooled self contained (Type 3)	Central (Heated)	Central
	1	Water-cooled self contained (Type 3)	Central (Heated)	Central
	2	Water-cooled self contained (Type 3)	Central (Heated)	Central
	3	Rooftop unit (Type 1)	Direct	Roof
7	1	Rooftop unit (Type 1)	Direct	Roof
8	Bsmt	Split-System Air-Cooled (Type 2)	Central (Heated)	Central
	1	Water-cooled self contained (Type 3)	Direct	Central
	2	Rooftop unit (Type 1)	Direct	Central
	3	Rooftop unit (Type 1)	Direct	Roof

### NOTES:

"Direct" Outdoor air may come from roof intake or wall louver as appropriate. All "Central" systems shall be installed by Landlord with Tenant taps located at demising walls or risers. All rooftop toilet exhaust and structural framing is by Tenant.

# > MECHANICAL > OVERVIEW

## HVAC SYSTEM TYPE 1

- A constant volume, gas-fired rooftop unit(s) shall be provided by the Landlord with supply and return air ducts stubbed into the tenant space at one location.
- The unit shall be sized to provide all ventilation, cooling, and heating requirements for the Tenant space.
- Rooftop units larger than 5-tones shall be provided with an economizer. Relief air shall be discharged through power exhaust or barometric relief at the Owner's discretion.
- Distribution ductwork shall be by the Tenant.
- Unit shall be provided with a packaged controls system and a programmable electronic thermostat. Tenant is responsible for installation of control wiring, programming, and startup.

## HVAC SYSTEM TYPE 2

- A split-system DX air-handling unit(s) may be provided for a Tenant space depending on exhibit B of Lease ("Work Letter"); the Landlord shall install all associated refrigerant piping and the outdoor condensing unit.
- Air-handling unit installation shall be by the Tenant. The unit shall contain an electric heating coil. Refrigerant system change shall be by the Tenant.
- The unit connection to the ventilation air ductwork and all distribution ductwork shall be by the Tenant.
- Unit shall be provided with a packaged controls system and a programmable electronic thermostat. Tenant is responsible for installation of control wiring, programming, and startup.

## HVAC SYSTEM TYPE 3

- Condenser water taps shall be provided for each Tenant space; the Landlord may provide the appropriate water-cooled air-conditioning unit(s) depending on exhibit B of Lease ("Work Letter").
- Unit installation must be by the Tenant. The unit shall contain an electric heating coil.
- The unit connection to the ventilation air ductwork and all distribution ductwork shall be by the tenant.
- Unit shall be provided with 2-way control valves for condenser water control; valves must be regulating valve to modulate the flow of condenser water in response to demand. Such valves shall meet Landlord requirements.
- Unit shall be provided with a packaged controls system and a programmable electronic thermostat. Tenant is responsible for installation of control wiring, programming, and startup.

## HVAC SYSTEM TYPE 4

- An air-cooled air-conditioning unit(s) may be provided for a Tenant space depending on exhibit B of Lease ("Work Letter").
- Unit installation must be by the Tenant. The unit shall contain an electric heating coil.
- The unit connection to the louvers and all distribution ductwork shall be by the Tenant.
- Unit shall be provided with a packaged controls system and a programmable electronic thermostat. Tenant is responsible for installation of control wiring, programming, and startup.

## HVAC SYSTEM COOLING CAPACITY

- The Landlord provided HVAC units shall have sufficient capacity to serve the Tenant space based on the following parameters:
  - Building envelope load
  - Occupant load (with occupant activity per ASHRAE for retail):
    - Retail Tenants (first floor): 1 person/25 sq. f.
    - Retail Tenants (above first floor): 1 person/50 sq. f.
    - Restaurant Tenants: 1 person/19 sq. f.
  - Ventilation load as defined by the NYC Building Code.
  - Lighting/equipment load:
    - Restaurant and Retail Tenants 6 w/sq. f.
    - Office tenants 4 w/sq. f.

## HVAC SYSTEM HEATING CAPACITY

- The Landlord furnished air-conditioning units shall be provided with sufficient heating capacity to provide a unit leaving air temperature of at least 75°F based on:
  - Ventilation load as defined by the NYC Building Code.
  - Outdoor air conditions of 10°F or 55°F where a tempered outdoor air supply is provided by the Landlord.
- Except for rooftop units (which shall be gas-fired), all Tenant spaces shall be heated via electric heat.
- Each Tenant shall be responsible to provide supplemental electric heaters and/or heating coils to offset perimeter heat losses and to maintain the design conditions stated previously.

# > MECHANICAL > EXHAUST / ROOF / OUTDOOR AIR

## **EXHAUST REQUIREMENTS**

- Tenants whose operation produces objectionable odors such as restaurants, pet shops, hair salons, nail salons and the like must maintain 10% negative air pressure with respect to the Mall by providing make-up air equal to 90% exhaust air volume. Tenant may be required to provide, at Landlord's discretion, a separate make-up outside air supply system to balance Tenant's exhaust system. Spaces that require exhaust must be designed to provide negative air pressure relative to adjoining conditioned spaces to prevent odor transfer.
- Roof mounted exhaust fans must be ducted to ceiling grilles located approximately in the center and rear of the demised premises and specifically near the area where the odors are generated. The system shall be designed to cause the exhaust air to gravitate from the Mall common area to the odor producing area and then exhausted out.
- Air filtration systems and bathroom exhaust fans are not acceptable solutions.
- The exhaust fan must be interlocked with the light switches for the store customer service area.
- The combined HVAC and exhaust system must be in operation during all hours that the Tenant is open for business.

## **ROOF PENETRATIONS**

- If use of roof top units, roof-type supplemental supply, condensing units or exhaust air units by the Tenant is permitted by the Landlord, units must be located on that part of the roof of the building directly above the demised premises as designated by Landlord. Tenant must provide and install all necessary piping and other necessary appurtenances for the operation of the roof top equipment. To the extent any of Tenant's equipment is to be located on the roof, the Tenant agrees to erect roof units in accordance with the requirements of the Landlord and the Tenant further agrees to repair any and all damage to the roof and structure caused by hoisting installation and the maintenance and/or servicing of such equipment, all of which must be at the sole cost and expense of the Tenant.
- The Tenant must furnish and install all curbs, supports, lintels, pipes, ducts, vent caps, air inlets, exhaust hoods, louvers, flashings, counterflashing, etc. as required for any equipment requiring openings through the roof and/or exterior walls. The use of curb adapters is not allowed.
- The Landlord has the right to inspect the quality of the work and approve locations and, if found unsatisfactory, reject same.
- All cutting, patching, and restoring of roofing is to be done by the Landlord's roofing contractor at the Tenant's expense. All repairs, maintenance, and damage to the roof and/or building due to Tenant's installation must be at the Tenant's cost and expense.

## **ROOFTOP EQUIPMENT INSTALLED BY TENANTS**

- A rooftop curb will be supplied at Tenant's expense to a location specified by the Landlord. Should the Tenant wish to create a new curb other than the one provided, Structural drawings must be submitted to the Landlord for review and approval.
- The responsibility of installation of the rooftop equipment is to be taken on by the Tenant, who should plan accordingly by anticipating a crane hoist.
- Tenant is responsible for properly labeling all equipment on roof and for obtaining proper Equipment Use Permits for all rooftop equipment.

## **OUTDOOR (VENTILATION) AIR**

- Ventilation air quantities shall be provided to Tenant spaces as defined by the NYC Building Code. Depending on the tenant location, ventilation air shall be introduced to the tenant equipment either directly, or through a centralized outdoor air system.
- Where a centralized outdoor air system is installed, ventilation air will be ducted to each tenant area and an outdoor air system point of connection shall be provided at the demising wall. The ventilation air shall be heated to 55°F Summer, 55°F Winter and filtered, but not cooled.
- Where a direct ventilation system is in place, outdoor air shall be introduced either through tenant rooftop units or through louvers local to the tenant space.
- Tenant HVAC documentation must show a table detailing compliance with the Building Code Index for Ventilation.
- Unless tenant is served by a rooftop unit, tenant shall provide ductwork from their point of connection and directly connect to their air handler.

# > MECHANICAL > BMS / SMOKE / TOILET EXHAUST / CONDENSER

## **BUILDING MANAGEMENT SYSTEM**

- If applicable, Tenant must connect to the Mall's existing Energy Management System. In the process of Tenant renovation, the system must be upgraded to meet current criteria at Tenant's expense. Tenant must contact Landlord's designated contractor for the purchase and installation of the necessary controls and connection to the main control panel.
- Duct mounted smoke detectors are required and must be connected to the main fire alarm panel, if applicable. Each duct smoke detector must have a remote key operated reset/test device mounted within the Tenant space and an addressable relay module. Use Landlord's designated contractor for connection to the main fire alarm loop.

## **SMOKE PURGE SYSTEM**

- With exception of the theater area, a complete smoke purge exhaust system shall be provided by the Landlord per Subchapter 13, Article 1 of the New York City Building Code.
- The purposed of the smoke purge system is to exhaust smoke after a fire event has occurred. The smoke purge system shall be capable of exhausting 6 air changes per hour of the single largest floor (or 1 CFM per square foot - whichever is greater).
- Where smoke purge ductwork shafts shall serve multiple floors, combination fire/smoke dampers will be provided at each level to isolate the floor being evacuated.
- Within certain buildings of the Atlas park campus, the outside air ductwork will also serve as the smoke purge ductwork. All remaining areas will utilize separate outside air and smoke purge systems.
- Tenants shall not obstruct duct or alter smoke purge system components.
- All Tenants connecting to Landlord's smoke purge system must provide a smoke-purge damper to Landlord's specification (applicable to Buildings #3, 4, 6, and #8).
- All air handling units over 2,000cfm and any air handling units connected to Landlord's smoke purge system (regardless of size) must include a switch to enable shut down during alarm.

## **TOILET EXHAUST**

- Depending on Tenant location, Tenant shall be provided with access to the roof for a Tenant installed toilet exhaust fan, or access to a central exhaust riser.
- Where applicable, roof fan installation shall be by the Tenant. The Tenant may either utilize a Landlord provided roof curb, or where approved by the Landlord, provide a roof curb and all associated structural framing at their expense.
- In some locations, a central toilet exhaust system including exhaust fan(s) and duct-work riser(s) shall be provided by the Landlord, according to the following specifications:
  - The capacity of the toilet exhaust system shall be such that selected Tenants can connect to the central system.
  - The toilet exhaust allowance for each tenant is 2 CFM for every 5% of Tenant floor space (equivalent to 0.1 CFM/sq. f.). Actual exhaust CFM shall be determined by the Tenant based on the applicable code.
  - Tenants will be responsible for the ductwork installation from their space to the central exhaust riser. Location of ductwork shall be approved by the Landlord. Where ductwork passes through adjacent Tenant spaces, installation shall be coordinated with that tenant's requirements.
  - After connection is made, the central exhaust system shall be rebalanced at the Tenant's expense.

## **CONDENSER WATER SYSTEM**

- Where a Tenant is served by HVAC system Type 3, the Landlord shall provide valved and capped condenser water connections at the Tenant demising wall.
- Landlord shall deliver condenser water based on 3 GPM per ton. Tenant requirements beyond this rate shall be reviewed by Landlord at Tenant's expense.
- Where the existing condenser water system piping is being extended, the new piping shall be isolated from the existing system and shall be thoroughly flushed and cleaned and pressure tested before the existing condenser water is circulated through it. All HVAC system flushes must be performed by base building contractor at Tenant's cost.
- Tenant must provide and install a regulating valve to modulate the flow of condenser water in response to demand.
- Tenants must install meters on condenser water provided by Landlord.



# > MECHANICAL > RESTAURANT & ODOR REQUIREMENTS / TEST & BALANCE

## SPECIAL REQUIREMENTS FOR RESTAURANT TENANTS

### LANDLORD PROVISIONS

- Large restaurant tenants (greater than 1,000 sq. f.) shall be provided with provisions for kitchen exhaust, dishwasher exhaust and makeup air.
- Small restaurant tenants (less than 1,000 sq. f.) shall be provided with provisions for dishwasher exhaust only.

### KITCHEN EXHAUST

- Spatial provisions for kitchen hood exhaust duct risers shall be made, but no ductwork or exhaust fans shall be provided by the Landlord.
- Kitchen exhaust fans shall be located on the roof, the exact location shall be coordinated with the Landlord prior to installation.
- Tenant shall install at its sole cost and expense around all roof exhaust fans the UL Listed G2 Guard Rooftop Defense System by Facilitec (contact Facilitec at 800-282-8273; address: 3851 Clearview Court, Gurnee, IL 60631), or a substitute approved by Landlord. Tenant shall be responsible for obtaining a maintenance agreement for the upkeep of the G2 Grease Guard Rooftop Defense System (or the approved substitution), and a copy of the maintenance agreement must be submitted to the management office annually.

### KITCHEN MAKEUP AIR

- Spatial provisions for makeup air ducts shall be made, but no ductwork or exhaust fans shall be provided by the Landlord.
- Makeup air equipment shall be gas-fired roof-mounted and shall be provided by the restaurant tenant.

### DISHWASHER EXHAUST

- Spatial provisions for dishwasher exhaust duct risers shall be made, but no ductwork or exhaust fans shall be provided by the Landlord.

### OTHER

- All exhaust hoods shall be commercial grade. Hoods for grease-producing equipment shall be provided with grease filters/baffles and fire extinguishing systems.
- All exhaust ductwork must be installed in conformance with NFPA Bulletin 96, and the NYC Building Code. Location of exhaust ductwork penetrations must be approved by the Landlord prior to installation.
- A grease containment system is required for food service installations. The Tenant will provide the Landlord with a copy of the maintenance agreement for the grease containment system.

## SPECIAL REQUIREMENTS FOR ODOR PRODUCING TENANTS

The following special requirements apply to odor producing Tenants (including but not limited to hairstyle shops, pet shops, restaurants, fast food use shops or any other premise at the Landlord's discretion):

- Tenant is required to furnish and install the necessary equipment to remove or neutralize any odors. This work will be approved in writing by the Landlord and at the sole expense of the Tenant.
- The Tenant shall provide additional makeup air, as required to balance supplemental exhaust systems. This may come in the form of increased air supply from the base building system (where approved by the Landlord), or from an additional makeup air unit installed by the tenant. All costs incurred by the additional makeup air will be the responsibility of the Tenant.
- Tenants shall operate HVAC system between 5% and 10% negative pressure (when referenced to adjacent areas) and shall provide air balance report prior to store opening, and on an annual basis as required by the Landlord.

## TESTING AND BALANCING

- Tenant must provide for balancing of all hydronic and air systems. Balancing will be performed at the sole cost and expense of the Tenant. The hydronic and air balance report is to be provided to the Landlord prior to the tenant opening. The Tenant's mechanical contractor shall cooperate with the selected balance agency in the following manner:
  - Provide sufficient time before final completion date so that testing and balancing can be accomplished.
  - Provide immediate labor and tools to make corrections required without undue delay. Install balancing dampers as required by test and balance energy.
  - Mechanical contractor and balancing agency shall not alter or disable the smoke control dampers, or any other equipment associated with the smoke control or evacuation systems.
  - The contractor shall put all heating, ventilating and air conditioning systems and equipment into full operation and shall continue the operation during each working day of testing and balancing.
- Testing and balancing agency shall be kept informed on any major changes made to system during construction and shall be provided with a complete set of 'as-built' drawings.
- The system is to be balanced by the Tenant upon completion. A copy of this report must be sent to the Landlord for their records.

## > MECHANICAL > CONSTRUCTION STANDARDS

### MINIMUM CONSTRUCTION STANDARDS

- All Tenant HVAC systems shall utilize a ducted supply and plenum return. Ducted returns (above an acoustic or hard) ceiling will not be allowed. This requirements for plenum returns is due to the smoke purge system employed by the Landlord.
- Relief air (excess air), may be relieved directly into (or out of) the Tenant Premises if the Tenant Premises are not odor producing. The Tenant will provide mechanical exhaust as required by code.
- Where base building systems are being extended within tenant space (i.e. outdoor air ductwork, condenser water piping), provide mechanical identification for all piping, equipment, and specialties to match base building installation.
- All ductwork shall be galvanized sheet metal unless otherwise noted. All ductwork shall be installed in accordance with the latest publication of the ASHRAE guide and SMACNA.
- All kitchen exhaust ductwork must be installed in conformance with NFPA Bulletin 96, and the NYC Building Code.
- Provide vibration isolation on all duct connections to fans and other equipment with rotary parts.
- Duct mounted smoke detectors shall be provided in all air handling units. Tenant is responsible for connection to Base Building Fire Alarm System and shall hire the Landlord required Contractor to complete all work necessary.
- Local control of all Tenant air handling systems shall be by electronic, programmable thermostat with setback capability.
- Landlord required Fire Alarm contractor is responsible for tying the Fire Alarm for the system and dampers back to the designated Fire Alarm Panel. Consult with Landlord's required fire alarm contractor for details.
- Air conditioning condensate drain piping shall be copper type "1" seamless hard drawn, with wrought copper fittings.
- Refrigerant piping shall be copper: up to 5/8" O.D., type 1 soft tempered with compression fittings. 7/8" O.D. and over, type 1 hard tempered with high temperature brazed joints.
- Fire Dampers and Combination Fire/Smoke Dampers.
  - All ductwork shall be installed with fire-dampers or combination fire/smoke dampers between floors and through rated walls as required.
  - The separation between tenant's need be a rated assembly of not more than 1 hour. As per code, in a fully sprinklered building, any duct penetrations through this fire separation assembly will not be required to have a fire damper or combination fire/smoke damper. All dampers shall meet BSA #176-82-SM.
- Duct Shafts
  - The design and installation of all HVAC equipment, including ducts, shafts and their required penetration of rated partitions, ceilings, and floors, shall conform to the requirements of the mechanical criteria and applicable building code. HVAC ducts that penetrate through any floor level must be enclosed in a 2-hour rated shaft. The tenant being served by the ductwork shall install shafts.
- Flexible duct shall only be used as a branch take-off from main trunk duct to a single diffuser. Maximum length of run shall be 6 feet.
- Provide capped manual air vents at all hydronic system high points, and before all vertical drops in direction of flow, provide capped hose drains at all system low points, to enable the complete down-drain of the system.

# > STRUCTURAL > REQUIREMENTS / UNDERGROUND WORK / EXITING

## GENERAL REQUIREMENTS

- The Tenant's storefront must be structurally self-supported. Tenant may not support the storefront from the bulkhead or fascia. Structural lateral bracing support for Tenant storefronts must be from the roof joists.
- Fixtures and equipment may not be attached to or supported from the roof deck.
- Structural drawings are required for all items weighing 300 lbs. or more.
- Joist reinforcing is required for roof top equipment as well as steel support for all roof openings.
- Upper level Tenant's must review base building structural drawings prior to installing a security safe, ovens or any equipment weighing 300 lbs. or more.

## STRUCTURAL CRITERIA

- Maximum load on all levels is 75 lbs. reducible load per square foot. For loads exceeding 75 lbs. per square foot (i.e. safes, restaurant equipment, etc.) the Tenant will provide engineered drawings depicting the required additional structural support framing to be reviewed and approved by the Landlord's structural engineer. Any structural work shall be installed by Tenant at Tenant's expense.
- Roof Deck: 1 1/2" x 22 gauge galvanized "B" deck
- Floor Deck: 3" hard rock concrete on 3" x 20-gauge composite deck
- Landlord's architect shall design the building shell in which the Tenant Premises are located. Said building shall be constructed and sprinklered in accordance with the applicable building code. Exterior walls shall be masonry or such other materials, as Landlord's architect shall select.
- Construction of the building in which the Premises are located shall be Type VN typically, with theatre being Type II 1-hour. If restaurants are over the occupancy of 300 people, they fall into the category of type A 2.1 occupancy and classified as Type II 1-hour construction.
- The floor area of the Premises shall have lease measurements provided in Exhibit "A" of the Tenant lease.
- The demising partitions may be on column centerlines, in which case the column and the structural braces are thicker than the wall and will extend into the Premises.
- Exterior walls (if and where they occur in the Tenant Premises) shall be metal studs/masonry or other materials as Landlord's architect shall select.
- Any alterations, additions or reinforcements to Landlord's structure required to accommodate Tenant's Work shall be performed only at Tenant's expense with Landlord's structural engineer and Landlord's prior written approval.

## UNDERGROUND WORK

- All Tenant intrusive construction work taking place within Building 3, Building 7, and Building 8 (Parcel B) must be conducted in accordance with the New York State Department of Environmental Conservation (NYSDEC)-approved Site Management Plan (SMP). The SMP details institutional and engineering controls required for Parcel B to address residual contamination remaining after remediation under the Brownfield Cleanup Program (BCP). To comply with the SMP, Tenant is responsible for notifying Macerich management and providing required submissions to Macerich and their remedial engineer at least 15 days prior to intrusive construction. The notification procedure and required submissions are described below:
- At least 15 days prior to ground intrusive construction:
  - Tenant must notify Macerich management about the proposed intrusive activities; and Macerich management will notify the remedial engineer.
- Concurrent with the notification, tenant should provide the following documents to Macerich and remedial engineer:
  - Detailed plans indicating the extent of concrete cutting, disruption of materials below slabs/asphalt/clean cover, etc.
  - OSHA certificates for equipment operators and laborers (if deemed necessary), in accordance with the Health and Safety Plan (HASP) previously prepared for the site.
  - Proposed plan for off-site disposal or on-site reuse of excavated materials.
  - Proposed sources and clean certifications for any imported materials for back fill purposes.
  - Procedures for soil stockpiling (i.e., protection of stockpile surfaces, and covering); and
  - Procedures for odor, dust, and nuisance control.
- Proceeding with intrusive work without the proper notifications and without following the procedure outlined above is in violation of NY State laws and could result in a revocation of the NYSDEC Certificate of Completion (COC).

## EXIT CORRIDORS

- Distribution of utilities through a newly constructed or an altered exit passageway is prohibited except for equipment and ductwork specifically serving the exit passageway, sprinkler piping, standpipes, electrical raceway for fire department communication and electrical raceway serving the exit passageway.

# FOOD CRITERIA CONTENT OVERVIEW

## 2.1

### RESTAURANTS

DETAILS SPECIFIC DESIGN, SIGNAGE, AND TECHNICAL REQUIREMENTS FOR FOOD TENANTS WITH INTERIOR OR EXTERIOR FACING RESTAURANT SERVICE.

#### SECTIONS OF INTEREST

- INLINE CRITERIA*  
Standard design, technical, and sign requirements in addition to the contents in this section.
- DESIGN INSPIRATION*  
Provides design inspirations for visual aesthetics.
- BUILDING DETAILS*  
Includes Property reference photos and specific Storefront design details.
- PROPERTY INFO*  
Includes information on the Property's building codes, area permitting, and required contractors.
- SUBMITTALS*  
Outlines requirements on how and what to compile for submittals to the Landlord for design reviews.

**This Food Tenant Criteria is specifically tailored to highlight unique technical and design requirements for Tenant's cooking, preparing, and selling food products.**

Through the application of the Criteria guidelines, Food Tenants will produce distinctly original designs unique to their brand and the Center. These guidelines are to help maintain a consistent design quality while still allowing each Tenant to achieve a high level of expression and diversity.

The goal is to enhance the shopping experience for our Customer through the quality and artfulness of Tenant design.

This Criteria will often point to the [INLINE RETAIL CRITERIA](#), as several requirements and design concepts are shared.

The Tenant's Architect is encouraged to contact the Landlord's Tenant Coordinator to discuss any specific design intentions prior to commencing design work. The Tenant Coordinator will strive to resolve all outstanding design issues. However, the Tenant Coordinator may, in the best interest of the Center, reject any aspect of the Tenant's design.

If an acceptable design cannot be agreed upon, the Landlord may, at the Tenant's expense, provide an additional concept Storefront design for consideration.



# RESTAURANTS > CONTENTS

- DESIGN**
  - STOREFRONT / PREPARATION AS THEATER*
  - CONTROL AREAS / SEATING*
  - EXTERIOR*
- SIGNAGE**
  - STOREFRONT / MENU BOARDS*
- TECHNICAL**

## SECTIONS OF INTEREST

- INLINE CRITERIA*

Includes standard design, technical, and sign requirements in addition to the contents in this section.
- DESIGN INSPIRATION*

Provides design inspirations for visual aesthetics.
- BUILDING DETAILS*

Includes Property reference photos and specific Storefront design details.
- PROPERTY INFO*

Includes information on the Property's building codes, area permitting, and required contractors.
- SUBMITTALS*

Outlines requirements on how and what to compile for submittals to the Landlord for design reviews.

**The Restaurant Criteria provides key technical information and design requirements to ensure your interior or exterior facing restaurant food service enlivens the consumer experience and interfaces with the Center.**

This Criteria will often point to the [INLINE RETAIL CRITERIA](#) as several requirements and design concepts are shared. The content in this section highlights the unique concepts for food service design.

The Tenant and the Tenant's architect assume the following important obligations:

- Fulfill the intent of the Criteria both in concept and in detail.
- Determine and respond to the actual physical conditions of the Tenant's location.
- Maintain and enhance the high standards of quality established in the construction of the Center.
- Ensure the quality of execution of all design material, finish, and detail concepts in the construction of the Tenant's improvement.
- Provide the required detail at all transitions from Tenant Storefront to neighboring Storefronts, as well as to the base building.



## > DESIGN > STOREFRONT / PREPARATION AS THEATER

Restaurant Food Tenants must adhere to the design requirements found in the [INLINE DESIGN CRITERIA](#).

In addition, Tenants serving food in their space must also adhere to the following:

### **GENERAL STOREFRONT AND DESIGN**

We encourage a cohesive presentation of the brand within the context of the whole Mall design, while the individual brand is important and the two must harmonize. Design should be tailored to its location both within the community and the whole Center's aesthetics.

Restaurants may face both the interior and the exterior, and are often located adjacent to a Mall entry. The exterior and the interior are subject to different Criteria standards, both for presentation and signage.

Interior restaurants oftentimes have a waiting area within the common space.

- If needed these must be shown in the submissions and be approved by Landlord. They must be coordinated with common area needs and code requirements.

### **PREPARATION AS THEATER**

Tenant's offering a peek into the making of food, by nature, include the Customer and make for an authentic experience. This inclusion of the Customer will increase engagement and is highly encouraged.



## > CONTROL AREAS / SEATING

### CONTROL AREAS

The DCA is the area at the front of the Tenant space that extends from the lease line to all points 6'-0" into the space. It should convey excitement and give the consumer a reason to engage.

Exposed patios are encouraged however, they should not extend beyond the lease line. In special cases there may be opportunity to extend the patio but it must be in compliance with all common Mall code and circulation requirements.

Projection or canopies may increase the visibility of the Storefront over seating areas. They also help with lighting the Storefront.

In addition to the general DCA Criteria for inline stores the following requirements must be met:

- All patio rails, reception podiums, waiting areas, menu presentations, lighting, heating, visible banquet detailing, and material palettes must be presented for review and approval.
- Common Mall flooring must be maintained. Coordinate with Landlord design if railings or other elements will have an effect on the flooring.

### SEATING

Where interior seating is needed or desired, it is suggested that the enclosure line be moved into the lease space by approximately twelve (12') feet.

Seating design requirements include:

- Patio seating must be separated from the common area circulation in the Mall by a low barrier. A layout will be required for review.
- All visible furniture must be reviewed by the Landlord for suitability both aesthetically, as well as for performance specifications.
- Tenant is responsible to confirm additional requirements with the local authorities for any railing or barrier for the Tenant's proposed area.



## > EXTERIOR

Restaurants with exterior Storefronts will be subject to the general Criteria in this manual, for aesthetics.

Exterior design should be tailored to its location both within the community as well as the whole Mall and its aesthetics.

### SITE PLANS

- A Site Plan must be submitted that includes all required calculations for GLA, GBA, and parking requirements.
- Site Circulation must be included showing the adjacent intersections, driveways, drive directions, and dimensions of all access points.
- Photos of adjacent and onsite conditions may be required by Ownership for the review process.

### AMENITIES

- Planters, heat lamps, tables, chairs etc., must be submitted for approval. All amenities must be commercial grade and suitable for outdoor use.
- Pendant or sconce lighting must be submitted for approval by Landlord.
  - Lighting plans of canopies and trellis are available in Landlord supplied base drawings.
- Umbrellas are only allowed in the designated areas and cannot overhang into the public right-of-way.
  - Umbrellas should be small in scale (maximum 6'-0" in diameter) and no more than 9'-0" high at the peak.
  - Wood or metal are the only acceptable materials for the umbrella structure. No insignia, graphics or text are permitted on the umbrella fabric.
  - The umbrella fabric must be flame retardant material in a color approved by Landlord's Tenant Coordinator.

### EXTERIOR PATIOS

- Any changes to an existing patio must be approved by Landlord. Tenant is responsible to confirm the requirements with the local municipality for proposed use.
- Temporary elements such as greeting stands, or waiting areas must be submitted for review.
- Confirm code height and density of railings for any necessary barriers.
- Patio layouts with adjacent circulation dimensions must be included in the first submittal of documents for design review.
- Railing design details should be submitted with the concept and construction packages for approval by the Landlord design team.





## > SIGNAGE > PRIMARY / MENU BOARDS

### **PRIMARY STOREFRONT SIGN**

Inline and Restaurant Food Tenants must adhere to the Signage requirements found in the [INLINE SIGN CRITERIA](#).

Exterior signage must adhere to the requirements established by the local municipality.

### **MENU BOARDS**

Menu board applications must be a part of the overall store design. We strongly encourage using a graphic designer to create your boards.

### **DESIGN REQUIREMENTS**

The following requirements must be used when designing your menu boards:

- All menu boards must be submitted to the Landlord for review and approval prior to start of Tenant construction.
- Professional quality drawings/renderings must be submitted for approval.
- Design shall be an integral part of the graphics and complimentary to primary signage.
- Overall width of menu board cannot exceed 60% of overall Storefront width.
- Mounting height to be a minimum of 7'-0" to bottom of sign with maximum height of 10'-0" and held a minimum of 10" from edge of walls.
- The menu board must be non-reflective to avoid glare.

### **PERMITTED ELEMENTS**

Permitted menu board design elements include:

- Artisan type quality such as chalkboards, painted wood or unusual materials and combinations of material.
- Frames, holders, text, photo displays, lighting and materials must be creatively designed.
- High quality digital printouts for menu board may be approved at Landlord's discretion.
  - Photographs used in menu boards must be professionally produced and approved by the Landlord.
  - Plasma screens cannot be surface mounted.
- Externally illuminated menu boards are allowed.
  - Tenant is required to submit light fixture cut sheet for approval.

### **PROHIBITED ELEMENTS**

Not permitted menu board design elements include:

- Standard factory designs.
- Standard surface-mounted box-type internally illuminated menu boards.



## > TECHNICAL

Inline and Restaurant Food Tenants must adhere to the technical requirements found in the [INLINE TECHNICAL CRITERIA](#).

In addition to the requirements detailed in the Technical Criteria, Tenants cooking food in their space must adhere to the following:

### **SPECIAL REQUIREMENTS FOR RESTAURANT TENANTS**

#### **LANDLORD PROVISIONS**

- Large restaurant tenants (greater than 1,000 sq. f.) shall be provided with provisions for kitchen exhaust, dishwasher exhaust and makeup air.
- Small restaurant tenants (less than 1,000 sq. f.) shall be provided with provisions for dishwasher exhaust only.

#### **KITCHEN EXHAUST**

- Spatial provisions for kitchen hood exhaust duct risers shall be made, but no ductwork or exhaust fans shall be provided by the Landlord.
- Kitchen exhaust fans shall be located on the roof, the exact location shall be coordinated with the Landlord prior to installation.
- Tenant shall install at its sole cost and expense around all roof exhaust fans the UL Listed G2 Guard Rooftop Defense System by Facilitec (contact Facilitec at 800-282-8273; address: 3851 Clearview Court, Gurnee, IL 60631), or a substitute approved by Landlord. Tenant shall be responsible for obtaining a maintenance agreement for the upkeep of the G2 Grease Guard Rooftop Defense System (or the approved substitution), and a copy of the maintenance agreement must be submitted to the management office annually.

#### **KITCHEN MAKEUP AIR**

- Spatial provisions for makeup air ducts shall be made, but no ductwork or exhaust fans shall be provided by the Landlord.
- Makeup air equipment shall be gas-fired roof-mounted and shall be provided by the restaurant tenant.

#### **DISHWASHER EXHAUST**

- Spatial provisions for dishwasher exhaust duct risers shall be made, but no ductwork or exhaust fans shall be provided by the Landlord.

#### **OTHER**

- All exhaust hoods shall be commercial grade. Hoods for grease-producing equipment shall be provided with grease filters/baffles and fire extinguishing systems.
- All exhaust ductwork must be installed in conformance with NFPA Bulletin 96, and the NYC Building Code. Location of exhaust ductwork penetrations must be approved by the Landlord prior to installation.
- A grease containment system is required for food service installations. The Tenant will provide the Landlord with a copy of the maintenance agreement for the grease containment system.

### **SPECIAL REQUIREMENTS FOR ODOR PRODUCING TENANTS**

The following special requirements apply to odor producing Tenants (including but not limited to hairstyle shops, pet shops, restaurants, fast food use shops or any other premise at the Landlord's discretion):

- Tenant is required to furnish and install the necessary equipment to remove or neutralize any odors. This work will be approved in writing by the Landlord and at the sole expense of the Tenant.
- The tenant shall provide additional makeup air, as required to balance supplemental exhaust systems. This may come in the form of increased air supply from the base building system (where approved by the Landlord), or from an additional makeup air unit installed by the tenant. All costs incurred by the additional makeup air will be the responsibility of the Tenant.
- Tenants shall operate HVAC system between 5% and 10% negative pressure (when referenced to adjacent areas) and shall provide air balance report prior to store opening, and on an annual basis as required by the Landlord.

# KIOSK CRITERIA CONTENT OVERVIEW

3.1

## DESIGN INSPIRATION

PROVIDES DESIGN INSPIRATIONS AS TO WHAT KIND OF KIOSK DESIGNS CAN BE PRODUCED.

3.2

## DESIGN ELEMENTS AND REQUIREMENTS

DETAILS DESIGN CONCEPTS AND REQUIREMENTS TO INCORPORATE INTO THE OVERALL KIOSK DESIGN.

3.3

## FOOD DESIGN ELEMENTS AND REQUIREMENTS

DETAILS SPECIFIC DESIGN ELEMENTS AND REQUIREMENTS FOR KIOSKS SELLING AND COOKING FOOD.

3.4

## TECHNICAL

DETAILS THE TECHNICAL DESIGN REQUIREMENTS TO INSURE THE KIOSK INSTALLATION INTERFACES WITH THE UTILITIES AT THE CENTER.

3.5

## PROCESS

PROVIDES AN OVERVIEW OF THE DESIGN, CONSTRUCTION, AND INSTALLATION OF KIOSKS.

3.6

## DESIGN DETAILS

SPECIFIC DESIGN DETAILS REQUIRED TO BE ADOPTED AND SHOWN IN THE KIOSK DESIGN SUBMITTAL DRAWINGS.

### SECTIONS OF INTEREST

- DESIGN INSPIRATION**  
Provides visual inspirations for design aesthetics.
- PROPERTY INFO**  
Includes information on the Property's building codes, area permitting, and required contractors.
- SUBMITTALS**  
Outlines the requirements on how and what to compile for submittals to the Landlord for design reviews.

**Macerich strives to differentiate its shopping environment through fresh, innovative design and unique retail offerings. We transform everyday shopping into a truly unexpected and exhilarating experience.**

Innovative design has proven to stimulate customer interest which in turn drives sales. For Macerich and kiosk Tenants to achieve this goal, we ask our Tenants to fabricate a high quality, experiential retail design that is cohesive and complimentary to the overall Shopping Center environment.



# DESIGN INSPIRATION > CONTENTS

- URBAN
- ARTISAN
- WHIMSICAL
- INVITING
- ARTSY
- THEATRICAL

### SECTIONS OF INTEREST

The following sections provide additional details and requirements related to this Criteria:

- DESIGN INSPIRATION*  
Provides additional visual inspirations for design aesthetics.

### GET INSPIRED!

The following inspirations are intended to help you visualize what kind of kiosk design can be produced. These aesthetic examples encourage bold design to draw Customers and enliven the common area visuals of the Center. By the nature of their prominent locations, kiosks require great design and an attention to detail to ensure high quality retail experiences.



> URBAN

# URBAN

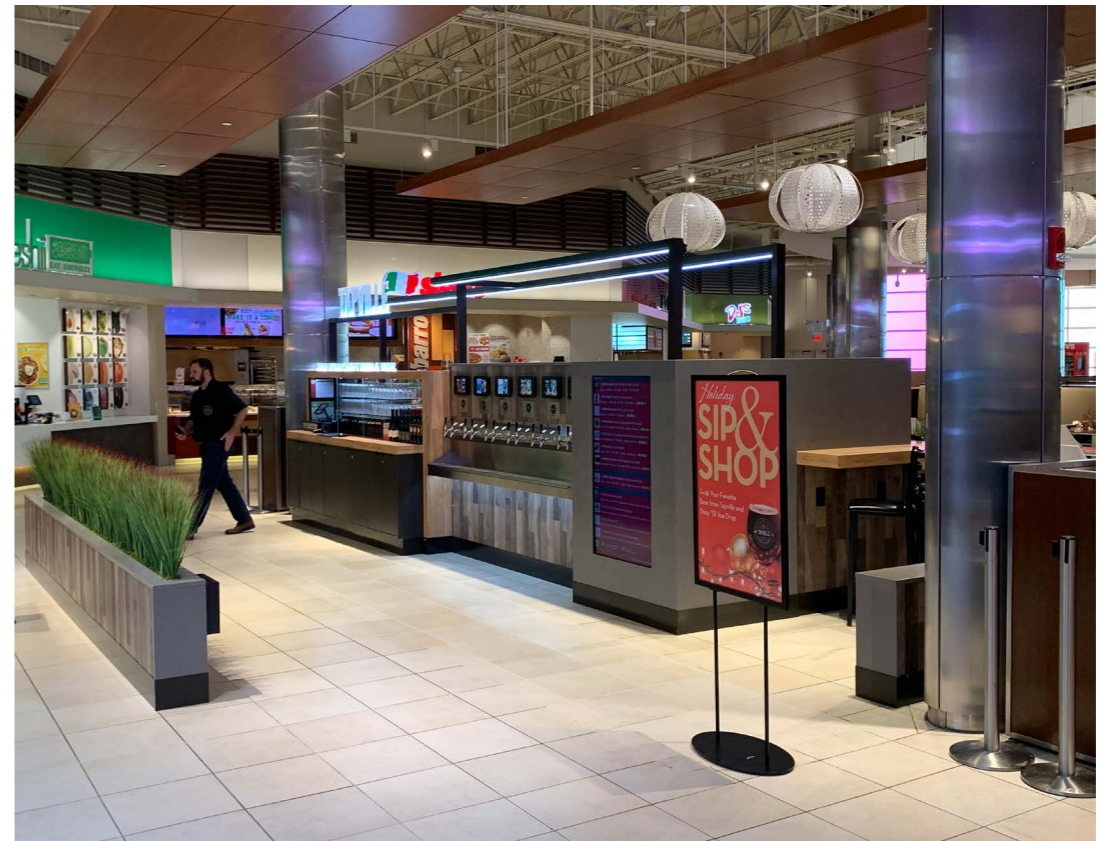

**EDGY, FUNKY, STREET SAVVY STYLE, INDUSTRIAL**

> ARTISAN

# ARTISAN

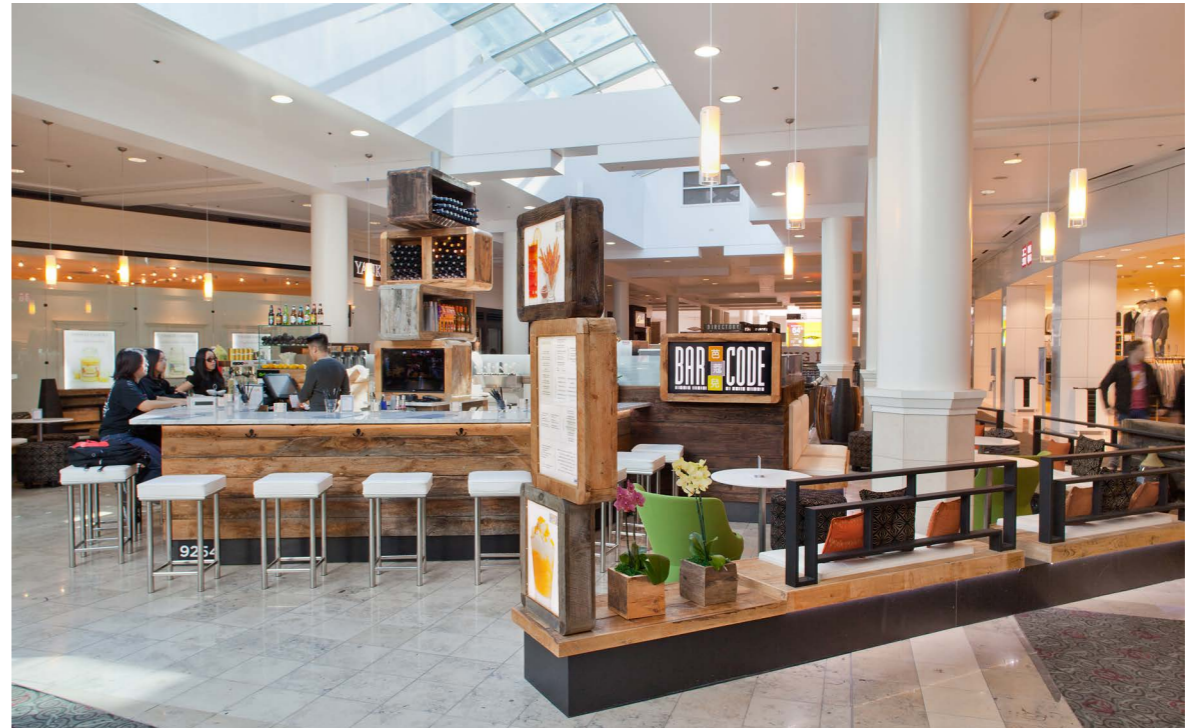
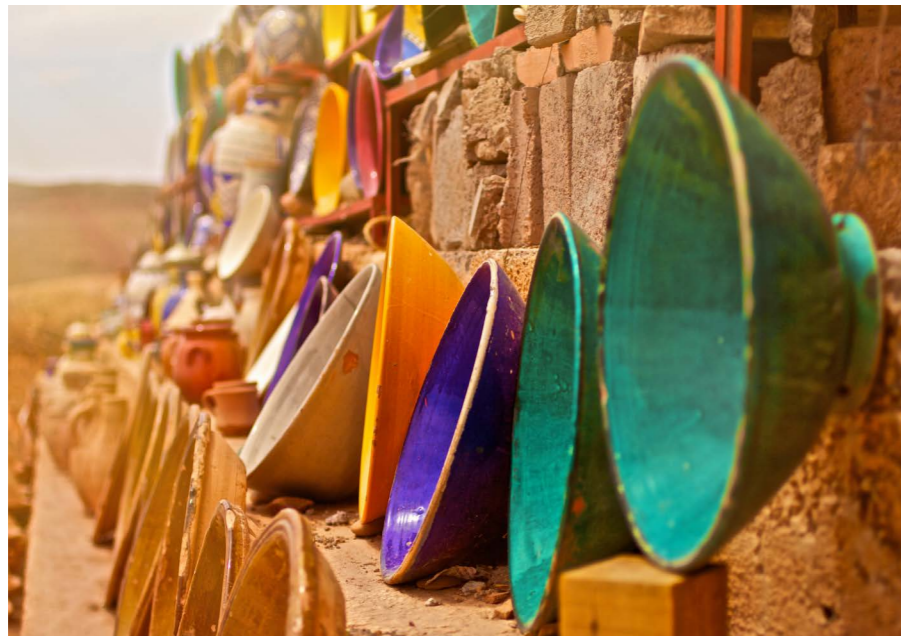

NATURAL, SOPHISTICATED, UNIQUE

> WHIMSICAL

# WHIMSICAL



UNEXPECTED, PLAYFUL, COLORFUL

> INVITING

# INVITING



WARM, CALM, OPEN, SOFT



> ARTSY

# ARTSY

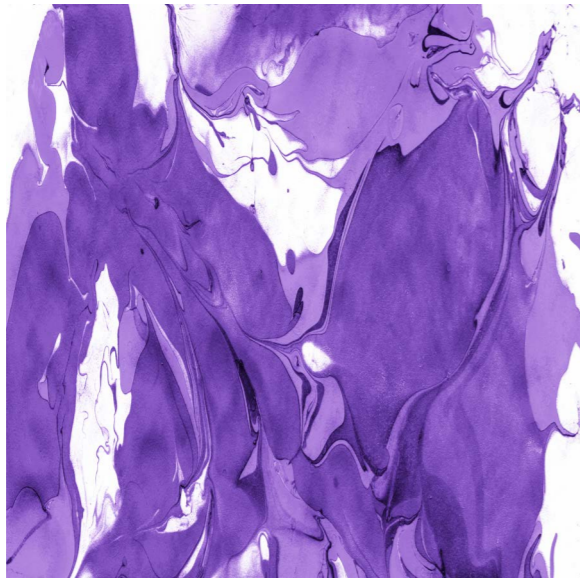

**QUIRKY, AVANT GARDE, SURPRISING**

> THEATRICAL

# T H E A T R I C A L



DRAMATIC, HIGH CONTRAST, MOVEMENT

## > KIOSK SIGN CRITERIA

### KIOSK SIGN CRITERIA



EXISTING KIOSKS AND CURRENT SIGNAGE

## > KIOSK SIGN CRITERIA > GENERAL

### GENERAL SIGN CRITERIA:

1. Temporary signs for sales, inside or outside, are not permitted.
2. Freestanding pedestals, advertising placards, banners, sign pendants, insignia, trademarks, web addresses and tag lines are not permitted. All signage must be integrated into the kiosk design and approved by the Landlord.
3. Exposure of any light bulbs, raceways, cables etc., are not permitted. Light sources must be concealed within the sign.
4. The signage should enhance the storefront design and clearly communicate your brand and offerings.
5. The content of the sign is limited to the Tenant's Trade name.
6. The placement of the primary sign is limited to the two long sides of the kiosk. (one on each side). The sign height cannot exceed 24". The sign shall not exceed 60% of the storefront width. Brand logos cannot exceed 24" square. The sign must be dimensional and lit. (internally illuminated, indirect or halo lit). Sign must be applied to the fascia of the roof with the bottom of the sign flush with the bottom of the fascia. Box signs are not allowed.
7. Signage on glazing above the 3'-6" height MUST be of a translucent print. (similar to a frosted glass), and can only be applied on the back and sides of the kiosk. No graphics permitted above 3'-6" on the front of Storefront. The graphic can be a vinyl applied directly to the inside of the glass. An "ombre" (fade out), vinyl print is preferred. (Refer to examples on following page.)

The Landlord reserves the right to disapprove any sign / graphic design that does not comply with the sign criteria.

REFER INLINE SIGN CRITERIA FOR ADDITIONAL SIGN REQUIREMENTS.

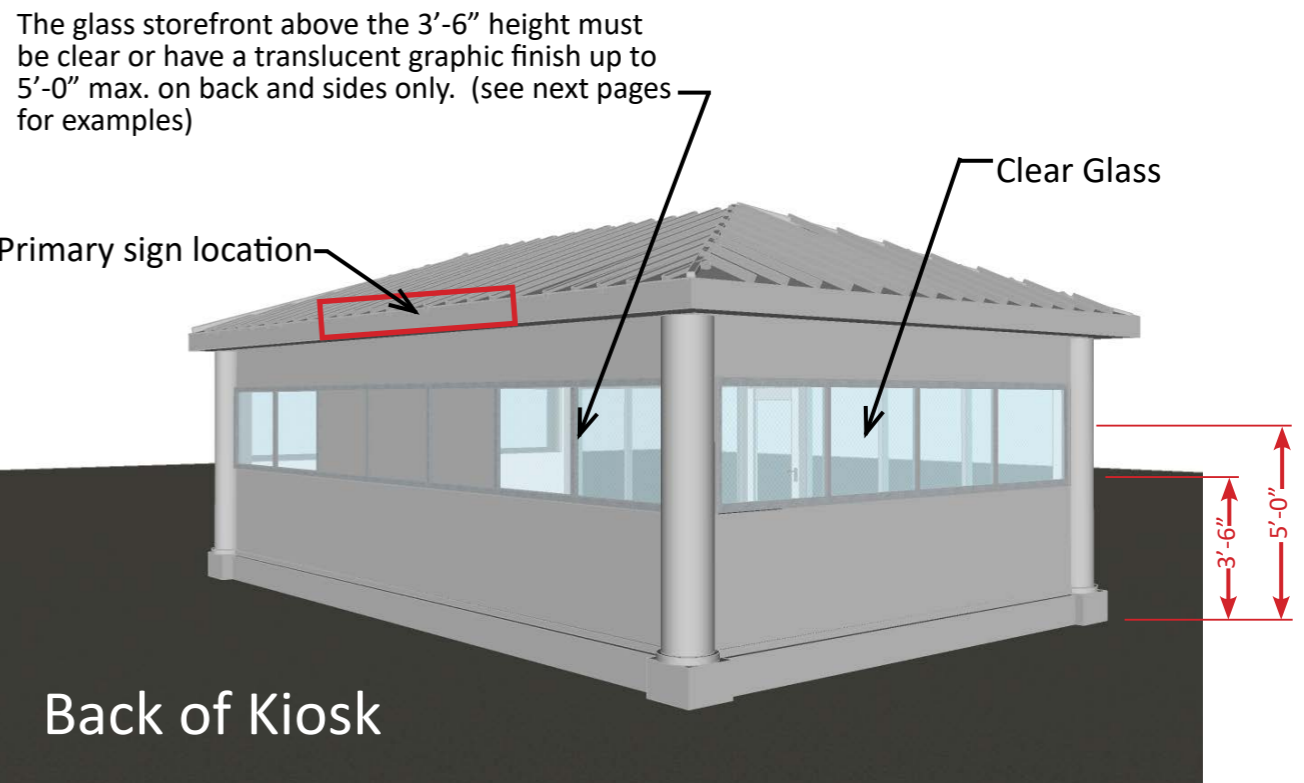
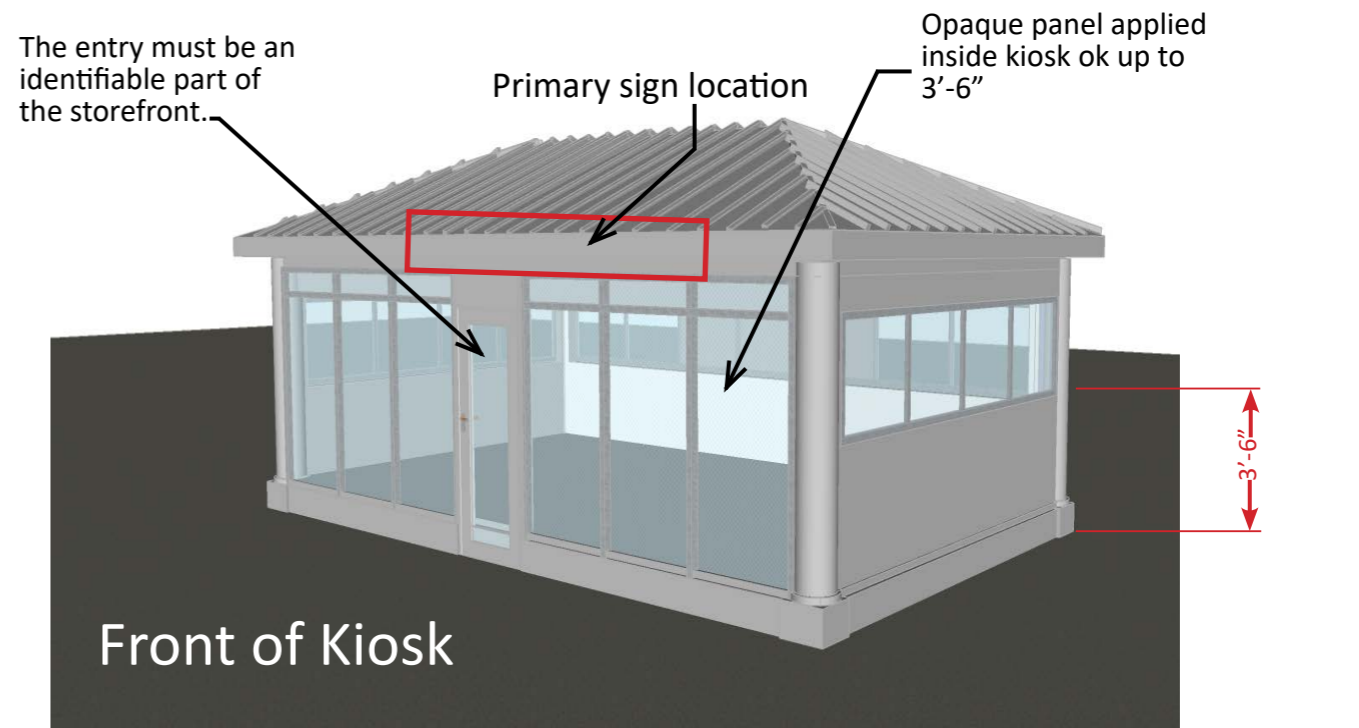

> KIOSK SIGN CRITERIA > EXAMPLES



> KIOSK SIGN CRITERIA > EXAMPLES

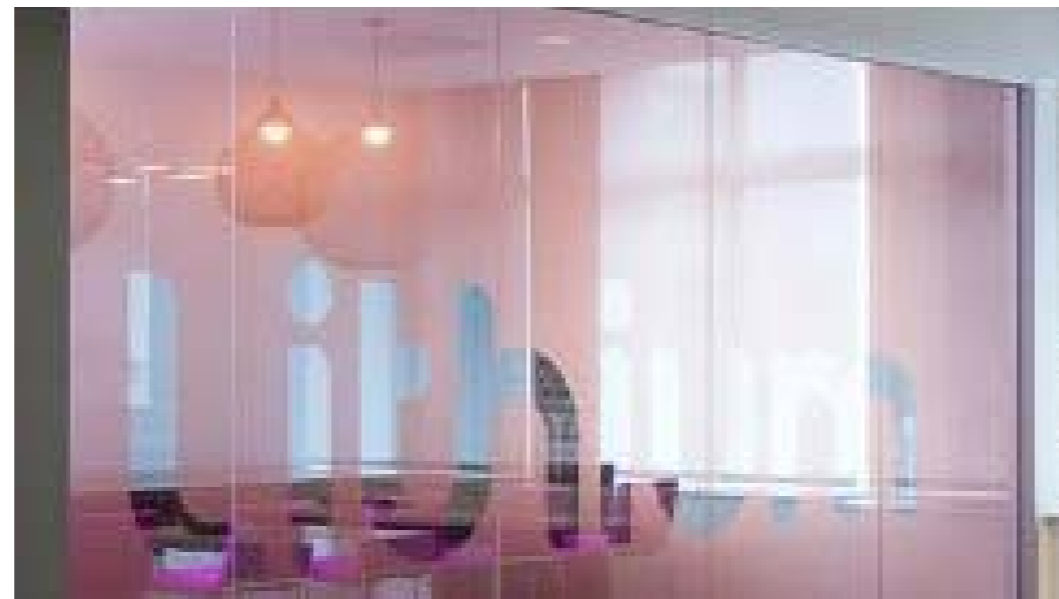
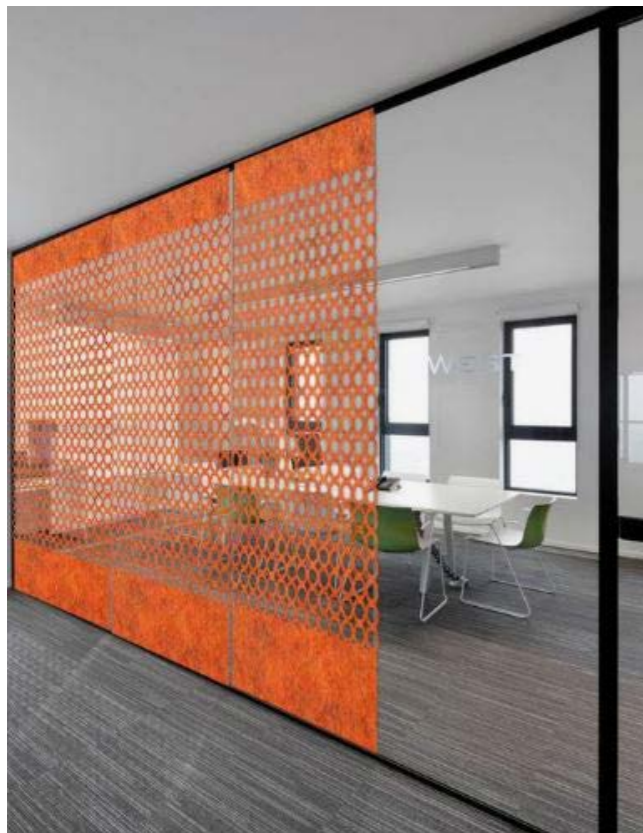

# FOOD DESIGN ELEMENTS AND REQUIREMENTS > CONTENTS

- FOOD DISPLAY**
- FOOD PREPARATION AREA**
- MENU BOARDS**
- CONDIMENTS AND UTENSILS**

## SECTIONS OF INTEREST

The following sections provide additional details and requirements related to this Criteria:

- DESIGN INSPIRATION*  
Provides visual inspirations for design aesthetics.
- PROPERTY INFO*  
Includes information on the Property's building codes, area permitting, and required contractors.
- SUBMITTALS*  
Outlines the requirements on how and what to compile for submittals to the Landlord for design reviews.

## A FEAST FOR YOUR EYES!

This section provides an overview of the specific design elements and requirements to consider for a “wet” food producing kiosk. It is important to embrace the cooking and display of food as an integral design element to your kiosk. Food is a great tool to entice the consumer.



## > FOOD DISPLAY

### FOOD DISPLAY PRESENTATION

We encourage you to incorporate food display of your goods to showcase your brand to Customers. Presenting freshly made options from the menu will entice the eyes of your customer and provide an instant way to purchase an item. Labeling your items helps identify your offerings.

- Food displays must be appetizing and behind clean and clear glass.
- Labels should accent the design of your kiosk.
- Signage should be professionally printed on card stock and utilize proper display methods.



**DISPLAY THE GOODS IN AN APPETIZING MANNER.**





## > FOOD PREPARATION AREA

### FOOD PREPARATION AREA

Visual food preparation is an added value to your brand experience, resulting in excitement and interaction for the Customer.

- Obstructive overhead canopies are not permitted. An alternative solution to an overhead canopy should be used if one is required by the Health Department.
- Check local building codes for requirements on plumbing venting inside a wall or if it occurs on the exterior wall.
- Odor producing equipment is not permitted. Tenants must enclose all odor within their premise.

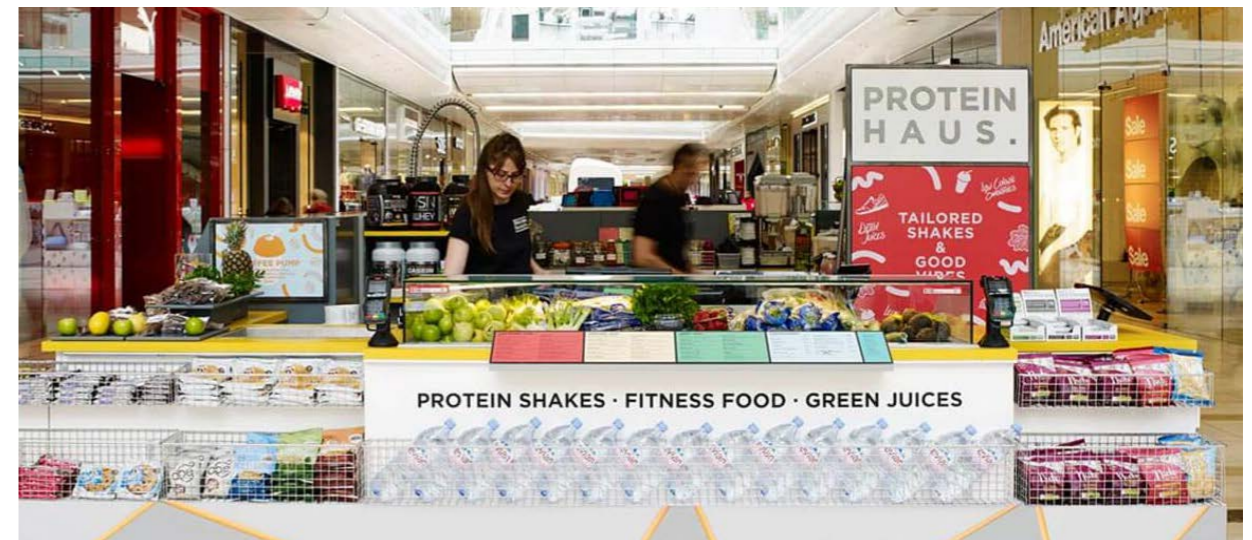

## > MENU BOARD

### MENU BOARD

Your menu board is a vital brand element to communicate your product to the Customer.

- Design must be integrated and coherent with the retail design.
- Loose menu boards are not permitted.
- The top of the menu board may not exceed a height of 5'. The only exception is when the menu board is located on a pylon.



## > CONDIMENTS & UTENSILS

### CONDIMENTS AND UTENSILS

Condiments, utensils, napkin holders, etc., can be an eyesore if not properly accounted for in the kiosk design.

- Items must be integrated seamlessly into the overall kiosk design.
- Loose items on the countertops are not permitted.



# > ELECTRIC / DATA / PLUMBING / STORAGE

## OVERVIEW

The Technical Criteria is designed to provide building details and design requirements for the Property's technical systems.

It is the Tenant's responsibility to verify existing conditions and comply with all applicable codes and standards for all technical systems.

Tenants are required to adhere to the full Criteria during their design and construction.

## ELECTRIC

Most retail kiosk spaces are typically provided 20 amps of low voltage power stubbed into a J-Box under the floor. In certain kiosk locations, more power exists. It is the responsibility of the Tenant to field verify the amount of existing power in their Premises, to ensure it suits the Tenant's needs, prior to signing the Lease.

Tenant kiosk installations are typically required to tap into the provided power, and distribute inside their kiosk. The following requirements must be met:

- **IDENTIFY** all Tenant equipment in the Mall electric room with clear labels that include the Tenant name and space number.
- **CUTTING AND PATCHING** must be provided by Tenant.
- **MATERIAL AND EQUIPMENT** must be new and of a commercial grade with UL Labels and where such labeling applies.
- **WATERTIGHT FLOOR BOXES** are required.
- **EXPOSED WIRING** is not permitted. All wiring of any type must be installed in conduit or must be metal clad cable (MC). Metal clad cable will only be allowed for concealed branch circuit wiring within the demised premises. Flexible conduits must be used for connections to vibrating equipment.
- **EXPOSED LOW VOLTAGE** wiring must be plenum graded.

## DATA AND COMMUNICATIONS

Kiosk spaces are typically provided an empty conduit with a pull string stubbed into a J-Box under the floor.

- **DATA SETUP AND SERVICE INSTALLATION** is the Tenant's responsibility to coordinate direct through Granite Grid. Other data providers are not permitted at this property as they do not have an access agreement in place.
- **TELEPHONE DEMARC WORK** must be performed by Landlord's approved telephone subcontractor, Granite Grid.
- **TELEPHONE SERVICE** is the Tenant responsibility to coordinate directly through Granite Grid and install within their premises.

## PLUMBING

Kiosk spaces may or may not have existing wet utilities. It is the responsibility of the Tenant to field verify the wet utilities in their Premises, to ensure it suits the Tenant's needs, prior to signing the Lease.

Tenant kiosk installations are typically required to core into the floor, tap into the provided plumbing, and distribute inside their kiosk. The following requirements must be met:

- **GARBAGE DISPOSALS** are not allowed.
- **HAIR RECEPTORS** must be installed on all sinks, basins, and special sanitary units which may in any way receive human or animal hair.
- **GREASE INTERCEPTORS** must be installed within the kiosk footprint.
- **KITCHEN SINKS** including pot sinks, scullery sinks, pre-wash sinks and other kitchen units must be connected to a grease trap as per code.
- **DISHWASHERS** may not be connected to grease trap.
- **OIL COLLECTION AND HAULING SYSTEM** is required for Tenants with fryers or other grease/oil generating equipment that does not run through an interceptor. Landlord does not provide a centralized collection point.
- **FLOOR PENETRATIONS AND PLUMBING** by Tenants must be coordinated with the Landlord.

# PROCESS > DESIGN KICKOFF / DESIGN SUBMISSION / PERMITTING & CONSTRUCTION

This section provides a brief overview of the design, permit, and installation process steps to get your kiosk open.

### DESIGN KICKOFF

We want to help you create an incredible kiosk to maximize your brand’s potential. Your Tenant Coordinator will contact your team to schedule a design kickoff call. The purpose of this call is to collaborate on your design intent and help you understand the requirements in this Criteria.

### DESIGN SUBMISSION AND REVIEW

Requirements on how and what to submit for the Landlord drawing review of your kiosk can be found in the [SUBMITTALS CRITERIA](#).

### PERMITTING AND CONSTRUCTION

An overview of both the City/Municipalities permit process and the Landlord’s construction requirements can be found in [PROPERTY INFO](#).

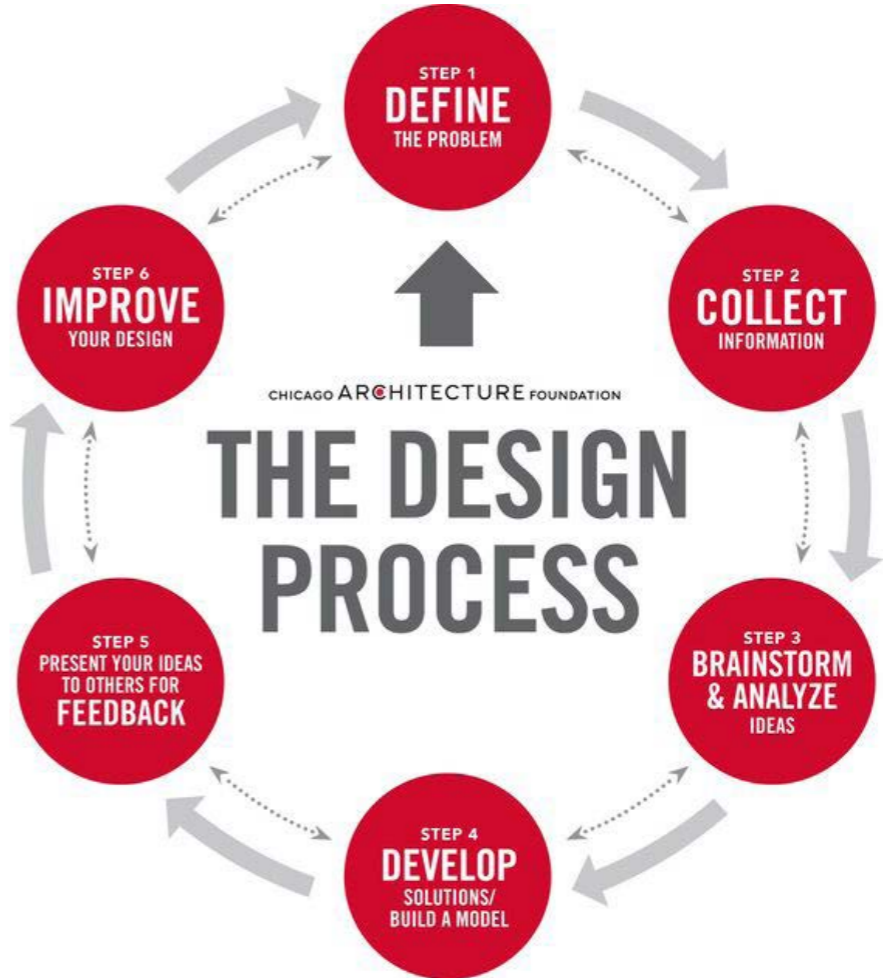

# DESIGN DETAILS > GLASS SHROUD / GATE

The following design details are required to be shown in your final design drawings. These details will help to ensure your kiosk is sturdy and built to last.

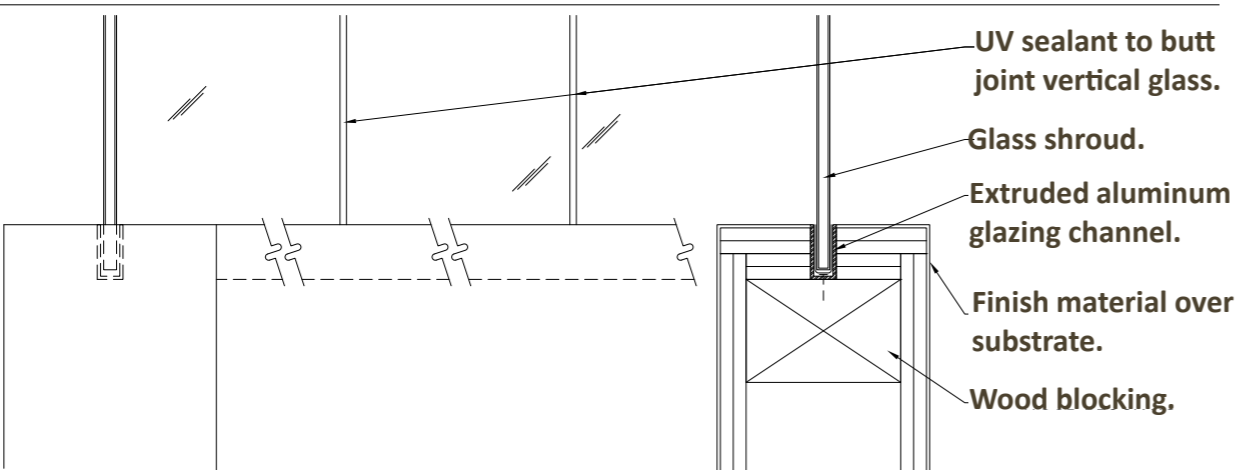

**GLASS SHROUD DETAIL**

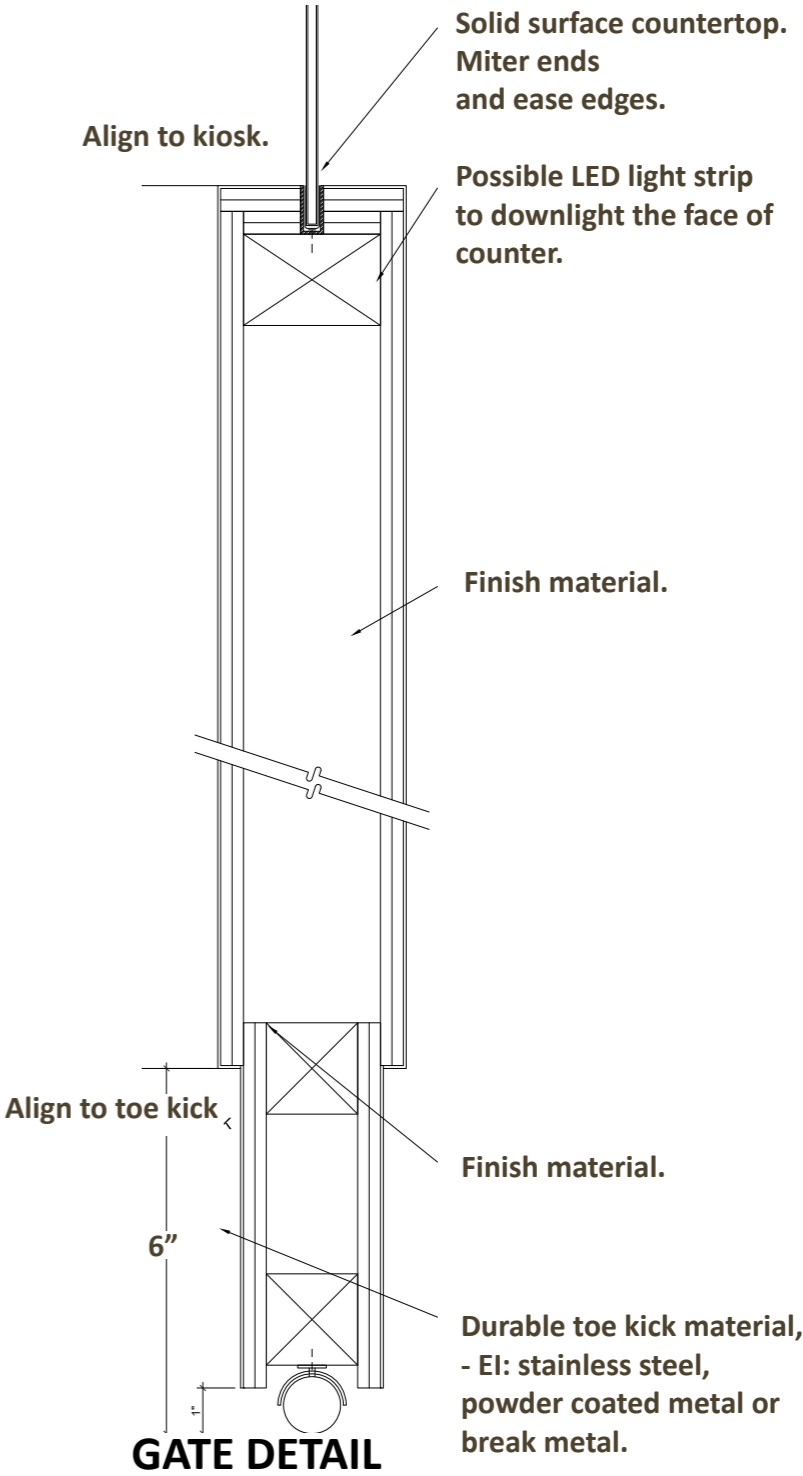

**GATE DETAIL**

# DESIGN DETAILS > CORNER / GRAPHIC FRAME

Note: Can be used for vertical corner only.

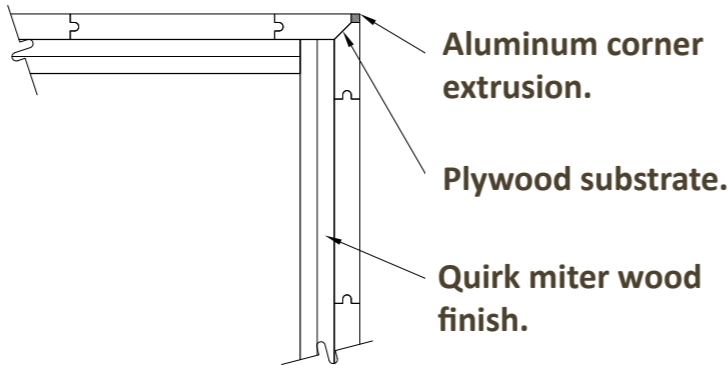

**CORNER DETAIL**

Note: Can be used for vertical corner only.

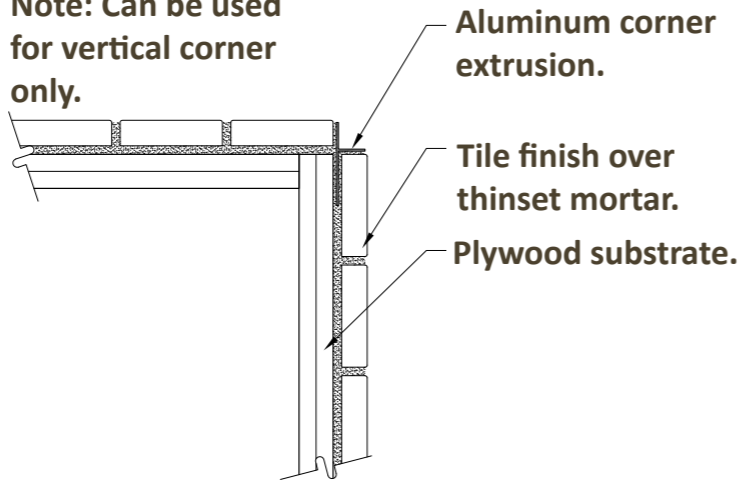

**CORNER DETAIL**

Note: For interchangeable frameless graphic panels, change graphic from back via concealed hinges and reveal details. (for back lit panels as well to replace lights). Use concealed / magnet activated locks to secure door.

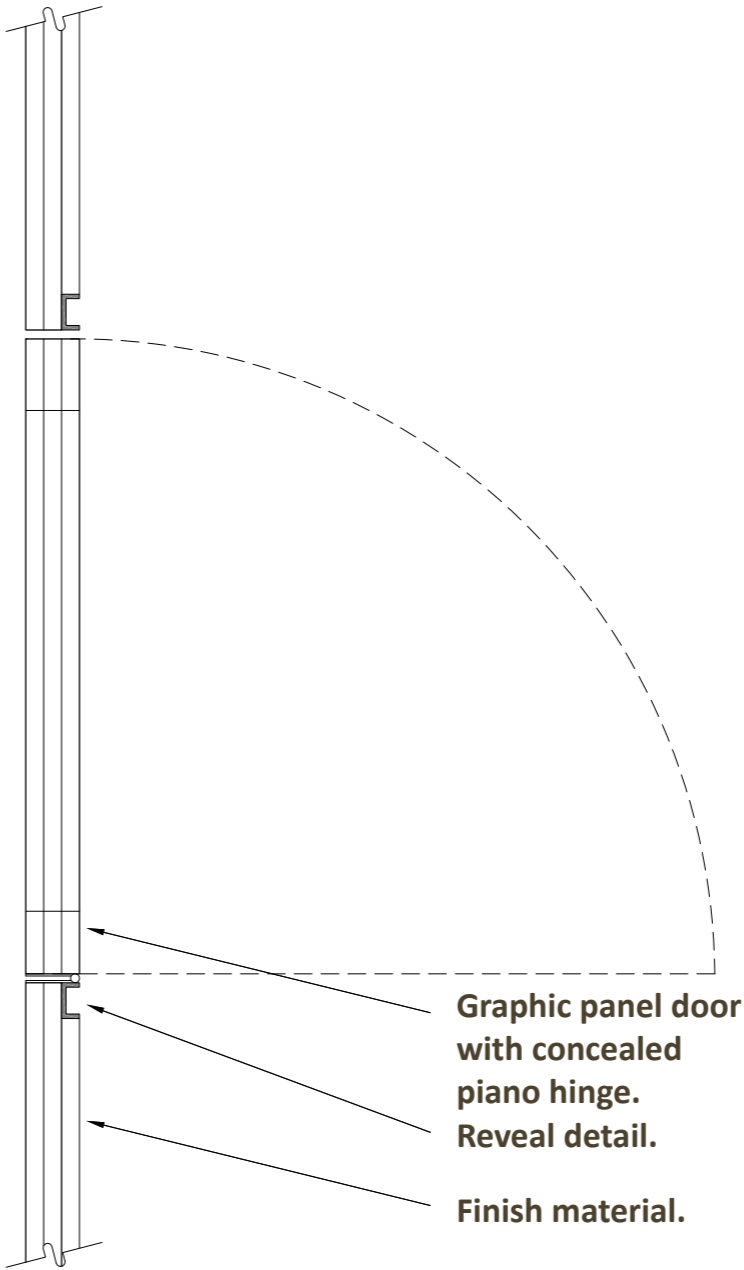

**GRAPHIC FRAME DETAIL**

# MALL ZONES > OVERVIEW MAP

This section provides design details, requirements, and visual references specific to the different buildings located within Atlas Park. These are additional design requirements that must be followed to ensure your Store correctly interfaces with the immediate surroundings. Click or tap on a colored Zone to navigate directly to that building's details.

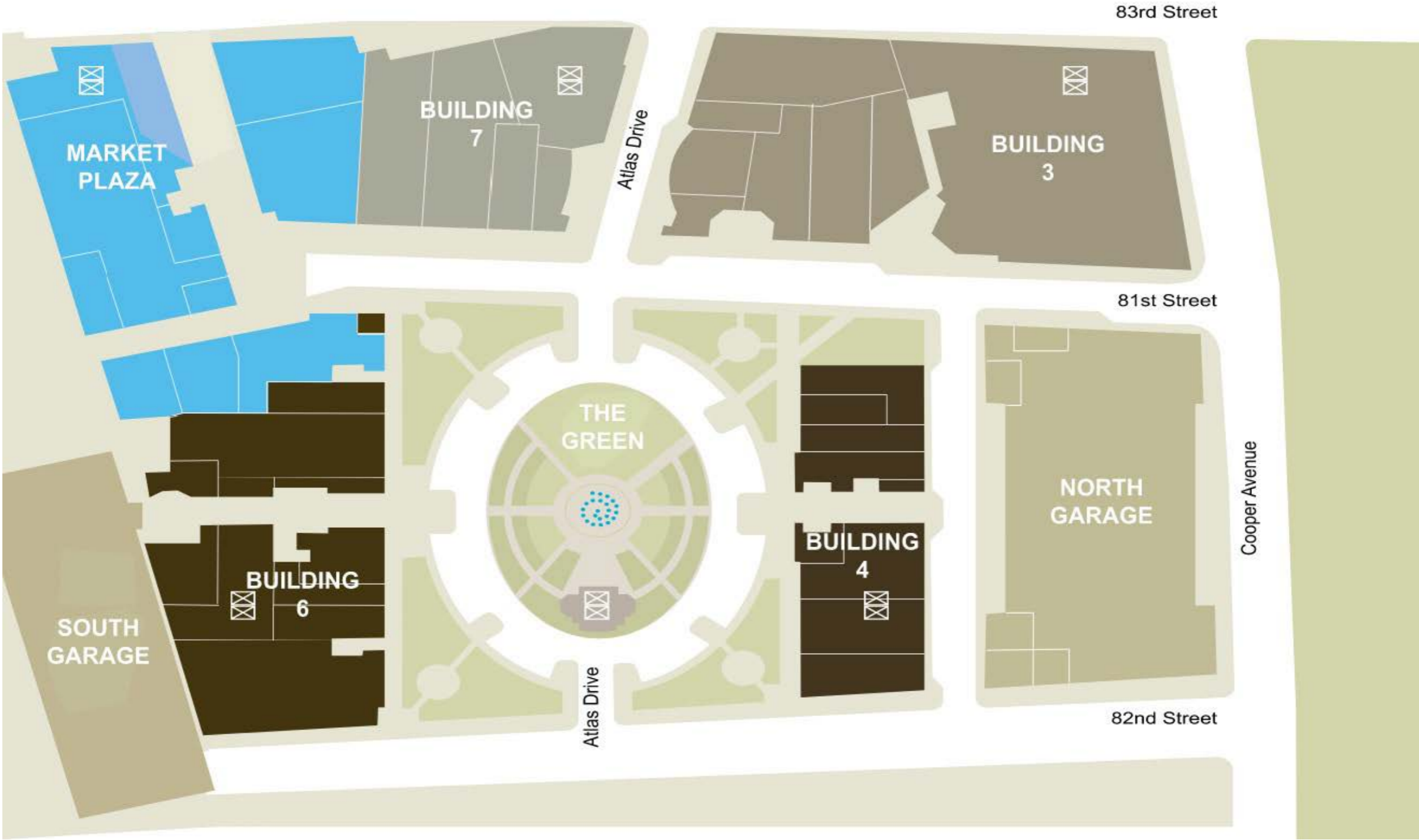



# BUILDING 3 & 7 CRITERIA

## DESIGN PHILOSOPHY

Atlas Park and the buildings surrounding it are intended to invoke an urban European ambiance. The white GFRC facades evoke familiar, historical forms without directly referring to any single piece of architecture. This choice highlights the merchandise mix, and will attract shoppers, diners and business people from the surrounding area and beyond to the benefit of all tenants. The buildings are simplified, modern interpretations that are designed to be clean backdrops for elegant Tenant merchandising, signage and graphics. A high level of quality will be consistently maintained. Notwithstanding the desire to enable Tenants to express their identity, the buildings are composed of several large architectural gestures and of uniform colored materials in order to unify the 2.5 acre park. Tenants are allowed more freedom in the Buildings 3 and 7 facade than in the wood-Storefront zone of Buildings 4 and 6.



BLDG 7 EAST

### NEUTRAL PIER DETAIL

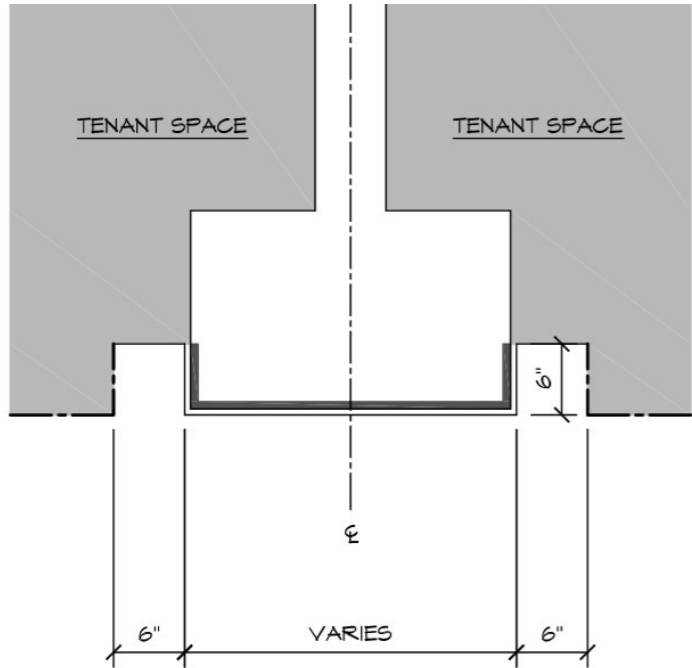

### STOREFRONTS

The Tenant will have the opportunity to enhance their identity by introducing their own finishes/material within the Storefront zone. Required storefront height is 15'-0".

### AWNINGS AND SHADE ELEMENTS

Awnings are permitted on the North elevation of Building 7 and the South elevation of Building 3. Awnings may also provide a physical extension of the perceived space. Awnings must fit within a Storefront opening and should otherwise comply with the Awning section of this manual.

# BUILDING 3 & 7 VIEWS



# BUILDING 4 & 6 CRITERIA

## DESIGN PHILOSOPHY

Atlas Park and the buildings within it are intended to invoke an urban European ambiance. The white GFRC facades evoke familiar, historical forms without directly referring to any single piece of architecture. This choice highlights the merchandise mix, and will attract shoppers, diners and business people from the surrounding area and beyond to the benefit of all tenants. The buildings are simplified, modern interpretations that are designed to be clean backdrops for elegant tenant merchandising, signage and graphics. A high level of quality will be consistently maintained. Notwithstanding the desire to enable tenants to express their identity, the buildings are composed of several large architectural gestures and of uniform colored materials in order to unify the 2.5 acre park. The wood storefronts are integral to the building architecture, requiring tighter design control.



## NEUTRAL PIER DETAIL

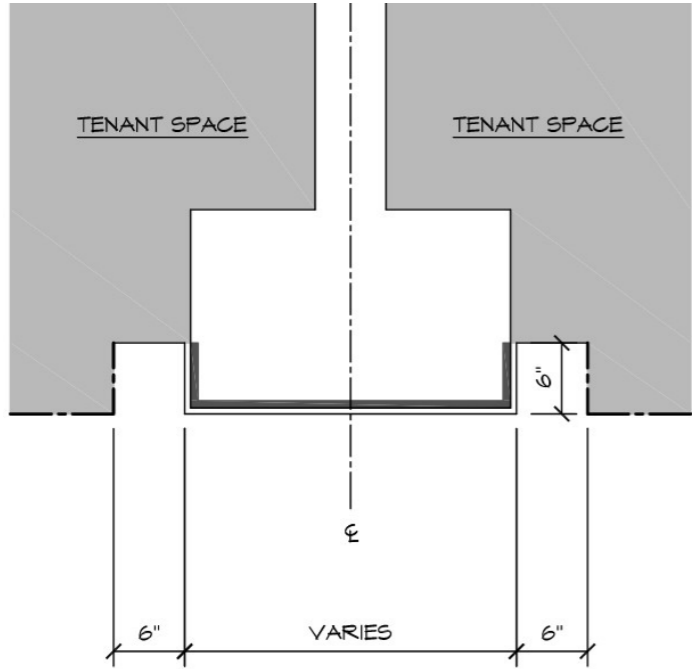

## STOREFRONTS

The storefronts have been designed to provide maximum transparency while emulating traditional European shopping streets. The Tenant will have the opportunity to introduce their own finishes/materials within the storefront zone.

## AWNINGS AND SHADE ELEMENTS

The terrace on Level 02 of Building 6 is an exterior egress corridor, and is, therefore, subject to special requirements to comply with NYC Code. A fire restraint continuous cover projecting at least 4'-7" from the building is required. Tenant is required to provide awnings/hard canopies. Tenants must utilize Landlord's awning contractor to ensure that the coverage is appropriate.

The shapes and materials available to create storefront awnings and canopies are diverse and should be handled in a creative way. The shapes, patterns and materials of these elements will be closely monitored to assure that the project character is respected, and that all awning dimensions are contained within the allowable projection zone.

The lowest point of any awning shall not be less than 8'-0" above the finished grade. It is the Tenant's responsibility to ensure that awnings conform to all applicable codes. Awnings shall not be enclosed on the underside. Internally illuminated awnings are not permitted.

Awnings soil quickly in any environment, and therefore, it is the Tenant's responsibility to maintain appearance of the Store's awnings to the satisfaction of the Landlord.

# BUILDING 4 & 6 VIEWS



# MARKET PLAZA BUILDING CRITERIA

## DESIGN PHILOSOPHY

The facades of these three buildings form a space merchandised as a lively marketplace named Market Plaza. The mood is that of a small town or neighborhood as opposed to the more formal town square “European ambiance” of the buildings that encompass Ellipse Park. The design is permissive, having a degree of non-design happenstance with “uncontrolled signage” and “graphic disharmony”. The paving is simple concrete with movable planters leading into Ellipse Park.

The buildings facing into Market Plaza have their own personality that lends a unique and distinct character to this area. This is a pedestrian area where outside dining by approval is encouraged to create a lively marketplace atmosphere. There is a provision for a rain tent between buildings 7 and 8.

Building 8 is an existing three-story brick and timber frame structure. The Offices at Market Plaza are accessed through this building. The south elevation of Building 7 is brick with Storefront penetrations and features folding Storefront doors that enable the Storefront to be opened. The finished floor is five feet below the entry threshold. The west elevation of Building 6 is similar in character to the south elevation of building 7.



## STOREFRONTS

The shopper must first be stopped by the intrigue of the display in the window and then be drawn into the store by an inviting entry. The entire storefront design revolves around these elements and the creative orchestration of these events. The entry should be prominent and inviting and should make a statement about the mood and style of the store. In the same way, display windows are more than a frame; they can interact with the merchandise and interior design of the Store as well as the shopper.

## FACADE TRANSPARENCY

Tenants shall maximize the use of the storefront glass to maintain a show-window type concept.

## ENTRIES AND DOORS

Entry doors are supplied by Landlord and are a pair of doors with a 6'-0" opening for each distinct elevation which is twenty feet (20'-0") or greater in width. Changes to door systems are subject to approval and must fit into the established Storefront dimensions and details.

## AWNINGS

Building 8: Metal and glass canopies are encouraged. Canopies must be below the Landlord rain tent.

# MARKET PLAZA BUILDING VIEWS



# DESIGN INSPIRATION CONTENT OVERVIEW

5.1

## VISUAL CONCEPTS

GUIDE TO DIFFERENT AESTHETIC CONCEPTS ENCOURAGING VIBRANT STORE DESIGNS.

5.2

## KEY DESIGN ELEMENTS

OVERVIEW OF THE CORE DESIGN ELEMENTS TO EMBRACE WHEN CREATING AN ENLIVENING RETAIL EXPERIENCE.

The vibrant character of great shopping destinations is comprised of exceptional storefronts with texture, color, lighting, graphics and merchandising enlivening the pedestrian experience.

Tenants are encouraged to express their individuality and their brand identity through excellent design by forward thinking design teams.



# VISUAL CONCEPTS > OVERVIEW

- ARTISAN
- URBAN
- WHIMSICAL
- INVITING
- ARTSY
- THEATRICAL

This section highlights six design concepts encouraged by Macerich for Tenants looking for additional inspiration. Our Design team welcomes Tenants to engage in these concepts and invites open collaboration in an effort to create store designs that enhance the retail experience.

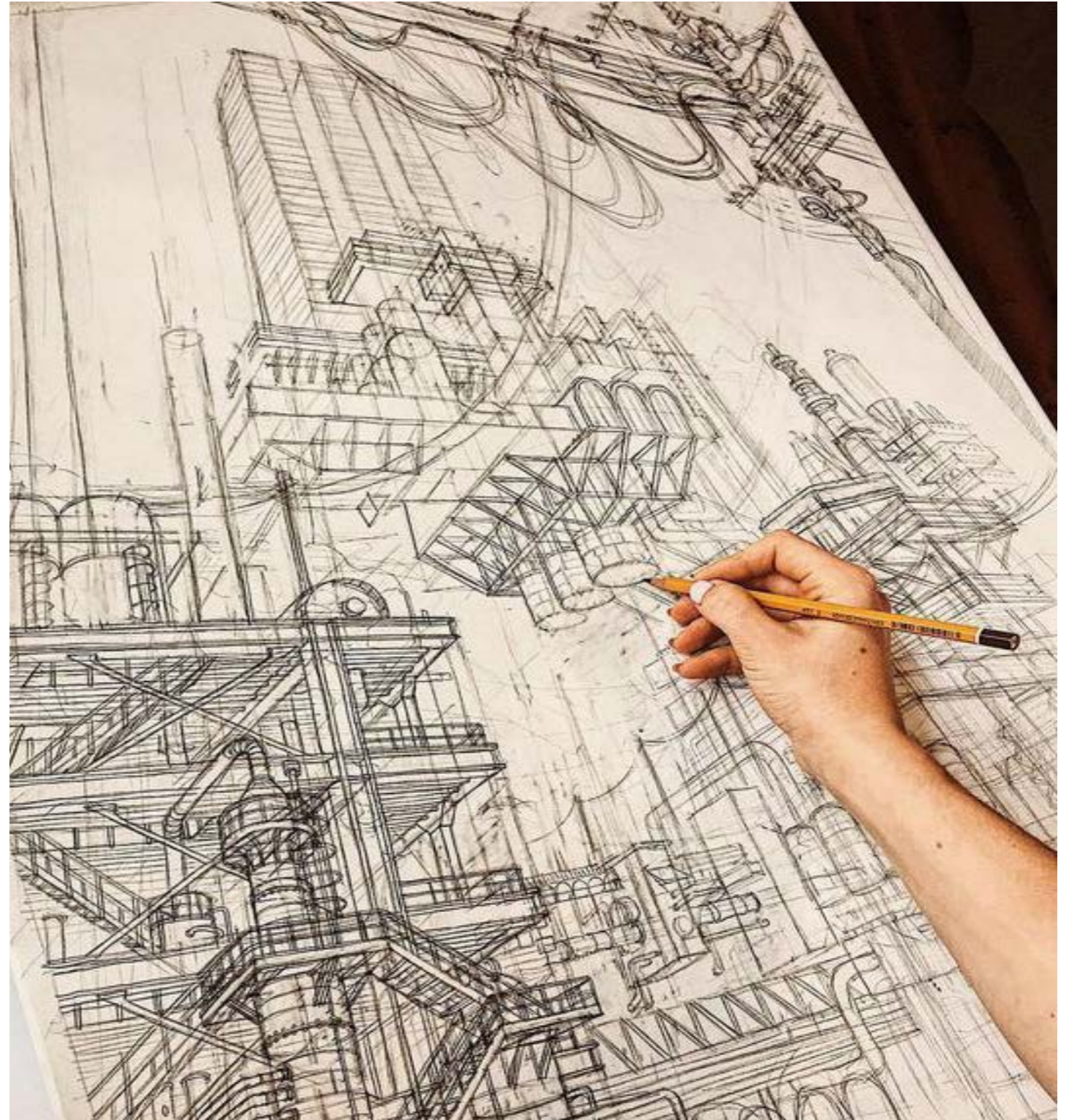



VISUAL CONCEPTS > ARTISAN

# ARTISAN

NATURAL, SOPHISTICATED, UNIQUE



> URBAN

# URBAN

EDGY, FUNKY, STREET SAVVY STYLE, INDUSTRIAL

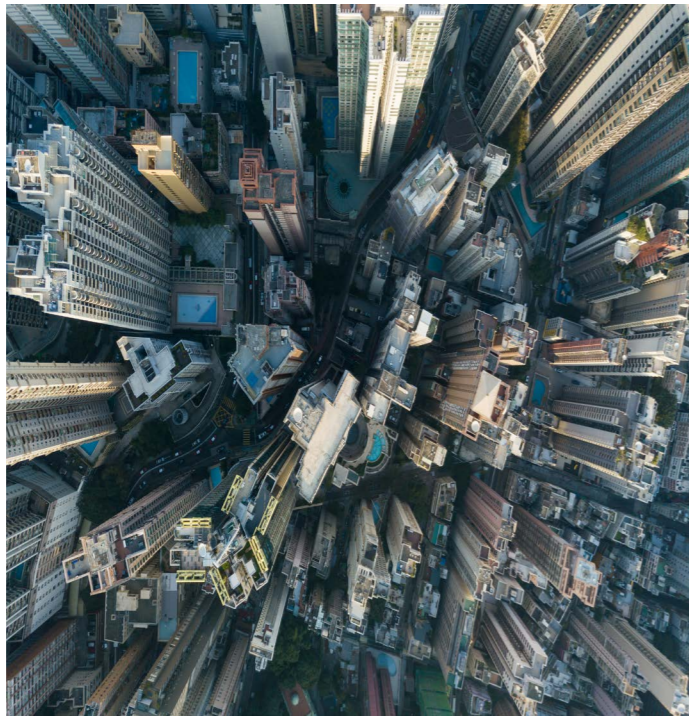

> WHIMSICAL

# WHIMSICAL

UNEXPECTED, PLAYFUL, COLORFUL



> INVITING

INVITING  
WARM, CALM, OPEN, SOFT



> ARTSY

# ARTSY

QUIRKY, AVANT GARDE, SURPRISING



## > THEATRICAL

**T H E A T R I C A L**  
**DRAMATIC, HIGH CONTRAST, MOVEMENT**



# KEY DESIGN ELEMENTS > BRANDING / VISUAL MERCHANDISING

**Macerich embraces four key design elements to engage Customers and encourage Store traffic and sales. Strong use of textures, colors, lighting, graphics, and merchandising in these elements help draw Customers and invliven the pedestrian experience.**

## BRANDING

A brand is a name, term, design, symbol, color or some other feature that identifies a seller's product or services as distinct from those of other seller's.

Your branding can be communicated with signage, graphics, materials, shapes, colors, textures, patterns and the overall look and feel of your kiosk, to tell a story and create a lasting experience.



## VISUAL MERCHANDISING

Strong visual presentation and merchandising are essential and integral components of retail design.

- Attempt to create triangular composition within style groups or color groups. (display in groups of three or five).
- Start with a center feature, (best sellers and hot items), and merchandise out symmetrically or asymmetrically in a balanced manner.



## > LAYERING / TECH AND MEDIA

### LAYERING

How can you make a wall / elevation into a canvas for communication to the Customer as they walk towards or by your store?

- Incorporating patterns and textures.
- Overlaying materials to create dimensionality.
- Molding shapes to create softness.
- Overlapping to create shadows and depth.



### TECHNOLOGY AND MEDIA

Technology can enhance your online operation by transforming your retail space into a multifunctional one, that lends itself to being an in-store pick up location, payment booth or advertising billboard.

Integrating technology into your Store design can:

- Become an extension of you.
- Supplement your salesforce with interactive screens for ordering, self-design functions and more.
- Keep your business connected with your customer.
- Help you tell a story.
- Help make menu boards easier to update and better communicate your offerings to your Customer via LCD screen loops.

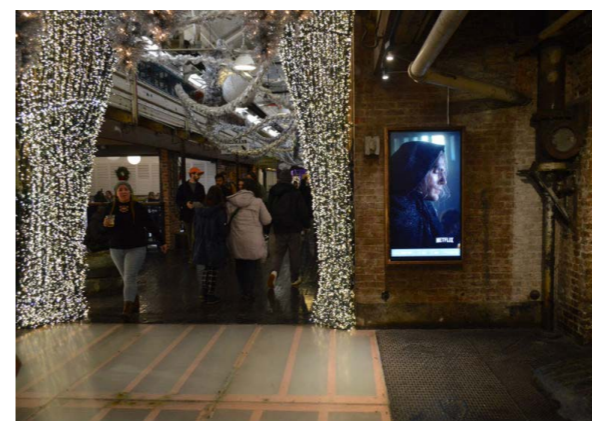



# PROPERTY INFO CONTENT OVERVIEW

6.1

## ADDRESS & HOURS

LOCATION AND SCHEDULE INFORMATION.

6.2

## SITE PLAN

OVERVIEW MAP OF CENTER.

6.3

## CONTACTS

MALL CONTACTS, REQUIRED CONTRACTORS, LOCAL MUNICIPALITIES, AND UTILITY CONTACT INFO.

6.4

## CODES AND PERMITTING

OVERVIEW OF BUILDING CODE, CLASSIFICATIONS, AND LOCAL PERMITTING.

6.5

## OPERATIONS AND UTILITIES

OVERVIEW OF CENTER OPERATIONS AND TYPICALLY AVAILABLE UTILITIES.

6.6

## CONSTRUCTION

OVERVIEW OF CONSTRUCTION PROCEDURES.

The Property Info Criteria provides an overview of the Center's building classification, contacts, local permitting, and typically provided utilities.

It is important to note that the Contacts section includes the Center's required contractors. These contractors **must** be used during the design and buildout of your Store.



# ADDRESS & HOURS

The Shops at Atlas Park is located immediately to the the wouthwest of Forest Hills, New York, at the intersection of Cooper Avenue and 80th Street. The site is within easy access of the neighborhoods of Forest Hills, Elmhurst, Maspeth, Middle Billage, Glendale, Ridgewood, and Woodhaven and is accessible to the Jackie Robinson Parkway and Long Island Expressway.

## Center Address

8000 Cooper Avenue  
Glendale, NY 11385

## Center Hours

Monday - Saturday: 10:00 AM to 9:00 PM  
Sunday: 11:00 AM to 6:00 PM

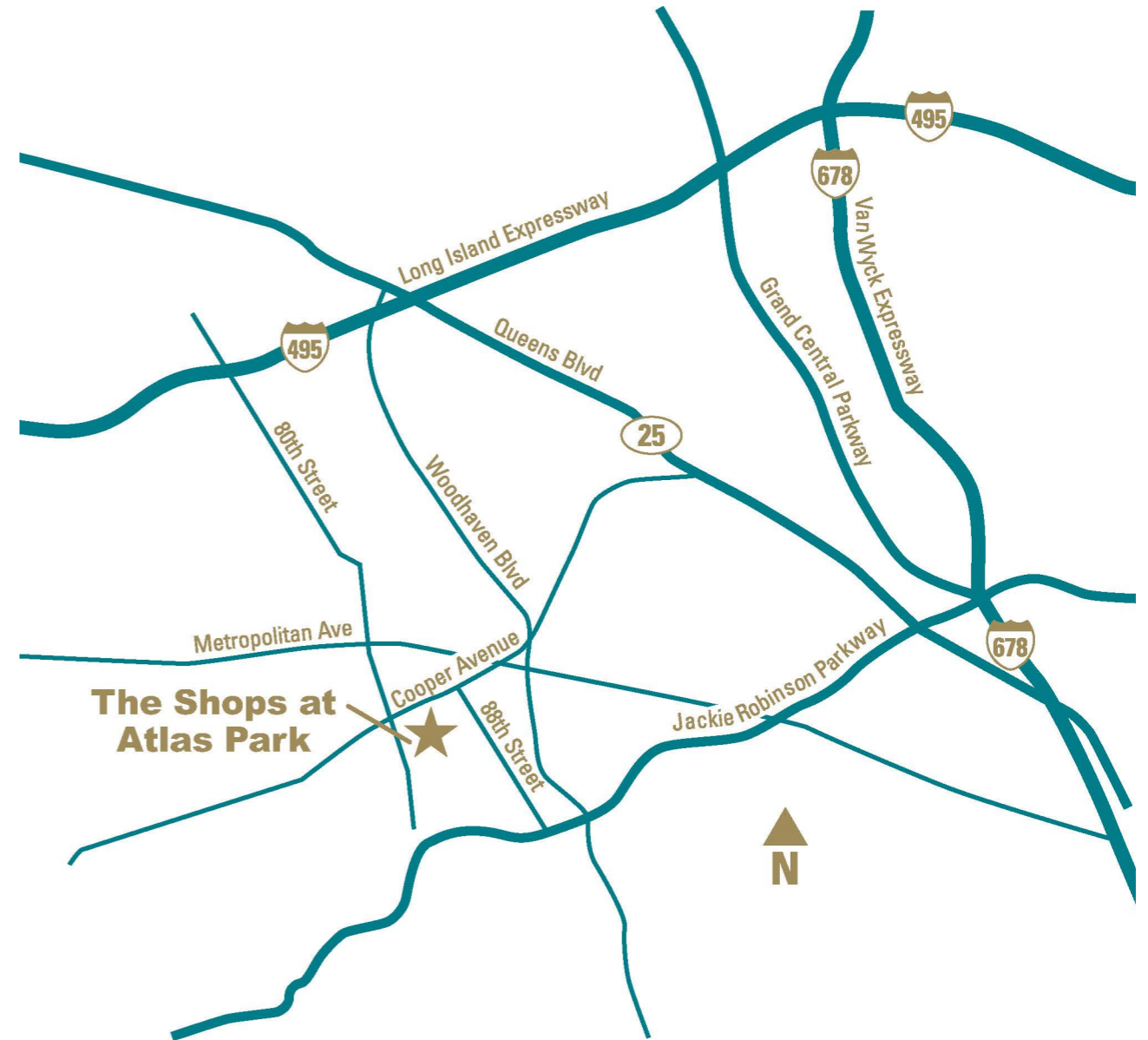

# SITE PLAN

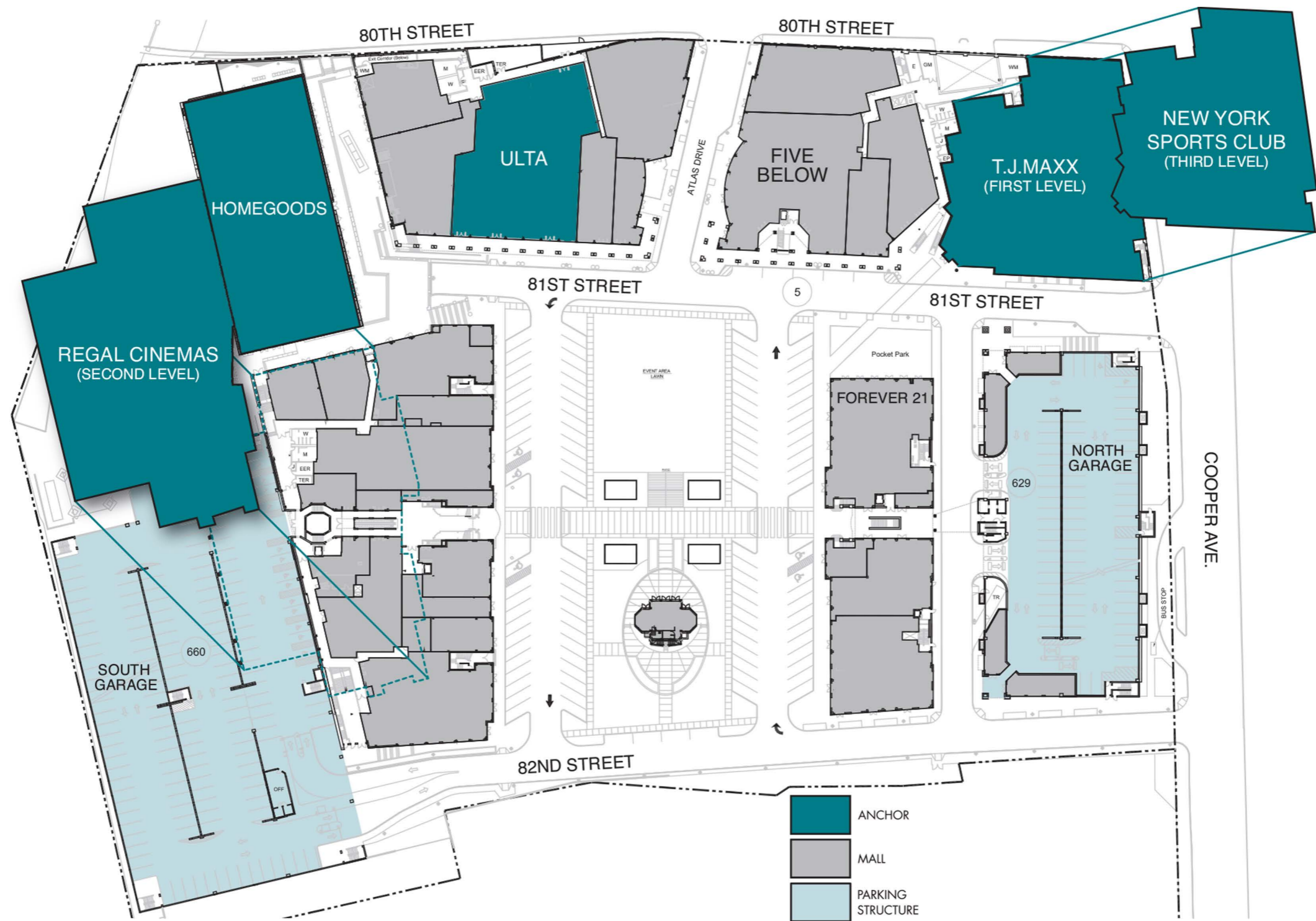

# CONTACTS > PROPERTY TEAM / REQUIRED CONTRACTORS

### PROPERTY TEAM

The following points of contacts are available to discuss site details and procedures. The primary point of contact for inquiries is the Tenant Coordinator.

#### **PROPERTY MANAGER**

Peter DeLucia  
Phone: (718) 326-3300  
[peter.delucia@macerich.com](mailto:peter.delucia@macerich.com)

#### **OPERATIONS MANAGER**

Maurice Spivey  
Phone: (718) 326-3300  
[maurice.spivey@macerich.com](mailto:maurice.spivey@macerich.com)

#### **TENANT COORDINATION**

Amy Christ  
Phone: (585) 249-4413  
[amy.christ@macerich.com](mailto:amy.christ@macerich.com)

#### **LEASING**

Nina Maurello  
Phone: (718) 326-3300 x108  
[nina.maurello@macerich.com](mailto:nina.maurello@macerich.com)

#### **LANDLORD/OWNER**

MACERICH  
401 Wilshire Blvd., Suite 700  
Santa Monica, CA 90401

### REQUIRED CONTRACTORS

The following points of contacts are the required contractors that must perform the construction for their related field and/or systems. These contractors are required since they have intimate knowledge of the property building systems and can properly interface Tenant systems with the base building infrastructure.

#### **SPRINKLER AND FIRE ALARM CONTRACTOR**

Sirina Protection Systems Corp - Darren Naipaul  
151 Herricks Road, Suite 103 Garden City Park, NY 11040  
Phone: (212) 929-6800

#### **ELECTRICAL (FOR FINAL CONNECTIONS)**

Ral-Bar Electric  
34-09 45th St. Long Island City, NY 11101  
Phone: (718) 786-9430

#### **ROOFING CONTRACTOR**

JVS Restoration - Wesley Kulesza  
139 Merrick Road Lynbrook, NY 11563  
Phone: (516) 792-1790  
[WKulesza@jvseusa.com](mailto:WKulesza@jvseusa.com)

#### **DUMPSTER SERVICE**

To be coordinated through mall management.  
Keter Environment  
4 High Ridge Park, Suite 202 Stamford, CT 06905  
Phone: (203) 989-2296

#### **ENERGY MANAGEMENT**

Lite-Trol Service Co, Inc.  
485 W. John Street Kicksville, NY 11801  
Phone: (516) 256-0317  
[mandiel@crs-group.com](mailto:mandiel@crs-group.com)

#### **LANDLORD REQUIRED EXPEDITER**

DOMANI Consulting - Joseph Todisco  
68 Whitehall Street Lynbrook, NY 11563  
Phone: (516) 256-0317  
[jtodisco@domaniconsultinginc.com](mailto:jtodisco@domaniconsultinginc.com)

OR

Green Light Expediting LLC - Manny Russell  
43-24 21st Street Suite 202 Long Island City, NY 11101  
Phone: (718) 514-7562

#### **Barricade**

Boston Barricade  
NY Local Team  
Doug Guerra (GM)  
772-257-7330  
[dguerra@bostonrs.com](mailto:dguerra@bostonrs.com)

# CONTACTS > UTILITIES / LOCAL AGENCIES

### UTILITIES

The following points of contact are required to set up utility accounts:

#### **ELECTRICAL**

*Electric is submetered by Landlord. If Tenant work includes submeter install, work must be performed by Ral-Bar Electric.*

Source One  
7 Penn Plaza New York, NY 10001  
Phone: (212) 612-7606

#### **GAS**

National Grid  
Phone: (718) 643-4050

#### **TELEPHONE**

DVSA Technologies  
Phone: (516) 678-0275

#### **CABLE / INTERNET**

DVSA Technologies  
(516) 678-0275

#### **WATER METER**

The Water Group  
1825-65th Street Suite #200 Brooklyn, NY 11204  
Phone: (718) 621-3331 ext. 13  
Rita@watergroupny.com

### LOCAL AGENCIES

The following points of contacts are the local agencies responsible for plan reviews and inspections:

#### **BUILDING AND SAFETY**

New York City Department of Buildings  
Queens Borough Office  
Phone: (718) 286-0600

#### **HEALTH DEPARTMENT**

New York Department of Health and Mental Hygiene  
Division of Environmental Health  
Bureau of Food Safety and Community Sanitation  
253 Broadway, 6th Floor Box CN-59A  
New York, NY 10007  
Phone: (212) 676-1600

#### **FIRE DEPARTMENT**

Fire Department of New York

#### **LIQUOR LICENSING**

New York State Liquor Authority

### ENGINEERS OF RECORD

The following points of contacts are the engineers of record for the property and should be used for any questions related the engineering of the property.

#### **STRUCTURAL ENGINEER**

Consulting Engineers - Rodney D. Gibble  
1123 Broadway SUite 917 New York, NY 10010  
Phone: (212) 989-2853

#### **MEP ENGINEER**

DLB Associates Consulting Engineers, P.C.  
2403 State Route 66 Ocean, NJ 07712  
Phone: (732) 774-2000

# CODES AND PERMITTING

## **BUILDING CODE OVERVIEW**

The Shops at Atlas Park offers spaces for retail, restaurants, and entertainment. Below are the pertinent property details related to local building codes. It is the sole responsibility of the Tenant's Architect, Engineers, Consultants, and Contractors to comply with all applicable federal, state, and local codes and ordinances for their occupancy type.

## **BUILDING TYPE**

Single level regional shopping center of approx. 371,144 square feet of gross leasable area.

## **CONSTRUCTION CLASSIFICATION**

Building Use Group Mercantile (Group C)

## **APPLICABLE CODES**

Building Code of the City of New York

## **ENVIRONMENTAL CODE**

All tenant intrusive construction work taking place within Building 3, Building 7, and Building 8 (Parcel B) must be conducted in accordance with the New York State Department of Environmental Conservation (NYSDEC)-approved Site Management Plan (SMP). The SMP details institutional and engineering controls required for Parcel B to address residual contamination remaining after remediation under the Brownfield Cleanup Program (BCP). To comply with the SMP, Tenant is responsible for notifying Macerich management and providing required submissions to Macerich and their remedial engineer at least 15 days prior to intrusive construction. The notification procedure and required submissions are described below:

- At least 15 days prior to ground intrusive construction, Tenant must notify Macerich management about the proposed intrusive activities; and Macerich management will notify the remedial engineer.
- Concurrent with the notification, tenant should provide the following documents to Macerich and remedial engineer:
  - Detailed plans indicating the extent of concrete cutting, disruption of materials below slabs/asphalt/clean cover, etc.;
  - OSHA certificates for equipment operators and laborers (if deemed necessary), in accordance with the Health and Safety Plan (HASP) previously prepared for the site;
  - Proposed plan for off-site disposal or on-site reuse of excavated materials;
  - Proposed sources and clean certifications for any imported material for backfill purposes;
  - Procedures for soil stockpiling (i.e., protection of stockpile surfaces, and covering);
  - Procedures for odor, dust, and nuisance control.
- Proceeding with intrusive work without the property notifications and without following the procedures outlined above is in violation of NY State Laws and could result in a revocation of the NYSDEC Certificate of Completion (COC)

## **PERMITTING**

Tenant construction, signage, and food service all require permitting from New York City Department of Buildings. Detailed procedures are in the [PERMIT GUIDELINES](#) linked in the [ADDENDUM](#).

### **I. BUILDING PERMIT**

Requirements can be found here: <https://www1.nyc.gov/site/buildings/property-or-business-owner/obtaining-a-permit.page>

### **II. SIGN PERMIT**

Sign permits are required for all exterior signage. Additional municipality approval required for all signage facing 80th & Cooper Avenue.

## **PLEASE NOTE:**

### **MERCHANDISE AND EMPLOYEE OCCUPANCY:**

Please note that all inspections for trades and Life Safety must have proof of approval from the appropriate municipal governing authority (DOB & FDNY) prior to the arrival of merchandise and employees if a Certificate of Occupancy is NOT required.

# OPERATIONS AND UTILITIES

## OPERATIONS

The following is a brief overview of the site infrastructure available during retail operations and construction.

- I. **PARKING** Contractors may use either the North or South parking garages located on-site.
- II. **DELIVERIES** Deliveries can be made to either truck dock at any time. If the gate is down, call the security # located on the front of the gate to be let in. Deliveries can be made from the ring road inside the property, provided the deliveries are made outside normal business hours.
- III. **TRASH** Coordinate with mall operations during construction. General Contractor to supply labor to bring trash to dumpster. Demo contractor must take trash with them on night demo work, with their own packer trucks. Demo contractors are prohibited from using any dumpster on-site. Tenant to set up trash through Keter Environmental Services.

## SITE UTILITIES AND SERVICES

The following is an overview of the utilities and services typically available for tenant spaces. Please refer to lease language for any agreed upon changes that may overwrite these typical service provisions. It is the Tenant’s responsibility to verify existing conditions and comply with all applicable codes and standards for all Technical systems.

- I. **ELECTRICITY**  
Tenant shell spaces typically provide conduit to a main power source.  
Submeter to be installed by Landlord’s required vendor. Contact mall’s Operations Manager or Tenant Coordinator for more information.
- II. **DATA AND COMMUNICATIONS**  
Tenant is responsible to set up service with the providers listed in the Property Info contacts.
- III. **SPRINKLER SYSTEM**  
Tenants are responsible for contracting with the Landlord’s required sprinkler vendor to adjust any existing grids, or install new if none exist, and tie into the main system.
- IV. **FIRE ALARM SYSTEM**  
Tenants are responsible for contracting with the Landlord’s required fire alarm vendor to install all code-required alarm, horns, strobes, conduit within the Tenant’s space to tie into the Landlord’s main fire alarm panels.
- V. **WATER**  
Tenant shell spaces typically provide domestic cold water stubbed into the space. Size and location of the pipe varies per space. Spaces also typically provide a sanitary riser within 75 ft. of the space. Size and location of the line varied per space.  
Water use is metered and charged by the Landlord for retail Tenants. A separate account with a water utility company is usually not required.
- VI. **HVAC**  
Tenants HVAC systems vary from building to building as detailed in the Inline Technical Criteria.
- VII. **GAS**  
Gas may be available. Tenants are responsible to set up service with the local gas utility.

# CONSTRUCTION > PRE-CONSTRUCTION / CLOSE OUT

## CONSTRUCTION

The following is a brief overview of the construction process and requirements for a tenant build outs:

### CONTRACTOR REQUIREMENTS AND WORKING ENVIRONMENT

Tenant, at Tenants sole cost and expense must ensure the following:

- All tradespersons entering the job site must be current members of a local building trades union and must, at all times, carry on their person such evidence of proof of their membership as may be required by the Landlord.
- All materials transported to and from the site must be done so by members of a current local building trades union.

### PRE-CONSTRUCTION

Prior to any construction commencement, the contractor's site superintendent is required to meet with the Landlord to review property construction requirements, submit construction documentation, and provide payment for property construction fees.

Required pre-construction documents include:

- Landlord Approved Construction Drawings
- Contractors Rules & Regulations to be completed and signed in full
- Approved GC Certificate of Insurance
- A copy of the Building Permit issued by the City
- General Contractor's state license
- Construction Progress Schedule
- Subcontractor List (include associated trade, contact name and phone number)

The Landlord will send a Preparedness Letter detailing the fees required for collection prior to scheduling this pre-construction meeting.

[CONTRACTOR RULES AND REGULATIONS](#) are linked in the [ADDENDUM](#).

### CLOSE OUT

At construction completion, the Landlord will meet with the superintendent to perform a punch list walkthrough. The created punch list is required to be completed to the Landlord's satisfaction in order to close out the construction project. All construction charges must be paid in full. A reference [PUNCH LIST](#) is linked in the [ADDENDUM](#).

To complete closeout, submit the documents detailed in the [CLOSE OUT](#) link in the [ADDENDUM](#).

- ALL PROJECTS FOR NYC : THE LANDLORD MUST BE PROVIDED THE FINAL DOB / FDNY STAMPED DRAWINGS FOR ALL DISCIPLINES INCLUDING:
  - ARCHITECTURAL
  - STRUCTURAL
  - MECHANICAL
  - PLUMBING
  - SPRINKLER
  - FIRE ALARM
  - ELECTRICAL
  - VERTICAL TRANSPORTATION
- ADDITIONALLY, IT IS THE TENANT'S RESONSIBILITY TO PROVIDE COPIES OF ALL ANNUAL VERTICAL TRANSPORTATION INSPECTIONS UPON REQUEST BY THE LANDLORD.



# SUBMITTAL CRITERIA CONTENT OVERVIEW

7.1

## CONSTRUCTION DRAWINGS

SUBMITTAL REQUIREMENTS FOR ARCHITECTURAL AND TECHNICAL DESIGN DOCUMENTS.

7.2

## SIGNAGE DRAWINGS

SUBMITTAL REQUIREMENTS FOR PRIMARY AND SECONDARY STOREFRONT SIGN DESIGNS.

7.3

## KIOSK DRAWINGS

SUBMITTAL REQUIREMENTS FOR ARCHITECTURAL AND TECHNICAL KIOSK DESIGN DOCUMENTS.

**The Submittals Criteria highlights the Landlord review process and drawing submittal requirements to ensure a quick and smooth drawing review for your design and construction drawings.**

Tenant construction and signage drawings must be reviewed and Approved by the Landlord before the drawings can be submitted for permit. Permits from the local Municipality are required for all incoming Tenant construction and signage.

It is always the Tenant's responsibility to ensure:

- Compliance with the Lease document.
- Field verification of conditions and dimensions.
- Discrepancies between the drawings and the as-build conditions.
- Coordination with trades to ensure compliance with all local and national codes.

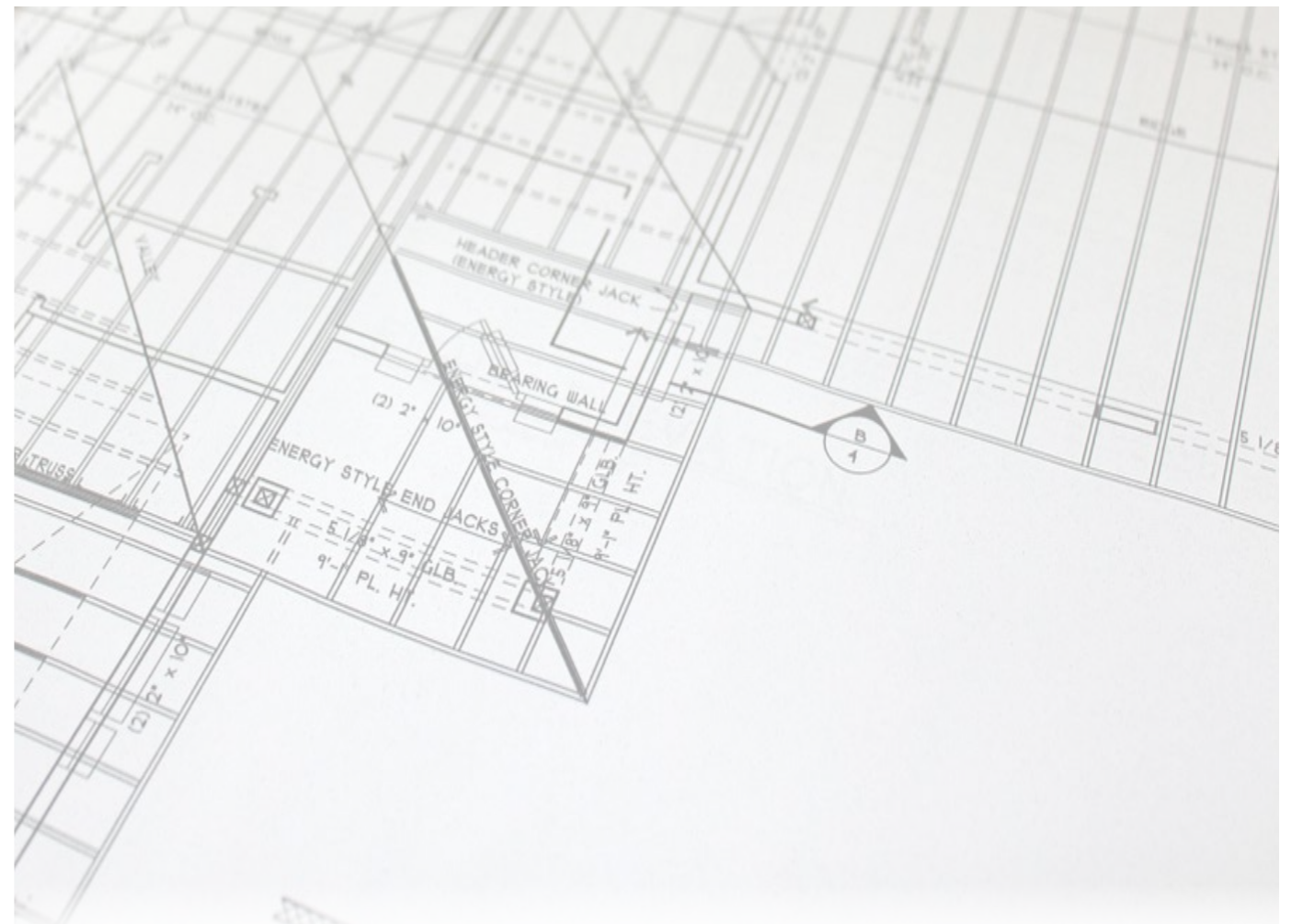

# CONSTRUCTION DRAWINGS > PROCESS & TIMELINE

## DRAWING REVIEW PROCESS

Drawing reviews are required to be submitted in two stages for Landlord review; Preliminary and final Construction Drawings. Preliminary drawings are required to ensure the design process moves quickly by ensuring that all Criteria requirements are understood and adopted early in the design. This helps ensure an expedited review of the final Construction Drawings.

## REVIEW TIMELINE

Step	Action	Time Period
1	Tenant submits preliminary design.	Required 20 days after Lease Execution or 10 days following previous submittal disapproval.
2	Landlord Approved Preliminary Design.	15 days after confirmed completion of Step #1.
3	Tenant submits final construction drawings.	Required 20 days after Tenant Coordinator approval at Step #2.
4	Landlord Approves final documents.	15 days after completion of Step #3.
5	Tenant submits drawings for permit. (If applicable)	5 days after confirmed completion of Step #4.
6	Tenant responds to any requests from or comments by permitting jurisdiction.	5 days.
7	Upon permit review approval, Tenant pays all fees and logs out permit.	5 days.

## > SUBMITTAL REQUIREMENTS > PRELIMINARY

### PRELIMINARY DESIGN SUBMITTAL

The Preliminary Document review process will evaluate all the criteria discussed in this manual, including overall three-dimensional form, degree of design uniqueness and identity, use and detailing of materials, colors and lighting, and integration of signage and graphics.

Submittals are to provide the reviewer with a clear understanding of proposed design concepts.

The submission must be complete in order to fairly evaluate the proposal and prevent continuation of work on an unacceptable design.

Tenant shall submit to Landlord an electronic PDF files of the following:

- **Color and Material Sample Board**  
Include actual samples of all Tenant colors and materials visible to the public, on a digital sample board. Clearly label all materials and reference to floor plan elevations.
- **Perspective and/or Photo Image(s)**  
Colored perspective rendering and/or prototypical photo images of the proposed storefront, including graphics and signage.
- **Cover Sheet**  
Include: Name of Tenant, name of Mall or Center, space number, Applicable Codes, Building Type and Occupancy Type, Leased square footage, and Key Plan
- **Floor Plan**  
¼" Scale Minimum showing: Entire lease dimensioned space with room names, floor finishes, casework and fixture locations.
- **Reflected Ceiling Plan**  
¼" Scale Minimum showing: Lighting design, including fixture types and locations, signage, access panels, Overhead projections such as light coves and fascia systems, and Entrance.
- **Sections**  
1" Scale Minimum showing: Entry, Display windows and fascia, Sign integration into storefront design.
- **Storefront Elevations**  
½ Scale Minimum showing: Exterior views - front and sides, Signs, graphics, logos.

**Copies of all drawings are to be sent to the Tenant Coordinator via email.**

A physical sample board is also required, mounted on foam core or card stock to be sent in coordination with your Tenant Coordinator.

## > SUBMITTAL REQUIREMENTS > FINAL

### FINAL DRAWING SUBMITTAL

After Preliminary Drawing Approval, it is critical to quickly complete and submit Final Construction Drawings for Landlord review.

If any questions arise from the Tenant's interpretation of the design and criteria information, the Tenant shall assume all responsibility for clarification by written request to the Tenant Coordinator. The Landlord plan review and approval process is independent of local permitting for construction. The Tenant is responsible for procurement and compliance with local, state and federal codes and requirements.

Tenant shall submit to Landlord an electronic PDF files of the following:

- **Responsibility Schedule**  
Any work, which is the Landlord's responsibility, must be listed clearly on a responsibility schedule on the cover sheet.
- **Cover sheet**  
Include a Key Plan, Name of Tenant, name of Mall or Center, space number and location leased premises within Mall or Center, Applicable codes, building type and occupancy type, Leased square footage, Responsibility schedule, and Drawing index.
- **Floor Plans**  
¼" Scale Minimum showing: Entire lease space with room names, Floor finishes, casework and fixture locations, and Demolition plan.
- **Reflected Ceiling Plan**  
¼" Scale Minimum showing: Complete lighting design, including fixture types and locations, signage, access panels, Overhead projections such as light coves and fascia system, Entry, Connection to Landlord's work, Tenant's framing and/or additional structure showing freestanding from Landlord's structure.
- **Sections**  
1" Scale Minimum showing: Entry, Display windows and fascia, Sign integration into storefront design, Connection to Landlord's work, Tenant's framing and/or additional structure showing freestanding from Landlord's structure.
- **Interior Elevations**  
¼" Scale Minimum showing: All sales floor interior views, Built-in casework, signage, and display systems.
- **Storefront Elevations**  
½" Scale Minimum showing: Exterior views - front and sides, Signs, graphics, logos, Landlord neutral piers, Storefront finishes (to be referenced to finish schedule)
- **Architectural Details**  
½" Scale Minimum.
- **Door Schedule**  
Include floor transition details and anti-theft security system details.
- **Details, Catalogue Cut Sheets, and Fixture Finishes**
- **Finish & Color Schedule**

*Copies of all drawings are to be sent to the Tenant Coordinator via email.*

# > SUBMITTAL REQUIREMENTS > FINAL ENGINEERING

## **FINAL DRAWING SUBMITTAL - ENGINEERING DRAWINGS**

The Landlord does not review for mechanical, electrical, plumbing, or structural design, nor does the Landlord accept responsibility for the Tenant's adherence to governing codes.

Tenant shall submit to Landlord an electronic PDF files of the following engineering drawings included in the final drawing set:

### **I. MECHANICAL DESIGN DOCUMENTS**

- Make, type, and performance of all equipment.
- Sign and seal by a Licensed Engineer in the state where the Shopping Center is located.
- Calculations showing the heating and cooling required, including transmission and ventilation losses in the space, and heat and cooling provided for the ventilation supply, and exhaust required for the space. Calculations must be performed in accordance with the latest ASHRAE standards and tabulated in a concise, orderly manner.
- Temperature control system data showing make, control, and energy management systems.
- Exhaust system layout including CFM and equipment specifications.
- Reflected ceiling plan showing HVAC equipment.
- Roof plan with equipment locations.
- Structural details for support of all rooftop equipment and equipment suspended from the steel structure.

### **II. PLUMBING DESIGN DOCUMENTS**

- Make, type, and performance of all equipment.
- Sign and seal by a Licensed Engineer in the state where the Shopping Center is located.
- Complete plumbing system design and floor plan for the Tenant space including, but not limited to the toilets, sinks, urinals, drains, hot water heaters, water coolers, grease trap/interceptors and connections into existing water and sewer lines.
- Single line diagram.
- Fixture schedule.
- Water heater detail as applicable.
- Grease trap cut sheets as applicable.

### **III. FIRE PROTECTION / SMOKE EVACUATION DESIGN DOCUMENTS**

- Reflected ceiling plan, with revised sprinkler head locations.
- Design must be City approved before construction

### **IV. ELECTRIC DESIGN DOCUMENTS**

- Sign and seal by a Licensed Engineer in the state where the Shopping Center is located.
- Panel schedules, load calculations, and meter information, if applicable.
- Structural drawings for all equipment that will be suspended from the steel structure.
- Electrical load summary and Title 24 Energy Calculations (for State of California).
- Floor plan depicting equipment locations and branch circuitry.
- Reflected ceiling plan depicting the layout of light fixtures.
- System one line diagrams.
- Lighting fixture schedule.
- Equipment legend.

### **V. STRUCTURAL DESIGN DOCUMENTS**

- Design elements affecting the structure of the base building.
- Alterations, additions, modifications and reinforcements to the base building which shall be required to accommodate Tenant's Work.
- All calculations & details (Include ICBO numbers on all framing details, Seismic bracing details for State of California.)
- All forms required by governmental agencies and Governmental Regulations, fully and properly completed and executed by Tenant.
- Partial structural framing plan showing existing conditions for new and existing rooftop installations and proposed reinforcement, which shall be accompanied by structural engineers' calculations, drawn on a scale of 1/2"=1'0".
- Ceiling, soffits, storefront attachment details to existing base building.
- A letter from a state-registered structural engineer certifying that all new equipment and design elements serving the Premises are adequately supported to carry the new load.

# SIGNAGE DRAWINGS > PROCESS & TIMELINE

**DRAWING REVIEW PROCESS**

Sign drawing reviews are required to be submitted in two stages for Landlord review; Preliminary and final Construction Drawings. Preliminary drawings are required to ensure the design process moves quickly by ensuring that all Criteria requirements are understood and adopted early in the design. This helps ensure an expedited review of the final Construction Drawings.

**REVIEW TIMELINE**

Step	Action	Time Period
1	Tenant submits preliminary design.	Required 20 days after Lease Execution or 10 days following previous submittal disapproval.
2	Landlord Approved Preliminary Design.	15 days after confirmed completion of Step #1.
3	Tenant submits final sign drawings.	Required 20 days after Tenant Coordinator approval at Step #2.
4	Landlord Approves final documents.	15 days after completion of Step #3.
5	Tenant submits drawings for permit. (If applicable)	5 days after confirmed completion of Step #4.

## > SUBMITTAL REQUIREMENTS > PRELIMINARY, FINAL

### PRELIMINARY DESIGN SUBMITTAL

The Preliminary Document review is intended to acquaint the Landlord with the Tenant's signage design intent.

Submittals are to provide the reviewer with a clear understanding of proposed design concepts.

The submission must be complete in order to fairly evaluate the proposal and prevent continuation of work on an unacceptable design.

Tenant's licensed sign contractor shall submit to the Center's Tenant Coordinator electronic PDF files of the following:

- **Perspective and/or Photo Image(s)**  
Colored perspective rendering and/or prototypical photo images of the proposed storefront, including graphics and signage.
- **Storefront Elevations**  
½ Scale Minimum showing: Exterior views - front and sides, Signs, graphics, and logos highlighting sign dimensions and materials.

### FINAL DRAWING SUBMITTAL

After Preliminary Drawing Approval, it is critical to quickly complete and submit Final Construction Drawings for Landlord review.

If any questions arise from the Tenant's interpretation of the design and criteria information, the Tenant shall assume all responsibility for clarification by written request to the Tenant Coordinator. The Landlord plan review and approval process is independent of local permitting for construction. The Tenant is responsible for procurement and compliance with local, state and federal codes and requirements.

The Landlord does not accept responsibility for the Tenant's adherence to governing codes or verification of job site conditions.

Tenant's licensed sign contractor shall submit to the Center's Tenant Coordinator electronic PDF files of the following:

- Elevation of the storefront including signage and graphics; showing all doors, architectural features, etc., and fully detailed/dimensioned sections and details through the storefront.
- These fully detailed and dimensioned drawings shall be drawn to scale as noted:
  - Storefront Plan, Elevation and Sectional views at 1/2 inch scale.
  - Details of the Signage at 1/2 inch scale or larger.
  - Storefront Signage at 1/2 inch scale.
- Letter style and typeface specifics.
- Color and finish qualities of all portions of signage.
- Material specifications and thickness.
- Transformer specifications, including input and output voltage of transformers. PK housing, (or other UL approved insulating sleeve approved by Landlord and local building codes), is required for all through wall penetrations and must be indicated on the sign shop drawings. Wiring specifications.
- Locations of service switches, access panels and transformers. NONE of these items shall be visible to the public from any portion of the Mall.
- Neon tube specifications, including color and dimension (in mm) of tubes to be used.
- Type of lamps.
- Mounting hardware.

# KIOSK DRAWINGS > PROCESS & TIMELINE

## DRAWING REVIEW PROCESS

Kiosk drawing reviews are required to be submitted in two stages for Landlord review; Preliminary and final Construction Drawings. Preliminary drawings are required to ensure the design process moves quickly by ensuring that all Criteria requirements are understood and adopted early in the design. This helps ensure an expedited review of the final Construction Drawings.

## REVIEW TIMELINE

Step	Action	Time Period
1	Tenant submits preliminary design.	Required 20 days after Lease Execution or 10 days following previous submittal disapproval.
2	Landlord Approved Preliminary Design.	15 days after confirmed completion of Step #1.
3	Tenant submits final construction drawings.	Required 20 days after Tenant Coordinator approval at Step #2.
4	Landlord Approves final documents.	15 days after completion of Step #3.
5	Tenant submits drawings for permit.	5 days after confirmed completion of Step #4.



## > SUBMITTAL REQUIREMENTS > PRELIMINARY, FINAL

### **PRELIMINARY DESIGN SUBMITTAL**

The Preliminary Document review is intended to acquaint the Landlord with the Tenant's signage design intent.

Submittals are to provide the reviewer with a clear understanding of proposed design concepts.

The submission must be complete in order to fairly evaluate the proposal and prevent continuation of work on an unacceptable design.

Tenant's licensed architect shall submit to Landlord an electronic PDF files sized 24" x 36" format of the following on:

- Colored perspective rendering and/or prototypical photo images of the proposed kiosk, including graphics and signage.
- A material sample board, (8-1/2" x 11" minimum), clearly noting the Tenant name and Mall name.
- A floor plan.
- Sections and elevations of the kiosk.

### **FINAL DRAWING SUBMITTAL**

After Preliminary Drawing Approval, it is critical to quickly complete and submit Final Construction Drawings for Landlord review.

If any questions arise from the Tenant's interpretation of the design and criteria information, the Tenant shall assume all responsibility for clarification by written request to the Tenant Coordinator. The Landlord plan review and approval process is independent of local permitting for construction. The Tenant is responsible for procurement and compliance with local, state and federal codes and requirements.

The Landlord does not accept responsibility for the Tenant's adherence to governing codes or verification of job site conditions.

Tenant's licensed architect shall submit to Landlord an electronic PDF files sized 24" x 36" format of the following on:

- A cover sheet including a vicinity map, location map, (LOD), all code compliance notes as required by the city.
- Floor plan detailed and scaled, showing all components, counters, cash wraps, islands, condiment area layout, partitions etc.
- All finishes and fixtures with complete schedules and keyed plans and elevations.
- Details and sections of each side as well as the pylon, counter edge, millwork, toe kick, raised flooring, wall caps, special conditions etc.
- All interior and exterior elevations, with sign locations and dimensions.
- Anything necessary to describe structures or design features, not depicted or easily understood.
- Electrical drawings including a plan layout.
- Plumbing drawings, if applicable.
- Equipment schedule and finish schedule.
- Sign shop drawings, with plan, elevations, sections, materials and details.

# ADDENDUM LINKS

This Addendum contains links to supplemental documents of specific requirements and information. These documents are considered part of the Tenant Criteria Package. Clicking the links below will navigate to the described documents. It is the responsibility of the Tenant, its contractors, subcontractors, architects, engineers, employees, and agents to comply with terms of the Tenant Criteria, Addendum included.

## GLOSSARY

### I. [GLOSSARY OF TERMS](#)

Defines commonly used terms for clarity.

## DESIGN ADDENDUM

### I. [MACERICH SUSTAINABILITY HANDBOOK](#)

Guide to encourage energy efficient, sustainable design.

### II. [SPECIALTY LEASING CRITERIA](#)

Design requirements for temporary Tenant's buildout and signage.

## BARRICADE ADDENDUM

### I. [BARRICADE GUIDELINES](#)

Guide to installing and activating construction barricades with graphics.

## CONSTRUCTION ADDENDUM

### I. [CONTRACTOR RULES AND REGULATIONS](#)

Document detailing the rules and regulations Tenant contractors must adhere to during their construction. This document must be reviewed and signed by the Site Superintendent overseeing the Tenant build out.

### II. [CLOSE OUT REQUIREMENTS AND SAMPLES](#)

Required paperwork and sampled for construction close out procedures.

### III. [HOT WORK PERMIT](#)

Required form to submit when construction required hot work.

### IV. [PUNCH LIST](#)

Reference Landlord Punchlist that that Landlord will use to inspect and confirm completion of Tenant construction.

### V. [PERMIT APPLICATION PROCESS GUIDE](#)

Guide to submitted construction permit documents.