



ARROWHEAD TOWNE CENTER

TENANT CRITERIA

MACERICH®

VISION STATEMENT

Welcome to Arrowhead Towne Center.

It is our vision and mission at Macerich to distinguish ourselves through superior performance in retail development and continuous improvement of our portfolio, to meet the changing needs of our customers and the retailers we serve. Our commitment is to furnish a well-designed, well-maintained and well-marketed retail environment, capable of maximizing traffic and sales.

We are pleased to become partners with retailers, striving for the same goals. We are ready to facilitate communication and share our expertise with you to complete your store within expected timelines.

These criteria act as a guide for the design of all work by Tenants in conjunction with the provisions of the Tenant's lease with the Landlord. Tenants are encouraged to express their own unique design statement within the parameters of the Design Criteria as outlined in this manual.

National and regional "standard" Storefront concepts are respected to the extent that they meet the Design Criteria. However, Tenants should be aware that some concept modifications might be necessary to comply with the Center's Criteria.

The same is true for proposed designs that are overly similar to a neighboring Tenant's Storefront design. We wish to make the Mall as diverse and interesting as possible and enable each Tenant to make a singular statement with their design.



CRITERIA MAIN CONTENTS

1.0 **INLINE**
CRITERIA FOR ARCHITECTURAL, SIGNAGE, AND TECHNICAL DESIGN FOR INLINE RETAIL LOCATIONS.

2.0 **FOOD**
CRITERIA FOR ARCHITECTURAL, SIGNAGE, AND TECHNICAL DESIGN FOR INLINE FOOD, FOOD COURT/HALL, AND RESTAURANTS.

3.0 **KIOSK**
CRITERIA FOR THE DESIGN AND CONSTRUCTION OF RETAIL AND FOOD KIOSKS.

4.0 **BUILDING DETAILS**
ARCHITECTURAL DETAILS, REQUIREMENTS AND REFERENCE PHOTOS BASED ON STORE LOCATION.

5.0 **DESIGN INSPIRATION**
SUGGESTED DESIGN MOTIFS AND INTRO TO KEY DESIGN ELEMENTS.

6.0 **PROPERTY INFO**
PROPERTY LOCATION, CONTACTS, UTILITIES OVERVIEW, OPERATIONS, AND LOCAL PERMITTING INFO.

7.0 **SUBMITTALS**
REQUIREMENTS TO SUBMIT CONSTRUCTION DRAWINGS, RENDERS, SIGN DRAWINGS, AND MATERIAL BOARDS.

8.0 **ADDENDUM**
SUPPLEMENTAL DESIGN AND CONSTRUCTION REQUIREMENTS AND DETAILS PROVIDED AS LINKS TO EXTERNAL DOCUMENTS.

i **INTERACTIVE NAVIGATION**

This Criteria is an interactive document. You may tap or click the top Navigation Bar or the Side Content Bar to navigate directly to that section.

This page serves as a hub to the various sections included in this Criteria.

The sections in this Criteria break down the key categories of information to understand the design and construction requirements to incorporate a successful retail experience. Refer to the overviews included in the left side bar to learn more about the content included in each section.

It is the responsibility of the Tenant, its contractors, subcontractors, architects, engineers, employees, and agents to comply with terms of the Tenant Criteria, including the supplemental documents included in the Addendum.

The intent of this Criteria manual is to:

- Accelerate the leasing process by providing quick answers to questions about specific requirements.
- Establish the design expectations and technical requirements.
- Establish a coherent design by carefully curating and integrating within the Center.
- Guide the design standards.
- Answer basic questions about the design and construction process.
- Save time by minimizing design reviews.



INLINE RETAIL CONTENT OVERVIEW

1.1

DESIGN

CRITERIA FOR ARCHITECTURAL DESIGN REQUIREMENTS FOR RETAIL STOREFRONTS AND INTERIORS.

1.2

SIGNAGE

CRITERIA FOR PRIMARY AND SECONDARY STOREFRONT AND WINDOW SIGN DESIGNS.

1.3

TECHNICAL

CRITERIA FOR TECHNICAL DESIGN ELEMENTS TO ENSURE YOUR STORE CAN INTERFACE WITH THE PROPERTY'S BASE BUILDING UTILITY SYSTEMS.

SECTIONS OF INTEREST

BUILDING DETAILS

Includes property reference photos and specific Storefront design details.

PROPERTY INFO

Includes information on the Property's building codes, area permitting, and required contractors.

SUBMITTALS

Outlines requirements on how and what to compile for submittals to the Landlord for design reviews.

DESIGN INSPIRATION

Provides visual inspirations for design aesthetics.

The Inline Retail Criteria provides key technical information and design requirements to ensure your store enlivens the consumer experience and interfaces with the Center.

The Tenant and the Tenant's Architect assume the following important obligations:

- Fulfill the intent of the Criteria both in concept and in detail.
- Determine and respond to the actual physical conditions of the Tenant's location.
- Maintain and enhance the high standards of quality established in the construction of the Center.
- Ensure the quality of execution of all design material, finish, and detail concepts in the construction of the Tenant's improvement.
- Provide the required detail at all transitions from Tenant Storefront to neighboring Storefronts, as well as to the base building.



DESIGN CRITERIA

STOREFRONTS

- ENTRY
- POP-OUTS / STOREFRONT HEIGHTS / NEUTRAL PIER / CONSTRUCTION

DESIGN CONTROL AREA

- DESIGN REQUIREMENTS / WINDOW DISPLAY / PROHIBITED DESIGN ELEMENTS

MATERIALS

- GLAZING / DECORATIVE GLASS
- WOOD / STONE / PLASTER
- METAL / LEATHER
- WALLCOVERINGS / SOLID SURFACE
- PAINT / FAUX FINISHES / FABRIC / TILE

INTERIORS

- LIGHTING / FLOORING
- CEILING / WALLS & PARTITIONS
- EGRESS DOORS / RESTROOM

SECTIONS OF INTEREST

- BUILDING DETAILS
Includes property reference photos and specific Storefront design details.
- PROPERTY INFO
Includes information on the Property's building codes, area permitting, and required contractors.
- SUBMITTALS
Outlines requirements on how and what to compile for submittals to the Landlord for design reviews.
- DESIGN INSPIRATION
Provides visual inspirations for design aesthetics.

Tenants are encouraged to express the individuality of their brand through excellent design by forward thinking design teams.

This Design Criteria focuses on strong design details visible from the Center common areas. Focusing on a strong Storefront design enlivens the retail experience and draws customers in to shop. Macerich's Design team is always excited to partner with Retailers in curating a unique and memorable shopping experience. Our team is available to collaborate on your enticing Storefront designs. The [DESIGN INSPIRATION](#) section is also a great launching point to explore design concepts and methods to engage customers.

- All Tenants must engage a reputable Architect.
- Design drawings must all be reviewed and Approved by the Landlord.
- All design elements and finishes must adhere to local and national building code requirements.



> STOREFRONTS

The Center's success is dependent on the creative design contributed by individual Tenants. It is vital that your Storefront design is integrated with the look and feel of the Center's aesthetic.

The **BUILDING DETAILS** section includes specific storefront design requirements based on your store's location. These location based requirements must be incorporated into your Storefront's final design.



> ENTRY

ENTRY

Your Storefront entry is a critical design feature to create an invitation to shop. As such all stores must express the entry as an identifiable part of the storefront. The underside of the entry portal soffit shall be finished to match the storefront.

I. SWING DOOR ENTRY

- Swing doors should be located in a recessed vestibule a minimum of 3' from the Storefront.
- No door swing shall project beyond the maximum allowable lease line.
- Minimum allowable door height is 9'-0".
- All other doors are to be hinged or pivot-type doors. Doors are suggested to be the height of the glazed Storefront.
- Recessed entry flooring shall match the Center's flooring requirements.

II. OPEN STOREFRONT ENTRY

- An open Storefront must also present an entry zone. Macerich will review all open Storefronts for alternate articulation and dimensional elements.
- Tenants choosing to have an open storefront are required to secure the premises after business hours with a coiling, sliding or folding security closure which complies with the following design guidelines:
 - Shall be set back from the lease line a minimum of 4".
 - Shall coil overhead or coil, fold or slide horizontally to retract into pockets or enclosures to conceal from view during business hours.
 - All supports, tracks, guides and operating devices must be concealed flush with adjacent Storefront finishes when closure is in the open position and be integrated into the Storefront overall design expression.
 - Horizontal tracks are not allowed in the floor surface.
 - Exposed locking devices or latches are not allowed. Key switches shall be concealed and mounted within the Tenant Storefront proper.
 - All supports to be provided by Tenant. Suspending closures from existing building structure is not allowed.



> POP-OUTS / HEIGHTS / NEUTRAL PIER / CONSTRUCTION

POP-OUTS

Three dimensional pop outs in both plan and height are required for all Storefronts in all new Tenant areas.

- When storefronts are visible from the upper level, special care must be taken so the top is finished to match the Storefront design.
- Exposed conduits, raceways, access panels or equipment may NOT be visible.
- All surfaces of any visible projections must also be finished to match.
- No dust or falling debris may collect on surfaces visible from upper levels. Tenant is responsible for the upkeep of all surfaces.
- Designs may incorporate sloping tops at no less than a 3 in 12 pitch to create a debris resistant surface.

STOREFRONT HEIGHTS

All Storefronts must extend up to a maximum heights per the specific location of your store:

LEVEL 1

LEVEL 2

NEUTRAL PIER

Tenant storefronts are separate by a 6" neutral pier, with 4" recessions on either side. Please refer to Page 109 of this Manual for specific details.

STOREFRONT CONSTRUCTION

- All storefront construction shall be self-supported from the floor and independent of the building fascia and bulkhead structure.
- Storefronts may be braced to the overhead structure within the Tenant space.
- Connections to the deck, mall mechanical, electrical, plumbing, or fire protection equipment for support is not permitted. This includes ceiling splay wires.
- Refer to zone plans for required storefront heights. Please contact Tenant Coordinator for details. Those Level 1 Tenants whose storefronts are required to extend up to 17' 3/4", must install their storefront materials over and affix to the Mall's existing bulkhead. The bulkhead is not to be removed.
- Level 2 Tenants with air diffusers along the top of their storefronts must incorporate within their storefront design.



> DESIGN CONTROL AREA

The Design Control Area (DCA) is the zone extended from the storefront lease line to 6'-0" inside your space, including all display windows and retail graphics, display fixtures, signs, materials, finishes, color and lighting fixtures within the area.

At Macerich, we take special interest in the DCA as an extension of the retail presentation and showcase of the store's merchandising. The intent is to convey excitement, and give the consumer a reason to shop.

Use of a professional Visual Merchandisers is highly encouraged. Design drawings shall have a display layout plan. The layout plan shall have cut sheets for fixture and/or mannequin types and include photographs of any existing Storefronts a Tenant may have that will enhance the layout plan. A rendering is required if photographs are not available.

Stores with both interior and exterior presence must activate both DCA areas. Tenants are encouraged to maintain open visibility into their Store to draw in Customers.



> REQUIREMENTS / WINDOW DISPLAYS / PROHIBITED ELEMENTS

DESIGN REQUIREMENTS

- Ceiling must be a hard surface.
- Lighting fixtures must be consistent with the character of the Storefront design.
- Recess all lighting fixtures.
- A minimal profile track lighting system matching the color of the ceiling plane is allowed.
- 6" durable base along the entire lengths of the storefront is required, including any permitted pop out areas.

WINDOW DISPLAYS

Displays should be deliberate and integrated into the Storefront. Modulation of display systems and built-in architectural components will reinforce the design.

- Display cases must be adequately lit and ventilated.
- Digital monitors are permitted within 10'-0" behind glazing if integrated into the design and approved by Landlord. Coordinate with Tenant Coordinator for exterior applications and to confirm code or local requirements.

PROHIBITED DESIGN ELEMENTS

- Track lighting is not permitted in the DCA.
- Temporary signs for sales or clearances shall not be hung in the DCA or affixed to the glass inside or outside.
- No pegboard, slat wall or metal shelving of any kind may be placed in or extend into any part of the DCA.
- Security devices or freestanding pedestals are not permitted. They must be integrated and concealed.
- Carpet, vinyl or rubber materials of any sort will not be permitted within the DCA.
- Exposure of incandescent bulbs and/or fluorescent tubes are not allowed.



> MATERIALS

As an important aspect of presenting the Tenant's unique brand image, finish materials are to be composed, articulated and executed in a creative and quality manner.

All materials and applied finishes on the Storefront are to be high-grade, durable, non-corrosive and code compliant. They are to be maintained by Tenant at the Tenant's expense. All materials and finishes are subject to Landlord approval, and the inclusion of natural materials is encouraged.

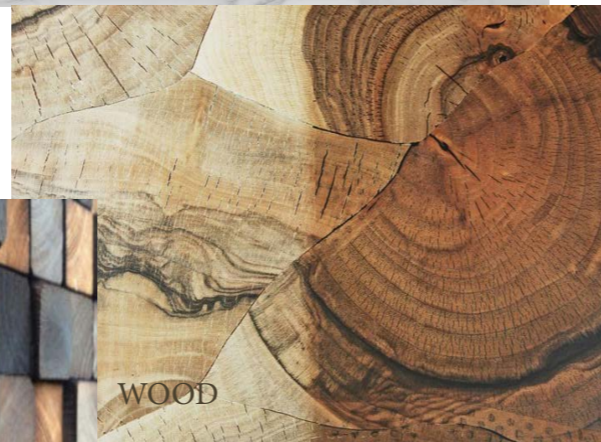

> GLAZING / DECORATIVE GLASS

GLAZING

Storefront glazing, particularly clear glazing, is a key component to establish design character and create an invitation for the customer to visit.

- A minimum of 60% of the Storefront is to be display windows with clear glass.
- Reflective glass (including extensive use of mirror) and/or tinted glass is not permitted on Storefronts or in the Storefront entry zone.
- Tinting or films applied after the glass is installed is prohibited.
- All glass shall be tempered. Glazing must be a minimum of ½" thick, and large panes of glazing must be of sufficient thickness to meet code and be properly supported.
- Tenants may be required to provide seismic clips to stabilize tall expanses of glass. Silicone sealant at glazing joints is not permitted.
- Butt-joint glazing is encouraged for show windows that in-fill larger Storefront forms. Glass shall be clear polished plate or tempered glass as required by code.
- Window mullions are required to meet all material and finish standards.
- Decorative glazing such as colored, beveled, sandblasted or etched glass may be used to create accent pattern and interest. Decorative glazing can be used as an accent, but must meet all material standards.
- Storefronts taller than 16' will be required to have a minimum glazing height of 12'.

DECORATIVE GLASS

Decorative glass may be considered to provide a unique feature to the storefront.

- In frame-less assemblies, glass panel joint details edges must be polished, ground or chamfered. Glazing channels at corner conditions must be mitered.
- All exterior glazing units must have a solar heat gain coefficient (SHGC) of not more than 0.27 and a U-value of not more than 0.28.
- Exterior glass must be a minimum of 1" insulated, low E units. 0.27 and a U-value of not more than 0.28.



> STONE / PLASTER / DECORATIVE GLASS

WOOD

Wood material can be used for Storefront construction but must comply with all local and national code requirements.

- Applications of painted or stained wood may include window frames, decorative trim, molding and solid areas, such as decorative bulkheads. In some cases, it may be used for larger architectural elements, such as columns and entablatures.
- Wood paneling and plank construction are not acceptable unless presented in a highly imaginative concept and approved by the Landlord.
- Wood specified for interior Storefronts must be kiln dried, mill quality hardwood and must meet local flame spread requirements (Class III 76-200), as well as comply with all code requirements.
- Painted wood must have a shop quality enamel finish. Wood without a paint finish must receive a clear, preservative sealant.
- A mock-up of the materials, colors, textures, or application may be required at Landlord's discretion.

STONE

Granite, marble, limestone, travertine, slate, adoquin and other natural stone materials may be used for Storefront applications.

Stone may be polished, unpolished, sandblasted, flamed, honed, split-face or carved.

- Natural stone must be protected against staining and discoloration by means of sealers appropriate to the material.
- Craftsman-like attention to detail is required at all connections and transitions to other materials, and we recommend utilizing metal reveals for a clean finish.
- Corner and edge details must prevent visible unfinished edges. Exposed edges must be quirk mitered, chamfered or polished to match adjacent surface finish.

PLASTER

Cement plaster (stucco) and Venetian plaster finishes may be considered for limited storefront applications.

- Apply an even texture of light dash, sand or smooth finish.
- Plaster or stucco should not be the primary Storefront material. Finishes should be used in combination with other high quality materials.



> METAL / LEATHER

METAL

Metal panel may be used to provide alternate texture on a portion of the storefront.

- High quality is expected for all metal applications, including careful finishing and quality fastener detailing.
- Metals may include: shop-painted aluminum and steel, stainless steel, solid brass, bronze, pewter, or enamel coated steel, and may be used for hardware, trim and panels when well designed and detailed.
- The following notes on metal material details must be called out on the submitted drawing set:
 - Minimum 1/2" thick fire-rated plywood or other solid substrate is required behind all metal panels.
 - Minimum 18 gauge metal panels are required.
 - All seams between metal panels must be identified on the storefront elevation and must be properly addressed during design review process.
- The following metal surface treatments are not allowed:
 - Oil canning (resulting from light reflection on an uneven or buckled surface)
 - Scratches
 - Warps, dents, occlusions
 - Visible seams or other imperfections
- Reveals, turn-in seams, welding or similar must be specified and detailed for approval. Metal panels will not be allowed to directly come into contact with adjacent panel or other materials.
- No visible fasteners are permitted.
- Lap joints and seams must be even, straight, and concealed when possible. Outside corners are to be mitered or continuous break shaped.
- Sealants on natural metals are required to prevent tarnishing and must be maintained by Tenant at Tenant's expense.



LEATHER

The use of leather "tiles" for vertical application can add a level of depth and texture to the Storefront. However, these tiles should not be used at an elevation that can be reached by the general population due to the delicate finish and to prevent damage over time.

- The Landlord recommends keeping the use of leather tiles on the Storefront above 7'-0" AFF.

> WALLCOVERINGS / SOLID SURFACES

WALLCOVERINGS

Wallcoverings can add depth and texture to Tenant Storefronts, but need to be applied accordingly based on the durability of the product.

Vinyl, Paper, or Fabric Wallcoverings are not considered durable and are expressly prohibited in the use of Tenant Storefronts.

- Any wallcoverings located at pedestrian level (below 7'-0" AFF) must be extremely durable and rated by the manufacturer for high traffic use.
- Any wallcoverings located above pedestrian level (higher than 7'-0" AFF) must be durable and washable for maintenance purposes.
- Removable/repositionable wall coverings are not permitted for Storefront use.
- All wallcovering applications must appear seamless and be securely affixed with commercial grade adhesive rated for high traffic use covering the entire back of the product.
- All maintenance of wallcoverings is by Tenant. No peeling, bubbling, or other separation of the wallcovering from the applied substrate is permitted to remain, and is the responsibility of the Tenant to repair in a time frame deemed acceptable by the Landlord.



SOLID SURFACE

The use of large format solid surface panels can effectively mimic luxury materials in places where cost may be an issue (IE: Caesar Stone or Cambria), or to provide even, diffuse lighting elements in the storefront (IE: Lumicor or 3Form).

- All solid surface products must be rated for heavy duty commercial applications – residential quality products are not permitted.
- Joints, flat seams, and corner conditions of solid surface materials must be tight and seamless.
- All visible edges must be finished to the same level and quality as the front face of the material.
- If the body of the product is not consistent throughout, a mitered corner detail is required to keep the presentation clean.
- All corners and edges must be eased for safety purposes.
- No adhesive can be visible in the final application.



> PAINT / FAUX FINISHES / FABRICS / TILE

PAINT

- Surfaces should be maintained as an even and durable surface finish, at all times.
- Any paint application should show uniformity without evidence of touch-ups or batch variation.
- Paint should be colorfast, and well executed to prevent lap marks, brush marks, or poor coverage.
- Surfaces and materials shall be prepared and staged correctly to avoid problem conditions such as poor adhesion, sagging, chipping or flashing.
- Painted metal surfaces are not allowed.
- Painted gypsum board is not permitted on the storefront unless there is a factory applied finish of baked enamel or powder coat treatment.
- Painted MDF may be used with a finish process of 1 coat primer, 2 coats finish (sprayed and sanded between each step). Minimum thickness of the MDF is 3/4" on Storefronts.

FAUX FINISHES

Faux finishes may be used at the Landlord's discretion.

- Actual samples of the faux finish must be submitted to the Landlord. Photographs of previous examples are helpful but may not be substituted for an actual sample.
- Faux finishes must be executed by a commercial artisan specializing in that medium.

FABRICS

- Fabrics shall be commercial grade and tested in accordance with ACT Guidelines.
- Specifics for flammability and four aspects of fabric durability: Wet & Dry Crocking, Colorfastness to Light, Physical Properties, and Abrasion are to be documented for each fabric specified and available for Landlord review if requested.

TILE

- Tile may be used in diverse applications and is encouraged to introduce light, texture, and graphic quality to a Storefront.
- Porcelain, cermaic, or glass tile in glazed or natural finishes may be used as accents and in limited field applications. Patterns over a large area must be sophisticated and well executed.
- Small intricate mosaic tile may be utilized for detail and accents only.
- Lapped or butt joints are not permitted. Outside cornered must be bull nose edge or special corner trim.
- Grout color should match the background color of the tile so as not to emphasise the grid.



> INTERIORS > LIGHTING / FLOORING

The store interior design should emphasize your merchandise and create an exciting experience for the customer.

It is the Tenant's responsibility to survey, capture and address all existing conditions within the space.

LIGHTING

Lighting can greatly contribute to the design of a Tenant's store, by emphasizing architectural forms as well as highlighting signage, adding color and visual drama to walls and other design elements. The creative use of dramatic lighting is encouraged at entries, show windows and merchandise displays.

- Fixtures must be positioned to avoid glare directed into public areas. Do not over light.
- Wall sconces or decorative lamping may be used to cast light onto storefront forms, provided that bare bulbs are not exposed and that the finish and form of these fixtures coordinate with the overall Storefront design. Fixture cut sheets are required.
- Sconces shall be commercial grade in quality and size.
- Residential scaled sconces are not acceptable.
- Colors are subject to Landlord approval.
- 2'x2' or 2'x4' prismatic fluorescent lights are not allowed.
- Track lights shall be finished to match the ceiling.
- Strobe, spinner, or chase type lighting is not permitted.



FLOORING

- Finished flooring is required in the full premises including in the recessed entry conditions and storage areas of the store.
- Hard surface base is required in all sales areas.
- Ensure floor material is durable and non-slip.
- Carpet must be commercial grade and meet local code required fire-proof ratings.
- Exposed concrete floors must be sealed.
- Transitions between flooring and common areas must be flush.
- Tenant is responsible to mitigate any/all ADA issues and clear with the appropriate municipality.



> CEILING / WALLS & PARTITIONS

CEILING

- Stores 800 s.f or less must have a gyp board ceiling, not an acoustic panel ceiling.
- Recessed entry conditions must have a finished soffit matching the storefront.
- Concealed light covers to highlight architectural elements are encouraged.
- Multi-level ceilings are encouraged.
- Gypsum wallboard, concealed spline, decorative patterned ceiling panels, and other “high-tech” materials are encouraged.
- Standard 24” x 48” acoustical panels are not allowed in sales areas.
- Sprinkler heads are to be fully recessed in hard or acoustical ceilings.
- All ceiling material shall be non-combustible. No combustible materials may be used above the finished ceiling.

WALLS & PARTITIONS

- Demising walls are not designed to accommodate cantilevered or eccentric loads. If Tenant plans to use a demising wall for support of shelf standards, light soffits or heavy attachments, Tenant shall reinforce the wall as required by providing additional steel studs or independent supports for the shelf standards.
- Demising walls and ceiling shall be sound insulated to achieve a minimum STC rating of 50 by Tenants who produce above 80 dB (including but not limited to music stores, arcades, etc.) The Landlord will strictly enforce all Tenants’ right to quiet enjoyment of their Leased Premises.
- Tenant shall protect fire proofed columns and braces with gypsum board, and furr as required.
- The following are required for hair salons, pet shops and all food preparation type Tenants:
 - Walls containing “wet” areas to be constructed of metal studs with water resistant 5/8” type “x” gypsum board.
 - Demising walls of pet shops shall have sheet metal installed on studs, behind drywall, up 3’-0” from floor.
- When Tenant chooses not to install a ceiling within Tenant’s stockroom, Tenant shall extend the partition separating the stockroom from other areas of the store, to the underside of the structure above in order to isolate the stockroom from the sales area attic space. Tenant to verify if this is allowed by code.
- Metal or plastic laminate inserts are required for slatwall. No visible substrate at slats.
- Recessed wall standards are permitted.
- No open shelving with visible brackets or surface mounted systems are allowed.



> EGRESS DOORS / RESTROOM

EGRESS / SERVICE DOORS

- All secondary exit doors shall be backset so that the door does not swing into the corridor, or exit passageway.
- Doors entering a common exit passageway or corridor shall be labeled with the Tenant name and space number.

RESTROOM

- 3" Floor drain and cleanout are required.
- Each restroom must have an exhaust system.
- A waterproof membrane beneath the finish floor surface up to a height of 4" along all walls is required.
- Floor finishes in toilet rooms shall be ceramic tile with a coved 6" base. Tenant is required to provide a waterproof membrane beneath the finish floor surface up to a height of 4" along all walls.
- Toilet room walls and ceiling shall be constructed of metal studs with water-resistant 5/8" type "x" gyp board.
- A water shut-off valve is required at eye level.



SIGN CRITERIA > CONTENTS

PRIMARY SIGNAGE

- CONTENT / DESIGN ELEMENTS*
- PLACEMENT / DIMENSIONS / CONSTRUCTION*

SECONDARY SIGNAGE

- WINDOWS / THRESHOLD*
- AWNINGS / BLADES*
- PROHIBITED ELEMENTS*

EXTERIOR SIGNAGE

- LIGHTING / DIMENSIONS / DESIGN & FABRICATION*
- INSTALLATION / SPACE IDENTIFICATION*

SECTIONS OF INTEREST

- BUILDING DETAILS*
Includes property reference photos and specific Storefront design details.
- PROPERTY INFO*
Includes information on the Property's building codes, area permitting, and required contractors.
- SUBMITTALS*
Outlines requirements on how and what to compile for submittals to the Landlord for design reviews.
- ADDENDUM*
Includes additional info on exterior signage requirements.

Storefront signs are vital to the successful function of the Center.

The goal of this Criteria is to produce a colorful collage of signage that tastefully informs, delights, and stimulates the shopper.

All sign materials must be consistent with the design theme, enhancing the storefront and evoking a positive retail image.

Due to the variety of architectural treatments within the Center, each Storefront sign will be carefully considered in relationship to its particular location. What may be appropriate in one location may not work in another. Each proposed sign will be evaluated on its originality and compatibility with neighboring signs, and its overall image within the Shopping Center.

The Landlord reserves the right to disapprove any sign design that is not compatible with these criteria and the aesthetics of the Shopping Center.

This Criteria is intended to harmonize with the leasing documents. It is the responsibility of the Tenant to forward a copy of these Criteria to their architect, contractor and various consultants.

No deviation from the enclosed Criteria requirements will be accepted without prior written approval from Macerich.

Signage design and construction must be code compliant.



> PRIMARY SIGNAGE

Your primary sign is an opportunity to express your Brand's identity and individuality at the entry portal of your store.

The following sign types are encouraged as design options for your primary signage:

- **REVERSE CHANNEL (HALO LETTERS)** minimum of 3" deep and projected from the background.
- **INTERNALLY ILLUMINATED** sign housings having unique shapes with letters routed out and formed letters protruding beyond the routed out letter.
- **EDGE-LIT, SANDBLASTED GLASS** with a continuous light source.
- **CAST METAL LETTERS** raised or flush with the fascia surface.
- **GOLD LEAF** on glass or stone.
- **SILK-SCREENED** glass or metal panels.
- **INDIRECT ILLUMINATION** on non-internally illuminated signs (artisan type panel signs).

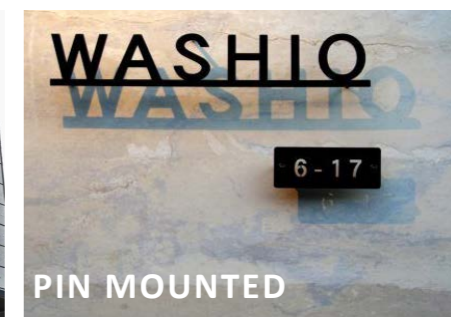
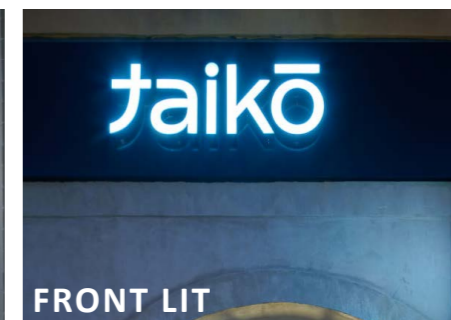
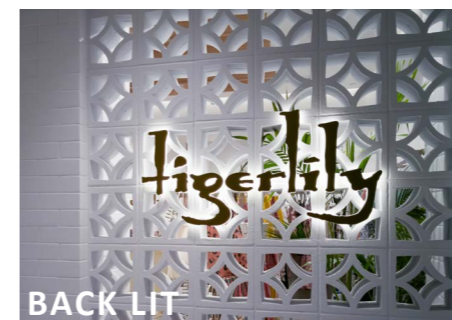

> CONTENT / DESIGN ELEMENTS

SIGN CONTENT

- Sign wording is limited to the Tenant's trade name and shall not include specification of merchandise sold or services rendered, regardless of the Tenant's legal name. Corporate crests, logos or insignia may be acceptable pending the Landlord's approval and provided they are part of the Tenant's name.

SIGN DESIGN ELEMENTS

- All primary Storefront signs must be illuminated. External illumination designs are subject to Landlord approval.
- Imaginative signs utilizing a variety of materials are encouraged. Adaptation of current sign practices may be necessary in order to comply with these criteria.
- Backlit components must be contained wholly within the depth of the letter. Maximum brightness may not exceed one hundred (100) foot-candles.



> PLACEMENT / DIMENSIONS / CONSTRUCTION

SIGN PLACEMENT

- One sign is permitted per store frontage unless additional signage is approved by Tenant Coordinator. Tenants occupying corner spaces may utilize one sign per elevation with a maximum of two (2) signs, or one sign on a diagonal corner. For unusually long tenant storefronts, more than one sign may be allowed, with Landlord approval.
- Bottom of sign to be at 9'-0" A.F.F. minimum.

SIGN DIMENSIONS

- Signs shall be designed as an integral part of the storefront, with letter size and location proportional to the overall storefront design, and in compliance with the Design Criteria.
- Letter size: must be proportional. Max allowed for height of letter is 13% of overall storefront height. Example - a storefront that is 12'-0" in height will be allowed to have a maximum letter height of 18.72".
- Letter dimensions of greater proportions may be considered if, in the Landlord's opinion, the sign design is of exceptional merit and architectural quality.

SIGN CONSTRUCTION/INSTALLATION

- All Storefront signage and lighting, both interior and exterior, are required to be on a separate circuit and controlled by a time clock. Storefront signage and lighting are required to be on during operating hours and off during non-operating hours. This includes exterior building Storefront signage.
- Electrical raceways are not to be visible.
- High quality fabrications are required. Hums, flickers and light leaks are not permitted. Attachment devices, bolts, clips, threaded rods, fasteners, tubes, raceways, conduit, and other mechanisms are to be concealed. All labels must be away from public view. Signs must comply with all codes and regulations, must bear the UL label, and must have current sign permits.
- Tenant may use Landlord bulkhead for lateral bracing only.
- Threaded rods or anchor bolts shall be used to mount sign letters spaced out from background pane. Angle clips attached to letter sides will not be permitted. All bolts, fastenings, and clips shall be of hot-dipped galvanized iron, stainless steel, aluminum, brass or bronze, and no black iron materials of any type shall be permitted.
- Advertising placards, banners, pennants, names, insignia, trade-marks and other descriptive material may not be attached to the storefront or glazing.
- Visible weep holes are not permitted.
- Any existing holes from previous Tenant signage must be patched and painted.



> SECONDARY SIGNAGE

In addition to the Primary Sign, all signage visible from the exterior of the store are considered Tenant Signs. These do not include messages used to advertise products, sales, or special events.

Several various Secondary Signs are allowed at the Center and detailed in this section.

The following general Secondary Sign requirements must be met by all Sign varieties:

GENERAL

- Signs must be kept within the the lease line.
- Signs must be in proportion to the overall storefront and composition.

MESSAGING

- Trade name and/or logo only, are allowed.
- No taglines may be incorporated.
- Established logos will be allowed and will be counted in the overall area calculations.



> WINDOW / THRESHOLD

Secondary signage types and their requirements include:

STOREFRONT WINDOW SIGNS

If the Tenant wishes to provide additional Tenant identity, it is to be located at the pedestrian level on the inside face of the Storefront glass.

- Glazing signs are to be translucent (similar to frosted glass), reverse-reading and applied directly to the interior of the glass surface.
- Tenant graphics on Storefront glass shall be computer cut fat vinyl graphics (text/letter/logos)
- Maximum allowable area of signage is subject to Landlord's review and approval.
- Tenant graphics/logo will be limited to a maximum of three (3") inches in height.

THRESHOLD SIGNS

In addition to Storefront signs, Tenants are encouraged to incorporate signs into their entry way flooring. Landlord will review threshold signs on an individual basis.

- Threshold signs are to be graphics comprised of logos, crests and accent.
- Finish is to be flush with adjacent materials and consistent with entry flooring quality.
- Recommended materials are wood, tile, stone, metal and terrazzo inlays.
- Threshold signs are not to extend beyond their lease line into the Center.



> AWNINGS / BLADE SIGNS

AWNINGS

Some Tenant Storefront designs include projected awnings. Landlord will review awnings and their signage on an individual basis.

- Glass or metal are the preferred materials of choice, although fabric awnings will be considered.
- Awning signage may be considered as the main Tenant's identification at the sole discretion of the Landlord in the interior of the Mall only.
- Signage may occur on the valence of the awning and may be painted or silk screened in a contrasting color.
- Logos shall be silk-screened and submitted with awning and sign drawings. Size of the logo shall be proportionate to the overall width of the awning and subject to Landlord's approval.
- The lowest point of the awning or shade shall be a minimum of eight feet (8'-0") above the finished floor. It is the designer's responsibility to ensure that awnings conform to all applicable codes.
- Materials such as Pana-flex, plastic or other vinyl materials shall not be permitted.
- Awnings shall be cleared and maintained in good condition at the sole expense of the Tenant
- Wording on awnings is limited to Tenant's DBA only.

BLADE SIGNS

Blade Signs are not permitted at Arrowhead Towne Center.



> PROHIBITED SIGNS AND MATERIALS

PROHIBITED SIGNS AND MATERIALS

The following sign types and materials are not permitted:

- Internally illuminated plexi-faced channel letters.
- Vacuum-formed or injection-molded plastic signs.
- Cabinet or standard “can type” signs with illuminated translucent backgrounds and silhouetted letters.
- Exposed skeleton neon applied directly to fascia element.
- Temporary or ‘sales’ signs attached to Storefront.
- Freestanding tripod signs.
- Flashing, scintillating, moving, sequencing, audible or odor producing signs.
- Paper, cardboard and Styrofoam signs.
- Credit card and advertising placards, decals, stickers or trademarks.
- Manufacturer labels.
- Carpet or rubber entry mat signs.
- Internally illuminated awnings.
- Signs employing un-edged or uncapped plastic logos or letters with no returns and exposed fastenings.
- No simulated materials (IE: wood grained plastic laminates, Zolatone etc.) or wall covering permitted.
- Signs painted on Storefront.
- No radioactive material shall be allowed to be used or installed as part of any Tenant construction scope of work. Furthermore, no radioactive signs such as Tritium exit signs shall be allowed in our Shopping Centers.

> EXTERIOR SIGNAGE > LIGHTING / DIMENSION / DESIGN & FABRICATION

The following additional requirements must also be followed regarding Exterior Signage:

LIGHTING REQUIREMENTS

- Metal letters, back lit (halo effect) with warm white light (3200K^o - 3500K^o). Letters must be a minimum of 6" in depth, and must be projected from the background with one inch spacers.
- Internally illuminated channel letters, with opaque sides and plastic faces, (3200K^o - 3500K^o) luminous tubing illumination within letters. Letters should not be more than 9" in depth. The Plexi-glass color will be determined on an individual mall basis. Trim caps are to match letter color.
- Letters are to be individually illuminated with white neon.

DIMENSION REQUIREMENTS

- Store sign shall not exceed 70% of the Storefront width, a distance which shall be determined by the lineal footage of the Tenants lease line.
- Logos cannot exceed 30" square depending upon the application.
- Uppercase letters shall not exceed 24" in height.
- Lowercase letters shall not exceed 20" in height

DESIGN AND FABRICATION REQUIREMENTS

- While the letters are to be individually illuminated with white neon, the "Plexiglas" color is to be determined on an individual mall basis. Trim caps are to match letter color.
- No exposed raceways, crossovers, conduit conductors, transformers, etc. shall be permitted.
- All signage and sign components shall be UL listed.
- All exterior signage components (logos and all individual letters) shall stand off the face of the wall surface by a distance of 1/4 inch. This shall be accomplished by the use of nylon spacers placed between the face of the wall and the back of the logo or letter.
- All metal letters shall be fabricated using full-welded construction.



> INSTALLATION / SPACE IDENTIFICATION

INSTALL AND CONSTRUCTION REQUIREMENTS

- A building permit, Mall and City approval shall be obtained prior to sign installation.
- All sign installation will be coordinated with the Landlord prior to initiation of any work by the Tenant and/or his subcontractors.
- Tenant is responsible for the operation of the Tenant's sign contractor.
- The sign contractor, on drawings submitted to the Landlord, shall indicate location of all openings for conduit sleeves and supports in sign panels of building walls. Sign contractor shall install signage in accordance with the approved drawings and building codes.
- Tenant's sign contractor shall repair any damage to any finishes caused by his work.
- All signs, bolts, fastenings, and clips shall be of hot-dipped galvanized iron, stainless steel, aluminum, brass or bronze, and no black iron materials of any type shall be permitted. No toggle bolts shall be used for sign attachments.
- Electrical service to the Tenant's sign shall be installed by the Tenant and not be part of the Landlord's operating costs. The sign shall be controlled by a time clock.
- Any existing holes from previous Tenant signage must be patched and painted.

EXTERIOR SPACE IDENTIFICATION

- If Tenant has a non-customer door for receiving merchandise, Tenant may place its name and address on said door in a location approved in writing by Landlord's Tenant Coordinator, using two inch (2") high block letters. Where more than one (1) Tenant uses the same door, each name and address may be applied. Landlord's Tenant Coordinator shall also specify the size, type and color of numbers.
- Tenant may install on its Mall Storefront, if required by the US Postal Service, only the numbers of Tenant's street address and only in such location as Landlord shall specify. Landlord's Tenant Coordinator shall also specify size, type and color of numbers.



TECHNICAL CRITERIA > CONTENTS

ELECTRICAL

- POWER SOURCE / METER
- REQUIREMENTS / SYSTEM REUSE
- DATA & COMMUNICATIONS
- LIGHTING

LIFE SAFETY

- SPRINKLER
- FIRE ALARM
- EGRESS

PLUMBING

- REQUIREMENTS
- GAS

MECHANICAL

- LOAD CALCULATIONS / GENERAL REQUIREMENTS / EXISTING SYSTEMS / EXHAUST
- ROOFTOP EQUIPMENT

SECTIONS OF INTEREST

BUILDING DETAILS

Includes Property reference photos and specific Storefront design details.

PROPERTY INFO

Includes information on the Property's building codes, area permitting, and required contractors.

SUBMITTALS

Outlines requirements on how and what to compile for submittals to the Landlord for design reviews.

ADDENDUM

Includes additional info on exterior signage requirements.

The Inline Technical Criteria provides buildings details and design requirements for the Center's technical systems.

It is the Tenant's responsibility to verify existing conditions and comply with all applicable codes and standards for technical systems.

Tenants are required to adhere to the full Criteria during their design and construction.

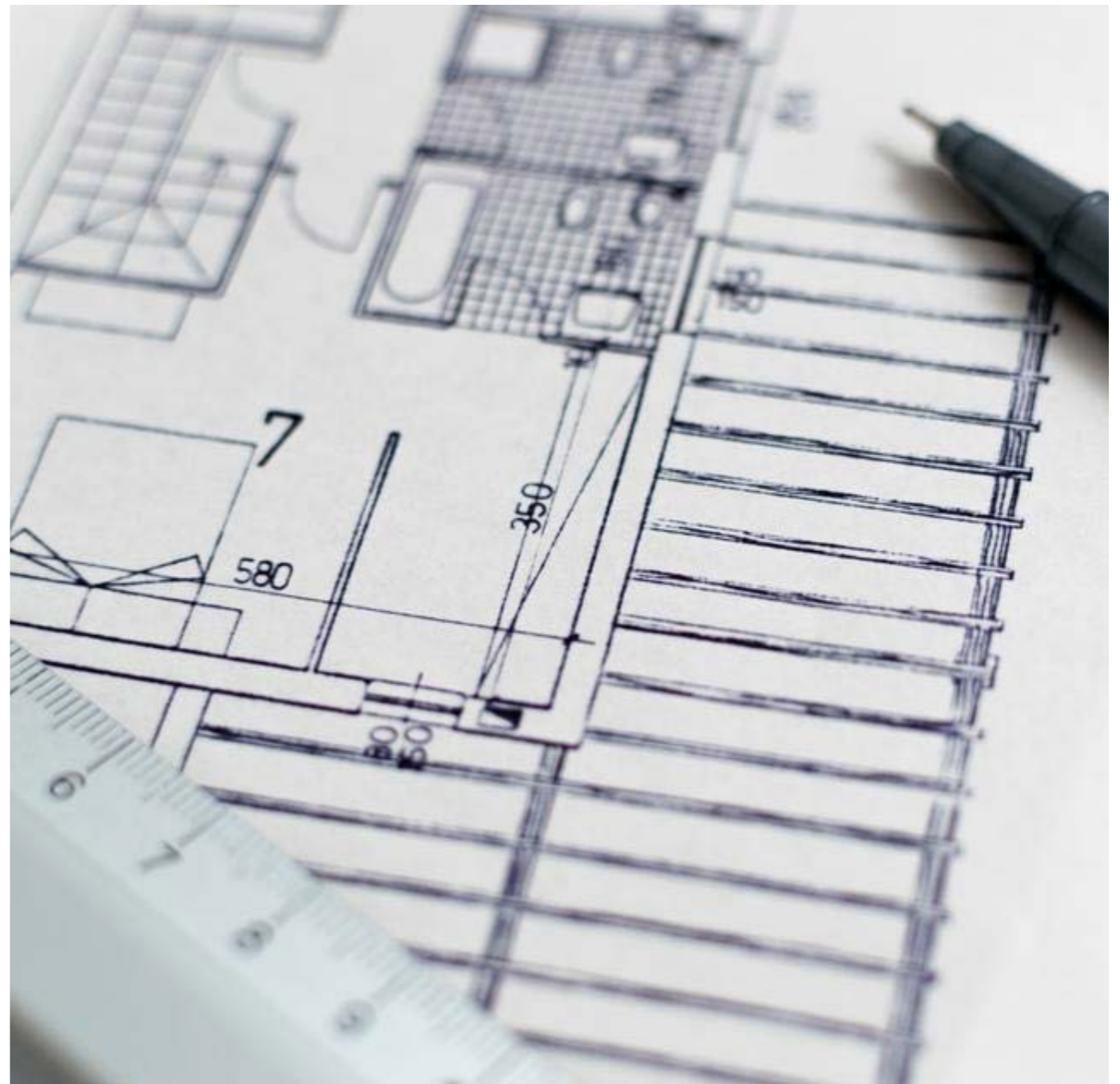

> ELECTRICAL > POWER SOURCE / METER

PROVIDED POWER SOURCE

Tenant shell spaces typically provide an empty conduit to a main power source. The main power source available for Tenant connections will be 277/480v or 120/208v, 3 phase, 4 wire available from the nearest electrical room.

The Landlord may provide temporary electrical service to the Tenant, during construction. The charge for this temporary power will be paid by the Tenant as per the Tenant Construction Rules and Regulations. Temporary wiring needed to work in the space should be connected to the Tenant's electrical service and not common area outlets.

I. TENANT REQUIREMENTS

Tenants are required to meet the following requirements related to connecting to their power source:

- **MAIN POWER SOURCE CONNECTION** must be performed by the Landlord's designated electrician, at the Tenant's expense.
- **FEEDERS** to the tenant space are the Tenants responsibility, installation of a dry type transformer, panels and complete distribution throughout their space.
- **DEMAND CHECK METER** must be installed in the mall electric room or in Tenant's space for those areas of the mall where applicable. (Check with the mall's Operations Manager or Tenant Coordinator prior to construction start).
- **UTILITY COMPANY ARRANGEMENT** is a Tenant responsibility to arrange for electrical service and meter at Tenant's expense.
- **LARGER CONDUIT**, if required, is a Tenant responsibility to install from the power source to the demised premises.
- **3-POLE DIFUSIBLE DISCONNECT** must be installed at eye level for termination of all power inside the Tenant's space.

METER DETAILS

Electrical use is sub-metered and charged by the Landlord. However, check with your Tenant Coordinator as some parts of the Center are not sub-metered. If a space is not sub-metered, it is the Tenant's responsibility to contact the Utility company for meter installation.

I. ELECTRIC METER REQUIREMENTS

- **REVENUE GRADE** meters are required.
- **DISPLAY** must be at least 6-digits.
- **METER MUST READ** demand (kW) and usage (kWh).
- **METER MUST CAPTURE** the electric usage of the entire Tenant space, including HVAC units. If this is not possible, then it must be noted.
- **METERS WITH CT** must note if a multiplier is required and what the multiplier is on the face of the meter.

II. EXISTING METERS

If there is an existing electric sub-meter in the Tenant's space:

- **RECOMMISSIONING** the meter is the Tenant's responsibility to ensure proper installation and functionality or;
- **NEW METER** may be installed by the mall required vendor, and will be at the Tenant's sole cost.

> REQUIREMENTS / REUSE

SYSTEM REQUIREMENTS

- **NO DIRECT ATTACHMENT** to the slab, roof deck, ductwork, piping or conduit above. Conduit and raceway hangers, clamps, light fixtures, junction boxes, supports, etc. must be fastened to joists and/or beams.
- **ACCESS PANELS** must be provided at all junction box locations and at smoke detectors above the ceiling.
- **IDENTIFY** all Tenant equipment in the Mall electric room with clear labels that include the Tenant name and space number.
- **TENANT EQUIPMENT** typically includes, but is not limited to: all outlet boxes, floor boxes, wire raceways, power/telephone poles, plug-in molding, wiring devices, and hanger supports for a complete distribution must be furnished and installed by Tenant.
- **EQUIPMENT POWERED BY TENANT** typically includes, but is not limited to: VAV units, water heater, store fixtures, signage, music systems and any other fixtures or equipment provided by Tenant.
- **FEEDERS** are typically the Tenant responsibility to the Tenant space.
- **UL LABELS** on all material and equipment must be new and of a commercial grade and where such labeling applies.
- **WATERTIGHT FLOOR BOXES** are required.
- **PULL BOXES/J-BOX MATERIAL** must be a minimum of 12 gauge galvanized steel outlets. Boxes in walls must be galvanized pressed steel or case metal. Caulk around boxes to eliminate noise transmission.
- **CONTROLS** including Manual or magnetic starters, switches, contactors, relays, time switches, safety devices, dimmers and other controls must be commercial type with heavy duty ratings and must be installed in strict conformance with the manufacturer's recommendation and applicable codes.
- **EXPOSED WIRING** is not permitted. All wiring of any type must be installed in conduit or must be metal clad cable (MC). Metal clad cable will only be allowed for concealed branch circuit wiring within the demised premises. Flexible conduits must be used for connections to vibrating equipment.

- **COPPER** is required for all wiring.
- **CONDUIT** is required for all wiring, including low voltage.
- **GROUND SYSTEM TO BUILDING STEEL** as structure is designed with a "UFER" grounding system.
- **MAIN CIRCUIT BREAKER** for the Tenant will be furnished and installed by the Landlord at the Tenant's expense.
- **SERVICE SIZE** requested by Tenant is subject to approval by Landlord. If the Tenant's electrical requirements exceed the standard size provided by the Landlord, the Tenant will submit total Load Calculations to confirm their requirement. Tenant is responsible to confirm the service size before work commences.
- **SLAB TRENCHING** is not permitted without written permission from the Landlord. Tenant to provide all structural support needed if trenching is permitted, including written certification to the Landlord that the trenching has not affected the integrity or weighty capacity of the slab.
- **GRADE LEVEL SLAB** requires electrical conduit to be installed at least 4" under the slab with Schedule 40 PVC conduit. Conduit must not be installed in the slab or less than 4" below slab.

REUSE OF EXISTING ELECTRICAL SYSTEMS

Tenant's electing to re-use the existing electrical system (if applicable) in their Tenant space shall:

- **SUBMIT A LETTER** to the Landlord from the Tenant's electrical engineer stating that the existing electrical system is not being altered.
- **VERIFY SYSTEM CONNECTS** to the building management system for lighting controls and Fire Alarm. Tenant shall use mall required contractor at Tenant's expense to ensure code-compliant, connected system is complete.

> DATA & COMMUNICATIONS / LIGHTING

DATA AND COMMUNICATIONS – INSTALL AND PROVIDER REQUIREMENTS

Telecommunications service is provided and administered throughout the Center by Granite Grid. The service includes a dedicated concierge customer service representative for each Tenant, high-bandwidth service (tailored to suit Tenant demand), centrally coordinated installations, moves and repairs.

- **ACCOUNT SETUP AND SERVICE INSTALLATION** is the Tenant responsibility to coordinate direct through Granite Grid. Other data providers are not permitted at this property as they do not have an access agreement in place. **It is highly recommended to coordinate service install a minimum of 4 weeks in advance.
- **TELEPHONE DEMARC WORK** must be performed by Landlord's approved telephone subcontractor.
- **TELEPHONE SERVICE** is the Tenant responsibility to contact the local Telephone Company and install within their premises.

LIGHTING – SYSTEM REQUIREMENTS

- **LIGHTING IN TENANT SPACE** is the Tenant's responsibility. The Tenant will not install any lighting outside the Tenant's space with the exception of Mall required standard lighting at back doors. These fixtures shall be photo cell controlled.
- **LIGHTING SCHEDULE** is required for review in conjunction with a reflected ceiling plan.
- **TIME CLOCK** is required to control display window lighting and be on during the hours the Shopping Center is open.
- **DISPLAY WINDOW LIGHTING** at the ceiling must be glare-free and at approved levels at the storefront glass line and not hang down below the top of storefront glass.
- **RECESSED INCANDESCENT DOWN LIGHTS** are permitted.
- **DECORATIVE LIGHTING FIXTURES** for storefront illumination, such as luminous ceilings, chandeliers, pendant or wall units or clear type glitter strips are permitted if approved by Landlord. No strobe, spinner or chase type lighting shall be used.
- **CODE REQUIRED LIGHTING** such as exit, emergency and night lights must be provided throughout.
- **SALES AREA FLUORESCENT LIGHTING** must be recessed and must use metal parabolic louver type lenses with a minimum of 18 cell configuration for a standard 2' x 2' fixture. Bare lamp fluorescent or fluorescent fixtures with acrylic prismatic lenses may be used only in concealed areas or stock rooms.
- **TRACK LIGHTING** may be used if the track is painted to match the ceiling color.
- **LIGHTING CONTROL SYSTEM** is the Tenant responsibility, including connection to the Building Management system and connection to the Fire Alarm system.

> LIFE SAFETY > SPRINKLER / FIRE ALARM / EGRESS

SPRINKLER SYSTEM REQUIREMENTS

- **SPRINKLER MODIFICATIONS** are the Tenant's responsibility, designed and installed in accordance with NFPA 13.
- **SPRINKLER DESIGN AND INSTALLATION** must be performed by the mall required sprinkler contractor.
- **DESIGN CONTROL AREA** requires flush mount heads.
- **FIRE EXTINGUISHER REQUIREMENTS** are the Tenant's responsibility to confirm with the local or state fire marshal relating to quantity and location of fire extinguishers. At minimum, Tenant is to install at least one wall hung, 2A 10BC dry type U.L.- listed fire extinguisher.
- **PIPING** must be as close to walls and as high to underside of roof framing as possible.
- **LANDLORD NOTIFICATION** is required in writing at least 24 hours in advance of making any modifications to the sprinkler systems. Contractor must notify the fire department and any alarm monitoring company for verification that the system is fully drained. The contractor must notify the Landlord when the system is back on line.
- **CLEARING ALARMS** must be coordinated with Security or Mall maintenance supervisor at least 60 minutes prior to any drain down. Contractor shall remain for one (1) hour after the system has been refilled to check for leaks or other problems.
- **OVERNIGHT DRAINING** is not permitted. All systems have to be charged and operational when worker leave for the night.
- **SPRINKLER WORK HOURS** can be conducted at any time as long as system does not need to be drained. If System needs to be drained for new tie-ins to main line, then it can only be done after hours for Public Safety. System then needs to be filled and tested before mall operating hours. See the Tenant Contractor's Rules and Regulations for the cost for each shut down of the system, which required to be paid before the system is drained. The Mall staff of approved contractor will drain and fill the system.

FIRE ALARM REQUIREMENTS

- **FIRE ALARM DETECTION SYSTEM** is a Tenant responsibility to provide within the Tenant space as an extension of the Landlord's building-wide addressable fire alarm system.
- **FIRE ALARM INSTALLATION** must be performed by the Landlord's designated contractor.
- **FIRE ALARM TIE-IN** to the building wide addressable system must be performed by the Landlord's designated contractor.

EGRESS REQUIREMENTS

- **FIRE BARRIER FROM ADJACENT SPACE** must be separated by at least 1-hour fire barriers with 60 minute opening protectives.
- **FIRE BARRIER FROM EXIT STAIR DISCHARGE** must be separated by 2-hour fire barriers with 90 minute opening protectives.
- **AUTOMATIC SPRINKLER SYSTEMS** must protect passageways.
- **SMOKE DETECTION SYSTEM** must protect passageways.
- **GAS PIPING**, if distributed along the exit passageway routes, will be separated from the exit passageway by fire rated construction and will not be considered to be located within the exit passageways.
- **ALLOWED UTILITIES** in exit passageways are limited to; Electrical wiring (no higher than 480 volts phase-to-phase and 277 volts phase to-neutral) in electrical conduit, Low-voltage wiring (security, music, telephone, data, etc.), enclosed junction boxes, Fire alarm equipment and wiring, Noncombustible piping, and Mechanical ductwork.
- **PROHIBITED UTILITIES** in exit passageways include; Electrical equipment such as panels, switchgear, and transformers, Grease traps, and Natural Gas piping.

> PLUMBING > METER / SYSTEM REQUIREMENTS

SYSTEM OVERVIEW

Tenant shell spaces are typically provided a domestic cold water line and sanitary line stubbed into the space.

The following criteria must be followed during the design and construction of the Tenant space:

WATER METER REQUIREMENTS

- **VERIFICATION AND APPROVAL** of install must be obtained by the Operations Manager, or a member of the Operations staff at the property.
- **PROOF OF INSPECTION** sent to the Tenant Coordinator including:
 - Date of installation or recommissioning
 - Meter make and model
 - Picture of the meter at time of installation or recommissioning
 - Units that the meter reads in
 - Multiplier, if applicable
 - Confirmation that the meter covers whole tenant space

SYSTEM REQUIREMENTS

- **SHUT OFF VALVE** located at eye level in a wall behind a labeled access door is required. Locate in or near employee restroom and/or as designated by Landlord.
- **COPPER** is required for all domestic supply lines and condensate lines.
- **ELECTRIC WATER HEATERS** are required for domestic hot water with a secondary drain pan installed underneath it and piped to a floor sink..
- **SANITARY VENTS** through the roof shall be a minimum of 4" and extend a minimum of 8" above finish roof. All roof repairs to be by the Landlord's required roofer at Tenant's expense.
- **ABOVE GROUND SANITARY VENTS** (other than food waste) must be service weight BUILcast iron, with fittings matching the same weight as the pipe.
- **FLOOR DRAINS** are required in the toilet room and in all "wet" areas.
- **WATERPROOFING** must be installed in all "wet areas" such as kitchens, restrooms, mop sinks, drinking fountains, etc. The waterproof membrane must extend 4" vertically on all demising walls. This membrane will be water tested by the General Contractor and inspected and signed off by Mall Personnel. If the membrane fails the water test, it must be replaced.
- **CLEAN OUTS** must terminate flush with the finish floor or wall. No clean outs are permitted above the ceiling. Floor or wall cleanouts must be provided every 50' with ready access.

- **GARBAGE DISPOSALS** are not allowed.
- **HAIR SALONS/PET SHOPS** must provide hair and solids interceptors on all sinks and basins which may receive human or animal hair. After installation, these hair interceptors shall be properly maintained so as to keep the sanitary system free from any adverse conditions. A maintenance contract with Mall-approved vendor is required to be submitted for record with Mall Operations
- **HAIR RECEPTORS** must be installed on all sinks, basins, and special sanitary units which may in any way receive human or animal hair.
- **KITCHEN SINKS** including pot sinks, scullery sinks, pre-wash sinks and other kitchen units must be connected to a grease trap.
- **DISHWASHERS** may not be connected to grease trap.
- **GREASE INTERCEPTOR** must be designed and approved by Landlord prior to installation, especially if located outside the lease line.
- **OIL COLLECTION AND HAULING SYSTEM** is required for Tenants with fryers or other grease/oil generating equipment that does not run through an interceptor. Landlord does not provide a centralized collection point.
- **BACKFLOW PREVENTERS** are required for food service, hair salons or other Tenants with equipment or operations that have the possibility of backflow. These must be certified and acceptable to the water district and checked yearly or as required by the local authority having jurisdiction.
- **ADA RESTROOMS** are required in every Tenant space with a minimum of one water closet and one lavatory and in accordance with local code officials and must include a 3" floor drain. Mop sinks and water fountains must be installed per local code requirements. An exception to this requirement is only permitted for Food Court Tenants who are within close proximity to the public restrooms upon approval of the Landlord and local code official.
- **WATERLESS URINALS** are required in tenant restrooms when urinals are used.
- **LOW-FLOW WATER CLOSETS** using 1.6 GPF or less gallons per flush are required where water closets are used.
- **OPERATION SENSORS AND LOW-FLOW HEADS** using 0.5 GPM or less are required if Tenant is installing a Restroom.

> GAS

GAS SERVICE

Gas may be available at the Center but is generally not available to Retail Tenants. If available, Tenant, at its sole cost and expense and in compliance with local code must procure gas service to and within the demised premises and will make all necessary arrangements with the local Gas Company for such service.

I. SERVICE REQUIREMENTS

- **GAS METER INSTALLATION** at gas meter header is the responsibility of the Tenant.
- **GAS PIPING INSTALLATION**, when allowed, is the responsibility of the Tenant to provide and install. Roof piping must be placed on pillow blocks or similar arrangement. All roof repairs to be by the Landlord's required roofer at Tenant's expense.
- **PRESSURE REGULATORS** required for connection to Tenant's equipment is the responsibility of the Tenant. Coordinate with Landlord for regulator vent routing.
- **SEISMIC AND MANUAL SHUTOFF DEVICES** are required for the entire gas piping system and equipment or fixtures and color coded or identified as such as required. Seismic valves must be: UL- approved; FM-approved; or, ACSE 25-compliant. All new development and newly tenanted restaurants need to have seismic gas shut-off valves installed on Landlord side of the meter, at each individual space.

> MECHANICAL > LOAD CALCS / GENERAL / EXISTING / EXHAUST

Tenant spaces must provide stand-alone HVAC systems through package rooftop units placed directly over their space.

LOAD CALCULATIONS

- **HEATING LOAD CALCULATION** must maintain the minimum space temperatures in sales and public spaces of 68 degrees F and 50 degrees F in non-public spaces.
- **COOLING LOAD CALCULATION** must maintain the minimum space temperature of 73 degrees F and a maximum of relative humidity of 55 degrees F and shall take into account all interior heat producing items such as people, equipment, roof and exterior walls.
- **MALL SUPPLIED AIR VOLUME** is 1.2 CFM/Sq. Ft. on 1st floor and 1.4 CFM'/Sq. Ft. on 2nd floor.

GENERAL REQUIREMENTS

- **VIBRATION ISOLATORS** are required to be installed on all HVAC equipment, whether on the roof or within the Tenants space.
- **MAXIMUM NOISE** criteria of NC40 is required for all spaces except kitchens and other similar work areas.
- **DUCT MOUNTED SMOKE DETECTORS** are required for systems that total 2,000 CFM or greater and must be connected to the main fire alarm panel, if applicable. Each duct smoke detector must have a remote key operated reset/test device mounted with in the Tenant space and an addressable relay module. Use Landlord's designated contractor for connection to the main fire alarm loop. The cost associated in monitoring Tenant's space will be the Tenant's responsibility and will be included in Tenants monthly billing.
- **AIR BALANCE REPORT** is required prior to closing out construction and will be performed by an independent test and balancing agency at the sole cost and expense of the Tenant.
- **BOTTOM FED HVAC** units are required for supply and return air.
- **CONDENSATE LINES** from HVAC units must be copper, run at right angles, drain into the Tenant space, and (if applicable) secured to the roof per mall required roofer's specifications.
- **RETURN AIR DUCT** must be from finished ceiling back to the HVAC unit if Tenant has stand alone units dedicated to their space.
- **VAV's** are plenum return.
- **FIRE DAMPER ASSEMBLIES** (including sleeves and installation procedures) must be UL listed and approved by the building inspector preceding installation. Install duct and ceiling access to fire dampers. Smoke detectors may be required in all return air or exhaust ductwork. The detectors will over ride and shutdown the air handling equipment when smoke is discovered.
- **FIBERGLASS DUCTS** are not permitted for HVAC trunk lines. Flex duct is permitted for run outs within the Tenant premises and is limited to a maximum distance of 4'.

EXISTING SYSTEMS

The Lease may allow some Tenants to resuse existing HVAC system equipment. In such cases, the following requirements must be followed:

- **CONFIRM** the existing system meets the Tenant Criteria requirements.
- **REPLACE** any units the Landlord deems in need of replacing. This may occur anytime during the terms of the Lease. Replaced units must adhere to the Tenant Criteria.
- **REUSE** of equipment older than 5 years is not permitted.
- **ALTERATION** of the existing system must be submitted and approved by the Landlord.
- **SUBMIT DOCUMENTATION** of the following prior to opening:
 1. A letter from an HVAC contractor asserting that the HVAC unit(s) operate in "like-new" condition.
 2. A copy of the maintenance agreement for the unit(s).
 3. Photographs of the existing unit(s) provided by the Tenant's HVAC maintenance contractor.

EXHAUST REQUIREMENTS

- **ODOR PRODUCING TENANTS** such as restaurants, pet shops, hair salons, nail salons, and the like must maintain 10% negative air pressure with respect to the Mall by providing make-up air equal to 90% exhaust air volume.
- **SEPARATE MAKE-UP OUTDOOR AIR SYSTEM** may be required to balance Tenant's exhaust system. Spaces that require exhaust must be designed to provide negative air pressure relative to adjoining conditioned spaces to prevent odor transfer.
- **ROOF MOUNTED EXHAUST FANS** must be ducted to ceiling grilles located approximately in the center and rear of the demised premises and specifically near the area where the odors are generated. The system shall be designed to cause the exhaust air to gravitate from the Mall common area to the odor producing area and then exhausted out.
- **EXHAUST FANS** must be interlocked with the light switches for the store customer service area.
- **OPERATION** of the combined HVAC and exhaust system must be on during all hours that the Tenant is open for business.
- **STORE EXHAUST SOLUTIONS** shall not include air filtration systems or bathroom exhaust fans.

> EXHAUST / ROOFTOP EQUIPMENT

SPECIFIC REQUIREMENTS FOR ODOR PRODUCING TENANTS

- **NAIL SHOPS** may be required to install scrubbers. This will be determined on a case by case basis.
- **ODOR PRODUCING AREAS** must include the necessary equipment to remove any odors. This work will be approved in writing by the Landlord and at the sole expense of the Tenant. Examples of such Tenant's include; hair or nail shops, pet shops, and food preparation shops.
- **ROOF VENTILATOR** model is required to use motor driven and factory curb Supreme upblast installed at a minimum of 40" from roof membrane to discharge. Use a gauge welded exhaust duct. Provide makeup air no less than 85% of amount of exhaust.
- **SPECIAL MAKEUP AIR** as required by special conditions such as grills, restaurant exhaust systems, etc., will be provided by the Tenant. Along with the HVAC unit, the Tenant may use an evaporative cooler.
- **SMOKE DETECTORS** may be required in all return air or exhaust ductwork to override the air handling equipment and provide shutdown when smoke reaches the equipment.

KITCHEN EXHAUST REQUIREMENTS

- **LANDLORD REVIEW** is required to ensure the exhaust does not compromise the ventilation air of adjacent mall roof top units.
- **EXHAUST FAN** must be a SWSI centrifugal fan which must be fitted with a minimum 10' stainless steel upblast. Guy wires must be attached to the roof in order to secure the stack. Use the mall roofer for connection of the guy wires at Tenant's expense.
- **GREASE GUARD CONTAINMENT SYSTEM** (or approved equal) must be installed to protect the Landlord's roof. A quarterly maintenance program must be in-place for the grease containment units. Proof of the maintenance contract must be presented to Operations Manager prior to the store opening.

ENERGY MANAGEMENT REQUIREMENTS

- **ALL VAV (VARIABLE AIR VOLUME) BOXES** shall be fully functional and need to be shaft type with cfm tube sensors for proper interface with DDC controls. If not, it needs to be replaced at tenants' expense.
- **NO FAN POWERED VAV (VARIABLE AIR VOLUME) BOXES** or electric duct heaters allowed.
- **ALL HVAC CONTROLS** must be interfaced by the landlord's controls contractor. All DDC (Direct Digital Controls) controls must be purchased and installed by the landlord's controls contractor at the tenants' expense. Contact Mall Operations Manager for required contractor.
- **TENANT SHALL BE HELD RESPONSIBLE** to maintain the good integrity of the EMS (Energy Management System) network cable color coded blue within their space during

all phases of construction. If damaged or cut, it shall be replaced at tenants' expense. Contact Mall HVAC Department for any questions.

- **MUST PROVIDE 120 VOLT POWER**, to all VAV (Variable Air Volume) boxes on a dedicated circuit from the breaker panel within the tenants' space.
- **ACCESS PANELS** must be provided for all landlord serviceable equipment, which is above any hard ceiling areas.

ROOFTOP EQUIPMENT REQUIREMENTS

- **PIPING** for the rooftop equipment must be provided and installed by the Tenant in coordination with the Landlord.
- **INSTALLATION INFRASTRUCTURE** including all curbs, supports, lintels, pipes, ducts, vent caps, air inlets, exhaust hoods, louvres, flashings, counterflashing's, etc. are the Tenants responsibility.
- **CURB ADAPTERS** are only permissible at the discretion of the Landlord.
- **PAVERS** must be placed around the roof top equipment and from the main pathway to the equipment in order to protect the roof from traffic.
- **EQUIPMENT SCREENS** for rooftop shall meet Landlord requirements.
- **PAINTING EQUIPMENT** including screening, equipment, ductwork, and piping is required to match the roof deck per Landlord specifications.
- **ROOF MEMBRANES** are required for mounted grease exhaust equipment and shall be a single 60mil sheet of TPO roof membrane, loose and laid over the base mall primary roof membrane. This additional sheet of TPO shall be installed minimum 5' beyond all roof top kitchen equipment and help in place by concrete pavers at the corners and or as required to keep the membrane in place and afford the ability to replace as necessary when it becomes soiled.
- **LABELS** are required on all Tenant equipment.
- **ABANDONED EQUIPMENT** must be fully removed, including any associated curbs and patched accordingly.
- **120-VOLT OUTLETS** are required for all HVAC units from the Tenant's electrical service mounted to the unit on the rooftop.
- **EXPOSED DUCTWORK** is not allowed on the roof.
- **WEATHERHEAD** is required when multiple A/C refrigeration lines penetrate the roof.
- **SEAL NEW PIPE PENETRATIONS** though the roof with new prefabricated lead or metal pipe sleeve flashing. Flashing flanges should be installed in a manner acceptable to the roofing manufacturer and the Landlord.
- **CONTROL AND ELECTRICAL WIRING ROOF PENETRATIONS** shall be made through the equipment curb or roofer required flashing.

> ROOFTOP EQUIPMENT

I. ROOFTOP EQUIPMENT LOCATION REQUIREMENTS

- **DISTANCE BETWEEN FRESH AIR INTAKE AND EXHAUST** units shall be a minimum of 15’.
- **FRESH AIR INTAKE** cannot draw in from Tenant exhaust. It is the sole responsibility to design and locate the distance such that Tenant’s exhaust cannot be drawn into the Fresh Air Intake of ANY existing roof top equipment.
- **DISTANCE ROOF PENETRATIONS** so that they may not be so close to one another that they interfere with proper flashing, or be installed in any roof waterway or area of the roof which ponds water. If placement of any curb or platform causes restriction of water flow and/or creates a ponding situation, a cricket will be constructed at the upslope side of the curb. Crickets can be formed from Perlite roof insulation to provide a minimum slope of 1/4” per foot.
- **DISTANCE BETWEEN NEW IMPROVEMENTS** and existing parapet walls, equipment curbs, or any rooftop projection, should be no less than 24” to allow for proper flashing and sealing of the roof membrane.

II. ROOFTOP STRUCTURAL REQUIREMENTS

- **STRUCTURAL ENGINEER** registered in the state in which the work is being performed must be used to design and evaluate equipment placement and provide structural drawings and detail for Landlord’s review.
- **LOCATE** roof top equipment over major structural elements.
- **REINFORCE** the roof system to adequately support the weight of any equipment added.
- **REMOVAL** of structural or miscellaneous bridging, blocking, etc., is not permitted.
- **MODIFICATIONS** to the existing structure must be approved by the Landlord before any work begins.
- **AT WORK COMPLETION** the Tenant’s structural engineer shall submit a letter stating that the roof top equipment has been installed in accordance with the engineer’s recommended design.
- **REMOVE AND DISPOSE** existing rooftop equipment that is not being used by the Tenant of at the Tenant’s expense.

III. PLACEMENT NEAR SOLAR PANELS REQUIREMENTS

- **DO NOT PLACE** equipment within 10 feet of any solar inverter or AC junction box.
- **AVOID INTERFERENCE** with solar panel production by placing objects no closer than the distance defined as 2 times their height. For example, if a 4 foot HVAC unit is installed, it must be located at least 8 feet away from a solar panel. However, in no cases, regardless of the height shall an obstacle be placed within 3 feet of solar equipment.

- **DO NOT ADD** conduits, pipes or other devices to existing conduit carrying devices.
- **DO NOT ROUTE** wires, pipes or other devices across or over existing solar equipment.
- **LANDLORD MUST REVIEW AND APPROVE** all modifications within 20’ of solar equipment.

IV. ROOFTOP WORK

- **MALL APPROVED ROOFING CONTRACTOR** is required for all roof work throughout the center.
- **WARRANTY COMPLIANCE** is the responsibility of the Tenant and mall roofing contractor.
- **ROOF ACCESS** shall be coordinated and scheduled through Mall Operations.
- **DAMAGE** to the roof structure caused by hoisting installation and the maintenance and/or servicing of Tenant’s equipment will be the sole cost and expense of the Tenant to repair.
- **QUALITY OF WORK** is subject to inspection by the Landlord and, if found unsatisfactory, reject.
- **WELDING BLANKETS** are required blankets to protect Landlords roof during any welding on the roof level.
- **WELD INSPECTIONS** may be required at the sole cost and expense of the Tenant.
- **COATING** on all materials, welds, connections, etc. installed by Tenant for the HVAC system is required to withstand corrosion.
- **WORK DURING INCLEMENT WEATHER** is not permitted. Tie-in of flashing materials to moist or dusty surfaces should not be attempted.
- **RESTRAIN** all electrical conduit, metal pipe, or plastic piping to appropriate sized wood blocking set into roofing cement. Attachment to blocking should allow for movement due to thermal expansion and contraction.
- **USE APPROVED ROOFING CONTRACTOR** to tie in platforms, curbs, and sleepers into the existing roof membrane, at the sole cost of the Tenant, in a manner acceptable to the roofing manufacturer and the Landlord.
- **WALKING PADS** must be installed to and around all associated rooftop equipment.

FOOD CRITERIA CONTENT OVERVIEW

2.1

FOOD COURT

DETAILS SPECIFIC DESIGN, SIGNAGE, AND TECHNICAL REQUIREMENTS FOR FOOD COURT TENANTS.

2.2

INLINE COUNTER SERVICE

DETAILS SPECIFIC DESIGN, SIGNAGE, AND TECHNICAL REQUIREMENTS FOR FOOD TENANTS WITH COMMON AREA FACING COUNTER SERVICE AND LIMITED OR NO SEATING.

2.3

RESTAURANTS

DETAILS SPECIFIC DESIGN, SIGNAGE, AND TECHNICAL REQUIREMENTS FOR FOOD TENANTS WITH INTERIOR OR EXTERIOR FACING RESTAURANT SERVICE.

SECTIONS OF INTEREST

- INLINE CRITERIA**
Standard design, technical, and sign requirements in addition to the contents in this section.
- DESIGN INSPIRATION**
Provides design inspirations for visual aesthetics.
- BUILDING DETAILS**
Includes property reference photos and specific Storefront design details.
- PROPERTY INFO**
Includes information on the Property's building codes, area permitting, and required contractors.
- SUBMITTALS**
Outlines requirements on how and what to compile for submittals to the Landlord for design reviews.

This Food Tenant Criteria is specifically tailored to highlight unique technical and design requirements for Tenant's cooking, preparing, and selling food products.

Through the application of the Criteria guidelines, Food Tenants will produce distinctly original designs unique to their brand and the Center. These guidelines are to help maintain a consistent design quality while still allowing each Tenant to achieve a high level of expression and diversity.

The goal is to enhance the shopping experience for our Customer through the quality and artfulness of Tenant design.

This Criteria will often point to the [INLINE RETAIL CRITERIA](#), as several requirements and design concepts are shared.

The Tenant's Architect is encouraged to contact the Landlord's Tenant Coordinator to discuss any specific design intentions prior to commencing design work. The Tenant Coordinator will strive to resolve all outstanding design issues. However, the Tenant Coordinator may, in the best interest of the Center, reject any aspect of the Tenant's design.

If an acceptable design cannot be agreed upon, the Landlord may, at the Tenant's expense, provide an additional concept Storefront design for consideration.



FOOD COURT > CONTENTS

❑ DETAILS

- ❑ *STOREFRONT ELEVATION*
- ❑ *BACK PAINTED GLASS DETAIL*
- ❑ *NEW STOREFRONT DETAILS*
- ❑ *NEW PARTIAL STOREFRONT PLAN DETAIL AND REFLECTED CEILING PLAN*
- ❑ *NEW TYPICAL SECTIONS*
- ❑ *REFLECTED CEILING PLAN*

❑ DESIGN

- ❑ *STOREFRONT*
- ❑ *FOOD DISPLAY & PREP / SEATING / QUEUING*
- ❑ *LAYOUT / SERVICE COUNTER DESIGN*
- ❑ *STOREFRONT & COUNTER MATERIALS / COUNTER ELEMENTS*
- ❑ *LIGHTING*
- ❑ *STOREFRONT CEILING / ROLLING GRILLE / NEUTRAL PIERS & DEMISING WALLS*
- ❑ *INTERIOR & PREP AREAS*

❑ SIGNAGE

- ❑ *STOREFRONT*
- ❑ *MENU BOARD*

❑ TECHNICAL

SECTIONS OF INTEREST

- ❑ *DESIGN INSPIRATION*
Provides design inspirations for visual aesthetics.
- ❑ *PROPERTY INFO*
Includes information on the Property's building codes, area permitting, and required contractors.
- ❑ *SUBMITTALS*
Outlines requirements on how and what to compile for submittals to the Landlord for design reviews.

The Food Court Criteria provides key technical information and design requirements to ensure your food service enlivens the consumer experience and interfaces with the Center's food court design.

The Tenant and the Tenant's architect assume the following important obligations:

- Fulfill the intent of the Criteria both in concept and in detail.
- Determine and respond to the actual physical conditions of the Tenant's location.
- Maintain and enhance the high standards of quality established in the construction of the Center.
- Ensure the quality of execution of all design material, finish, and detail concepts in the construction of the Tenant's improvement.
- Provide the required detail at all transitions from Tenant Storefront to neighboring Storefronts, as well as to the base building.



> STOREFRONT ELEVATION

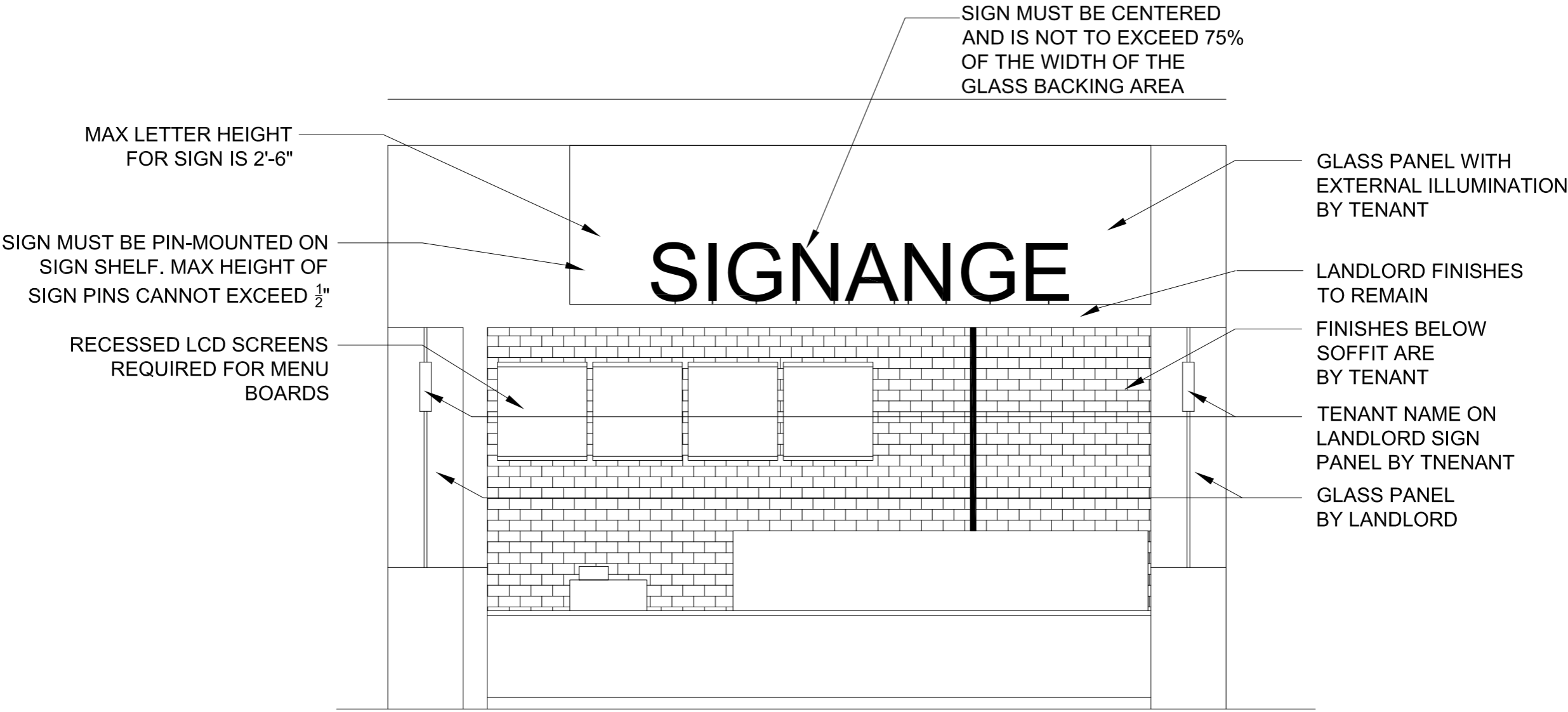

> BACK PAINTED GLASS DETAIL

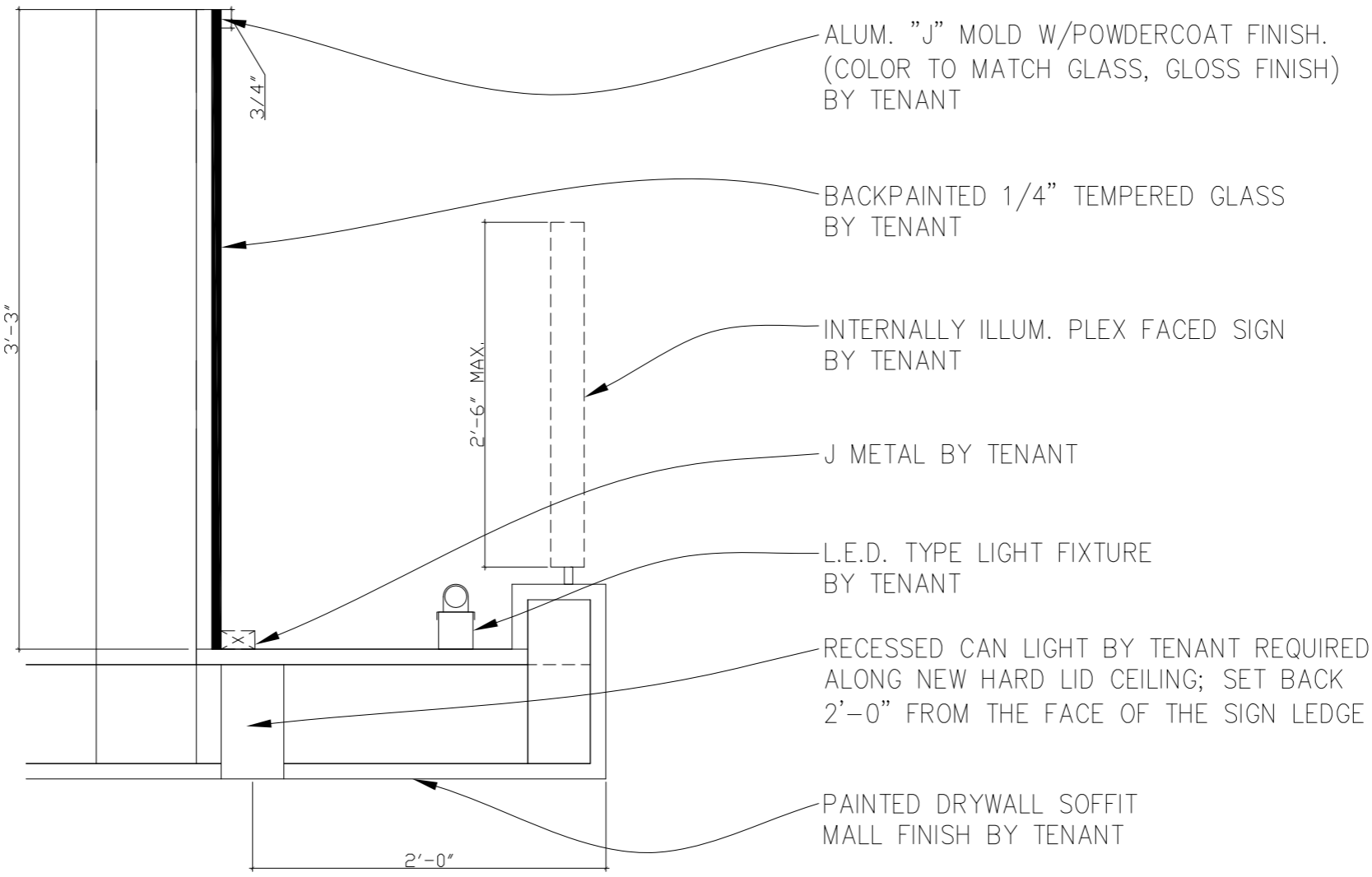

BACK PAINTED GLASS DETAIL
N.T.S.

> NEW STOREFRONT DETAILS

→ SIGN TO BE CENTER & NOT TO EXCEED 85% OF THIS WIDTH ←

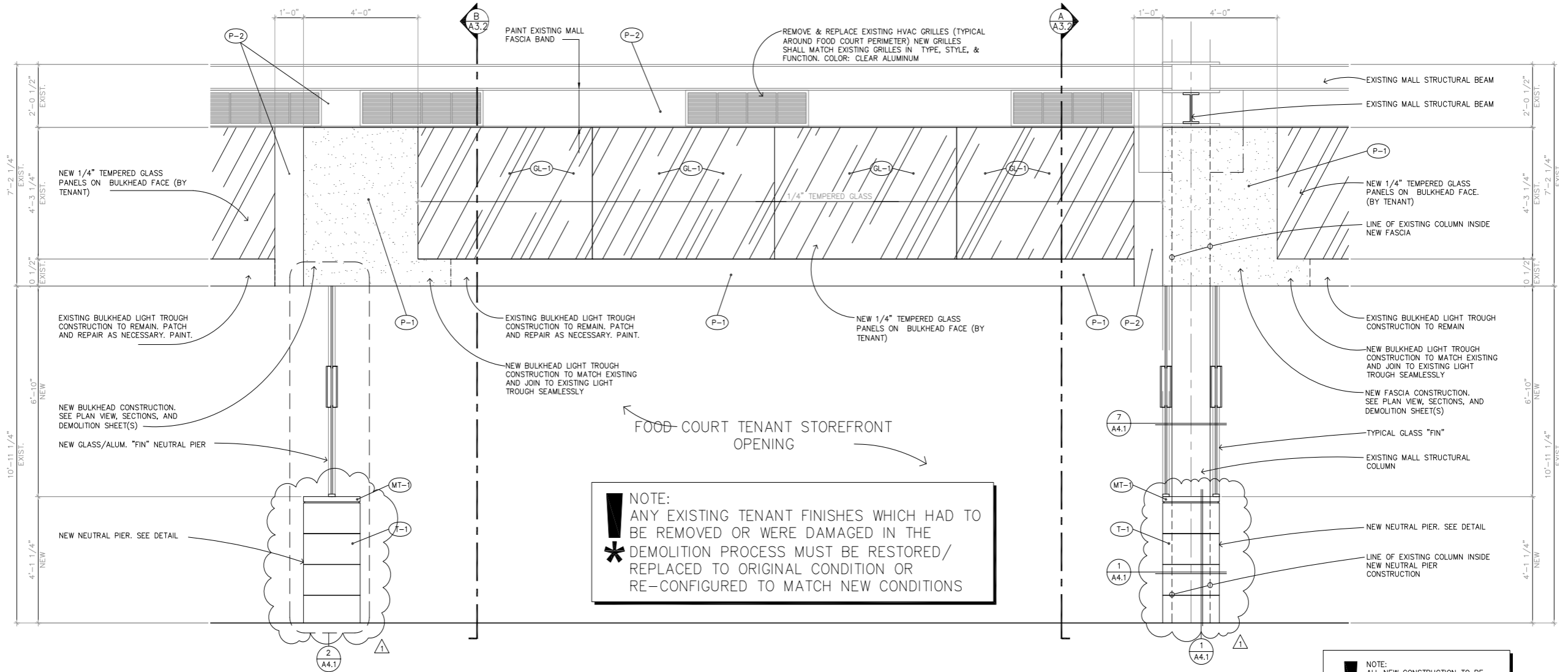

NOTE:
 ANY EXISTING TENANT FINISHES WHICH HAD TO BE REMOVED OR WERE DAMAGED IN THE DEMOLITION PROCESS MUST BE RESTORED/ REPLACED TO ORIGINAL CONDITION OR RE-CONFIGURED TO MATCH NEW CONDITIONS

NOTE:
 ALL NEW CONSTRUCTION TO BE 3-5/8" X 20ga. METAL STUD FRAMING @ 16" O.C. W/ 5/8" TYPE 'X' GYP. BD. TO MATCH EXISTING

(A) ELEVATION – NEW (TYPICAL @ EACH FOOD COURT TENANT) SCALE: 1/2" = 1'-0"

> NEW PARTIAL STOREFRONT PLAN DETAIL AND REFLECTED CEILING PLAN

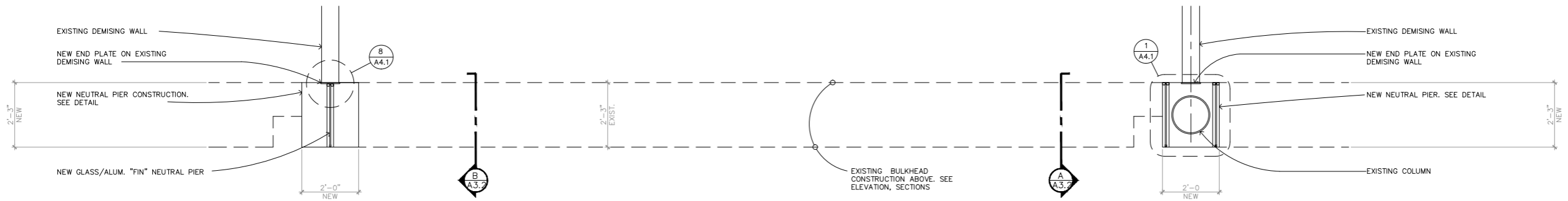

① PARTIAL FLOOR PLAN – NEW (TYPICAL @ EACH FOOD COURT TENANT) SCALE: 1/2" = 1'-0"

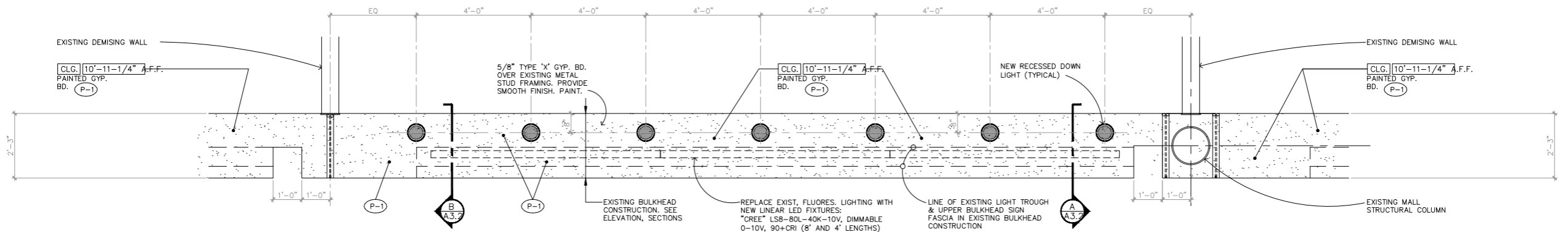

② PARTIAL REFLECTED CEILING PLAN – NEW (TYPICAL @ EACH FOOD COURT TENANT) SCALE: 1/2" = 1'-0"

> NEW TYPICAL SECTIONS

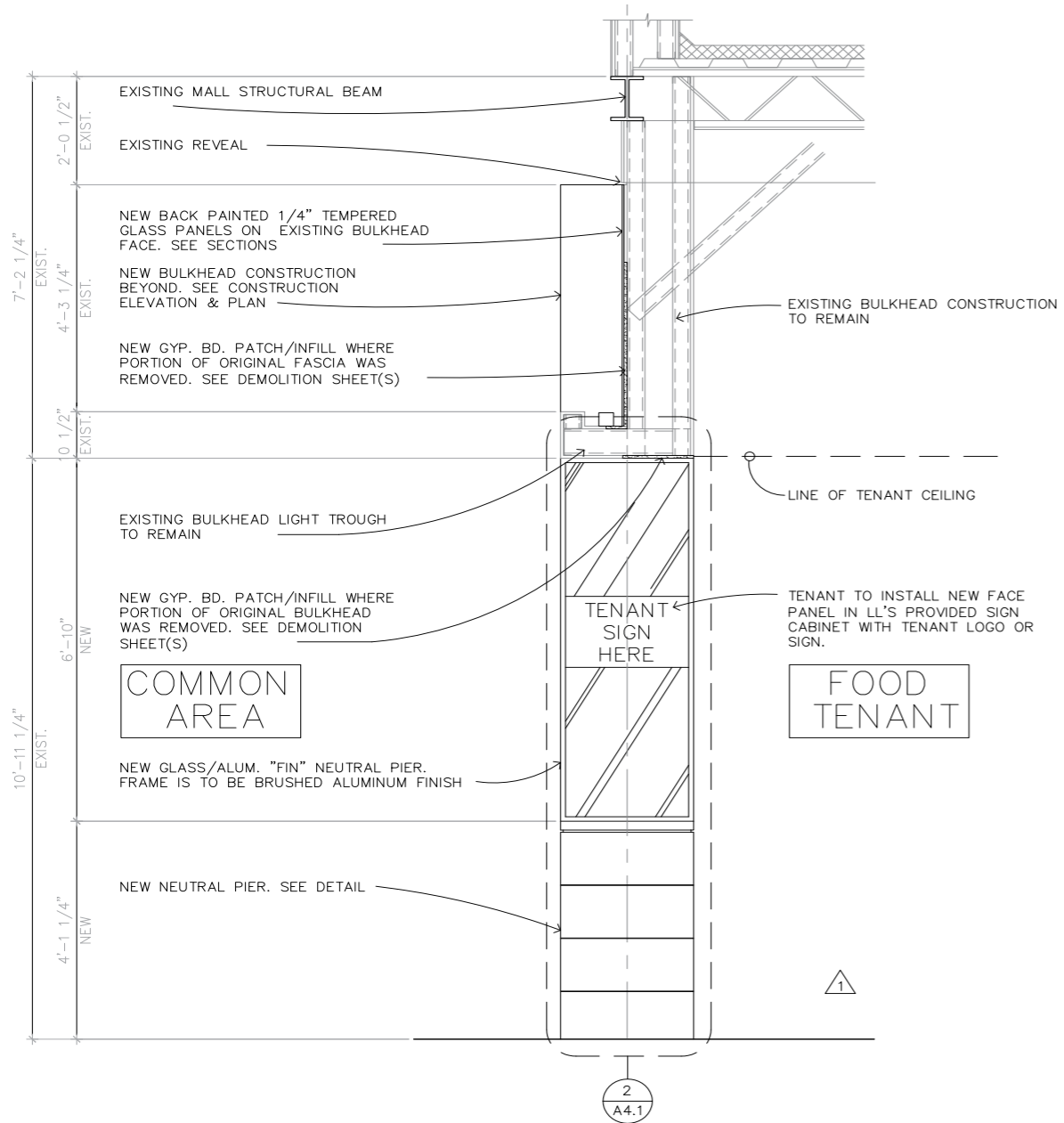

B TYPICAL SECTION — NEW

SCALE: 1/2" = 1'-0"

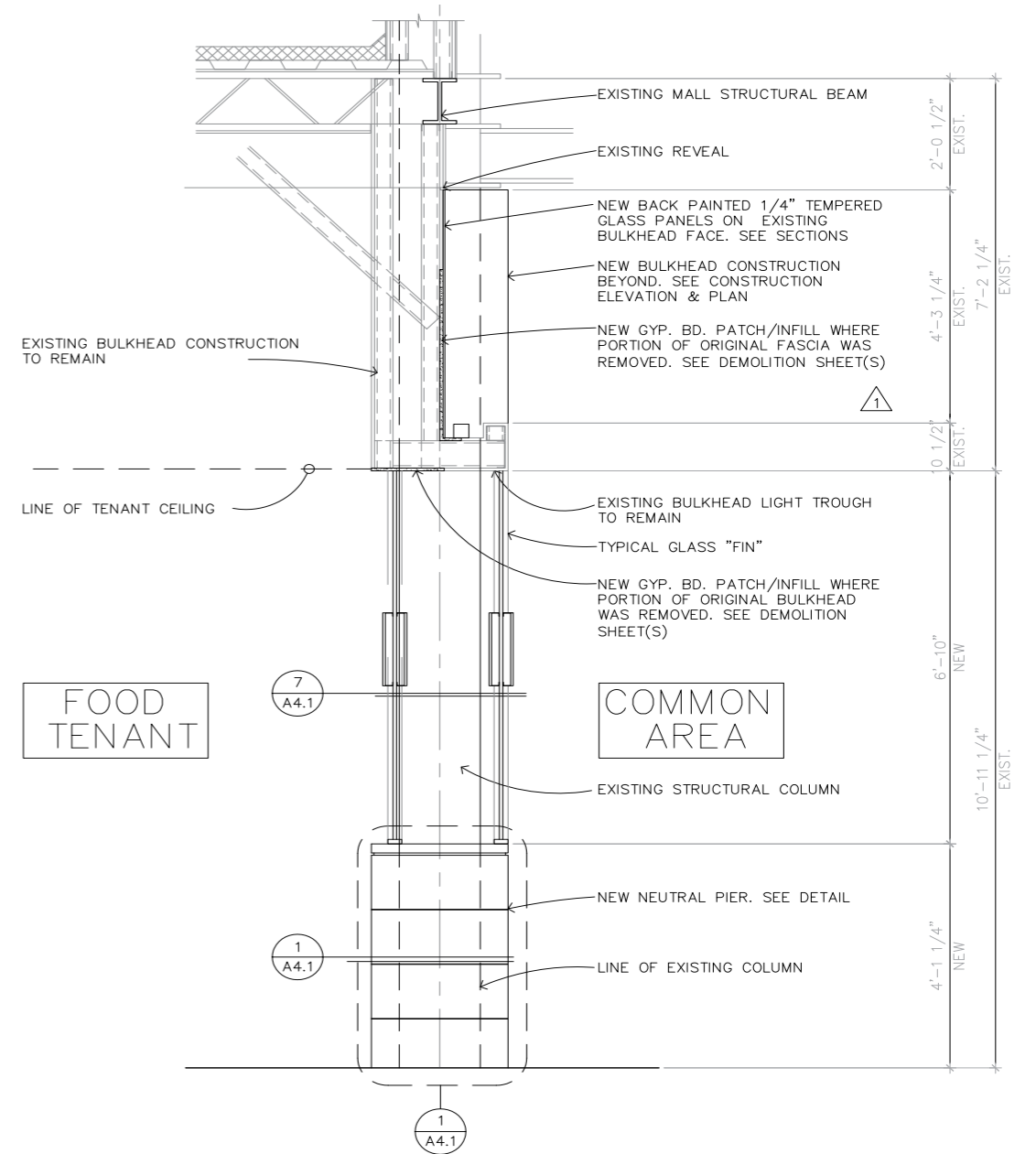

A TYPICAL SECTION — NEW

SCALE: 1/2" = 1'-0"

> REFLECTED CEILING PLAN

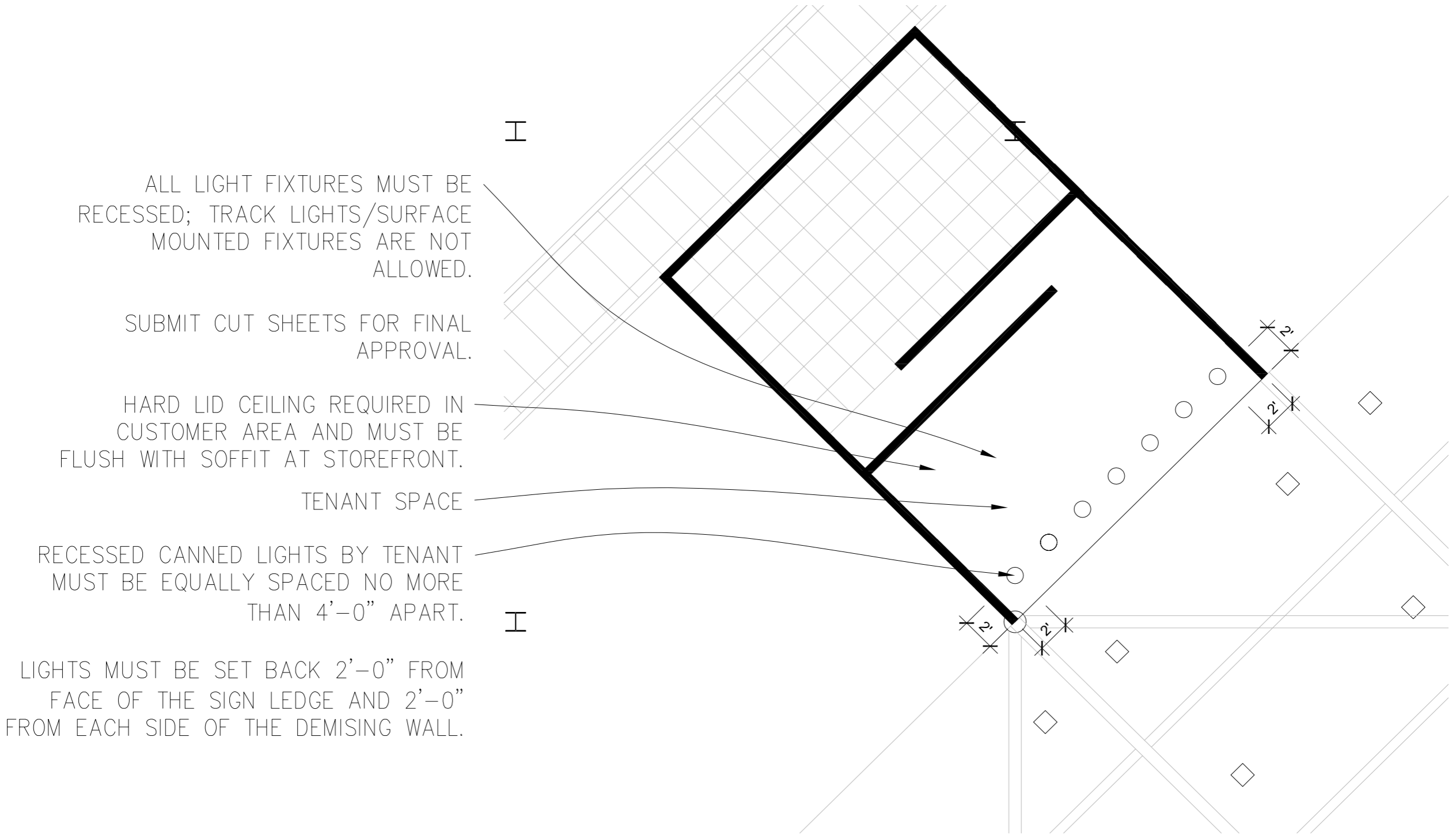

> DESIGN > STOREFRONT

OVERVIEW

Food Courts may include a variety of spaces that are comfortable and stylish, inviting the Customer to come, stay, eat, and enjoy.

The design of each unit, as viewed from the common area, must convey the unique character and sense of identity for each Tenant and also be compatible with the overall Architectural design of the Food Court.

The Storefront design area considers all portions of the Store that are visible to the public, in front of the full height service area partition.

Unique and unexpected storefront design will spark interest to draw in Customers.

Encouraged Storefront design traits include:

- Use of contrast:
 - Mixing modern and traditional design elements.
 - Mixing neutrals with colors.
 - Blending shiny and matte surfaces.
- Combining patterns with solids.
- Embracing unique craft and technology.
- Using special features, tasteful props, and displays.



> FOOD DISPLAY & PREPARATION / SEATING / QUEUING

FOOD DISPLAY

Showcases must reinforce the Tenant's image and be an integral part of the design within the counter.

Glass must be tempered or a safety type. Plexiglas is not permitted.

Showcases shall not exceed 14" above counter and 36" overall width. It shall not be more than 50% of the counter length and located no closer than 48" from the neutral pier.

FOOD PREPARATION AS THEATRE

When food preparation is visible to the public, the area is required to be designed with a sense of theater.

The need for an authentic, shared, and unique experience has grown over time. Unique experiences are the opposite of one-size-fits-all approach of the "chain". Tenants that offer a peek into the making of what they sell help include the Customer and make for an authentic experience.

SEATING

- Tenants shall typically not provide, place, or install any seating, carts, etc. inside or outside the lease premises.
- Select specific areas may include private and bistro style seating. These options are site specific, so discussing early with Leasing and Tenant Coordination is recommended. Design Approval is required for all common area Tenant seating.

QUEUE AREAS

- All food venues must provide a queue layout that allows for the Mall to maintain its code minimum distances for general circulation.
- Stanchions are not allowed. Other indicators for Customer directional flow will be considered.



> LAYOUT / SERVICE COUNTER DESIGN

LAYOUT

Due to the high visibility of the Customer Service Area, particular attention is given to the design review of this area. Service areas, furnishings, display cookery, food prep and cooking areas visible from the Mall common area must meet strict design standards.

- Support rooms and storage shall be concealed from public view.
- A full-height partition wall must separate the Customer Service Area and Prep Area.
- Access to the Prep Area shall be via a self-closing door or between staggered “blind walls”.
- Pass-thru windows with any Customer views into kitchen zone are not allowed.
- Landlord may require that any Storefront setback area shall have flooring compatible in quality, color and pattern to the Mall flooring material.
- All Tenant construction shall be self-supporting from the floor and structurally independent of the Mall fascia and bulkhead structure. Tenant construction may be braced horizontally/laterally to the overhead structure (not to the roof deck) within the Tenant space as depicted on Tenant plans and approved by the Landlord.

FRONT SERVICE COUNTER DESIGN

- The vertical counter face cannot be on one plane. Design must include areas that pop in and pop out to create movement. This can be achieved by recessing a small portion of the counter face by a few inches or can be more dramatic. This can also be achieved by ranging counter heights and taller vertical elements. Taller vertical elements must not block visibility.
- Counter face cannot be all one material. Must incorporate a minimum of two to three different types of material that coordinate well together.
- Vertical elements can include a plasma screen menu board or additional vertical signage.
- Tenant to specify a protective edge at the bottom of the counter.
- The form and materials used for counters shall be designed to be inviting to the public to help lure them to the space.
- The toe kick material must be a minimum of 3” behind the face of the counter.
- All Tenant build out must be contained within the lease line unless specifically noted in this Criteria.
- Counter tops must be “Corian” or similar solid surface materials, metal or stone. Tenant counter and counter tops are to be custom designed and fabricated.
- Plastic laminated countertops are prohibited.
- Maximum counter height is 3’-6”. Counter design, including heights, must comply with all accessibility guidelines enforced by national or local jurisdictions and the Americans with Disabilities Act.
- Sneeze guards shall be used above the front counters as required.

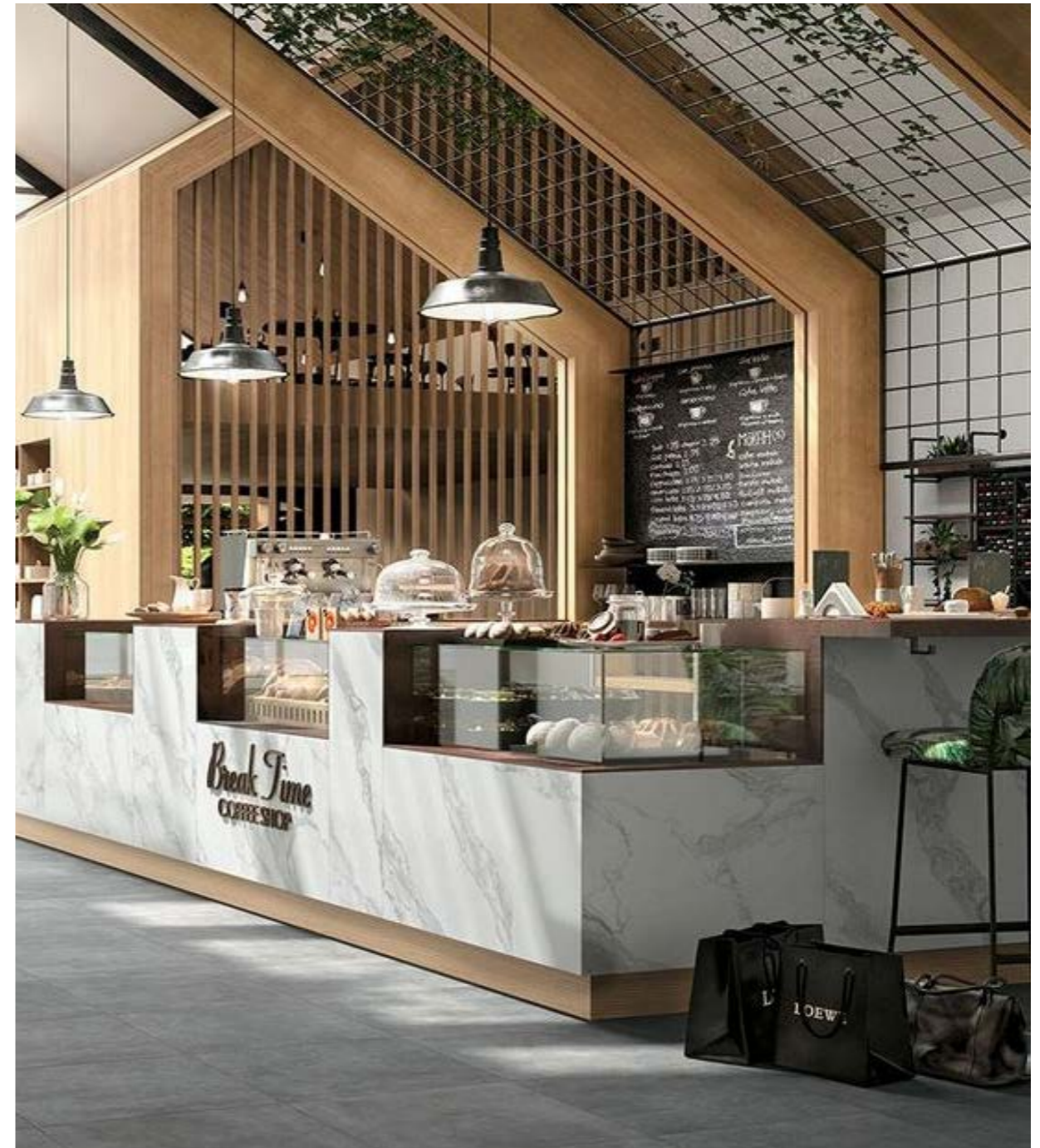

> STOREFRONT & COUNTER MATERIALS / COUNTER ELEMENTS

FRONT SERVICE COUNTER AND STOREFRONT MATERIALS

All finish materials must be backed by a minimum 5/8" solid surface material and may include the following:

- Counter tops must be solid surface materials, metal or stone. Tenant counter and counter tops are to be custom designed and fabricated.
- All stone/tile colors must be integral throughout.
- Metal panels and architectural hardware shall have a professional and durable finish.
- Color anodized, baked painted or antique finish
- Wood veneers and weathered or distressed wood (submit specification for approval)
- Resin panels such as 3-Form products
- Back-painted tempered glass panels
- Glass tiles

Finish materials shall NOT include the following materials:

- 4"x4", 6"x6", 12"x12" glazed tiles
- Shingles or boards
- Plastic laminate
- Faux or plastic formed brick, block or stone
- Clear anodized aluminum
- Other materials as deemed unacceptable by Landlord

COUNTERTOP ELEMENTS

- Cash registers must be recessed so that they extend no more than 9" above the counter top.
- Condiment and utensil displays or dispensers must be fully recessed into the counter.
- Fully recessed counter-top trash receptacles (for straw wrappers, etc.) must be provided near the condiment and utensil displays.
- Tray rails, if used shall be integrated into the counter design and be contained within the lease line.
- Drink dispenser and other utilitarian kitchen equipment may not be placed on the front counter.
- Employee access through the counter front is not permitted. Back counters visible to the public must be built in units with a recessed base detail.



> LIGHTING

LIGHTING

Tenants must light both their Storefront as well as the countertop.

Lighting on architectural elements and menu boards are also required.

- Recessed down lighting must be provided at all gypsum board ceilings visible to customers. BK Lighting MC-48-xxx-9-11-B or approved equal by Lumiere. Lamps are to be 50 PAR 20/H/SP.
- Down lighting or pendant lighting is required at the front counter to provide a more intimate and decorative atmosphere while highlighting the counter top and merchandise presentation. Fixtures to be supplied and installed by Tenant to Landlord specifications. Other track lighting may be considered provided that it is not visible from the public area.
- Fluorescent lights are prohibited in all areas visible to the public. They are however, permitted in areas not visible to the public.



> STOREFRONT CEILING / GRILLE / NEUTRAL PIERS & WALLS

STOREFRONT CEILING

- Suspended ceiling of gypsum board (hard lid) is required in Customer areas. See specific zone area for additional requirements.
- Tenant must provide a reflected ceiling plan indicating any and all Tenant lighting, suspended design elements and signage for Landlord approval.
- Ceiling access panels, where required must be depicted on the Tenant's plans, approved by Landlord and be provided at Tenant's expense.
- Allow for access to all structural mechanical, plumbing, electrical, telephone and fire protection systems including all junction boxes, switches, valves, etc. and other equipment for purposes of servicing, and maintaining this infrastructure.

ROLLING GRILLES

Rolling grilles are not allowed.

NEUTRAL PIERS AND DEMISING WALLS

The Customer Service Area shall address the full opening width, abutting the Neutral Walls and Neutral Knee Walls on each side of the leased space and extending full height to the Mall soffit.

- Mall structural columns, excluding those treated as neutral piers, located either within the Storefront Zone or along the store frontage, must be integrated into the store design unless otherwise directed by Landlord.
- Special condition neutral walls may be low and extend back from the face of the lease line. This condition increases visibility into the store, however, it requires close coordination with the Tenant Coordinator in the design process.



> INTERIOR AND PREP AREA

Kitchen areas, storage, dish areas, and any other areas not visible to the public must meet the following design requirements:

LIGHTING

Lighting may include, but is not limited to:

- 2' x 4' lay-in surface-mounted fluorescent light fixtures.
- Any fixture allowed by code necessary for food preparation.

FLOORING

The entire Lease Premises shall be completely and properly sealed using a 'Dex-o-tex' NEOBOND II Fracture Resistant Membrane Waterproofing or equal membrane type sealer approved by Landlord, prior to the installation of any finished flooring material.

The membrane must be turned up all perimeter Storefront walls, counters and surfaces a minimum of 24", to protect the adjacent Tenants and Mall common areas. Then, either FRP (prep area only), or tile is to be installed up to at least 4'.

Tenant to submit detail to Landlord for approval prior to installation.

Tenant shall furnish and install floor tile over waterproof membrane throughout the entire premises.

The finished floor must be sloped to the Tenant installed floor drains.

Allowed flooring materials include:

- Quarry tile
- Porcelain ceramic tile

Prohibited flooring materials include:

- Vinyl
- Glazed ceramic tile
- Carpet
- Any other material deemed unsuitable by the Landlord

CEILING

2' x 4' drop-in panels with an approved finish shall be permitted in storage areas so long as they are not visible to the customers.

WALLS

All walls in the Prep Area must be of a durable, non-porous, washable surface as required by health codes.

EXIT DOORS

All exit door specifications, hardware, door handles, recess dimensions, etc. shall be per Landlord Criteria and conform to local codes and ordinances.



> SIGNAGE > STOREFRONT

Food Court Tenant's primary Storefront sign must be creative, imaginative and incorporated into the overall Storefront design.

- Sign must be proportional to overall elevation. Landlord will review sign size on an individual basis. Sign length must not be more than 1/3 of the overall storefront length.
- Sign must complement overall design and add visual interest.
- Sign must be mounted on the sign shelf as shown in the [ZONE PLAN](#).
- Power must be concealed.
- 12" max letter height will be enforced.
- Back of sign must be finished.

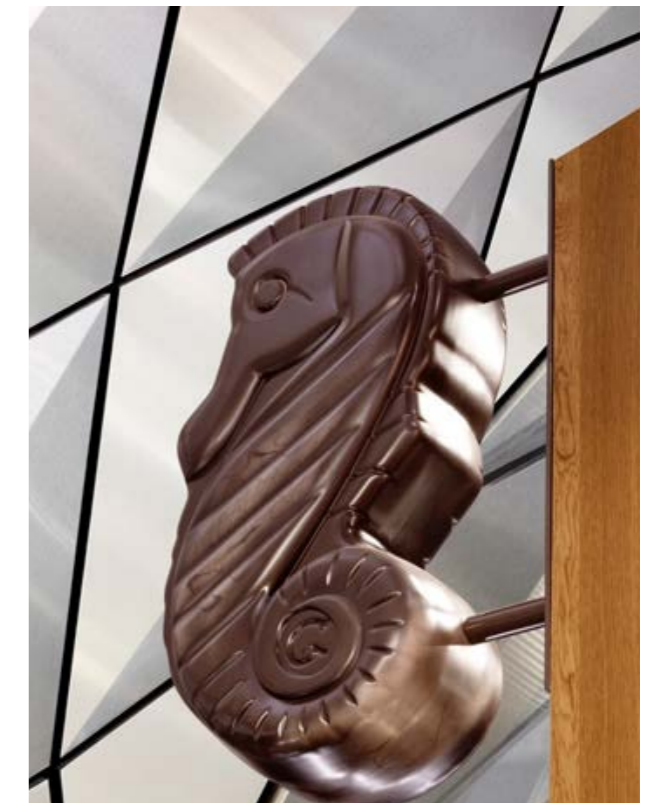

> MENU BOARDS

Menu board applications must be a part of the overall store design. We strongly encourage using a graphic designer to create your boards.

DESIGN REQUIREMENTS

The following requirements must be used when designing your menu boards:

- All menu boards must be submitted to the Landlord for review and approval prior to start of Tenant construction.
- Professional quality drawings/renderings must be submitted for approval.
- Design shall be an integral part of the graphics and complimentary to primary signage character.
- Overall width of menu board cannot exceed 60% of overall Storefront width.
- Mounting height to be a minimum of 7'-0" to bottom of sign with maximum height of 10'-0" and held a minimum of 10" from edge of walls.
- The menu board must be non-reflective to avoid glare.

PERMITTED ELEMENTS

Permitted menu board design elements include:

- Artisan type quality such as chalkboards, painted wood or unusual materials and combinations of material.
- Frames, holders, text, photo displays, lighting and materials must be creatively designed.
- High quality digital printouts for menu board may be approved at Landlord's discretion.
 - Photographs used in menu boards must be professionally produced and approved by the Landlord.
 - Plasma screens cannot be surface mounted.
- Externally illuminated menu boards are allowed.
 - Tenant is required to submit light fixture cut sheet for approval.

PROHIBITED ELEMENTS

Not permitted menu board design elements include:

- Standard factory designs.
- Standard surface-mounted box-type internally illuminated menu boards are not permitted.



> TECHNICAL

Food Court Tenants must adhere to the technical requirements found in the [INLINE TECHNICAL CRITERIA](#).

In addition to the requirements detailed in the Technical Criteria, Tenants cooking food in their space must adhere to the following:

GENERAL REQUIREMENTS

- **KITCHEN SINKS** including pot sinks, scullery sinks, pre-wash sinks and other kitchen units must be connected to a grease trap.
- **DISHWASHERS** may not be connected to grease trap.
- **GREASE INTERCEPTOR** must be designed and approved by Landlord prior to installation, especially if located outside the lease line.
- **OIL COLLECTION AND HAULING SYSTEM** is required for Tenants with fryers or other grease/oil generating equipment that does not run through an interceptor. Landlord does not provide a centralized collection point.
- **BACKFLOW PREVENTERS** are required for food service, hair salons or other Tenants with equipment or operations that have the possibility of backflow. These must be certified and acceptable to the water district and checked yearly or as required by the local authority having jurisdiction.

KITCHEN EXHAUST REQUIREMENTS

- **LANDLORD REVIEW** is required to ensure the exhaust does not compromise the ventilation air of adjacent mall roof top units.
- **GREASE EXHAUST** must be provided on all exhaust blowers. Supreme Heavy Duty GBD Exhaust Blowers are required for all kitchen exhaust or grease laden air removal.

FUMES AND ODORS

The following constitutes the minimum requirements for special exhaust systems which Tenant must furnish and install in the Leased Premises for the elimination of fumes and odors due to Tenant operations:

- A separate exhaust system must be provided and installed which will generate negative pressure in the Leased Premises as outlined below.
- A total negative pressure of between five and ten percent (5-10%) must be maintained during all hours that Tenant is operating its business in the Leased Premises.
- The HVAC system must be modified to provide additional make-up supply air to offset the quantity of air exhausted.
- The Tenant must have an AABC certified air balancing contractor test the completed system and verify its operation according to these specifications. A copy of the air balancing report must be submitted to the Mall General Manager for review and approval prior to opening for business.
- The combined HVAC and exhaust system per the above-noted specifications must be in operation during all hours that Tenant is operating its business in the Leased Premises.
- The combined HVAC system must be connected to the Landlord EMS by the Landlord required contractor. See the Technical Criteria section for specifics.
- Indoor tenants which will be using any type of gas, liquid or solid fuel for heating, cooking or other use, must have an active carbon monoxide detector installed. The type should be and Hardwire Interconnectable 120- Volt Carbon Monoxide Alarm with Digital Display and Battery Backup.
- Carbon dioxide detection is required if tenant has a carbon dioxide systems with 100 lbs. or more of carbon dioxide used in their beverage dispensing applications.

STRUCTURAL

The structure or sub-structure that supports any new or replacement HVAC unit, transformer, other heavy equipment or modification of any structure or substructure, shall be designed, engineered and installed at Tenant's sole cost and expense.

Tenant shall provide structural engineering calculations and drawings from a licensed structural engineer (Registered in the State of the Center where the work is located) to Landlord for review and approval prior to installation of any such items or equipment.

All equipment is to be installed over structural members that can support the weight of the equipment in areas designated by Landlord.

All recommendations of design and verification of completion shall include the structural engineer's embossed seal from the state.

ELECTRICAL

An empty, separate meter socket will be stubbed to the Tenant premises from the Mall electrical room. Tenant must install a demand check meter per Landlord specs using the Landlord required contractor. See the Technical Criteria section for specifics.

NATURAL GAS

All new development and newly tenanted restaurants need to have seismic gas shut-off valves installed on Landlord side of the meter, at each individual space.

Seismic valves must be:

- UL-approved, FM-approved or, ACSE 25-compliant.
- All devices must be installed consistent with manufacturer's instructions and following jurisdictional code.

Natural Gas service is available for Tenants to obtain. Tenants will be responsible for obtaining gas service from the gas company. Gas is permitted for cooking equipment only, not for HVAC.

POTABLE WATER

A single water stub-in will be supplied by the Landlord from the Landlord's meter to each Tenant space. Tenant shall provide a water sub-meter that is accessible to Mall management.

SANITARY WASTE

A 4" sanitary waste line shall be stubbed below each Tenant space by Landlord. Tenant shall route their own vent lines to a point above the roof.

GREASE WASTE

Tenant shall route their own vent lines to a point above the roof. Tenant must provide their own grease interceptors.

FIRE PROTECTION / SPRINKLER SYSTEM

Tenants must use the Mall's required sprinkler contractor as well as connect to the Landlord's fire alarm system, using the Landlord required fire alarm contractor.

INLINE COUNTER SERVICE > CONTENTS

❑ DESIGN

- ❑ *PREP & FOOD DISPLAY / LAYOUT*
- ❑ *QUEUE / PATIOS / SEATING*
- ❑ *COUNTER DESIGN / COUNTER ELEMENTS*
- ❑ *MATERIALS / LIGHTING / FLOORING*

❑ SIGNAGE

- ❑ *PRIMARY SIGNAGE / MENU BOARDS*

❑ TECHNICAL

SECTIONS OF INTEREST

- ❑ *INLINE CRITERIA*
Includes standard design, technical, and sign requirements in addition to the contents in this section.
- ❑ *DESIGN INSPIRATION*
Provides design inspirations for visual aesthetics.
- ❑ *BUILDING DETAILS*
Includes property reference photos and specific storefront design details.
- ❑ *PROPERTY INFO*
Includes information on the Property's building codes, area permitting, and required contractors.
- ❑ *SUBMITTALS*
Outlines requirements on how and what to compile for submittals to the Landlord for design reviews.

The Inline Food Counter Service Criteria provides key technical information and design requirements to ensure your common area facing counter food service enlivens the consumer experience and interfaces with the Center.

This criteria will often point to the [INLINE RETAIL CRITERIA](#) as several requirements and design concepts are shared. The content in this section highlights the unique concepts for food service design.

The tenant and the tenant's architect assume the following important obligations:

- Fulfill the intent of the Criteria both in concept and in detail.
- Determine and respond to the actual physical conditions of the Tenant's location.
- Maintain and enhance the high standards of quality established in the construction of the Center.
- Ensure the quality of execution of all design material, finish, and detail concepts in the construction of the Tenant's improvement.
- Provide the required detail at all transitions from Tenant storefront to neighboring storefronts, as well as to the base building.



> DESIGN > PREP & FOOD DISPLAY / LAYOUT

Inline and Restaurant Food Tenants must adhere to the design requirements found in the [INLINE RETAIL DESIGN CRITERIA](#).

In addition to the requirements detailed in the Design Criteria, Tenants serving food in their space must adhere to the following design requirements:

PREPARATION AS THEATER

Tenant's offering a peek into the making of food, by nature, include the Customer and make for an authentic experience. This inclusion of the Customer will increase engagement and is highly encouraged.

FOOD DISPLAY

When displaying food, the following requirements must be followed:

- Showcases must reinforce the Tenant's image and be an integral part of the design within the counter.
- Glass must be tempered or a safety type. Plexiglas is not permitted.
- Showcases shall not exceed 14" above counter and 36" overall width. It shall not be more than 50% of the counter length and located no closer than 48" from the neutral pier.

LAYOUT

Due to the high visibility of the Customer Service Area particular attention is given to the design review of this area. Service areas, furnishings, display cookery, food prep and cooking areas visible from the mall common area must meet strict design standards.

- Support rooms and storage shall be concealed from public view.
- A full-height partition wall must separate the Customer Service Area and Prep Area.
- Access to the Prep Area shall be via a self-closing door or between staggered "blind walls".



> DESIGN > QUEUE / PATIOS / SEATING

QUEUE AREAS

All food venues must provide a queue layout that allows for the Mall to maintain its code minimum distances for general circulation.

Stanchions are not allowed. Other indicators for customer directional flow will be considered.

PATIO AREAS

Exposed patios are encouraged however, they should not extend beyond the lease line. In special cases there may be opportunity to extend the patio but it must be in compliance with all common mall code, circulation requirements, and leasing agreements.

Projection or canopy may increase the visibility of the storefront over seating areas. They also help with lighting the Storefront.

- Common mall flooring must be maintained. Coordinate with Landlord design if railings or other elements will have an effect on the flooring.

SEATING

Where interior seating is needed or desired, it is suggested that the enclosure line be moved into the lease space by approximately 12 feet.

- Patio seating must be separated from the common area circulation in the Mall. A layout will be required.
- All visible furniture must be reviewed by the Landlord for suitability both aesthetically, as well as for performance specifications.
- Tenant is responsible to confirm additional requirements with the local authorities for any railing or barrier for the Tenant's proposed area.
- In some cases options for furniture may be supplied by the mall design team for the Tenant to choose from.



> COUNTER DESIGN / COUNTER ELEMENTS

FRONT SERVICE COUNTER DESIGN

- The form and materials used for counters shall be designed to be inviting to the public to help lure them to the space.
- Tenant to specify a protective edge at the bottom of the counter.
- Counter tops must be “Corian” or similar solid surface materials, metal or stone. Tenant counter and counter tops are to be custom designed and fabricated.
- Plastic laminated countertops are prohibited.
- Maximum counter height is 3’-6”. Counter design, including heights, must comply with all accessibility guidelines enforced by national or local jurisdictions and the Americans with Disabilities Act.
- Sneeze guards shall be used above the front counters as required.

COUNTERTOP ELEMENTS

- Cash registers must be recessed so that they extend no more than 9” above the counter top.
- Condiment and utensil displays or dispensers must be fully recessed into the counter.
- Fully recessed counter-top trash receptacles (for straw wrappers, etc.) must be provided near the condiment and utensil displays.
- Drink dispenser and other utilitarian kitchen equipment may not be placed on the front counter.



> MATERIALS / LIGHTING / FLOORING

FRONT SERVICE COUNTER AND STOREFRONT MATERIALS

All finish materials must be backed by a minimum 5/8" solid surface material and may include the following:

- Countertops must be solid surface materials, metal or stone. Tenant counter and counter tops are to be custom designed and fabricated.
- All stone/tile colors must be integral throughout.
- Metal panels and architectural hardware shall have a professional and durable finish.
- Color anodized, baked painted or antique finish
- Wood veneers and weathered or distressed wood (submit specification for approval)
- Resin panels such as 3-Form products
- Back-painted tempered glass panels
- Glass tiles

Finish materials shall NOT include the following materials:

- 4"x4", 6"x6", 12"x12" tiles
- Shingles or boards
- Plastic laminate
- Faux or plastic formed brick, block or stone
- Clear anodized aluminum
- Other materials as deemed unacceptable by Landlord.

LIGHTING

Tenants must light both their Storefront as well as the countertop. Lighting on architectural elements and menu boards are required.

FLOORING

All "wet" areas must install a waterproof membrane that is tested and confirmed by the Landlord. Full requirements can be found in the plumbing section of the [INLINE TECHNICAL CRITERIA](#).



> SIGNAGE > PRIMARY / MENU BOARDS

PRIMARY STOREFRONT SIGN

Inline and Restaurant Food Tenants must adhere to the signage requirements found in the [INLINE SIGN CRITERIA](#).

MENU BOARDS

Inline and Restaurant Food Tenants must adhere to the menu board requirements found in the [FOOD COURT SIGN CRITERIA](#).

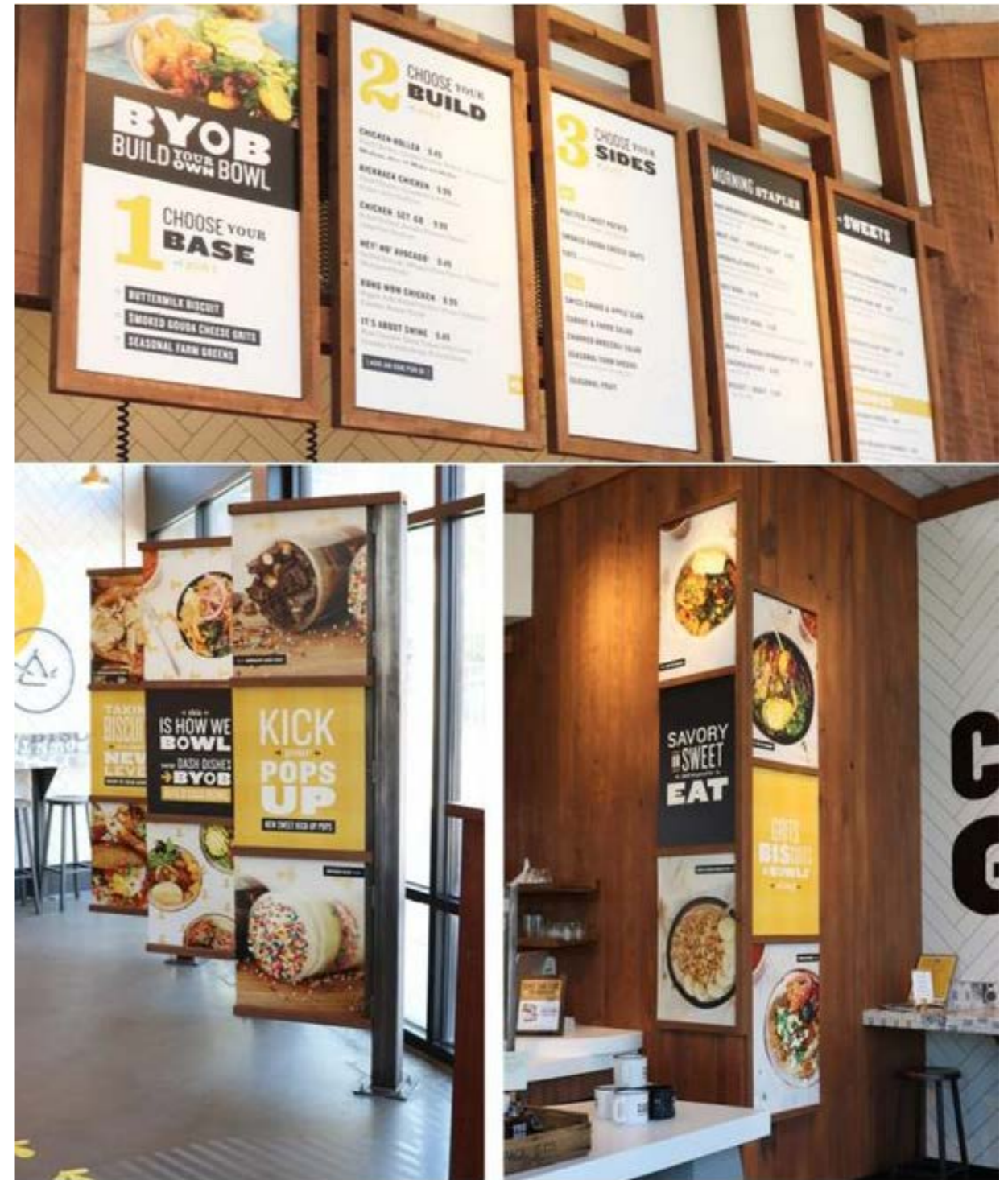

> TECHNICAL

Inline and Restaurant Food Tenants must adhere to the technical requirements found in the [INLINE TECHNICAL CRITERIA](#).

In addition to the requirements detailed in the Technical Criteria, Tenants cooking food in their space must adhere to the following:

GENERAL REQUIREMENTS

KITCHEN SINKS including pot sinks, scullery sinks, pre-wash sinks and other kitchen units must be connected to a grease trap.

DISHWASHERS may not be connected to grease trap.

GREASE INTERCEPTOR must be designed and approved by Landlord prior to installation, especially if located outside the lease line.

OIL COLLECTION AND HAULING SYSTEM is required for Tenants with fryers or other grease/oil generating equipment that does not run through an interceptor. Landlord does not provide a centralized collection point.

BACKFLOW PREVENTERS are required for food service, hair salons or other Tenants with equipment or operations that have the possibility of backflow. These must be certified and acceptable to the water district and checked yearly or as required by the local authority having jurisdiction.

KITCHEN EXHAUST REQUIREMENTS

LANDLORD REVIEW is required to ensure the exhaust does not compromise the ventilation air of adjacent mall roof top units.

EXHAUST FAN must be a SWSI centrifugal fan which must be fitted with a minimum 10'-0" stainless steel upblast. Guy wires must be attached to the roof in order to secure the stack. Use the mall roofer for connection of the guy wires at Tenant's expense.

GREASE GUARD CONTAINMENT SYSTEM (or approved equal) must be installed to protect the Landlord's roof. A quarterly maintenance program must be in-place for the grease containment units. Proof of the maintenance contract must be presented to Operations Manager prior to the store opening.

RESTAURANT SPECIFIC REQUIREMENTS

PLANS MUST SHOW sizes and locations for all duct and piping through roof as well as all required fireproofing.

CONTAIN ALL GARBAGE AND REFUSE AREAS WASH DOWN "grey" water and properly drain off into city approved system (i.e. sewer or storm).

FOOD PREP AND BAKING ON SITE REQUIREMENTS

INSTALL DRY CHEMICAL EXTINGUISHING DEVICES (such as Ansul) approved by the fire insurance rating organization carriers.

MAINTAIN ALL EXHAUST DUCTS AND FILTERS in a clean condition. Ducts are to be professionally cleaned on a regular basis to help prevent grease fires.

GARBAGE AND REFUSE MUST BE PLACED IN CONTAINERS which shall be kept, until collected, in a self-contained area within the demised premises set aside for the storage of garbage and/or storing of inflammable or combustible materials. Tenant agrees to install and maintain appropriate chemical extinguishing devices.

FAILURE TO INSTALL REQUIRED EQUIPMENT referred to in this section and/or to subscribe to the servicing thereof, Landlord shall have the right to enter the demised premises and to make any necessary installations and charge the cost of such installations and/or the servicing thereof to Tenant which Tenant agrees to pay to Landlord, as additional rent, within ten (10) days after demand.

GAS UTILITY

Gas may be available at the Center for cooking applications. If available, Tenant, at its sole cost and expense and in compliance with local code must procure gas service to and within the demised premises and will make all necessary arrangements with the local Gas Company for such service.

SERVICE REQUIREMENTS

GAS METER INSTALLATION at gas meter header is the responsibility of the Tenant.

GAS PIPING INSTALLATION, when allowed, is the responsibility of the Tenant to provide and install. Roof piping must be placed on pillow blocks or similar arrangement. All roof repairs to be by the Landlord's required roofer at Tenant's expense.

PRESSURE REGULATORS required for connection to Tenant's equipment is the responsibility of the Tenant. Coordinate with Landlord for regulator vent routing.

SEISMIC AND MANUAL SHUTOFF DEVICES are required for the entire gas piping system. Equipment or fixtures must be color coded or identified as required. Seismic valves must be: UL- approved; FM-approved; or, ACSE 25-compliant. All new development and newly tenanted restaurants need to have seismic gas shut-off valves installed on Landlord side of the meter, at each individual space.

RESTAURANTS > CONTENTS

- DESIGN**
 - STOREFRONT / PREPARATION AS THEATER*
 - CONTROL AREAS / SEATING*
 - EXTERIOR*

- SIGNAGE**
 - STOREFRONT / MENU BOARDS*

- TECHNICAL**

SECTIONS OF INTEREST

- INLINE CRITERIA**

Includes standard design, technical, and sign requirements in addition to the contents in this section.
- DESIGN INSPIRATION**

Provides design inspirations for visual aesthetics.
- BUILDING DETAILS**

Includes Property reference photos and specific Storefront design details.
- PROPERTY INFO**

Includes information on the Property's building codes, area permitting, and required contractors.
- SUBMITTALS**

Outlines requirements on how and what to compile for submittals to the Landlord for design reviews.

The Restaurant Criteria provides key technical information and design requirements to ensure your interior or exterior facing restaurant food service enlivens the consumer experience and interfaces with the Center.

This Criteria will often point to the [INLINE RETAIL CRITERIA](#) as several requirements and design concepts are shared. The content in this section highlights the unique concepts for food service design.

The Tenant and the Tenant's architect assume the following important obligations:

- Fulfill the intent of the Criteria both in concept and in detail.
- Determine and respond to the actual physical conditions of the Tenant's location.
- Maintain and enhance the high standards of quality established in the construction of the Center.
- Ensure the quality of execution of all design material, finish, and detail concepts in the construction of the Tenant's improvement.
- Provide the required detail at all transitions from Tenant Storefront to neighboring Storefronts, as well as to the base building.



> DESIGN > STOREFRONT / PREPARATION AS THEATER

Restaurant Food Tenants must adhere to the design requirements found in the [INLINE DESIGN CRITERIA](#).

In addition, Tenants serving food in their space must also adhere to the following:

GENERAL STOREFRONT AND DESIGN

We encourage a cohesive presentation of the brand within the context of the whole Mall design, while the individual brand is important and the two must harmonize. Design should be tailored to its location both within the community and the whole Center's aesthetics.

Restaurants may face both the interior and the exterior, and are often located adjacent to a Mall entry. The exterior and the interior are subject to different Criteria standards, both for presentation and signage.

Interior restaurants oftentimes have a waiting area within the common space.

- If needed these must be shown in the submissions and be approved by Landlord. They must be coordinated with common area needs and code requirements.

PREPARATION AS THEATER

Tenant's offering a peek into the making of food, by nature, include the Customer and make for an authentic experience. This inclusion of the Customer will increase engagement and is highly encouraged.



> CONTROL AREAS / SEATING

CONTROL AREAS

The DCA is the area at the front of the Tenant space that extends from the lease line to all points 6'-0" into the space. It should convey excitement and give the consumer a reason to engage.

Exposed patios are encouraged however, they should not extend beyond the lease line. In special cases there may be opportunity to extend the patio but it must be in compliance with all common Mall code and circulation requirements.

Projection or canopies may increase the visibility of the Storefront over seating areas. They also help with lighting the Storefront.

In addition to the general DCA Criteria for inline stores the following requirements must be met:

- All patio rails, reception podiums, waiting areas, menu presentations, lighting, heating, visible banquet detailing, and material palates must be presented for review and approval.
- Common Mall flooring must be maintained. Coordinate with Landlord design if railings or other elements will have an effect on the flooring.

SEATING

Where interior seating is needed or desired, it is suggested that the enclosure line be moved into the lease space by approximately twelve (12') feet.

Seating design requirements include:

- Patio seating must be separated from the common area circulation in the Mall by a low barrier. A layout will be required for review.
- All visible furniture must be reviewed by the Landlord for suitability both aesthetically, as well as for performance specifications.
- Tenant is responsible to confirm additional requirements with the local authorities for any railing or barrier for the Tenant's proposed area.



> EXTERIOR

Restaurants with exterior Storefronts will be subject to the general Criteria in this manual, for aesthetics.

Exterior design should be tailored to its location both within the community as well as the whole Mall and its aesthetics.

SITE PLANS

- A Site Plan must be submitted that includes all required calculations for GLA, GBA, and parking requirements.
- Site Circulation must be included showing the adjacent intersections, driveways, drive directions, and dimensions of all access points.
- Photos of adjacent and onsite conditions may be required by Ownership for the review process.

AMENITIES

- Planters, heat lamps, tables, chairs etc., must be submitted for approval. All amenities must be commercial grade and suitable for outdoor use.
- Pendant or sconce lighting must be submitted for approval by Landlord.
 - Lighting plans of canopies and trellis are available in Landlord supplied base drawings.
- Umbrellas are only allowed in the designated areas and cannot overhang into the public right-of-way.
 - Umbrellas should be small in scale (maximum 6'-0" in diameter) and no more than 9'-0" high at the peak.
 - Wood or metal are the only acceptable materials for the umbrella structure. No insignia, graphics or text are permitted on the umbrella fabric.
 - The umbrella fabric must be flame retardant material in a color approved by Landlord's Tenant Coordinator.

EXTERIOR PATIOS

- Any changes to an existing patio must be approved by Landlord. Tenant is responsible to confirm the requirements with the local municipality for proposed use.
- Temporary elements such as greeting stands, or waiting areas must be submitted for review.
- Confirm code height and density of railings for any necessary barriers.
- Patio layouts with adjacent circulation dimensions must be included in the first submittal of documents for design review.
- Railing design details should be submitted with the concept and construction packages for approval by the Landlord design team.



> SIGNAGE > PRIMARY / MENU BOARDS

PRIMARY STOREFRONT SIGN

Inline and Restaurant Food Tenants must adhere to the Signage requirements found in the [INLINE SIGN CRITERIA](#).

Exterior signage must adhere to the requirements established by the local municipality.

MENU BOARDS

Inline and Restaurant Food Tenants must adhere to the menu board requirements found in the [FOOD COURT SIGN CRITERIA](#).





> TECHNICAL

Inline and Restaurant Food Tenants must adhere to the technical requirements found in the [INLINE TECHNICAL CRITERIA](#).

In addition to the requirements detailed in the Technical Criteria, Tenants cooking food in their space must adhere to the same requirements found in the [INLINE FOOD TECHNICAL CRITERIA](#).

KIOSK CRITERIA CONTENT OVERVIEW

3.1

DESIGN INSPIRATION

PROVIDES DESIGN INSPIRATIONS AS TO WHAT KIND OF KIOSK DESIGNS CAN BE PRODUCED.

3.2

DESIGN ELEMENTS AND REQUIREMENTS

DETAILS DESIGN CONCEPTS AND REQUIREMENTS TO INCORPORATE INTO THE OVERALL KIOSK DESIGN.

3.3

FOOD DESIGN ELEMENTS AND REQUIREMENTS

DETAILS SPECIFIC DESIGN ELEMENTS AND REQUIREMENTS FOR KIOSKS SELLING AND COOKING FOOD.

3.4

TECHNICAL

DETAILS THE TECHNICAL DESIGN REQUIREMENTS TO INSURE THE KIOSK INSTALLATION INTERFACES WITH THE UTILITIES AT THE CENTER.

3.5

PROCESS

PROVIDES AN OVERVIEW OF THE DESIGN, CONSTRUCTION, AND INSTALLATION OF KIOSKS.

3.6

DESIGN DETAILS

SPECIFIC DESIGN DETAILS REQUIRED TO BE ADOPTED AND SHOWN IN THE KIOSK DESIGN SUBMITTAL DRAWINGS.

SECTIONS OF INTEREST

- DESIGN INSPIRATION**
Provides visual inspirations for design aesthetics.
- PROPERTY INFO**
Includes information on the Property's building codes, area permitting, and required contractors.
- SUBMITTALS**
Outlines the requirements on how and what to compile for submittals to the Landlord for design reviews.

Macerich strives to differentiate its shopping environment through fresh, innovative design and unique retail offerings. We transform everyday shopping into a truly unexpected and exhilarating experience.

Innovative design has proven to stimulate customer interest which in turn drives sales. For Macerich and kiosk Tenants to achieve this goal, we ask our tenants to fabricate a high quality, experiential retail design that is cohesive and complimentary to the overall shopping center environment.



DESIGN INSPIRATION > CONTENTS

- URBAN
- ARTISAN
- WHIMSICAL
- INVITING
- ARTSY
- THEATRICAL

SECTIONS OF INTEREST

The following sections provide additional details and requirements related to this Criteria:

- DESIGN INSPIRATION*
Provides additional visual inspirations for design aesthetics.

GET INSPIRED!

The following inspirations are intended to help you visualize what kind of kiosk design can be produced. These aesthetic examples encourage bold design to draw Customers and enliven the common area visuals of the Center. By the nature of their prominent locations, kiosks require great design and an attention to detail to ensure high quality retail experiences.

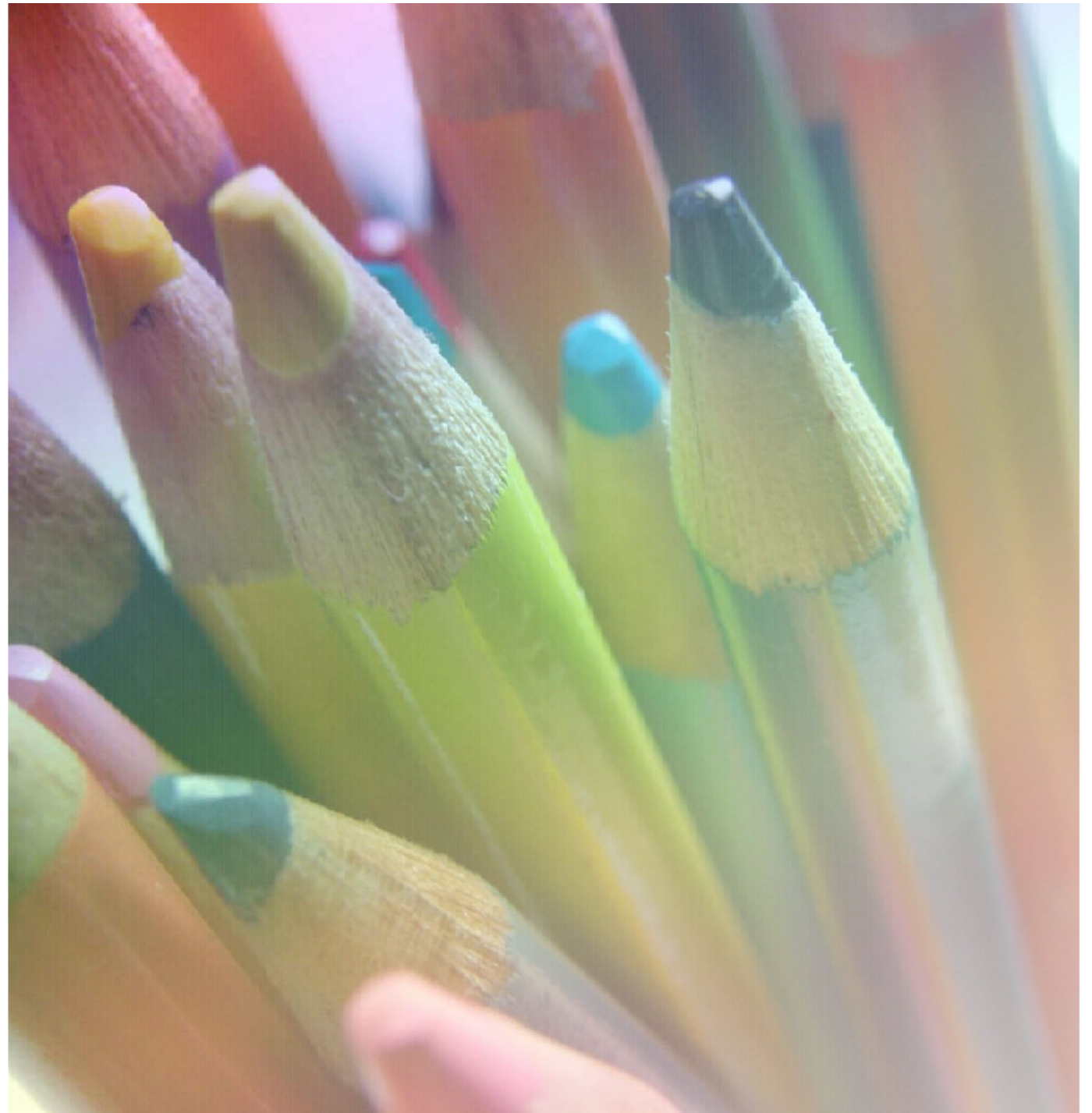

> URBAN

URBAN

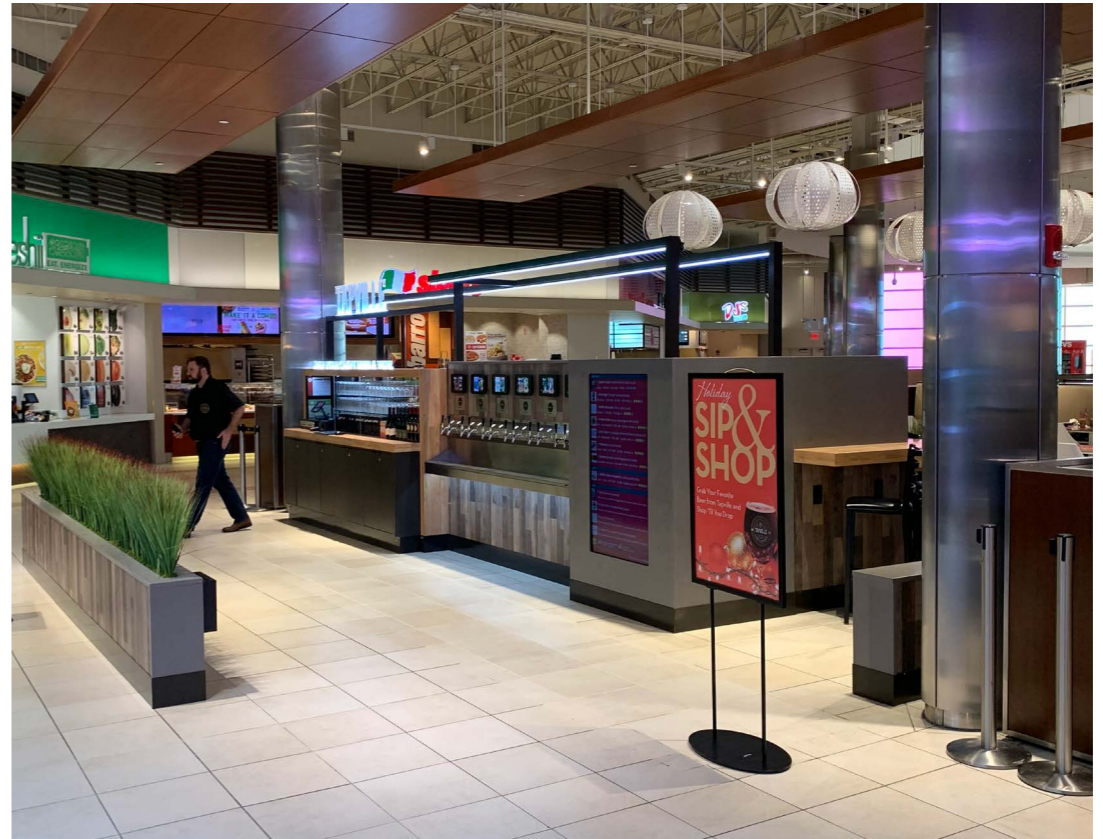

EDGY, FUNKY, STREET SAVVY STYLE, INDUSTRIAL

> ARTISAN

ARTISAN

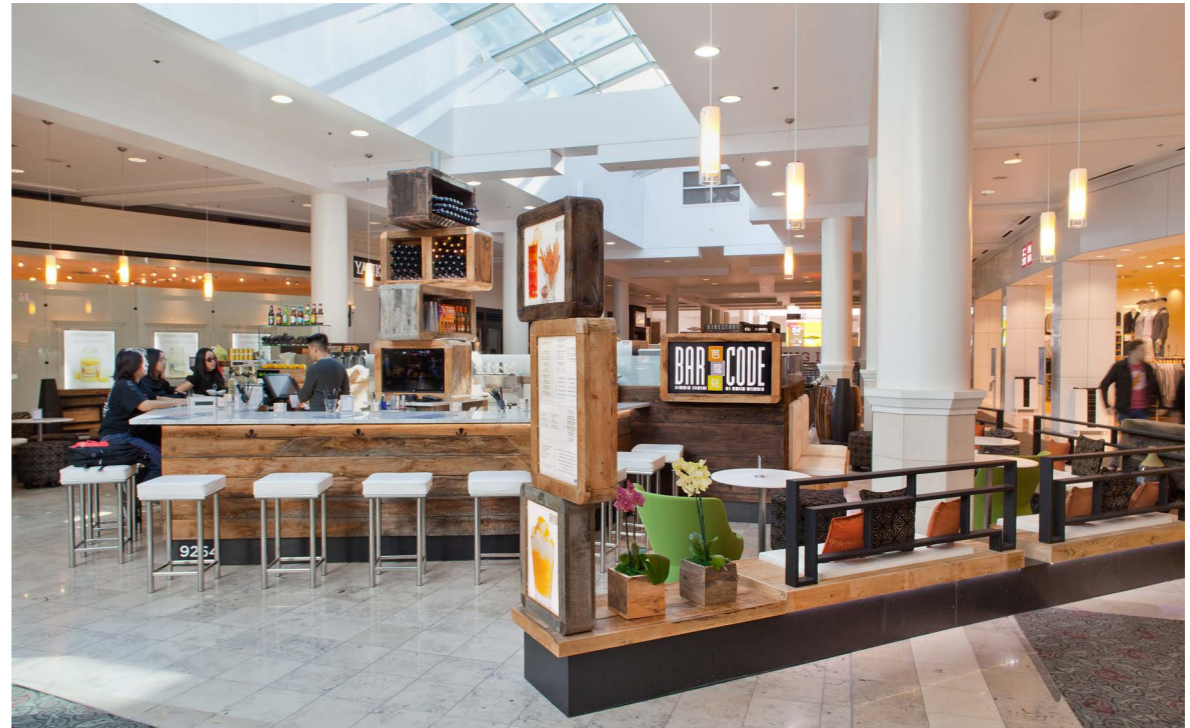

NATURAL, SOPHISTICATED, UNIQUE

> WHIMSICAL

WHIMSICAL



UNEXPECTED, PLAYFUL, COLORFUL

> INVITING

INVITING

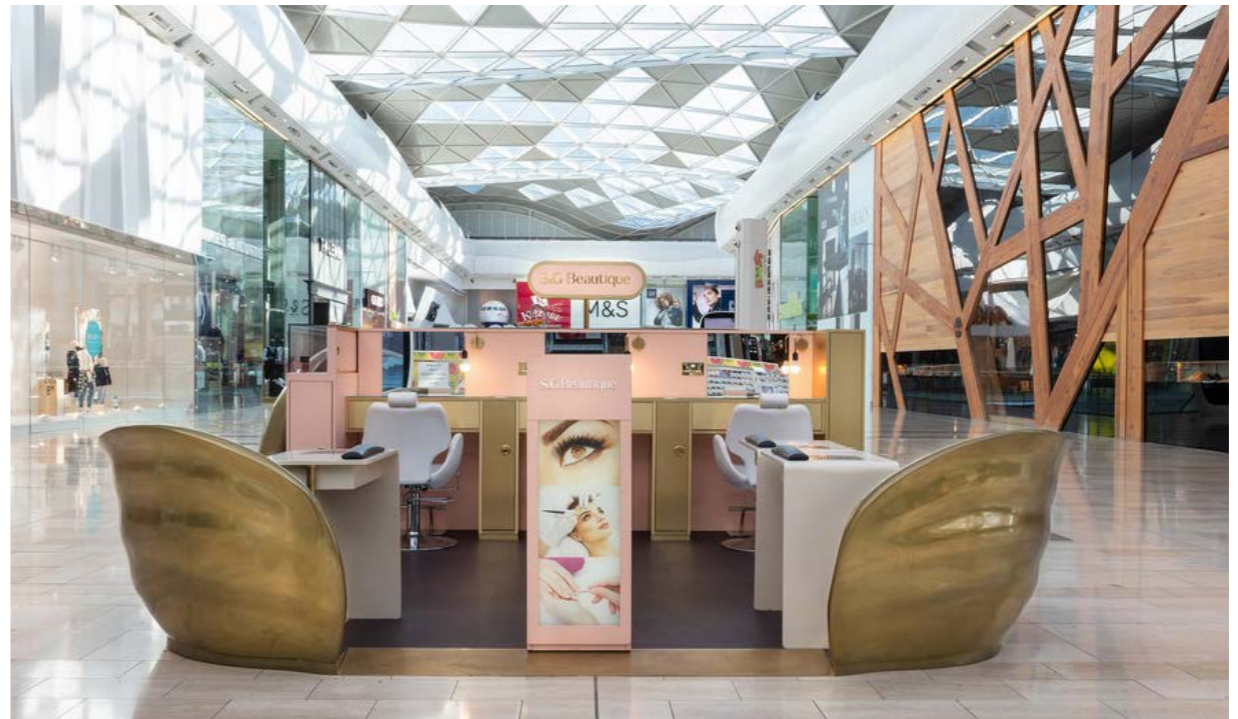
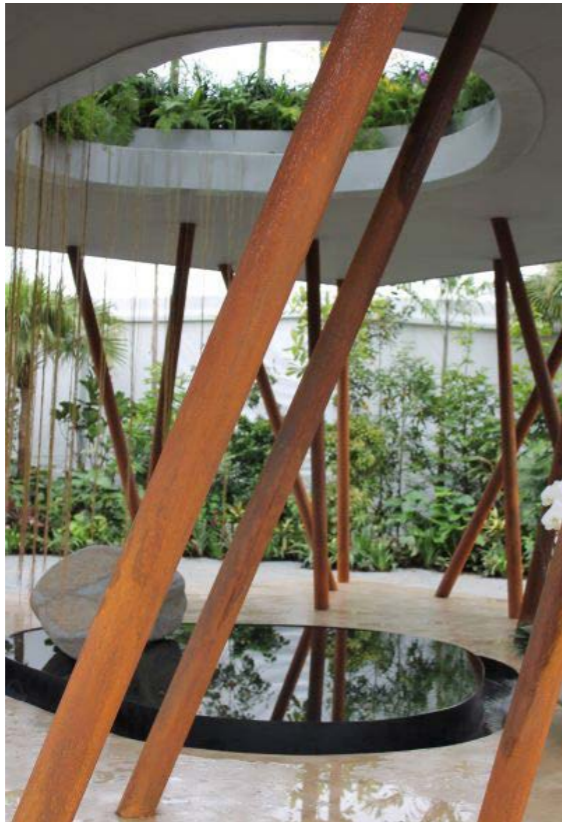

WARM, CALM, OPEN, SOFT

> ARTSY

ARTSY

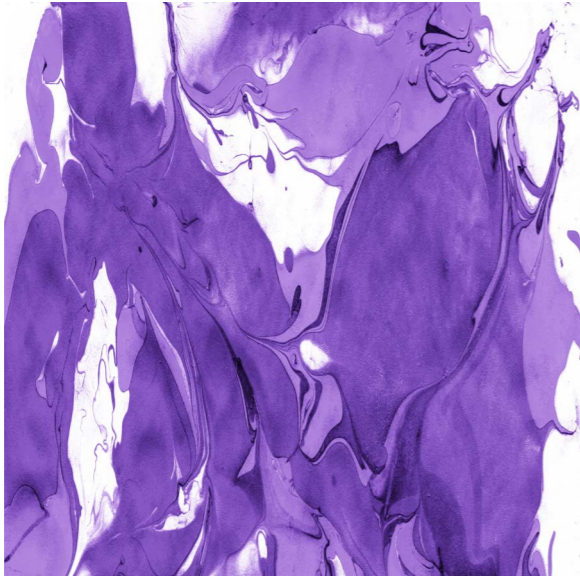

QUIRKY, AVANT GARDE, SURPRISING

> THEATRICAL

T H E A T R I C A L



DRAMATIC, HIGH CONTRAST, MOVEMENT

DESIGN ELEMENTS AND REQUIREMENTS > CONTENTS

- TRAFFIC FLOW
- QUEUING
- SEATING
- LAYERING ELEVATIONS
- VISUAL MERCHANDISING
- BRANDING
- TECHNOLOGY AND MEDIA
- MATERIALS AND FINISHES
- LIGHTING & ILLUMINATION
- ACCESS GATE
- FLOORING
- STORAGE
- TOE KICK
- PYLONS
- DIMENSIONS

SECTIONS OF INTEREST

The following sections provide additional details and requirements related to this Criteria:

- DESIGN INSPIRATION*
Provides visual inspirations for design aesthetics.
- PROPERTY INFO*
Includes information on the Property's building codes, area permitting, and required contractors.
- SUBMITTALS*
Outlines the requirements on how and what to compile for submittals to the Landlord for design reviews.

WELCOME!

This section provides an overview of the numerous design elements and requirements to consider and follow when designing your kiosk. The elements detailed in this section apply to both dry retail kiosks and “wet” food kiosks that prepare food within the kiosk. The next section will detail specific additional elements for food kiosks.



> TRAFFIC FLOW

TRAFFIC FLOW

Taking into account the flow of mall traffic, an open layout can:

- Increase SKUs. The unit can be shopped from the inside and outside.
- Encourages interactive shopping.
- Let's the customer assess your product before they engage, decreasing your sales transition time.
- Creates a more sculptural design, drawing more attention to your product.

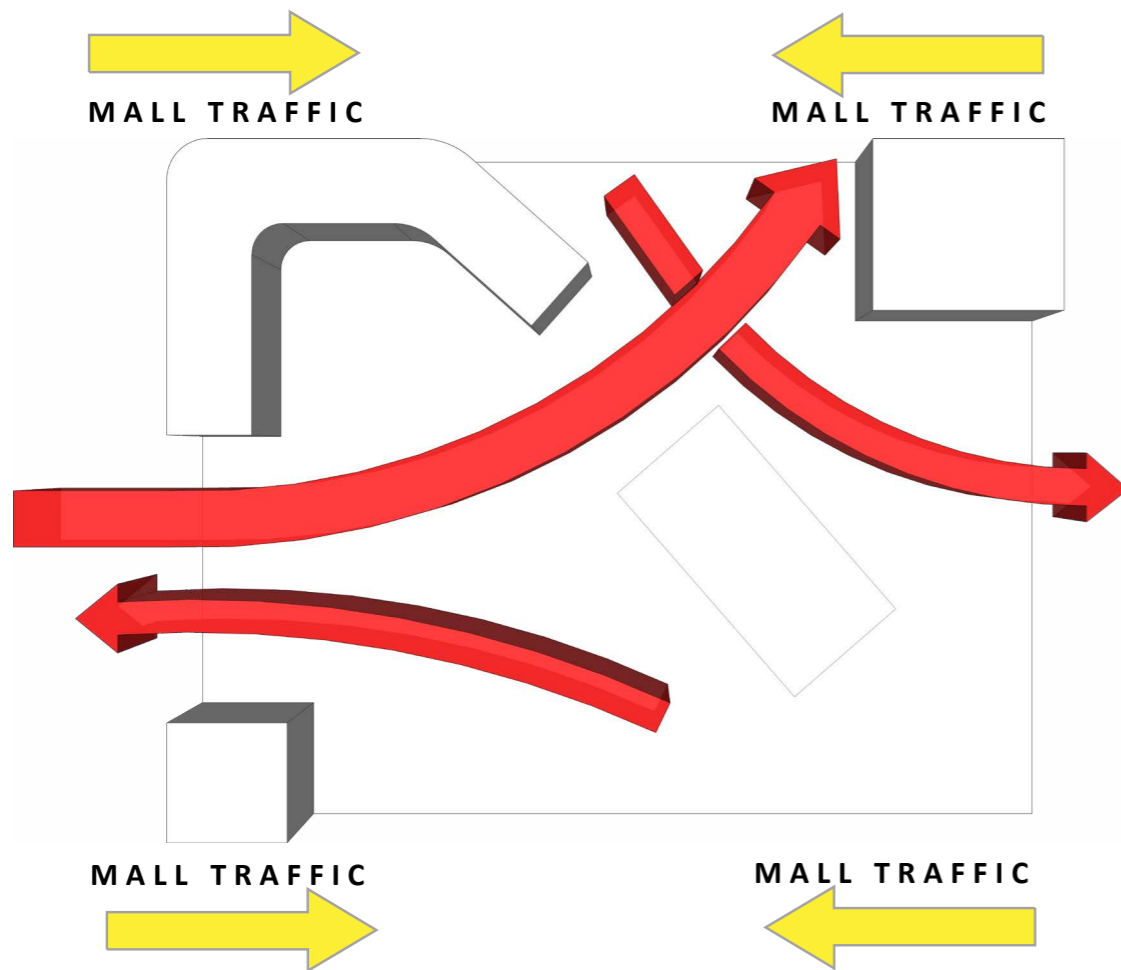

> QUEUING

QUEUING

It is important to consider the flow of Customer traffic as they queue to place an order. Be certain to make accommodations for lines of Customers navigating the space around your kiosk.



> SEATING

SEATING

Macerich's vision is to create food uses as "dwell" areas or destinations for the core Malls.

We encourage curves and angles to differentiate public spaces versus back of house areas for the following reasons:

- Encourages areas for seating and dwelling.
- Creates transitional areas for shopping versus resting.
- Makes for a sculptural design, which in turn draws attention to your business.
- Curves, plants, soft lines create an inviting and relaxing atmosphere to encourage dwell time.

Dedicated kiosk seating is also encouraged.

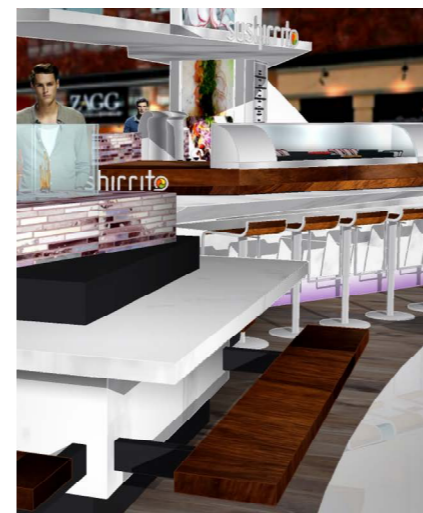
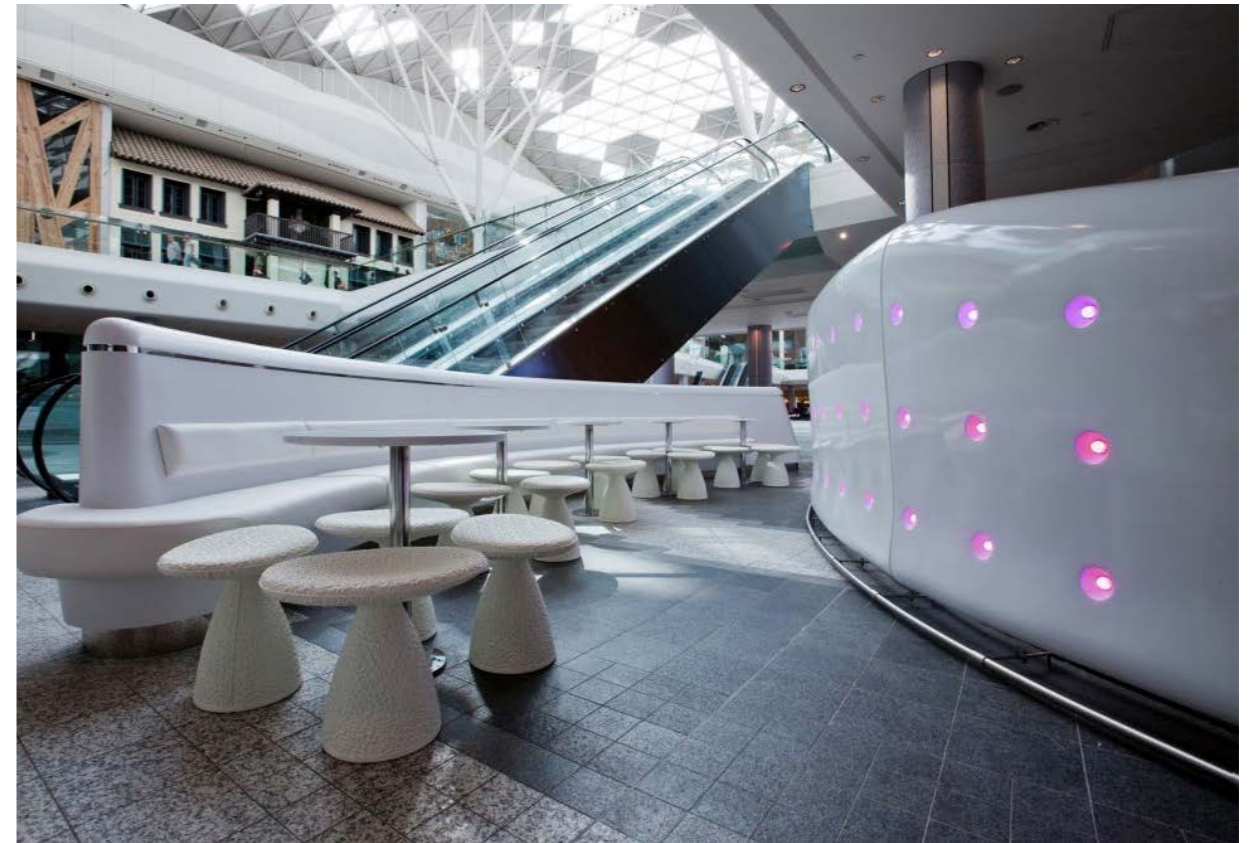

> LAYERING ELEVATIONS

LAYERING ELEVATIONS

Walls and elevations can be used to make a canvas that communicates to your Customer.

An eye catching layered elevation may include:

- Walls with patterns and textures
- Overlays of materials
- Dimensionality
- Molded shapes
- Overlaps to create shadows and depth
- Cove lighting for extra dimensions

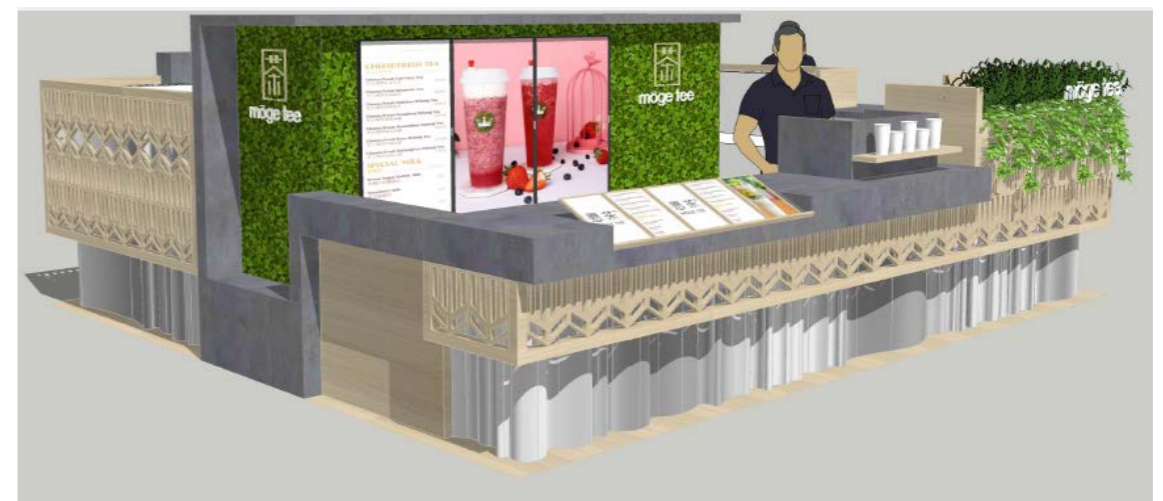

> VISUAL MERCHANDISING

VISUAL MERCHANDISING

Strong visual presentation and merchandising are essential and integral components of retail design.

- Always try to create a triangular composition within style groups or color groups. (display in groups of three or five).
- Start with a center feature, (best sellers / hot items), and merchandise out symmetrically.
- Balance merchandise.
- Color block merchandise to create organized zones.

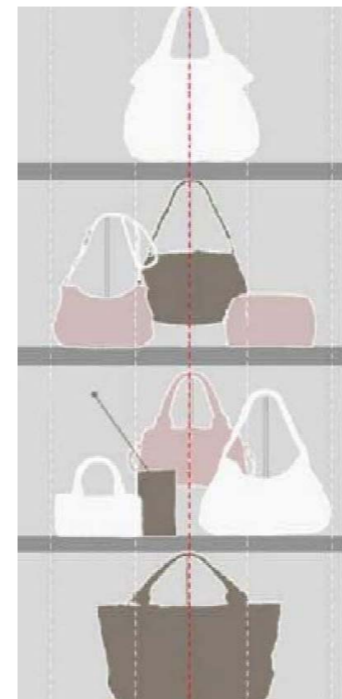

S E T Y O U R S T A G E ,
S E L L A S T O R Y

> BRANDING

BRANDING

A brand is a name, term, design, symbol, color or some other feature that identifies a seller's product or services as distinct from those of other seller's.

Whether you have an established brand or are starting your first business, the kiosk team will work closely with you to enhance your brand look, so you stand out to potential customers and fit with the Macerich experience. This will help you towards the success of your business.

Your branding can be communicated with signage, graphics, materials, shapes, colors, textures, patterns and the overall look and feel of your kiosk, to tell a story and create a lasting experience.

- Taglines are not permitted.
- Graphics must be mounted behind glass or acrylic and secured with stand offs.
- Handwritten signs are not permitted.
- All signage must be approved by the Landlord.



> TECHNOLOGY & MEDIA

TECHNOLOGY AND MEDIA

Technology can enhance your online operation by transforming your kiosk space into a multifunctional one, that lends itself to being an in-store pick up location, payment booth or advertising billboard.

Integrating technology into your kiosk can:

- Become an extension of you.
- Supplement your salesforce with interactive screens for ordering, self-design functions, and more.
- Keep your business connected with your Customer.
- Help you tell a story.
- Help make menu boards easier to update and better communicate your offerings to your Customer via LCD screen loops.

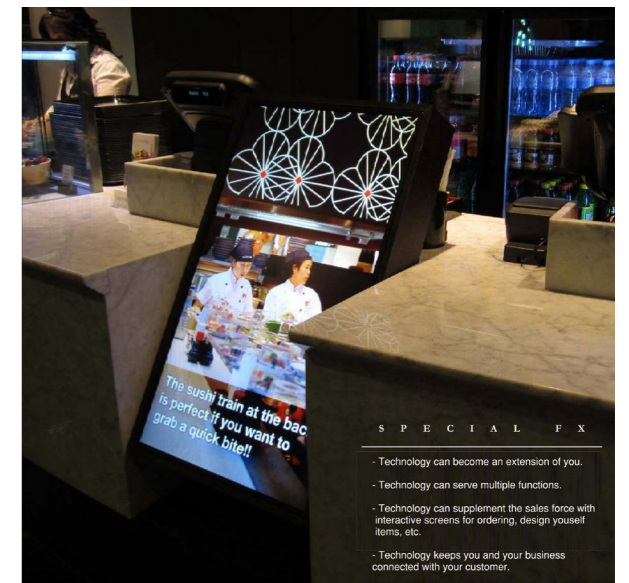

> MATERIALS & FINISHES

MATERIALS AND FINISHES

Kiosks experience heavy foot traffic and engagement. As such, kiosk materials and finishes must be durable and designed to withstand heavy wear and cleaning machinery.

- A material sample board must be submitted for Landlord approval before fabrication can begin.
- Building materials must be fire retardant, fire treated or non-flammable. Class A materials per building codes must be used.
- Selected materials must be authentic and natural such as woods, stones, reclaimed woods, mosaic tiles, etc.
- Plastic laminates are not permitted with the exception of color core or wood pattern high performance plastic laminates.

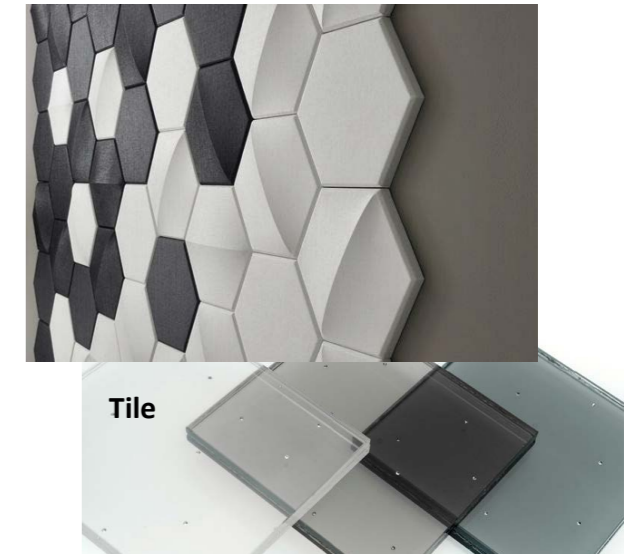

> LIGHTING & ILLUMINATION

LIGHTING AND ILLUMINATIONS

Lighting can be used to draw attention, create depth, and enhance the overall design of your kiosk.

- Light fixtures must be low profile and approved by the Landlord.
- Case lighting must be seamlessly integrated into the design.
- Ensure that the light source is concealed.
- If your kiosk is located under the ceiling, additional lighting elements may be considered but it must be connected to the Tenant's circuit.
- No track lighting or cable hung fixtures are allowed.
- No overhead canopies are allowed.
- All lighting must meet applicable building codes and safety requirements and will require Landlord approval prior to installation.



> FLOORING

FLOORING

Flooring is an important design element in an open kiosk layout for the following reasons:

- It is inviting and welcoming.
- It defines your footprint.
- Conduits can be run between cabinetry beneath the floor.

We encourage a wood flooring material like plank, for a warm look and feel.

Flooring requirements include:

- All flooring must be approved by Landlord prior to installation.
- It is a code requirement to comply with the ADA. (1" = 12" - transitional slope).
- Flooring must be laid over existing mall flooring. Mall flooring is not permitted to be removed.

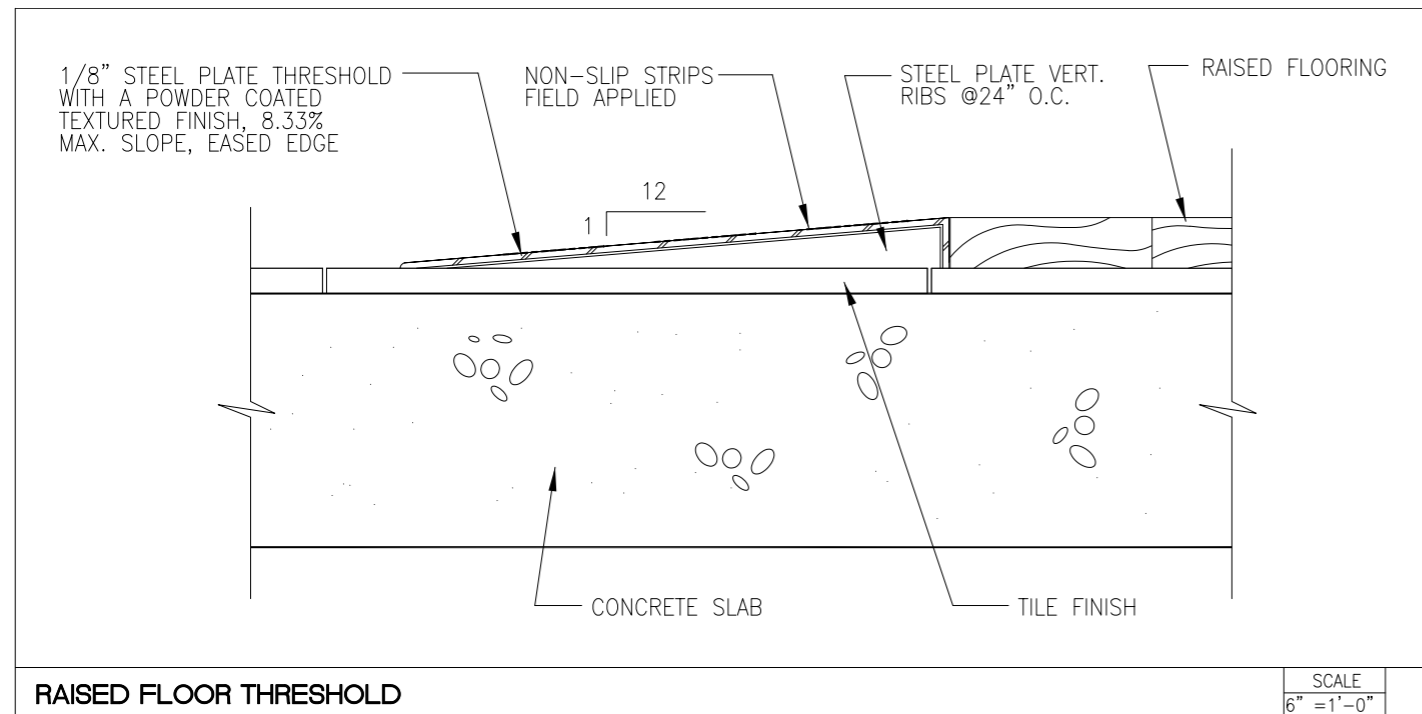

> ACCESS GATE

ACCESS GATE

A gate to enter a kiosk is a necessity. However it is not necessary for the customer to know where the gate is located.

- The gate must be seamlessly integrated into the overall design, to avoid being an eyesore.
- The gate shall be installed no more than 1" maximum above the finished floor.



> STORAGE

STORAGE

Maximizing sales volume naturally requires product storage within your kiosk. Storage should be integrated into your design to make it invisible to the customer.

- All interior storage must have doors or fixed fronts within the retail space.
- All cabinet hardware must be low profile, commercial grade stainless steel.
- Integrate all countertop displays into the design. No freestanding loose spinners or displays are permitted.
- All front counter service equipment must be shrouded to conceal cables or loose items from public view.
- Bins and brochure holders must be integrated into the overall design.
- Low profile hardware for cabinets and drawers are required.
- Merchandise must be placed in shelving that is designed in line with the kiosk's overall look and feel.
- Equipment, cords, cables, and loose items are required to be hidden from the public view. Your kiosk design should include shrouding.

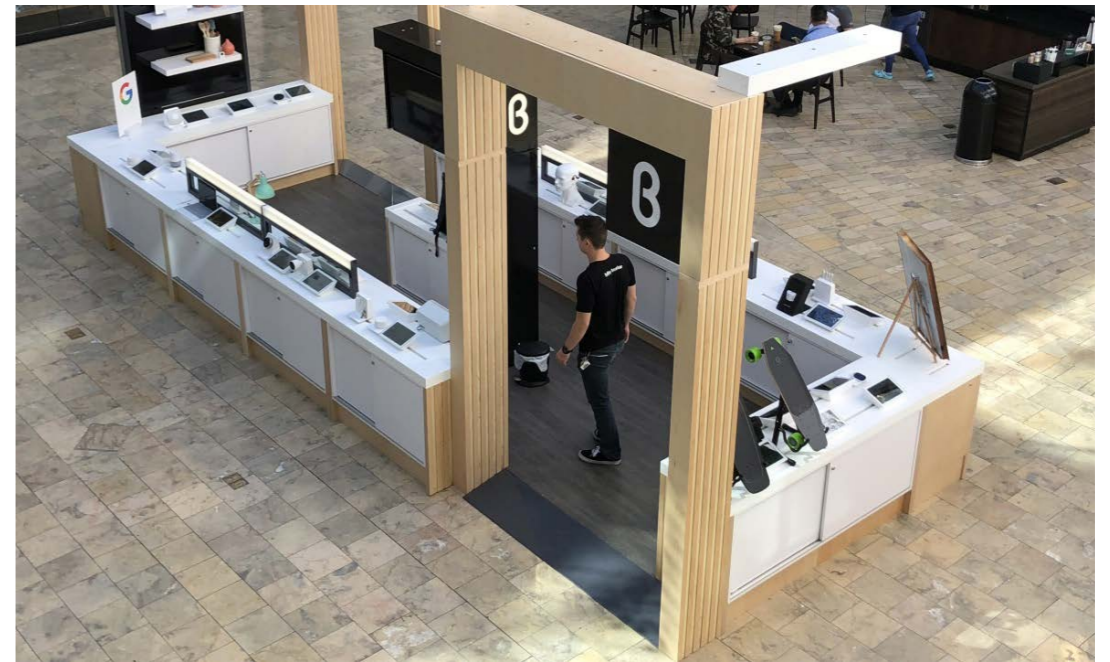

> TOE KICK

TOE KICK

Toe kicks are important as they minimize damage to your kiosk from foot traffic and cleaning machinery.

- Kick material must be durable.
- Kick should be 6" high and 3" inset.
- An 1/8" metal extrusion at the toe kick is required to protect kiosk finishes from foot traffic and cleaning machines.



> PYLONS

PYLONS

We encourage your design incorporate a pylon shape that enhances your brand experience and communicates what you are offering.

If your lease line includes a column, you have a unique opportunity to brand it with additional signage and accent lighting.

- Design must be integrated and coherent with the retail design.
- Max allowable size is 7' tall by 3' wide.
- Secondary pylons are encouraged at a maximum size of 4' tall by 3' wide.
- Freestanding neon or neon lit signs are not permitted.
- All signage must be approved by the Landlord prior to installation.

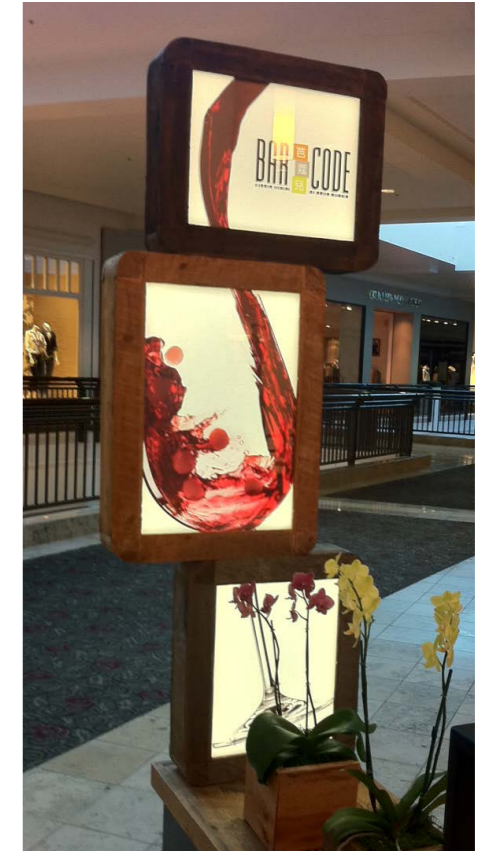

> DIMENSIONS

DIMENSIONS

We want your kiosk to stand out and attract customers through excellent design. With that in mind, it is also important to keep common area sight lines open. To achieve this, we have a few dimensional requirements to follow:

- A maximum height for opaque walls is 4'-0", with a 1'-0" translucent glass shroud up to a 5'-0" total height, where required by the Health Department.
- Max allowable pylon size is 7'-0" tall by 3'-0" wide.
- Secondary pylons are encouraged at a maximum size of 4'-0" tall by 3'-0" wide.

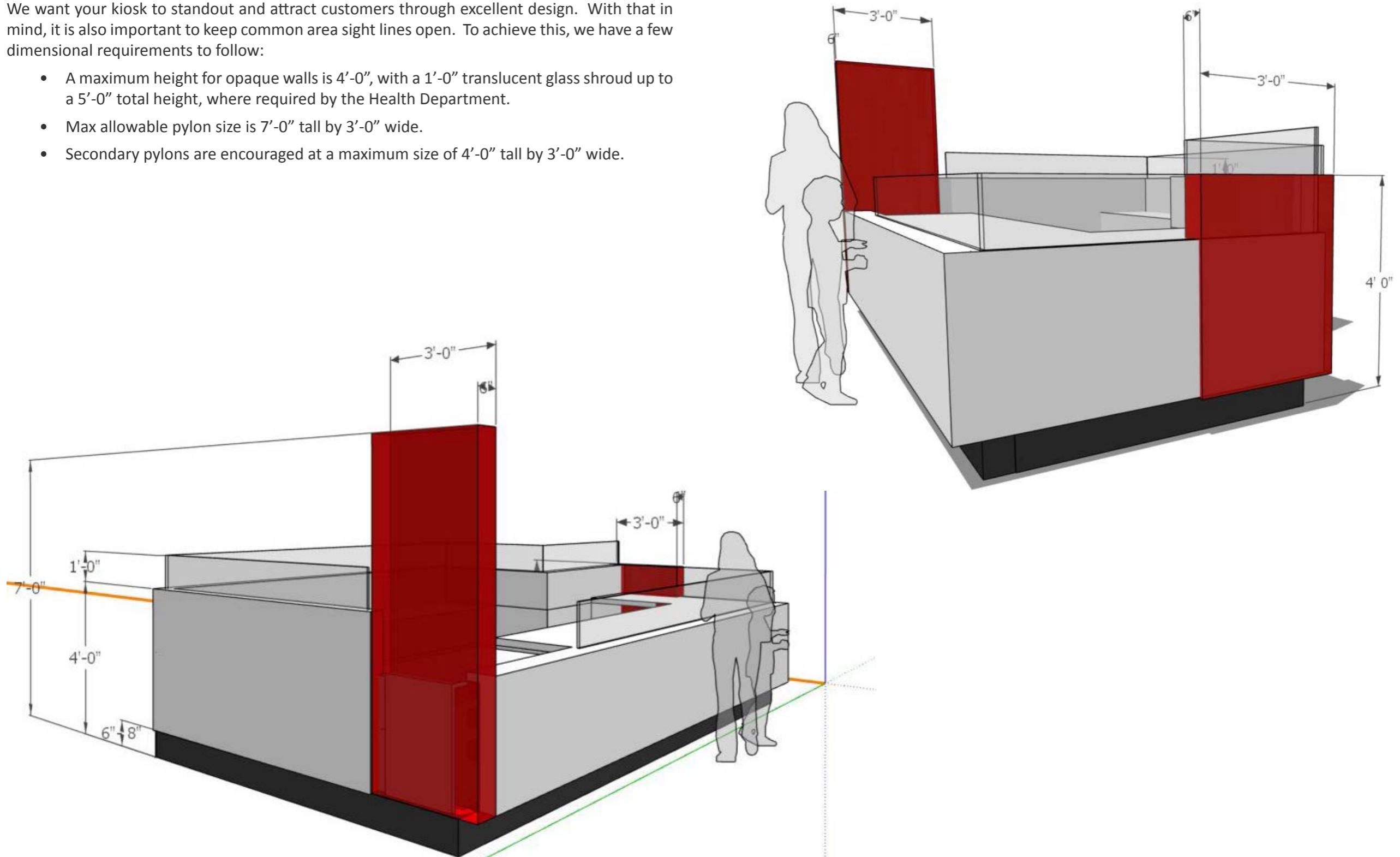

FOOD DESIGN ELEMENTS AND REQUIREMENTS > CONTENTS

- FOOD DISPLAY**
- FOOD PREPARATION AREA**
- MENU BOARDS**
- CONDIMENTS AND UTENSILS**

SECTIONS OF INTEREST

The following sections provide additional details and requirements related to this Criteria:

- DESIGN INSPIRATION*
Provides visual inspirations for design aesthetics.
- PROPERTY INFO*
Includes information on the Property's building codes, area permitting, and required contractors.
- SUBMITTALS*
Outlines the requirements on how and what to compile for submittals to the Landlord for design reviews.

A FEAST FOR YOUR EYES!

This section provides an overview of the specific design elements and requirements to consider for a “wet” food producing kiosk. It is important to embrace the cooking and display of food as an integral design element to your kiosk. Food is a great tool to entice the consumer.



> FOOD DISPLAY

FOOD DISPLAY PRESENTATION

We encourage you to incorporate food display of your goods to showcase your brand to Customers. Presenting freshly made options from the menu will entice the eyes of your customer and provide an instant way to purchase an item. Labeling your items helps identify your offerings.

- Food displays must be appetizing and behind clean and clear glass.
- Labels should accent the design of your kiosk.
- Signage should be professionally printed on card stock and utilize proper display methods.



DISPLAY THE GOODS IN AN APPETIZING MANNER.



> FOOD PREPARATION AREA

FOOD PREPARATION AREA

Visual food preparation is an added value to your brand experience, resulting in excitement and interaction for the Customer.

- Obstructive overhead canopies are not permitted. An alternative solution to an overhead canopy should be used if one is required by the Health Department.
- Check local building codes for requirements on plumbing venting inside a wall or if it occurs on the exterior wall.
- Odor producing equipment is not permitted. Tenants must enclose all odor within their premise.



> MENU BOARD

MENU BOARD

Your menu board is a vital brand element to communicate your product to the Customer.

- Design must be integrated and coherent with the retail design.
- Loose menu boards are not permitted.
- The top of the menu board may not exceed a height of 5'. The only exception is when the menu board is located on a pylon.

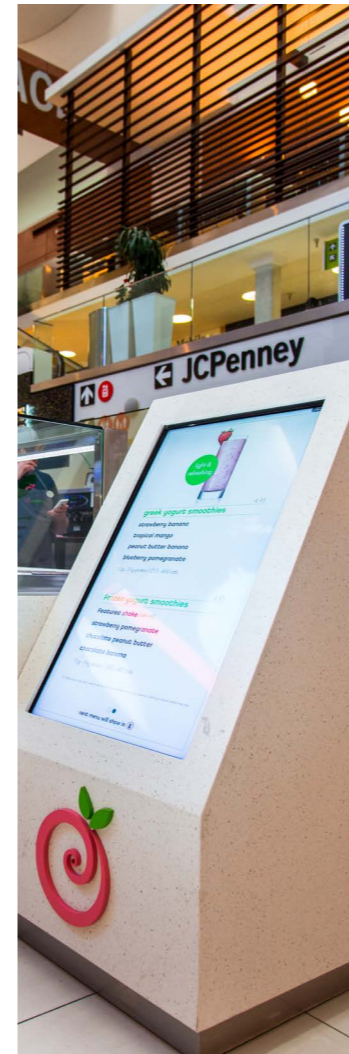

> CONDIMENTS & UTENSILS

CONDIMENTS AND UTENSILS

Condiments, utensils, napkin holders, etc., can be an eyesore if not properly accounted for in the kiosk design.

- Items must be integrated seamlessly into the overall kiosk design.
- Loose items on the countertops are not permitted.



> ELECTRIC / DATA / PLUMBING / STORAGE

OVERVIEW

The Technical Criteria is designed to provide building details and design requirements for the Property's technical systems.

It is the Tenant's responsibility to verify existing conditions and comply with all applicable codes and standards for all technical systems.

Tenants are required to adhere to the full Criteria during their design and construction.

ELECTRIC

Most retail kiosk spaces are typically provided 20 amps of low voltage power stubbed into a J-Box under the floor. In certain kiosk locations, more power exists. It is the responsibility of the Tenant to field verify the amount of existing power in their Premises, to ensure it suits the Tenant's needs, prior to signing the Lease.

Tenant kiosk installations are typically required to tap into the provided power, and distribute inside their kiosk. The following requirements must be met:

- **IDENTIFY** all Tenant equipment in the Mall electric room with clear labels that include the Tenant name and space number.
- **CUTTING AND PATCHING** must be provided by Tenant.
- **MATERIAL AND EQUIPMENT** must be new and of a commercial grade with UL Labels and where such labeling applies.
- **WATERTIGHT FLOOR BOXES** are required.
- **EXPOSED WIRING** is not permitted. All wiring of any type must be installed in conduit or must be metal clad cable (MC). Metal clad cable will only be allowed for concealed branch circuit wiring within the demised premises. Flexible conduits must be used for connections to vibrating equipment.
- **EXPOSED LOW VOLTAGE** wiring must be plenum graded.

DATA AND COMMUNICATIONS

Kiosk spaces are typically provided an empty conduit with a pull string stubbed into a J-Box under the floor.

- **DATA SETUP AND SERVICE INSTALLATION** is the Tenant's responsibility to coordinate direct through Granite Grid. Other data providers are not permitted at this property as they do not have an access agreement in place.
- **TELEPHONE DEMARC WORK** must be performed by Landlord's approved telephone subcontractor, Granite Grid.
- **TELEPHONE SERVICE** is the Tenant responsibility to coordinate directly through Granite Grid and install within their premises.

PLUMBING

Kiosk spaces may or may not have existing wet utilities. It is the responsibility of the Tenant to field verify the wet utilities in their Premises, to ensure it suits the Tenant's needs, prior to signing the Lease.

Tenant kiosk installations are typically required to core into the floor, tap into the provided plumbing, and distribute inside their kiosk. The following requirements must be met:

- **GARBAGE DISPOSALS** are not allowed.
- **HAIR RECEPTORS** must be installed on all sinks, basins, and special sanitary units which may in any way receive human or animal hair.
- **GREASE INTERCEPTORS** must be installed within the kiosk footprint.
- **KITCHEN SINKS** including pot sinks, scullery sinks, pre-wash sinks and other kitchen units must be connected to a grease trap as per code.
- **DISHWASHERS** may not be connected to grease trap.
- **OIL COLLECTION AND HAULING SYSTEM** is required for Tenants with fryers or other grease/oil generating equipment that does not run through an interceptor. Landlord does not provide a centralized collection point.
- **FLOOR PENETRATIONS AND PLUMBING** by Tenants must be coordinated with the Landlord.

PROCESS > DESIGN KICKOFF / DESIGN SUBMISSION / PERMITTING & CONSTRUCTION

This section provides a brief overview of the design, permit, and installation process steps to get your kiosk open.

DESIGN KICKOFF

We want to help you create an incredible kiosk to maximize your brand’s potential. Your Tenant Coordinator will contact your team to schedule a design kickoff call. The purpose of this call is to collaborate on your design intent and help you understand the requirements in this Criteria.

DESIGN SUBMISSION AND REVIEW

Requirements on how and what to submit for the Landlord drawing review of your kiosk can be found in the [SUBMITTALS CRITERIA](#).

PERMITTING AND CONSTRUCTION

An overview of both the City/Municipalities permit process and the Landlord’s construction requirements can be found in [PROPERTY INFO](#).

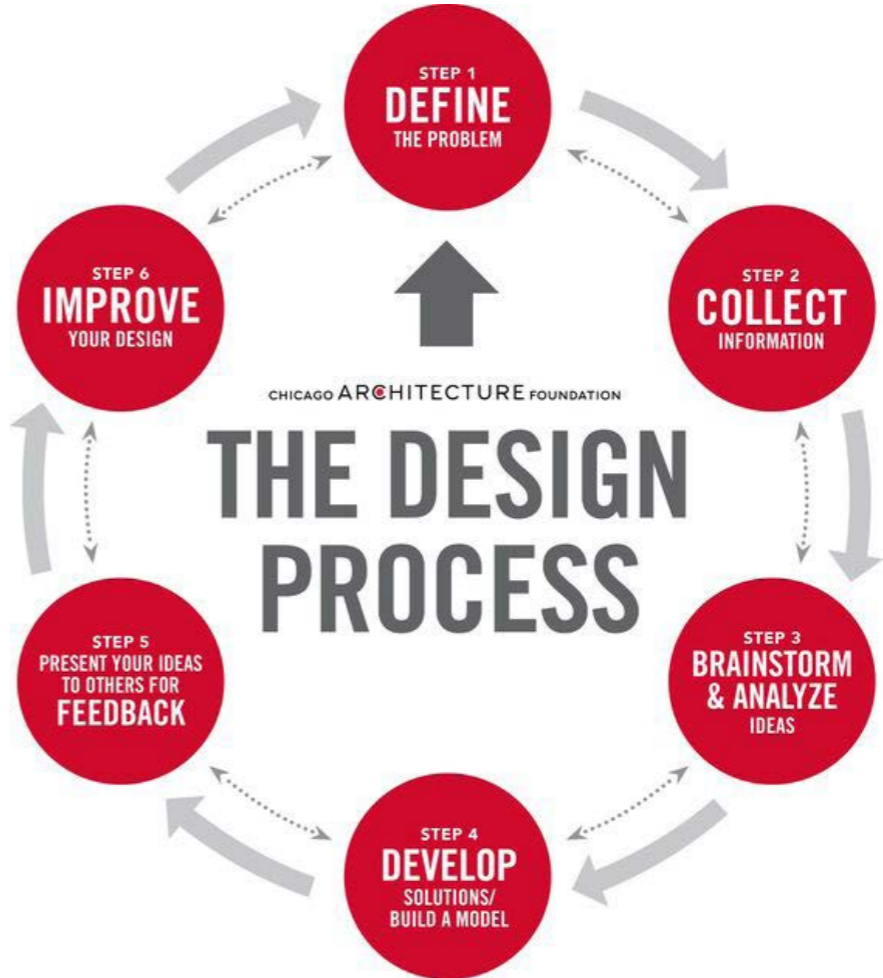

DESIGN DETAILS > GLASS SHROUD / GATE

The following design details are required to be shown in your final design drawings. These details will help to ensure your kiosk is sturdy and built to last.

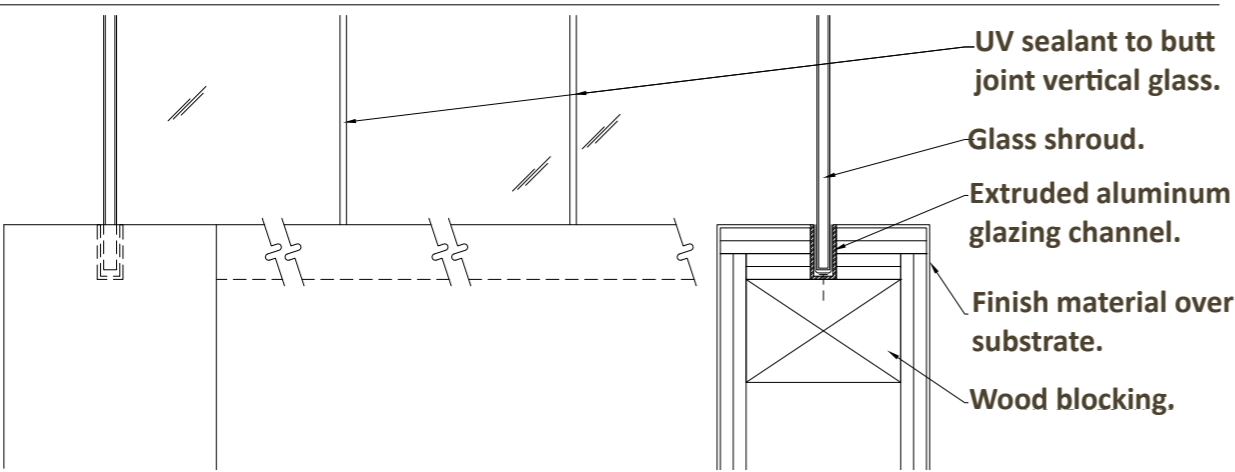

GLASS SHROUD DETAIL

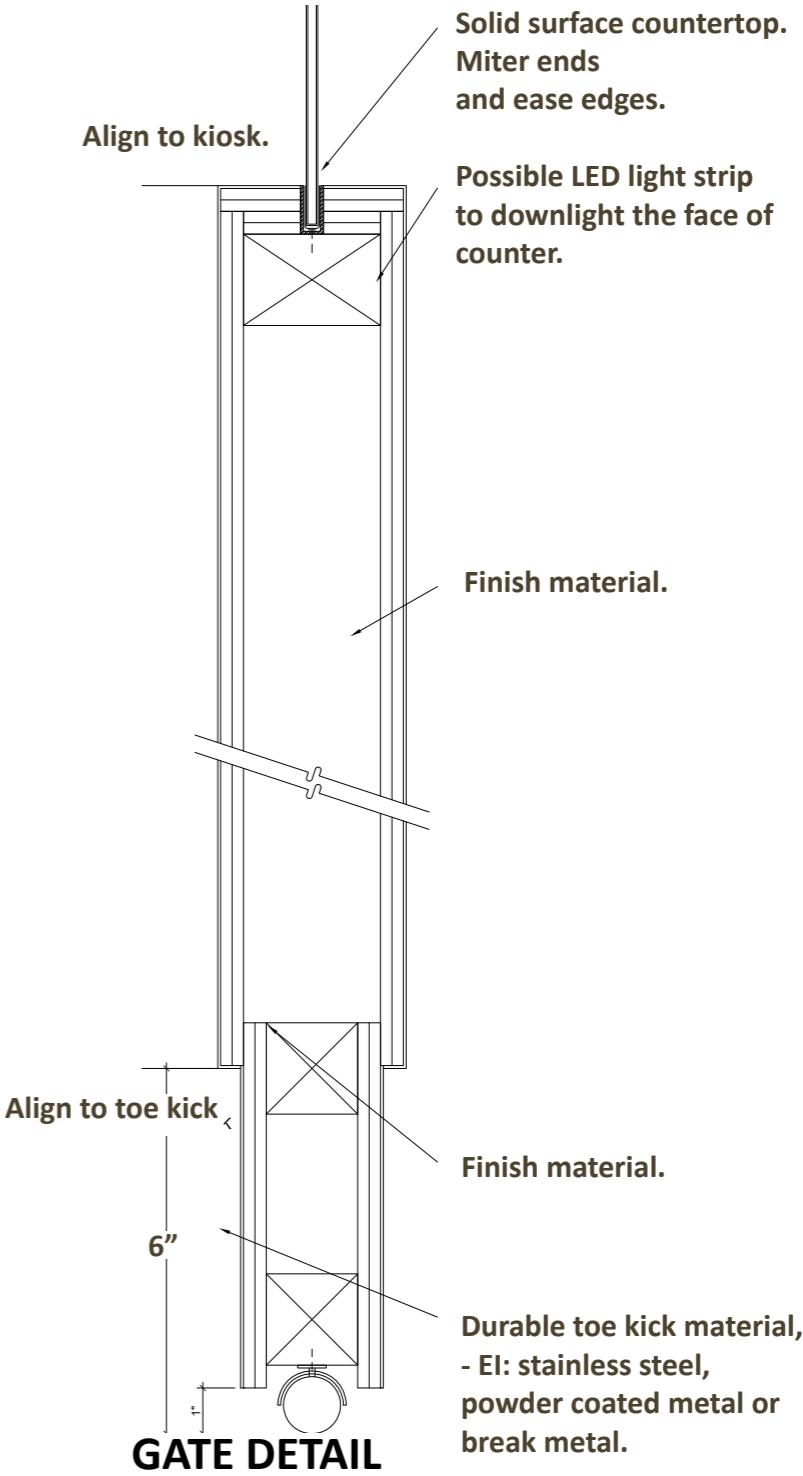

GATE DETAIL

DESIGN DETAILS > CORNER / GRAPHIC FRAME

Note: Can be used for vertical corner only.

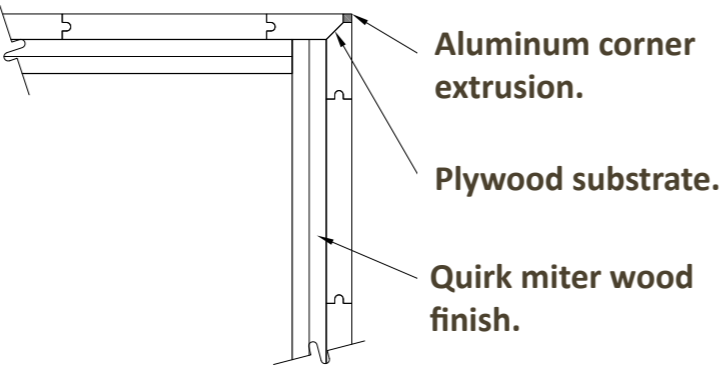

CORNER DETAIL

Note: Can be used for vertical corner only.

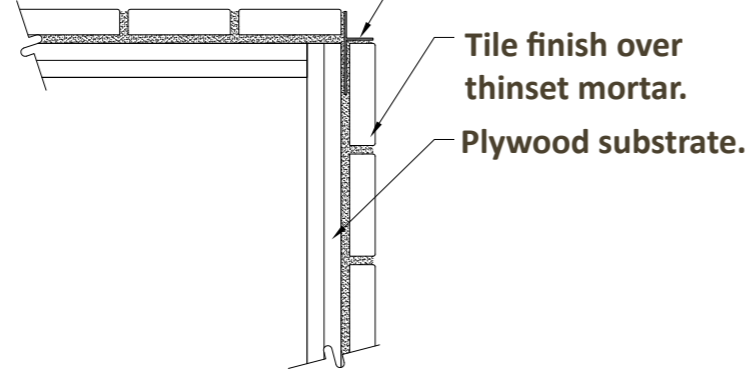

CORNER DETAIL

Note: For interchangeable frameless graphic panels, change graphic from back via concealed hinges and reveal details. (for back lit panels as well to replace lights). Use concealed / magnet activated locks to secure door.

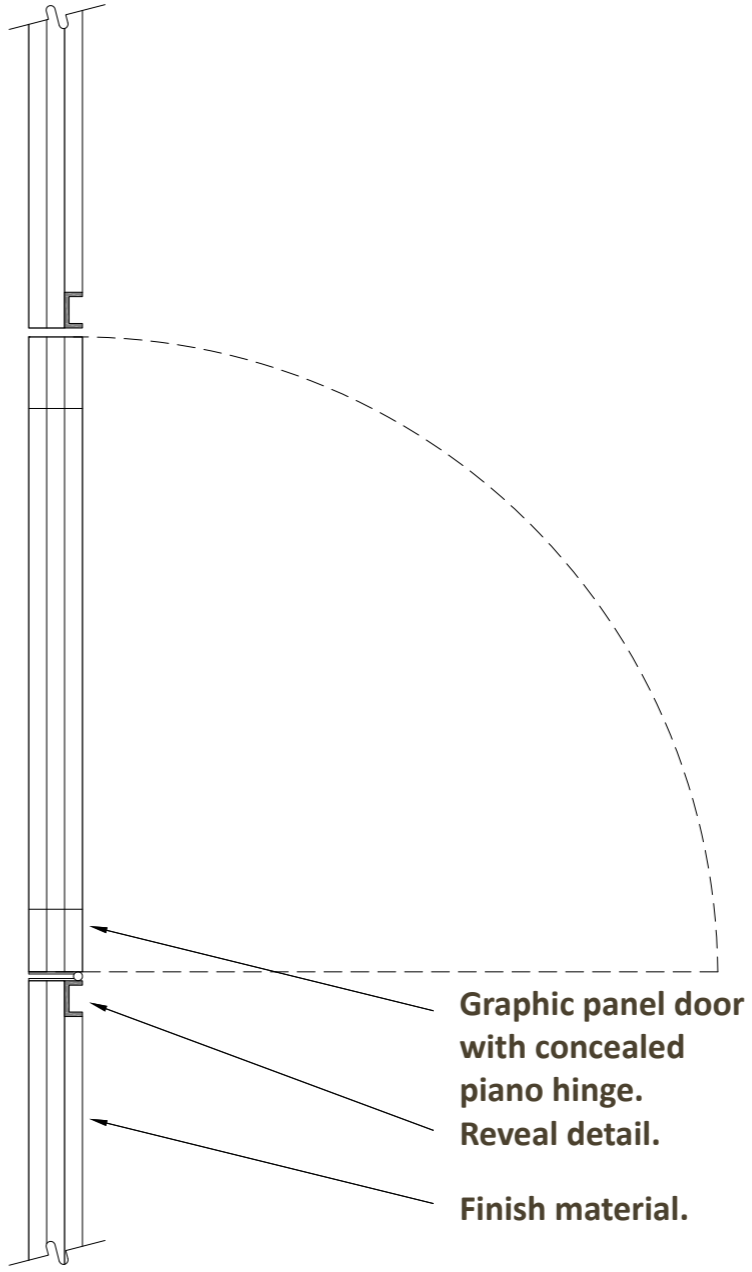

GRAPHIC FRAME DETAIL

ZONE 1: LEVEL 1 CRITERIA

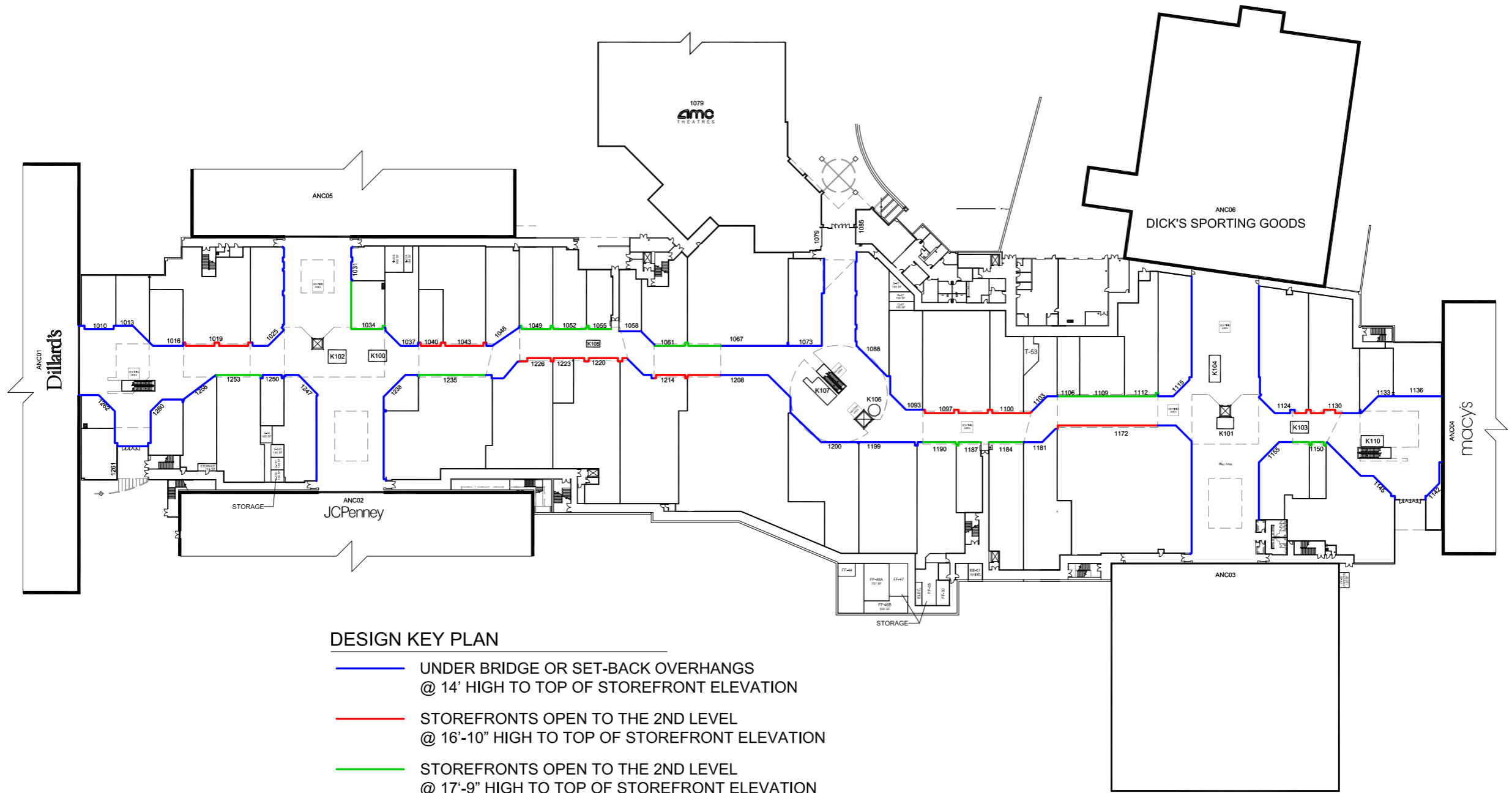

DESIGN KEY PLAN

- UNDER BRIDGE OR SET-BACK OVERHANGS
@ 14' HIGH TO TOP OF STOREFRONT ELEVATION
- STOREFRONTS OPEN TO THE 2ND LEVEL
@ 16'-10" HIGH TO TOP OF STOREFRONT ELEVATION
- STOREFRONTS OPEN TO THE 2ND LEVEL
@ 17'-9" HIGH TO TOP OF STOREFRONT ELEVATION

ZONE 1: LEVEL 1 EXAMPLES



ZONE 2: LEVEL 2 CRITERIA

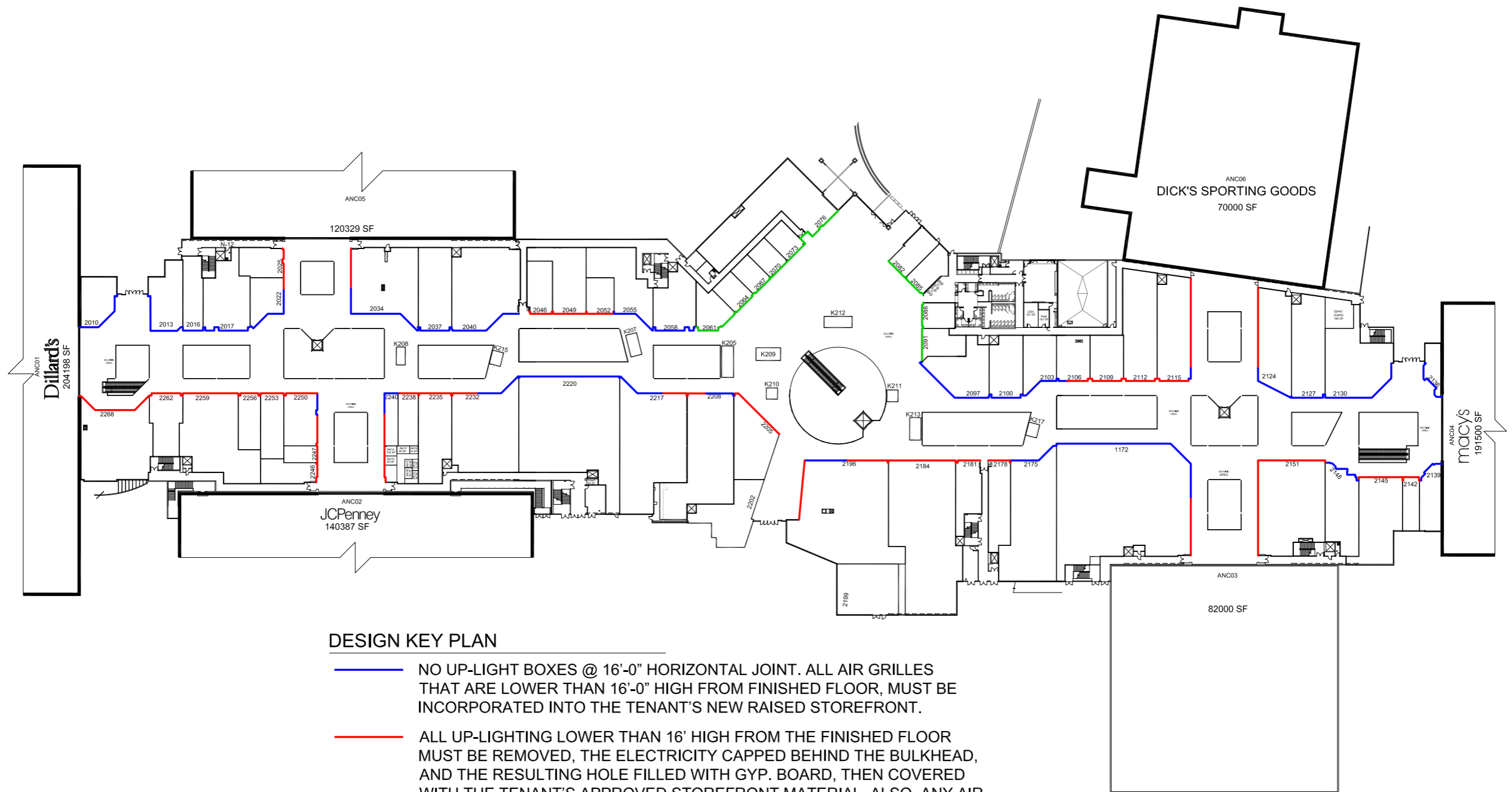

DESIGN KEY PLAN

- NO UP-LIGHT BOXES @ 16'-0" HORIZONTAL JOINT. ALL AIR GRILLES THAT ARE LOWER THAN 16'-0" HIGH FROM FINISHED FLOOR, MUST BE INCORPORATED INTO THE TENANT'S NEW RAISED STOREFRONT.
- ALL UP-LIGHTING LOWER THAN 16' HIGH FROM THE FINISHED FLOOR MUST BE REMOVED, THE ELECTRICITY CAPPED BEHIND THE BULKHEAD, AND THE RESULTING HOLE FILLED WITH GYP. BOARD, THEN COVERED WITH THE TENANT'S APPROVED STOREFRONT MATERIAL. ALSO, ANY AIR GRILLES IN THIS AREA MUST BE INCORPORATED INTO THE TENANT'S APPROVED STOREFRONT DESIGN.
- FOOD COURT STOREFRONT AREA

ZONE 2: LEVEL 2 EXAMPLES



NEUTRAL PIER DETAILS

4" wide x 4" deep neutral reveal required around storefronts.

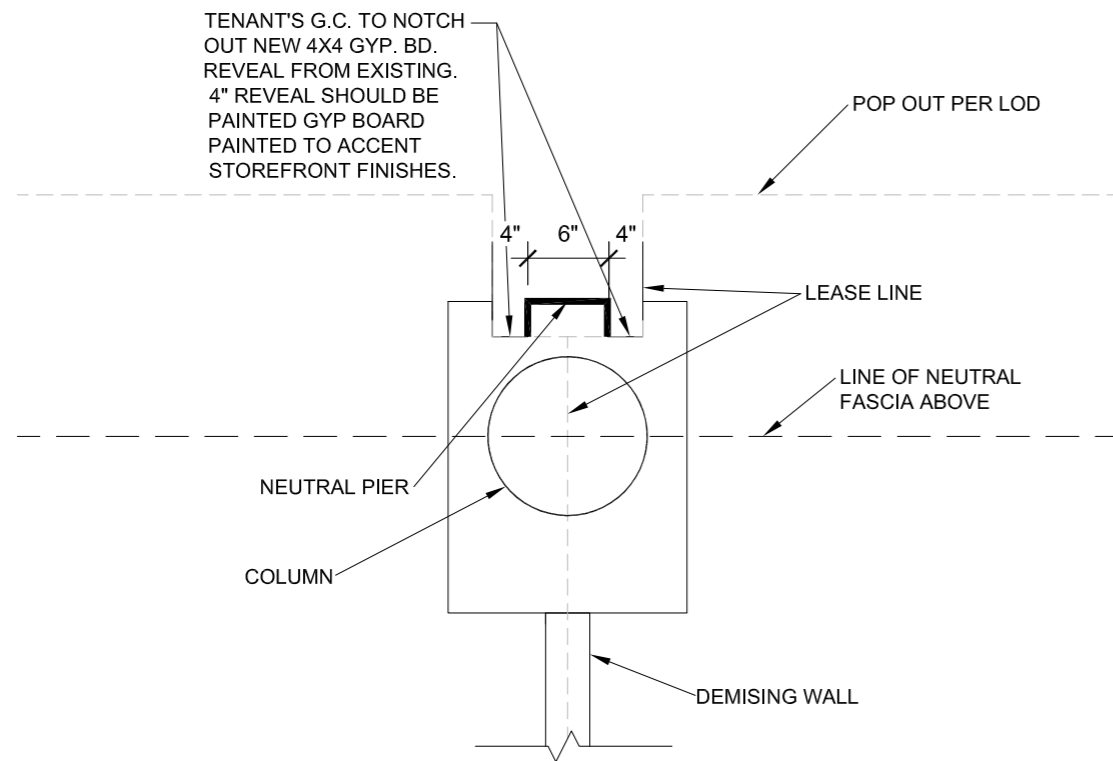

TYPICAL NEUTRAL PIER DETAIL @ COLUMN

*CONTACT MALL T.C. FOR MORE INFORMATION N.T.S.

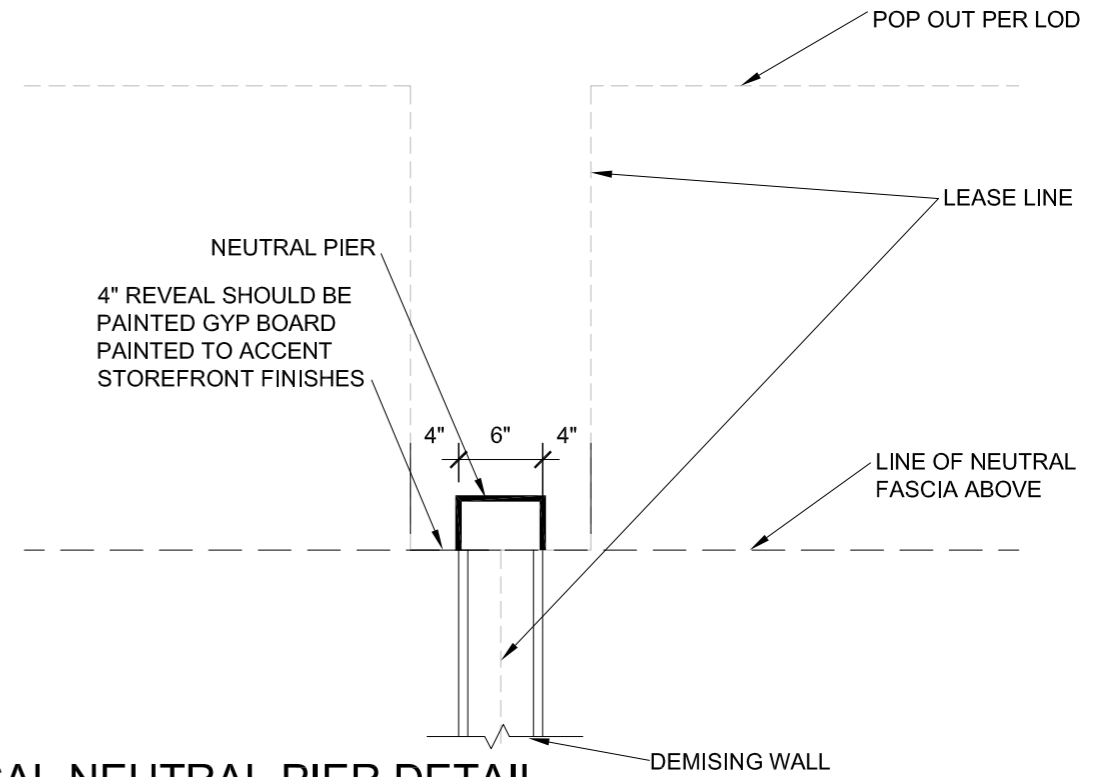

TYPICAL NEUTRAL PIER DETAIL

*CONTACT MALL T.C. FOR MORE INFORMATION N.T.S.

NEUTRAL PIER DETAILS - ZONE 1: LEVEL 1 TENANTS

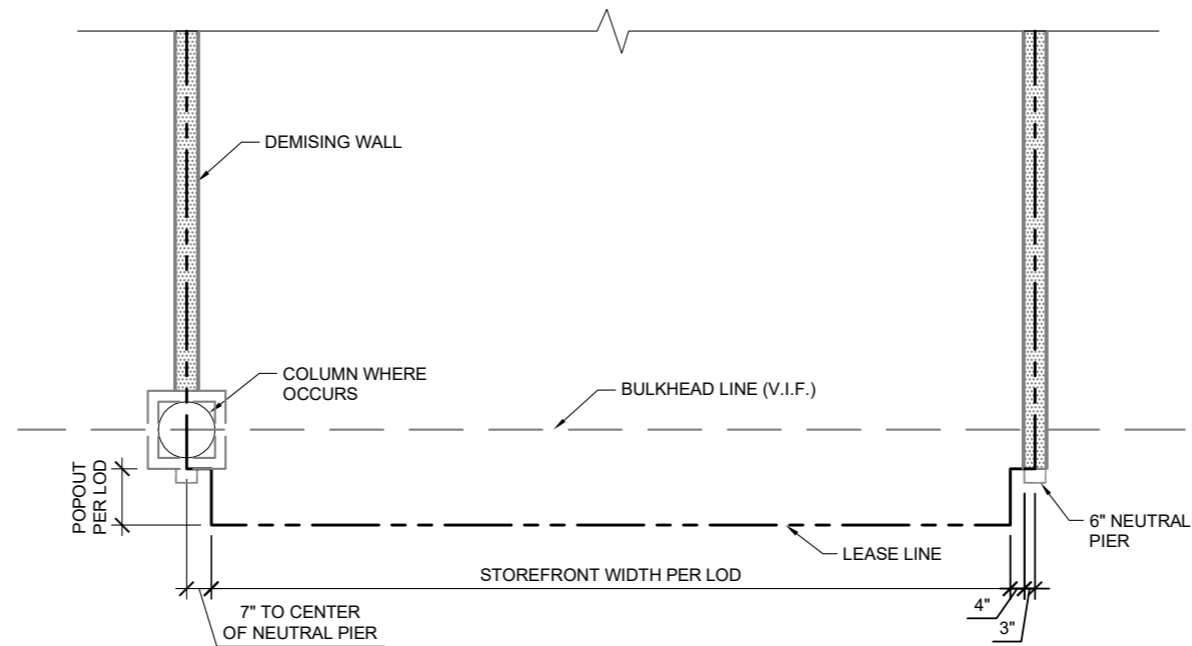

LOWER LEVEL PLAN (TYP.)
NOT TO SCALE - TENANT TO VERIFY ALL EXISTING CONDITIONS

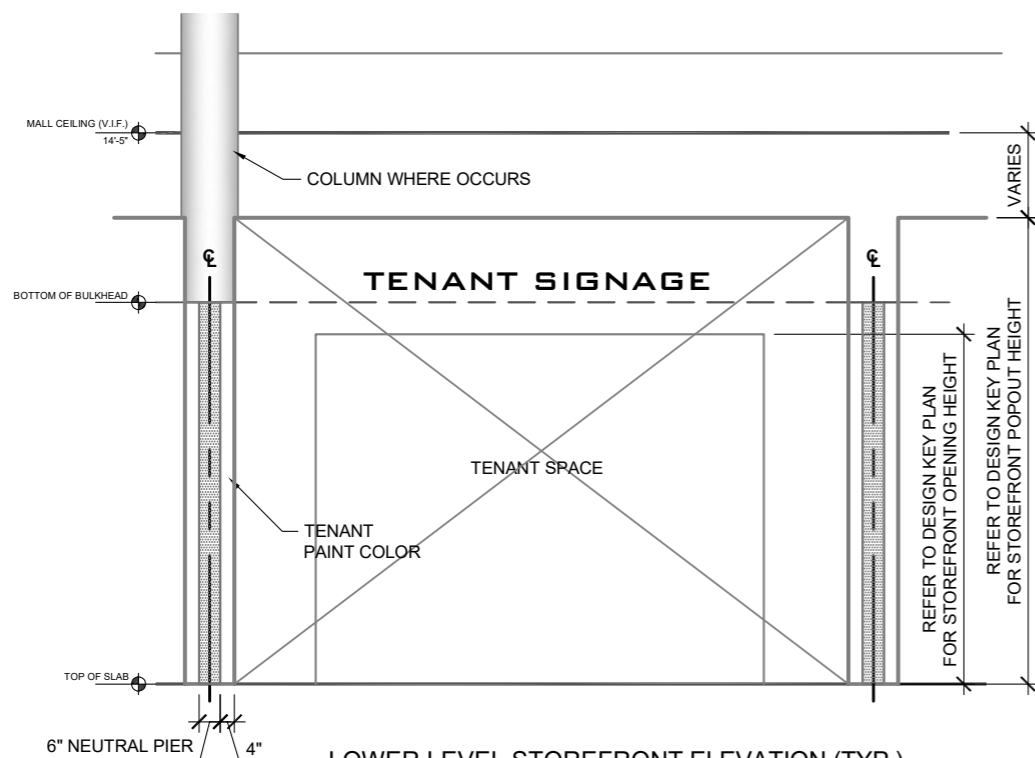

LOWER LEVEL STOREFRONT ELEVATION (TYP.)
NOT TO SCALE - TENANT TO VERIFY ALL EXISTING CONDITIONS

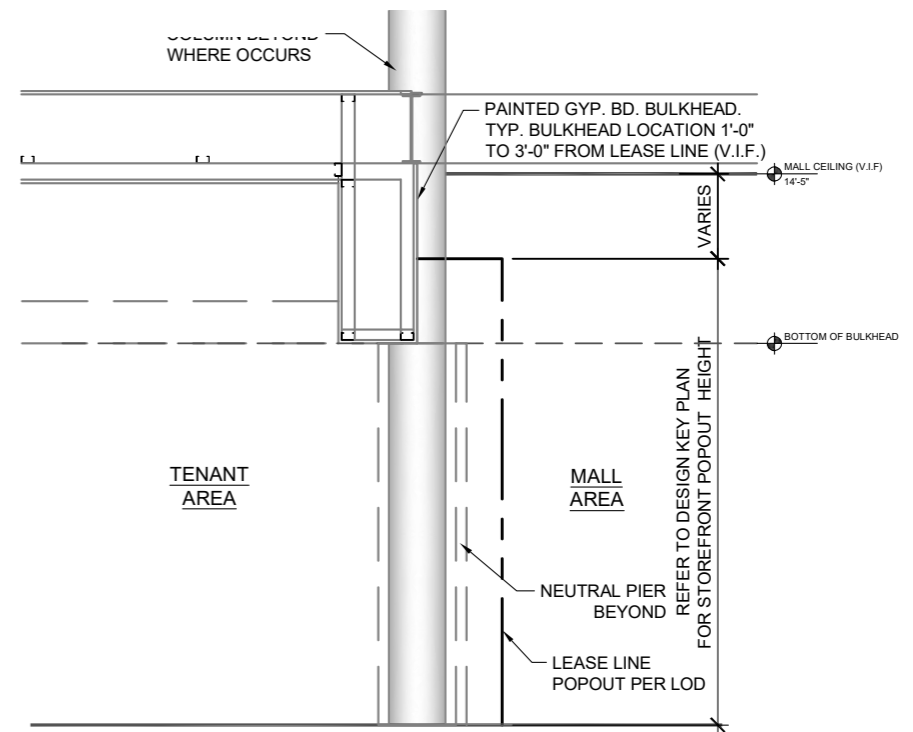

LOWER LEVEL STOREFRONT SECTION (TYP.)
NOT TO SCALE - TENANT TO VERIFY ALL EXISTING CONDITIONS

NEUTRAL PIER DETAILS - ZONE 2: LEVEL 2 TENANTS

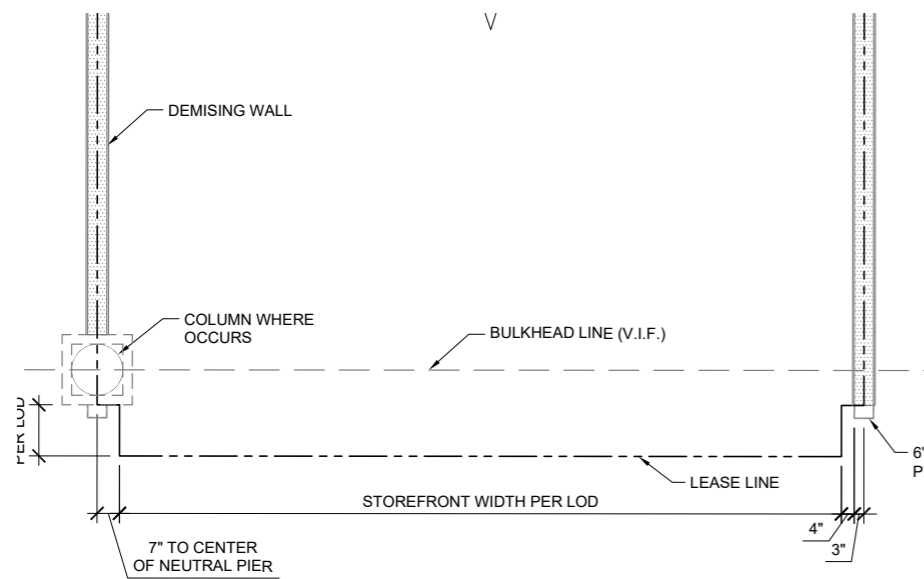
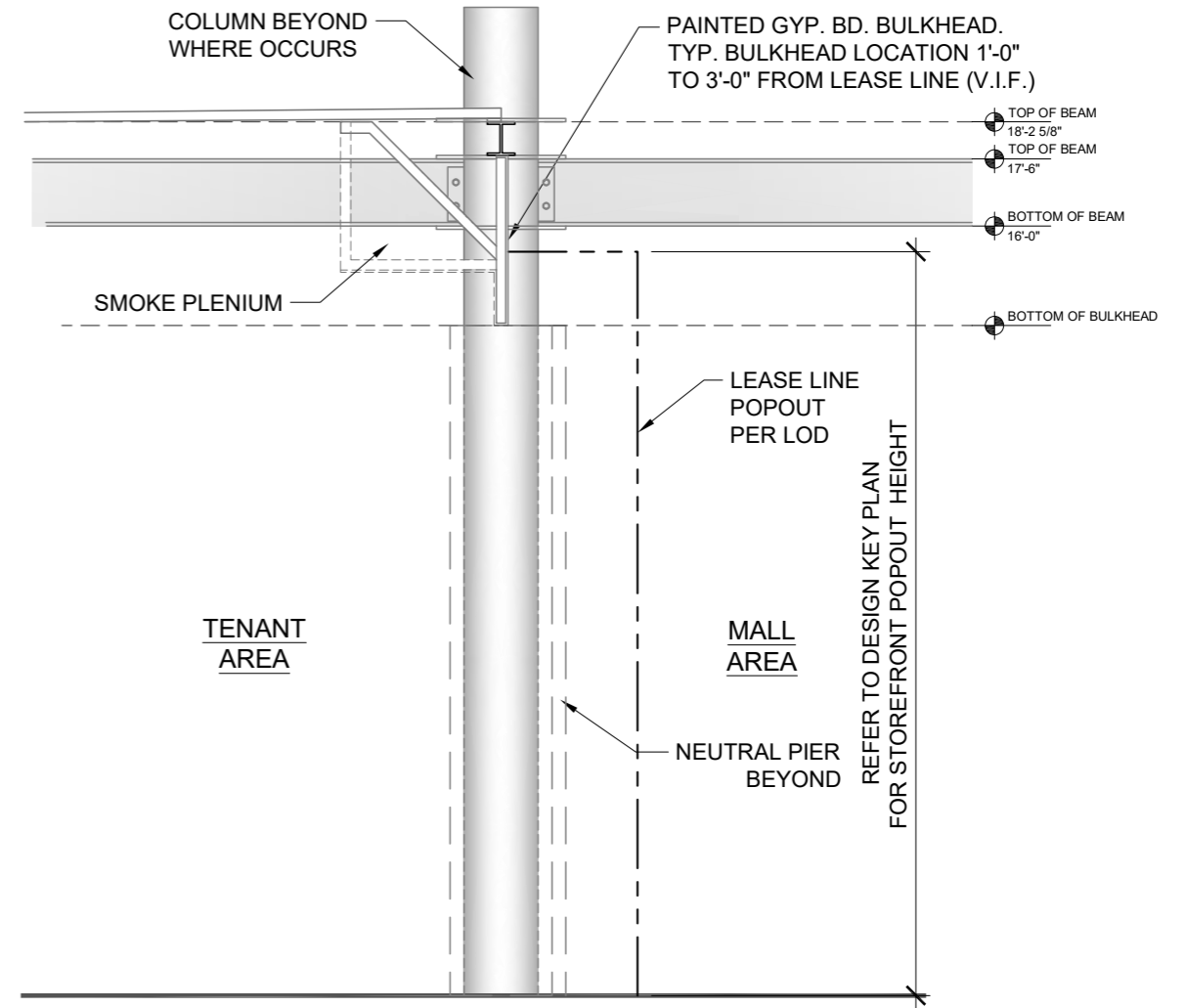
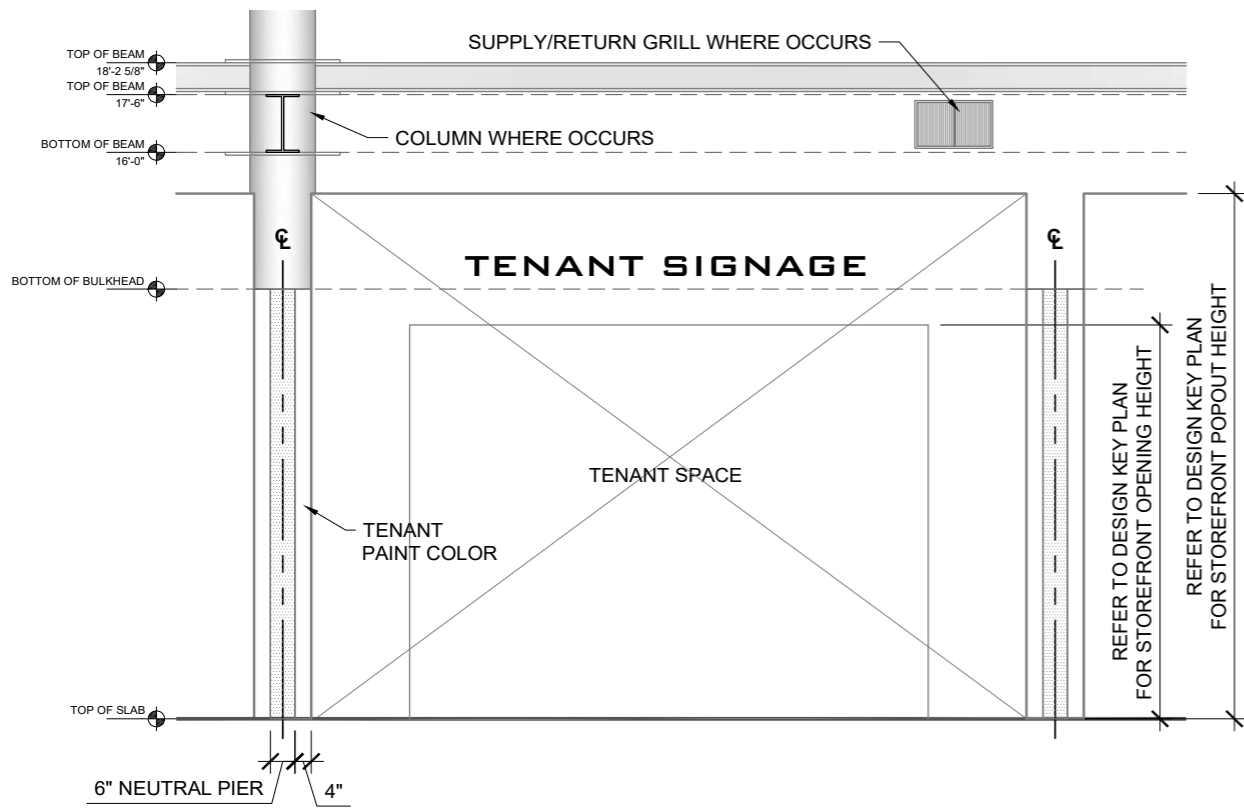

DESIGN INSPIRATION CONTENT OVERVIEW

5.1

VISUAL CONCEPTS

GUIDE TO DIFFERENT AESTHETIC CONCEPTS ENCOURAGING VIBRANT STORE DESIGNS.

5.2

KEY DESIGN ELEMENTS

OVERVIEW OF THE CORE DESIGN ELEMENTS TO EMBRACE WHEN CREATING AN ENLIVENING RETAIL EXPERIENCE.

The vibrant character of great shopping destinations is comprised of exceptional storefronts with texture, color, lighting, graphics and merchandising enlivening the pedestrian experience.

Tenants are encouraged to express their individuality and their brand identity through excellent design by forward thinking design teams.



VISUAL CONCEPTS > OVERVIEW

- ARTISAN
- URBAN
- WHIMSICAL
- INVITING
- ARTSY
- THEATRICAL

This section highlights six design concepts encouraged by Macerich for Tenants looking for additional inspiration. Our Design team welcomes Tenants to engage in these concepts and invites open collaboration in an effort to create store designs that enhance the retail experience.

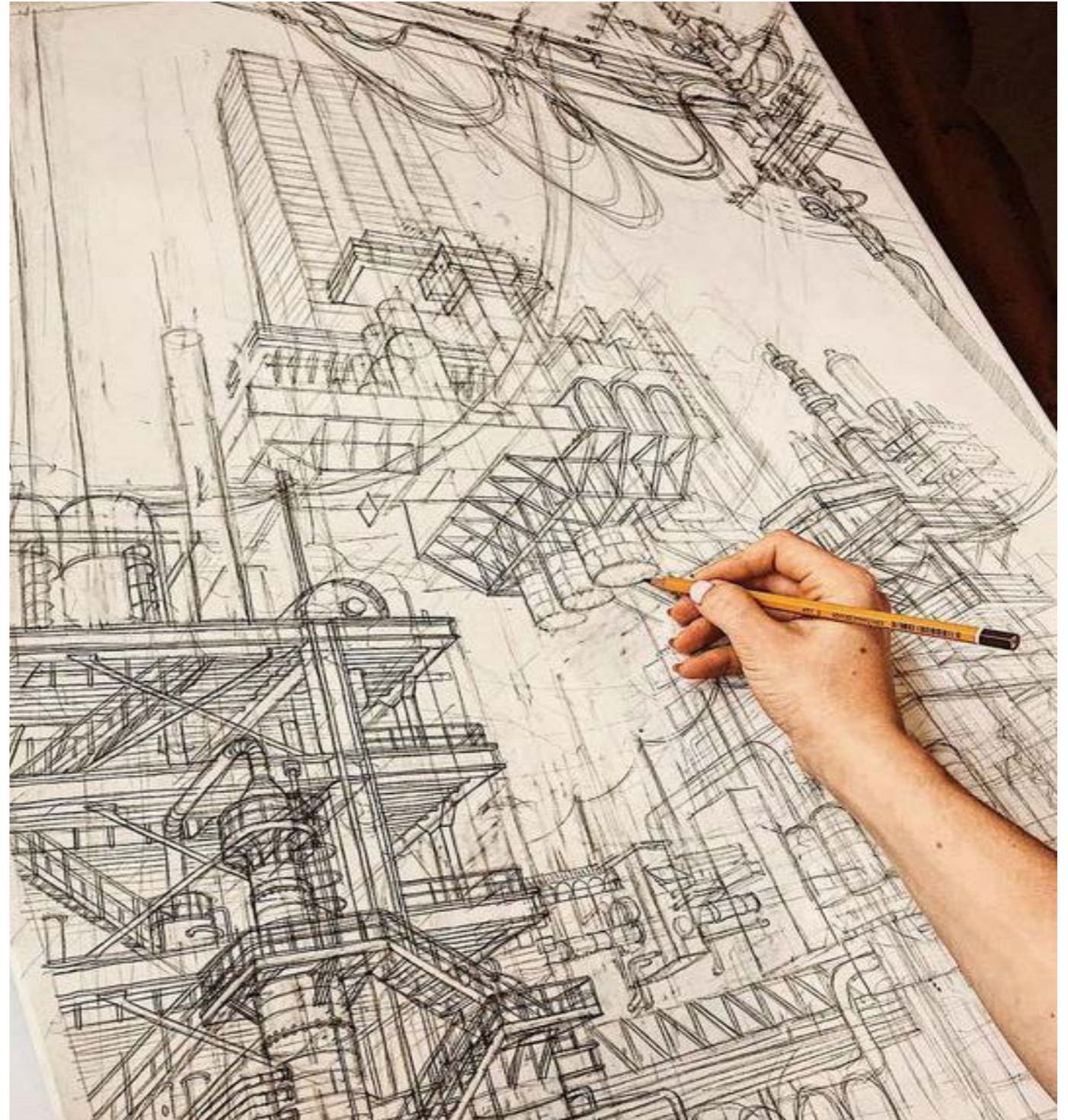

VISUAL CONCEPTS > ARTISAN

ARTISAN

NATURAL, SOPHISTICATED, UNIQUE



> URBAN

URBAN

EDGY, FUNKY, STREET SAVVY STYLE, INDUSTRIAL

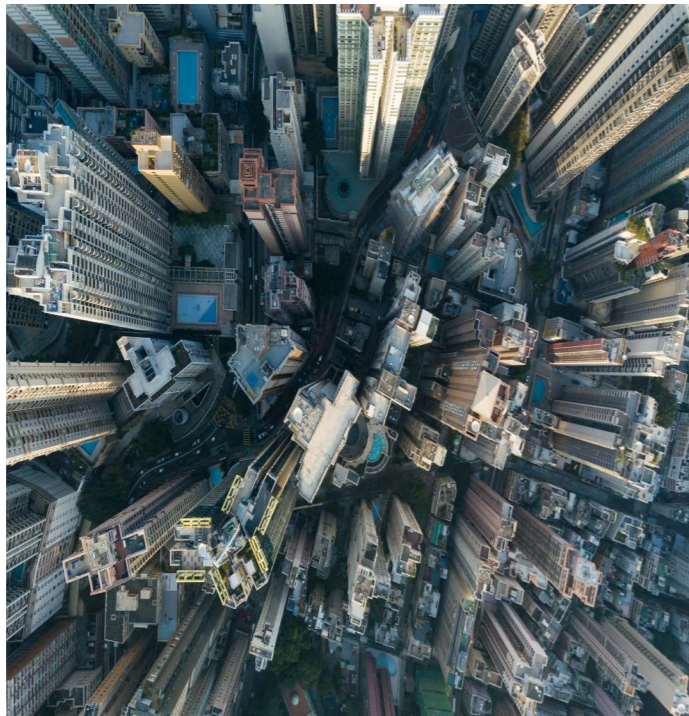

> WHIMSICAL

WHIMSICAL

UNEXPECTED, PLAYFUL, COLORFUL



> INVITING

INVITING
WARM, CALM, OPEN, SOFT



> ARTSY

ARTSY

QUIRKY, AVANT GARDE, SURPRISING



> THEATRICAL

T H E A T R I C A L
DRAMATIC, HIGH CONTRAST, MOVEMENT



KEY DESIGN ELEMENTS > BRANDING / VISUAL MERCHANDISING

Macerich embraces four key design elements to engage Customers and encourage Store traffic and sales. Strong use of textures, colors, lighting, graphics, and merchandising in these elements help draw Customers and invliven the pedestrian experience.

BRANDING

A brand is a name, term, design, symbol, color or some other feature that identifies a seller's product or services as distinct from those of other seller's.

Your branding can be communicated with signage, graphics, materials, shapes, colors, textures, patterns and the overall look and feel of your kiosk, to tell a story and create a lasting experience.



VISUAL MERCHANDISING

Strong visual presentation and merchandising are essential and integral components of retail design.

- Attempt to create triangular composition within style groups or color groups. (display in groups of three or five).
- Start with a center feature, (best sellers and hot items), and merchandise out symmetrically or asymmetrically in a balanced manner.



> LAYERING / TECH AND MEDIA

LAYERING

How can you make a wall / elevation into a canvas for communication to the Customer as they walk towards or by your store?

- Incorporating patterns and textures.
- Overlaying materials to create dimensionality.
- Molding shapes to create softness.
- Overlapping to create shadows and depth.



TECHNOLOGY AND MEDIA

Technology can enhance your online operation by transforming your retail space into a multifunctional one, that lends itself to being an in-store pick up location, payment booth or advertising billboard.

Integrating technology into your Store design can:

- Become an extension of you.
- Supplement your salesforce with interactive screens for ordering, self-design functions and more.
- Keep your business connected with your customer.
- Help you tell a story.
- Help make menu boards easier to update and better communicate your offerings to your Customer via LCD screen loops.

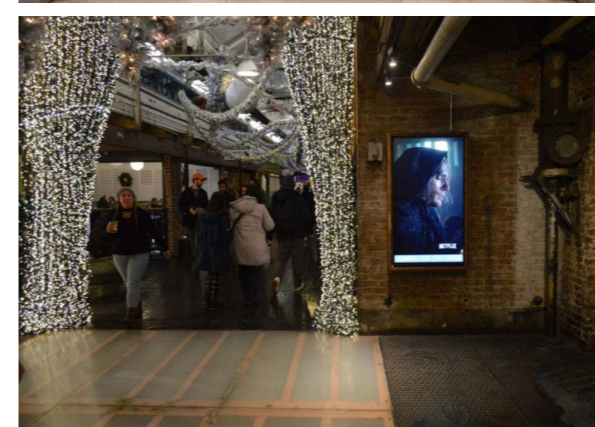

PROPERTY INFO CONTENT OVERVIEW

6.1 ADDRESS & HOURS

LOCATION AND SCHEDULE INFORMATION.

6.2 SITE PLAN

OVERVIEW MAP OF CENTER.

6.3 CONTACTS

MALL CONTACTS, REQUIRED CONTRACTORS, LOCAL MUNICIPALITIES, AND UTILITY CONTACT INFO.

6.4 CODES AND PERMITTING

OVERVIEW OF BUILDING CODE, CLASSIFICATIONS, AND LOCAL PERMITTING.

6.5 OPERATIONS AND UTILITIES

OVERVIEW OF CENTER OPERATIONS AND TYPICALLY AVAILABLE UTILITIES.

6.6 CONSTRUCTION

OVERVIEW OF CONSTRUCTION PROCEDURES.

SECTIONS OF INTEREST

The following sections provide additional details and requirements related to this Criteria:

ADDENDUM

Provides additional construction requirements to contractors.

The Property Info Criteria provides an overview of the Center's building classification, contacts, local permitting, and typically provided utilities.

It is important to note that the Contacts section includes the Center's required contractors. These contractors **must** be used during the design and buildout of your Store.

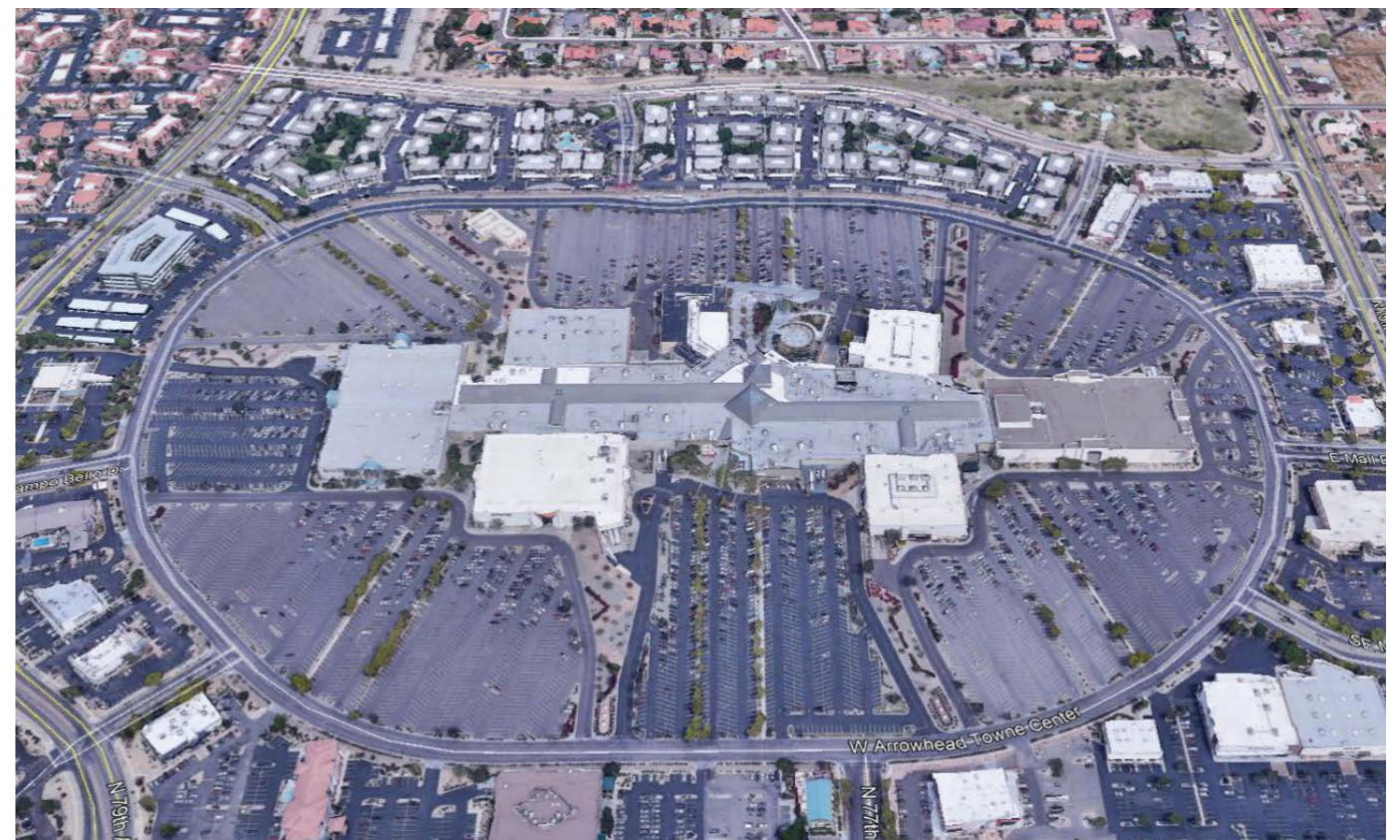

ADDRESS & HOURS

Arrowhead Towne Center is located at the Northeast corner of the Loop 101 Agua Fria Freeway and West Bell Road. The Center is open 7 days a week. Open hours for individual restaurants and entertainment venues may vary.

Center Address

7700 W. Arrowhead Towne Center
Glendale, AZ 85308

Center Hours

Monday-Saturday: 10:00am - 9:00pm

Sunday: 11:00am-6:00pm

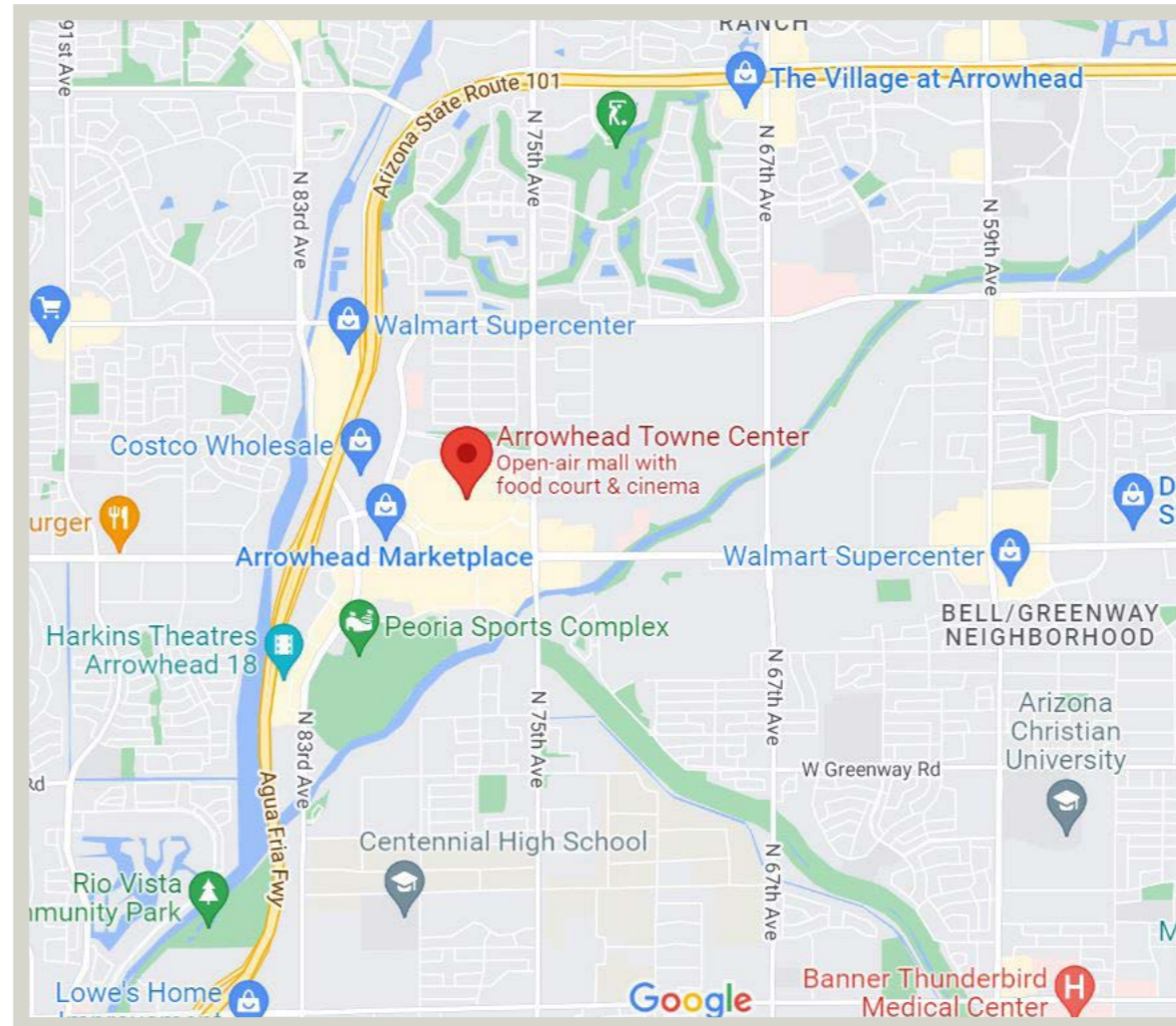

SITE PLAN

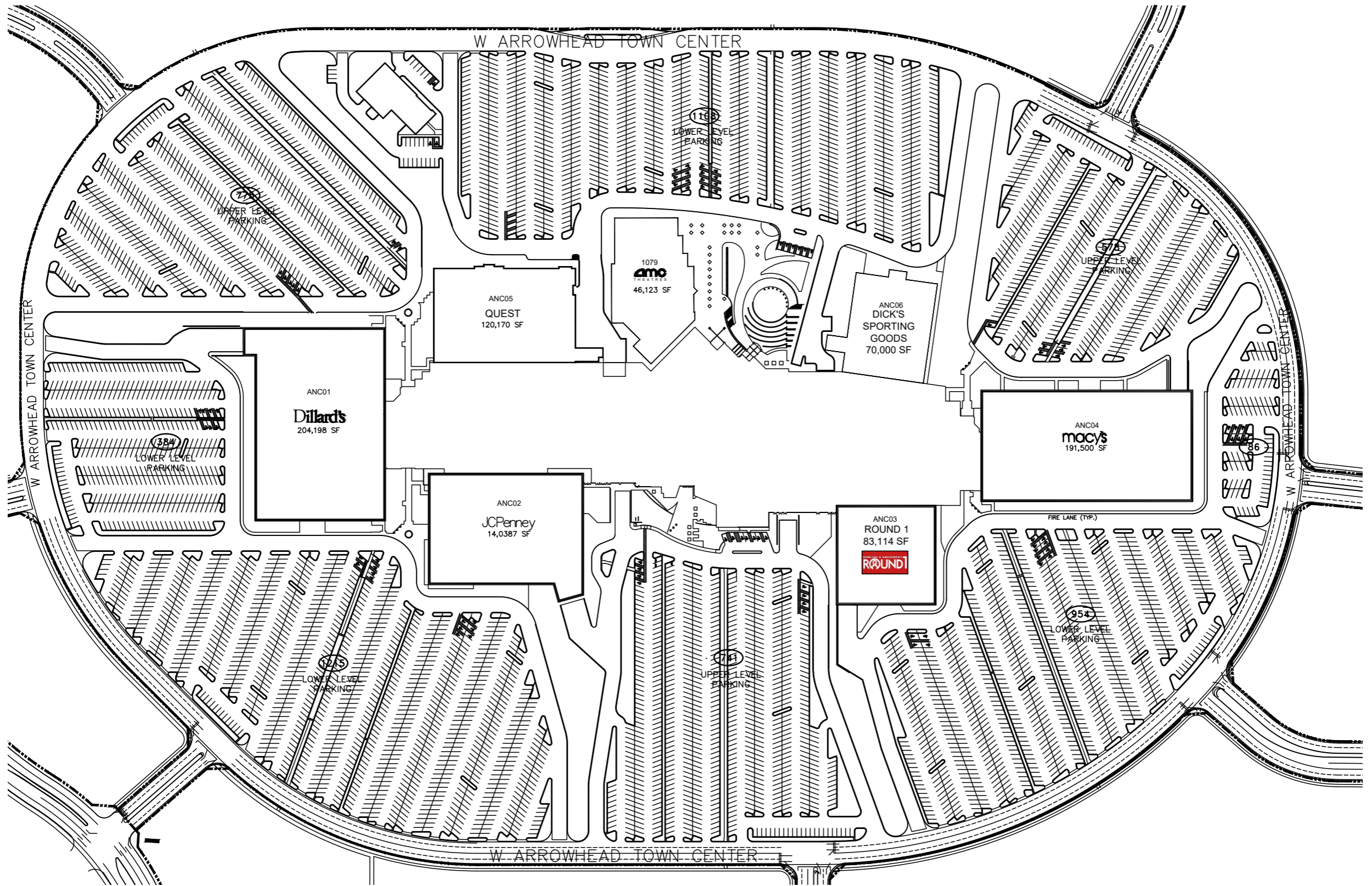

CONTACTS > PROPERTY TEAM / REQUIRED CONTRACTORS

PROPERTY TEAM

The following points of contacts are available to discuss site details and procedures. The primary point of contact for inquiries is the Tenant Coordinator.

PROPERTY MANAGER

Gabby Ochoa
(602)680-8672
gabby.ochoa@macerich.com

OPERATIONS MANAGER

Carlos Zarazua
(623) 979-7720
Carlos.Zarazua@macerich.com

TENANT COORDINATION

Charlene Sirokman
(602) 953-6377
Charlene.Sirokman@macerich.com

LEASING

John Otell
(602) 943-6423
John.Otell@macerich.com

LANDLORD/OWNER

The MACERICH Company
401 Wilshire Blvd., Suite 700
Santa Monica, CA 90401

REQUIRED CONTRACTORS

The following points of contacts are the required contractors that must perform the construction for their related field and/or systems. These contractors are required since they have intimate knowledge of the property building systems and can properly interface Tenant systems with the base building infrastructure.

FIRE SPRINKLERS

Johnson Controls
Andrel Neptune
(480) 369-6527
andrel.neptune@jci.com

FIRE ALARM

Johnson Controls
Andrel Neptune
(480) 369-6527
andrel.neptune@jci.com

ELECTRICAL (FOR FINAL CONNECTIONS)

TIE-IN to Landlord's Panel
Big T Electric
Rusty Topel
(480) 575-8565 Phone
bigtelectric@hotmail.com

ROOFING

Progressive Roofing
(602) 353-0098 Phone

DUMPSTER SERVICE

Provided Through Mall Operations Manager
(623) 979-7720 Phone

HVAC / EMS Tie In

Emcor Services
Jon Ogren
jogren@emcor.net
(602) 499-8891

VOICE / DATA SERVICE / LOW VOLTAGE

****It is highly recommended to coordinate service install a minimum of 4 weeks in advance.**
Thomas Roach
Granite Services
P: (781) 971-8370
M: (617) 529-6679
Troach@granitenet.com

CONTACTS > UTILITIES / LOCAL AGENCIES

UTILITIES

The following points of contact are required to set up utility accounts:

ELECTRICAL

APS

ANNA SMITH

Account Manager II

400 N. 5th St, Phoenix, AZ 85004, M.S. 8028

Office (602) 250-3558

Cell (623) 640-6178

anna.smith@aps.com

DATA

Data is required to be set up through Granite Grid. Other service providers do not have a Right of Entry agreement and are not permitted.

Granite Grid

****It is highly recommended to coordinate**

service install a minimum of 4 weeks in advance.

Thomas Roach

Granite Services

P: (781) 971-8370

M: (617) 529-6679

Troach@granitenet.com

GAS

Gas utility is only available for food use. Gas is not available for heating.

Southwest Gas

(602) 217-4277

WATER

City of Glendale

5850 W. Glendale Ave.

Glendale, AZ 85301

(623) 930-2730

LOCAL AGENCIES

The following points of contacts are the local agencies responsible for plan reviews and inspections:

BUILDING AND SAFETY

City of Glendale

Robert L. Juris

Building Safety Administrator

(623) 930-3172

rjuris@glendaleaz.com

HEALTH DEPARTMENT

Maricopa County Health Dept.

16140 N. Arrowhead Fountains Center Drive, Suite 105

Peoria, AZ 85382

(623) 939-5788

FIRE DEPARTMENT

Glendale Fire Dept.

6829 North 58th Drive

Glendale, AZ 85301

(623) 930-4420

BUSINESS LICENSING

City of Glendale

5850 W. Glendale Ave.

Glendale, AZ 85301

(623) 930-2730

CODES AND PERMITTING

BUILDING CODE OVERVIEW

Arrowhead Towne Center offers spaces for retail, restaurants, and entertainment. Below are the pertinent property details related to local building codes. It is the sole responsibility of the Tenant's Architect, Engineers, Consultants, and Contractors to comply with all applicable federal, state, and local codes and ordinances for their occupancy type.

Building Type

Two-level regional shopping center of approximately 1,197,870 square feet of gross leaseable area.

Approved Occupancy Types

Mercantile (M)

Construction Classification

Covered center building Type II-B construction, mercantile, with business and storage

Applicable Codes

2006 edition of the Uniform Building Code as amended and adopted by the City of Glendale, AZ.

PERMITTING

Tenant construction, signage, and food service all require permitting from City of Glendale.

I. BUILDING PERMIT

For all construction, prior to work commencement, building and other required permits shall be obtained by the Tenant.

Building Permits are filed with the City of Glendale. All City fees must be paid at the time of submittal, and those costs are determined at the time of submittal.

The average permit issuance timeframe to receipt of permit is approximately 45-60 days with a longer review period for food use tenants.

Any submittals made to the City of Glendale must include a digital stamp by the mall. The City will not accept any submittals without it.

II. SIGN PERMIT

Sign Permits are only required for exterior signage and are obtained through the City of Glendale, Building Department. All signage visible to the public is subject to review by the City of Glendale's Design Review Board.

All signage, both interior and exterior signage must be submitted to the Landlord for review and approval, and prior to City permit submittal, if applicable.

OPERATIONS AND UTILITIES

OPERATIONS

The following is a brief overview of the site infrastructure available during retail operations and construction.

1. PARKING - Employee parking is at the far end of the parking lot closest to the work site, no exceptions.
2. DELIVERIES - Only allowed before or after mall hours by their designated Service Areas nearest to the Tenant space. Preferably through a back door if the tenant space is equipped with one.
3. TRASH - Needs to be disposed of in General Contractor's designated Open Top container. If none is provided, then it needs to be disposed of in the nearest compactor closest to the Tenant space.

SITE UTILITIES AND SERVICES

The following is an overview of the utilities and services typically available for inline retail spaces. Please refer to lease language for any agreed upon changes that may overwrite these typical service provisions. It is the Tenant's responsibility to verify existing conditions and comply with all applicable codes and standards for all Technical systems.

I. ELECTRICITY

Tenant shell spaces typically provide conduit to a main power source.

All Mall electrical service is provided at 480V. Tenants are responsible to then step it down with a transformer to their desired specified Voltage.

II. DATA AND COMMUNICATIONS

Tenant shell spaces typically provide a conduit with pull string to nearest Granite rack.

Phone and internet services are provided on-site through Granite Grid.

Tenants must coordinate directly with Granite Grid to set up their data utility.

Other data providers do not have a right of access agreement and are not permitted access to the property.

III. SPRINKLER SYSTEM

Tenant shell spaces typically provide an automatic sprinkler system according to NFPA guidelines.

Tenants are responsible for contracting with the Landlord's required sprinkler vendor to adjust any existing grids, or install new if none exist, and tie into the main system.

IV. FIRE ALARM SYSTEM

Tenants are responsible for contracting with the Landlord's required fire alarm vendor to install all code-required alarm, horns, strobes, conduit within the Tenant's space to tie into the Landlord's main fire alarm panels.

V. WATER

Tenant shell spaces typically provide domestic cold water stubbed into the space. Size and location of the pipe varies per space. Spaces also typically provide a sanitary line stubbed into the space or located under the floor slab. Size and location of the line varied per space.

Water use is metered and charged by the Landlord for retail Tenants. A separate account with a water utility company is usually not required, unless Tenant is a food use.

VI. HVAC

Tenants are run by a VAV (Variable Air Volume) system supplied by Roof Top Air Handlers fed from our Central Plant. These are controlled by our Energy Management System that is being monitored by the Mall's HVAC Department.

VII. GAS

Gas utility is not available for in-line retailers.

The property does have a centralized gas service room available for food-use Tenants only.

CONSTRUCTION > PRE-CONSTRUCTION / CLOSE OUT

CONSTRUCTION

The following is a brief overview of the construction process and requirements for a tenant build outs:

WORKING HOURS

The working hours for all Tenant Contractors are from 7:00 AM to 3:30 PM Monday thru Friday with regulatory breaks in between. Any work outside the above hours must be approved in writing by the Center management. The Tenant Contractor shall be liable to make any arrangements and bear all costs and expenses associated with having other tradespersons present or available while work is carried out.

PRE-CONSTRUCTION

Prior to any construction commencement, the contractor's site superintendent is required to meet with the Landlord to review property construction requirements, submit construction documentation, and provide payment for property construction fees.

Required pre-construction documents include:

- Landlord Approved Construction Drawings
- Contractors Rules & Regulations to be completed and signed in full
- Approved GC Certificate of Insurance
- A copy of the Building Permit issued by the City
- General Contractor's state license
- Construction Progress Schedule
- Subcontractor List (include associated trade, contact name and phone number)

The Landlord will send a Preparedness Letter detailing the fees required for collection prior to scheduling this pre-construction meeting.

[CONTRACTOR RULES AND REGULATIONS](#) are linked in the [ADDENDUM](#).

CLOSE OUT

At construction completion, the Landlord will meet with the superintendent to perform a punch list walkthrough. The created punch list is required to be completed to the Landlord's satisfaction in order to close out the construction project. All construction charges must be paid in full. A reference [PUNCH LIST](#) is linked in the [ADDENDUM](#).

To complete closeout, the following documents are required to be submitted:

- Copy of Certificate of Occupancy or equivalent and Proof of Passing Final Inspections.
- Final list of Subcontractors (please make any changes or additions from the list supplied at pre-con)
- Unconditional Lien Waivers from all contractors, subcontractors and materials and service suppliers.
- Notarized Affidavit from General Contractor stating that no liens exist as a result of Tenant's work.
- Notarized AIA documents G702 & G703 (if the job is \$100,000.00 or more) / General Contractors Final Billing
- AABC or NEBB Certified Air Balance Report
- As-Built Documents (record set of what was constructed at the site, including Architectural, Structural, Mechanical, Plumbing, Electrical, Fire Protection, etc.) Electronic (PDF) format preferred.

SUBMITTAL CRITERIA CONTENT OVERVIEW

7.1

CONSTRUCTION DRAWINGS

SUBMITTAL REQUIREMENTS FOR ARCHITECTURAL AND TECHNICAL DESIGN DOCUMENTS.

7.2

SIGNAGE DRAWINGS

SUBMITTAL REQUIREMENTS FOR PRIMARY AND SECONDARY STOREFRONT SIGN DESIGNS.

7.3

KIOSK DRAWINGS

SUBMITTAL REQUIREMENTS FOR ARCHITECTURAL AND TECHNICAL KIOSK DESIGN DOCUMENTS.

The Submittals Criteria highlights the Landlord review process and drawing submittal requirements to ensure a quick and smooth drawing review for your design and construction drawings.

Tenant construction and signage drawings must be reviewed and Approved by the Landlord before the drawings can be submitted for permit. Permits from the local Municipality are required for all incoming Tenant construction and signage.

It is always the Tenant's responsibility to ensure:

- Compliance with the Lease document.
- Field verification of conditions and dimensions.
- Discrepancies between the drawings and the as-build conditions.
- Coordination with trades to ensure compliance with all local and national codes.

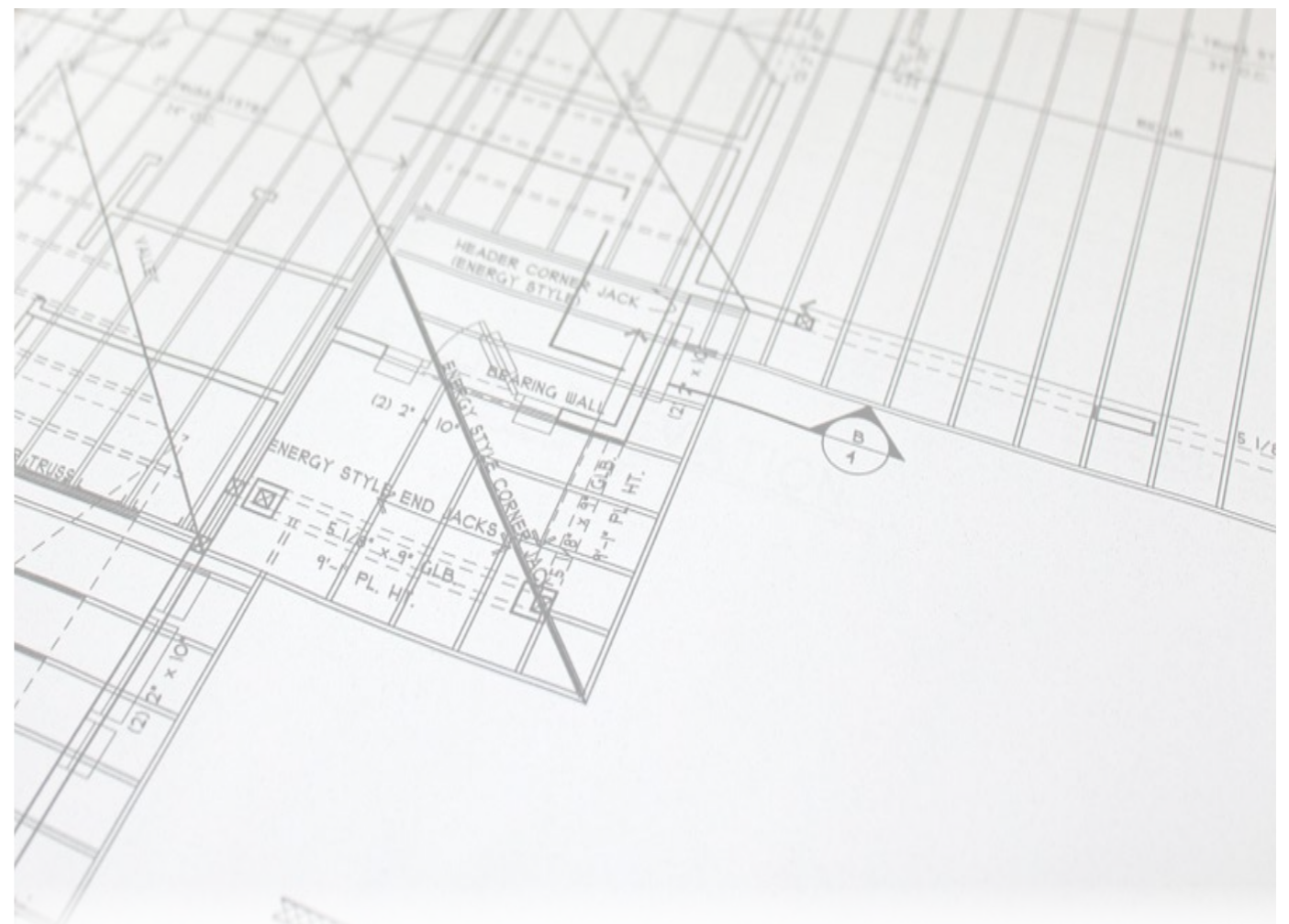

CONSTRUCTION DRAWINGS > PROCESS & TIMELINE

DRAWING REVIEW PROCESS

Drawing reviews are required to be submitted in two stages for Landlord review; Preliminary and final Construction Drawings. Preliminary drawings are required to ensure the design process moves quickly by ensuring that all Criteria requirements are understood and adopted early in the design. This helps ensure an expedited review of the final Construction Drawings.

REVIEW TIMELINE

Step	Action	Time Period
1	Tenant submits preliminary design.	Required 20 days after Lease Execution or 10 days following previous submittal disapproval.
2	Landlord Approved Preliminary Design.	15 days after confirmed completion of Step #1.
3	Tenant submits final construction drawings.	Required 20 days after Tenant Coordinator approval at Step #2.
4	Landlord Approves final documents.	15 days after completion of Step #3.
5	Tenant submits drawings for permit. (If applicable)	5 days after confirmed completion of Step #4.
6	Tenant responds to any requests from or comments by permitting jurisdiction.	5 days.
7	Upon permit review approval, Tenant pays all fees and logs out permit.	5 days.

> SUBMITTAL REQUIREMENTS > PRELIMINARY

PRELIMINARY DESIGN SUBMITTAL

The Preliminary Document review process will evaluate all the criteria discussed in this manual, including overall three-dimensional form, degree of design uniqueness and identity, use and detailing of materials, colors and lighting, and integration of signage and graphics.

Submittals are to provide the reviewer with a clear understanding of proposed design concepts.

The submission must be complete in order to fairly evaluate the proposal and prevent continuation of work on an unacceptable design.

Copies of all drawings are to be sent to the Tenant Coordinator via email.

Tenant shall submit to Landlord at tcphoenix@macerich.com an electronic PDF files of the following:

- **Color and Material Sample Board**
Include actual samples of all Tenant colors and materials visible to the public, on a digital sample board. Clearly label all materials and reference to floor plan elevations.
- **Perspective and/or Photo Image(s)**
Colored perspective rendering and/or prototypical photo images of the proposed storefront, including graphics and signage.
- **Cover Sheet**
Include: Name of Tenant, name of Mall or Center, space number, Applicable Codes, Building Type and Occupancy Type, Leased square footage, and Key Plan.
- **Floor Plan**
¼" Scale Minimum showing: Entire lease dimensioned space with room names, floor finishes, casework and fixture locations.
- **Reflected Ceiling Plan**
¼" Scale Minimum showing: Lighting design, including fixture types and locations, signage, access panels, Overhead projections such as light coves and fascia systems, and Entrance.
- **Sections**
1" Scale Minimum showing: Entry, Display windows and fascia, Sign integration into storefront design.
- **Storefront Elevations**
½ Scale Minimum showing: Exterior views - front and sides, Signs, graphics, logos.

A physical sample board is also required, mounted on foam core or card stock to be sent in coordination with your Tenant Coordinator.

> SUBMITTAL REQUIREMENTS > FINAL

FINAL DRAWING SUBMITTAL

After Preliminary Drawing Approval, it is critical to quickly complete and submit Final Construction Drawings for Landlord review.

If any questions arise from the Tenant's interpretation of the design and criteria information, the Tenant shall assume all responsibility for clarification by written request to the Tenant Coordinator. The Landlord plan review and approval process is independent of local permitting for construction. The Tenant is responsible for procurement and compliance with local, state and federal codes and requirements.

Copies of all drawings are to be sent to the Tenant Coordinator via email.

Tenant shall submit to Landlord at tcphoenix@macerich.com an electronic PDF files of the following:

- **Responsibility Schedule**
Any work, which is the Landlord's responsibility, must be listed clearly on a responsibility schedule on the cover sheet.
- **Cover sheet**
Include a Key Plan, Name of Tenant, name of Mall or Center, space number and location leased premises within Mall or Center, Applicable codes, building type and occupancy type, Leased square footage, Responsibility schedule, and Drawing index.
- **Floor Plans**
¼" Scale Minimum showing: Entire lease space with room names, Floor finishes, casework and fixture locations, and Demolition plan.
- **Reflected Ceiling Plan**
¼" Scale Minimum showing: Complete lighting design, including fixture types and locations, signage, access panels, Overhead projections such as light coves and fascia system, Entry, Connection to Landlord's work, Tenant's framing and/or additional structure showing freestanding from Landlord's structure.
- **Sections**
1" Scale Minimum showing: Entry, Display windows and fascia, Sign integration into storefront design, Connection to Landlord's work, Tenant's framing and/or additional structure showing freestanding from Landlord's structure.
- **Interior Elevations**
¼" Scale Minimum showing: All sales floor interior views, Built-in casework, signage, and display systems.
- **Storefront Elevations**
½" Scale Minimum showing: Exterior views - front and sides, Signs, graphics, logos, Landlord neutral piers, Storefront finishes (to be referenced to finish schedule)
- **Architectural Details**
½" Scale Minimum.
- **Door Schedule**
Include floor transition details and anti-theft security system details.
- **Details, Catalogue Cut Sheets, and Fixture Finishes**
- **Finish & Color Schedule**
- **Include CAD/DWG drawing files as part of drawing submission including: Demo plan, Floor plan, MEP plans, and Life safety/ Egress Plans. Please include any background drawings that are necessary to view these files as a comprehensive whole.**

> SUBMITTAL REQUIREMENTS > FINAL ENGINEERING

FINAL DRAWING SUBMITTAL - ENGINEERING DRAWINGS

The Landlord does not review for mechanical, electrical, plumbing, or structural design, nor does the Landlord accept responsibility for the Tenant's adherence to governing codes.

Tenant shall submit to Landlord at tcphoenix@macerich.com an electronic PDF files of the following engineering drawings included in the final drawing set:

Copies of all drawings are to be sent to the Tenant Coordinator via email.

I. MECHANICAL DESIGN DOCUMENTS

- Make, type, and performance of all equipment.
- Sign and seal by a Licensed Engineer in the state where the Shopping Center is located.
- Calculations showing the heating and cooling required, including transmission and ventilation losses in the space, and heat and cooling provided for the ventilation supply, and exhaust required for the space. Calculations must be performed in accordance with the latest ASHRAE standards and tabulated in a concise, orderly manner.
- Temperature control system data showing make, control, and energy management systems.
- Exhaust system layout including CFM and equipment specifications.
- Reflected ceiling plan showing HVAC equipment.
- Roof plan with equipment locations.
- Structural details for support of all rooftop equipment and equipment suspended from the steel structure.

II. PLUMBING DESIGN DOCUMENTS

- Make, type, and performance of all equipment.
- Sign and seal by a Licensed Engineer in the state where the Shopping Center is located.
- Complete plumbing system design and floor plan for the Tenant space including, but not limited to the toilets, sinks, urinals, drains, hot water heaters, water coolers, grease trap/interceptors and connections into existing water and sewer lines.
- Single line diagram.
- Fixture schedule.
- Water heater detail as applicable.
- Grease trap cut sheets as applicable.

III. FIRE PROTECTION / SMOKE EVACUATION DESIGN DOCUMENTS

- Reflected ceiling plan, with revised sprinkler head locations.
- Design must be City approved before construction

IV. ELECTRIC DESIGN DOCUMENTS

- Sign and seal by a Licensed Engineer in the state where the Shopping Center is located.
- Panel schedules, load calculations, and meter information, if applicable.
- Structural drawings for all equipment that will be suspended from the steel structure.
- Electrical load summary and Title 24 Energy Calculations (for State of California).
- Floor plan depicting equipment locations and branch circuitry.
- Reflected ceiling plan depicting the layout of light fixtures.
- System one line diagrams.
- Lighting fixture schedule.
- Equipment legend.

V. STRUCTURAL DESIGN DOCUMENTS

- Design elements affecting the structure of the base building.
- Alterations, additions, modifications and reinforcements to the base building which shall be required to accommodate Tenant's Work.
- All calculations & details (Include ICBO numbers on all framing details, Seismic bracing details for State of California.)
- All forms required by governmental agencies and Governmental Regulations, fully and properly completed and executed by Tenant.
- Partial structural framing plan showing existing conditions for new and existing rooftop installations and proposed reinforcement, which shall be accompanied by structural engineers' calculations, drawn on a scale of 1/2"=1'0".
- Ceiling, soffits, storefront attachment details to existing base building.
- A letter from a state-registered structural engineer certifying that all new equipment and design elements serving the Premises are adequately supported to carry the new load.

SIGNAGE DRAWINGS > PROCESS & TIMELINE

DRAWING REVIEW PROCESS

Sign drawing reviews are required to be submitted in two stages for Landlord review; Preliminary and final Construction Drawings. Preliminary drawings are required to ensure the design process moves quickly by ensuring that all Criteria requirements are understood and adopted early in the design. This helps ensure an expedited review of the final Construction Drawings.

REVIEW TIMELINE

Step	Action	Time Period
1	Tenant submits preliminary design.	Required 20 days after Lease Execution or 10 days following previous submittal disapproval.
2	Landlord Approved Preliminary Design.	15 days after confirmed completion of Step #1.
3	Tenant submits final sign drawings.	Required 20 days after Tenant Coordinator approval at Step #2.
4	Landlord Approves final documents.	15 days after completion of Step #3.
5	Tenant submits drawings for permit. (If applicable)	5 days after confirmed completion of Step #4.

> SUBMITTAL REQUIREMENTS > PRELIMINARY, FINAL

PRELIMINARY DESIGN SUBMITTAL

The Preliminary Document review is intended to acquaint the Landlord with the Tenant's signage design intent.

Submittals are to provide the reviewer with a clear understanding of proposed design concepts.

The submission must be complete in order to fairly evaluate the proposal and prevent continuation of work on an unacceptable design.

Tenant's licensed sign contractor shall submit to the Center's Tenant Coordinator electronic PDF files of the following:

- **Perspective and/or Photo Image(s)**
Colored perspective rendering and/or prototypical photo images of the proposed storefront, including graphics and signage.
- **Storefront Elevations**
½ Scale Minimum showing: Exterior views - front and sides, Signs, graphics, and logos highlighting sign dimensions and materials.

FINAL DRAWING SUBMITTAL

After Preliminary Drawing Approval, it is critical to quickly complete and submit Final Construction Drawings for Landlord review.

If any questions arise from the Tenant's interpretation of the design and criteria information, the Tenant shall assume all responsibility for clarification by written request to the Tenant Coordinator. The Landlord plan review and approval process is independent of local permitting for construction. The Tenant is responsible for procurement and compliance with local, state and federal codes and requirements.

The Landlord does not accept responsibility for the Tenant's adherence to governing codes or verification of job site conditions.

Tenant's licensed sign contractor shall submit to the Center's Tenant Coordinator electronic PDF files of the following:

- Elevation of the storefront including signage and graphics; showing all doors, architectural features, etc., and fully detailed/dimensioned sections and details through the storefront.
- These fully detailed and dimensioned drawings shall be drawn to scale as noted:
 - Storefront Plan, Elevation and Sectional views at 1/2 inch scale.
 - Details of the Signage at 1/2 inch scale or larger.
 - Storefront Signage at 1/2 inch scale.
- Letter style and typeface specifics.
- Color and finish qualities of all portions of signage.
- Material specifications and thickness.
- Transformer specifications, including input and output voltage of transformers. PK housing, (or other UL approved insulating sleeve approved by Landlord and local building codes), is required for all through wall penetrations and must be indicated on the sign shop drawings. Wiring specifications.
- Locations of service switches, access panels and transformers. NONE of these items shall be visible to the public from any portion of the Mall.
- Neon tube specifications, including color and dimension (in mm) of tubes to be used.
- Type of lamps.
- Mounting hardware.

KIOSK DRAWINGS > PROCESS & TIMELINE

DRAWING REVIEW PROCESS

Kiosk drawing reviews are required to be submitted in two stages for Landlord review; Preliminary and final Construction Drawings. Preliminary drawings are required to ensure the design process moves quickly by ensuring that all Criteria requirements are understood and adopted early in the design. This helps ensure an expedited review of the final Construction Drawings.

REVIEW TIMELINE

Step	Action	Time Period
1	Tenant submits preliminary design.	Required 20 days after Lease Execution or 10 days following previous submittal disapproval.
2	Landlord Approved Preliminary Design.	15 days after confirmed completion of Step #1.
3	Tenant submits final construction drawings.	Required 20 days after Tenant Coordinator approval at Step #2.
4	Landlord Approves final documents.	15 days after completion of Step #3.
5	Tenant submits drawings for permit.	5 days after confirmed completion of Step #4.

> SUBMITTAL REQUIREMENTS > PRELIMINARY, FINAL

PRELIMINARY DESIGN SUBMITTAL

The Preliminary Document review is intended to acquaint the Landlord with the Tenant's signage design intent.

Submittals are to provide the reviewer with a clear understanding of proposed design concepts.

The submission must be complete in order to fairly evaluate the proposal and prevent continuation of work on an unacceptable design.

Tenant's licensed architect shall submit to Landlord at tcphoenix@macerich.com an electronic PDF files sized 24" x 36" format of the following on:

- Colored perspective rendering and/or prototypical photo images of the proposed kiosk, including graphics and signage.
- A material sample board, (8-1/2" x 11" minimum), clearly noting the Tenant name and Mall name.
- A floor plan.
- Sections and elevations of the kiosk.

FINAL DRAWING SUBMITTAL

After Preliminary Drawing Approval, it is critical to quickly complete and submit Final Construction Drawings for Landlord review.

If any questions arise from the Tenant's interpretation of the design and criteria information, the Tenant shall assume all responsibility for clarification by written request to the Tenant Coordinator. The Landlord plan review and approval process is independent of local permitting for construction. The Tenant is responsible for procurement and compliance with local, state and federal codes and requirements.

The Landlord does not accept responsibility for the Tenant's adherence to governing codes or verification of job site conditions.

Tenant's licensed architect shall submit to Landlord at tcphoenix@macerich.com an electronic PDF files sized 24" x 36" format of the following on:

- A cover sheet including a vicinity map, location map, (LOD), all code compliance notes as required by the city.
- Floor plan detailed and scaled, showing all components, counters, cash wraps, islands, condiment area layout, partitions etc.
- All finishes and fixtures with complete schedules and keyed plans and elevations.
- Details and sections of each side as well as the pylon, counter edge, millwork, toe kick, raised flooring, wall caps, special conditions etc.
- All interior and exterior elevations, with sign locations and dimensions.
- Anything necessary to describe structures or design features, not depicted or easily understood.
- Electrical drawings including a plan layout.
- Plumbing drawings, if applicable.
- Equipment schedule and finish schedule.
- Sign shop drawings, with plan, elevations, sections, materials and details.

ADDENDUM LINKS

This Addendum contains links to supplemental documents of specific requirements and information. These documents are considered part of the Tenant Criteria Package. Clicking the links below will navigate to the described documents. It is the responsibility of the Tenant, its contractors, subcontractors, architects, engineers, employees, and agents to comply with terms of the Tenant Criteria, Addendum included.

GLOSSARY

I. [GLOSSARY OF TERMS](#)

Defines commonly used terms for clarity.

DESIGN ADDENDUM

I. [MACERICH SUSTAINABILITY HANDBOOK](#)

Guide to encourage energy efficient, sustainable design.

II. [UNIT UTILITIES AS BUILT CHECK LIST](#)

Helpful checklist for reference during a site survey.

III. [SPECIALTY LEASING CRITERIA](#)

Design requirements for temporary Tenant's buildout and signage.

BARRICADE ADDENDUM

I. [BARRICADE GUIDELINES](#)

Guide to installing and activating construction barricades with graphics.

SIGNAGE ADDENDUM

I. [DIGITAL SIGN CRITERIA](#)

Design requirements for Tenant's digital signage.

CONSTRUCTION ADDENDUM

I. [CONTRACTOR RULES AND REGULATIONS](#)

Document detailing the rules and regulations Tenant contractors must adhere to during their construction. This document must be reviewed and signed by the Site Superintendent overseeing the Tenant build out.

II. [HOT WORK PERMIT](#)

Required form to submit when construction required hot work.

III. [PUNCH LIST](#)

Reference Landlord Punchlist that that Landlord will use to inspect and confirm completion of Tenant construction.