

CASH/WRAP END
 NORTH BRIDGE RMU
 Sand Mountain, Inc. 1/1/04

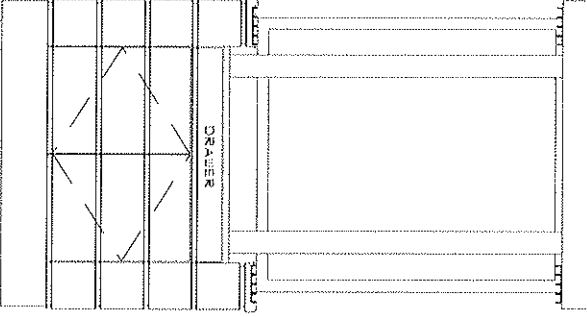

FRONT ELEVATION
 NORTH BRIDGE RMU
 Sand Mountain, Inc. 1/1/04

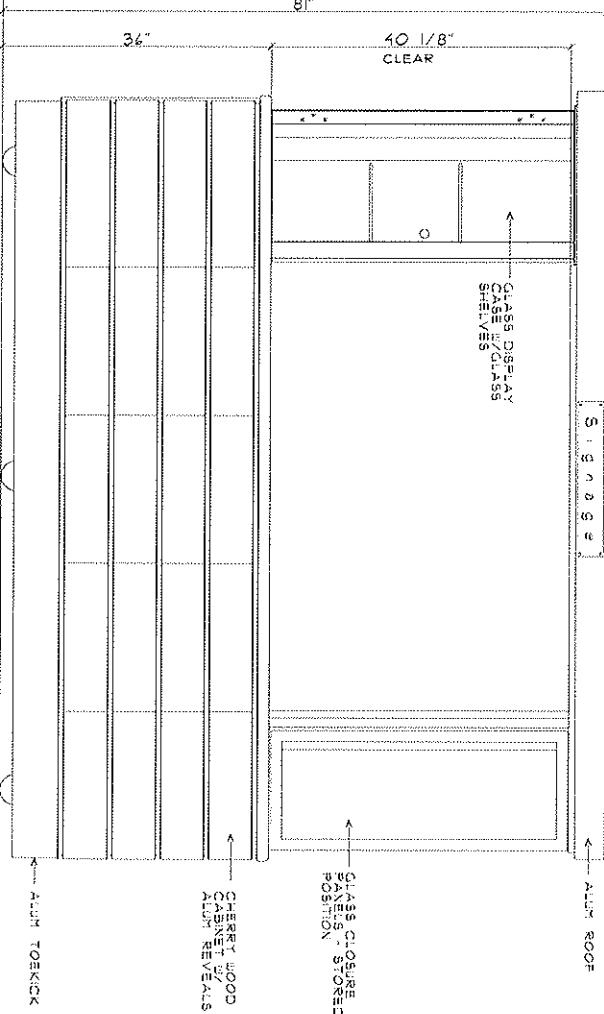

COUNTER PLAN
 NORTH BRIDGE RMU - LEFT
 Sand Mountain, Inc. 1/1/04

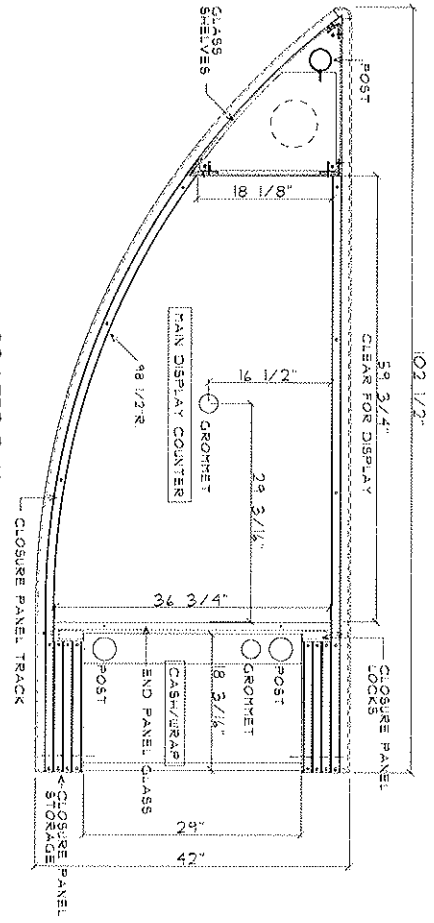

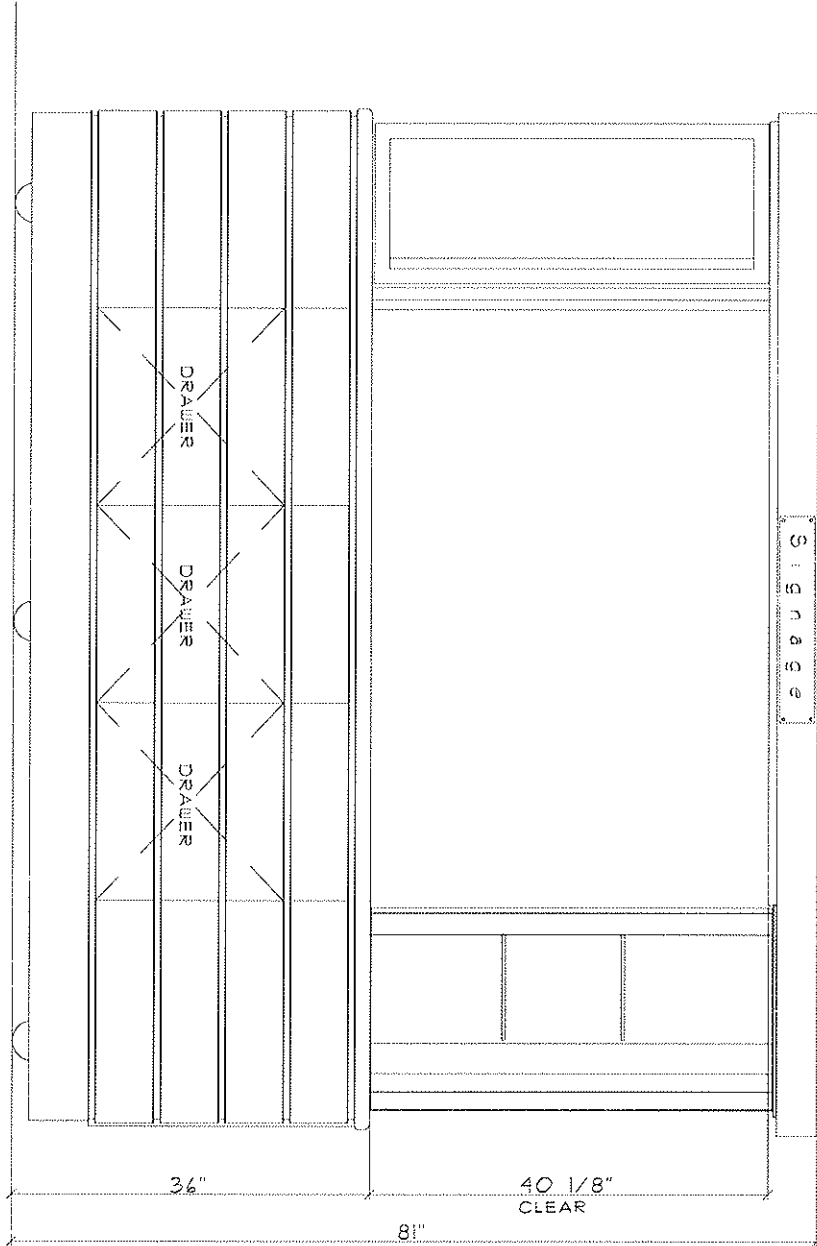

BACK ELEVATION
 NORTH BRIDGE RYU
 Sand Mountain, Inc. - 6/1/04

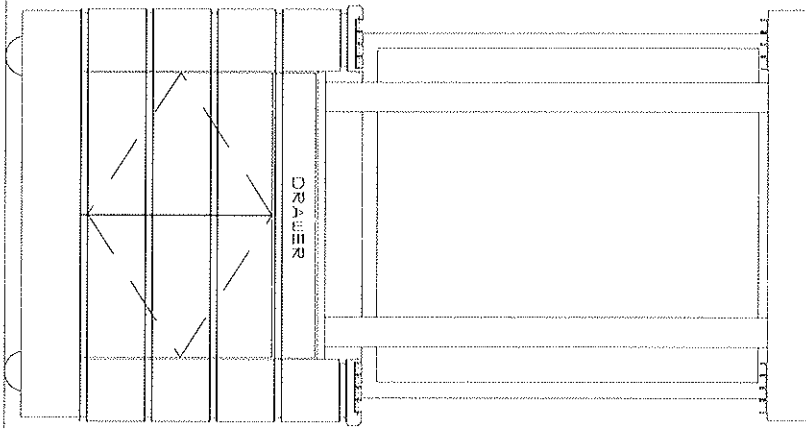

CASH/WRAP END
 NORTH BRIDGE RYU
 Sand Mountain, Inc. - 6/1/04

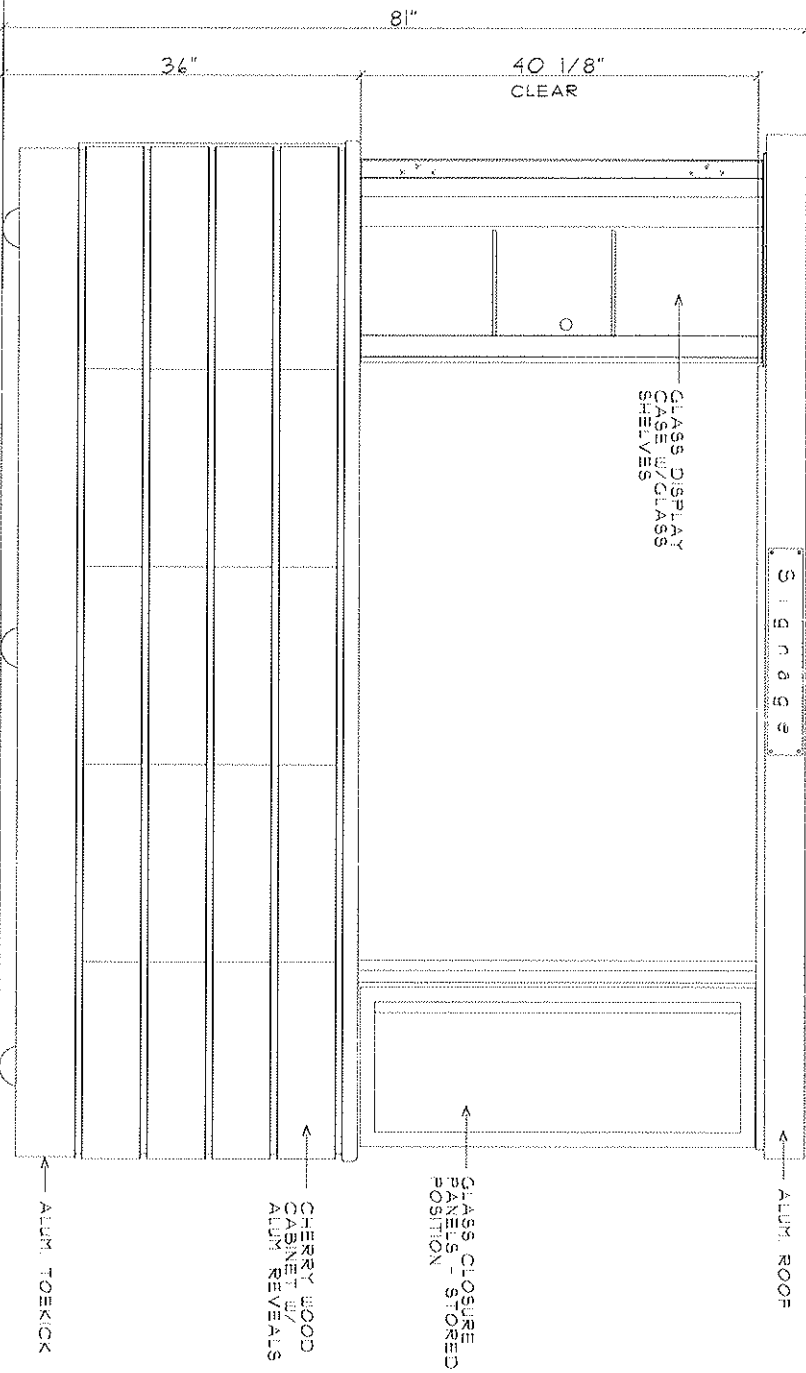

FRONT ELEVATION
 NORTH BRIDGE RYU
 Sand Mountain, Inc. - 6/1/04

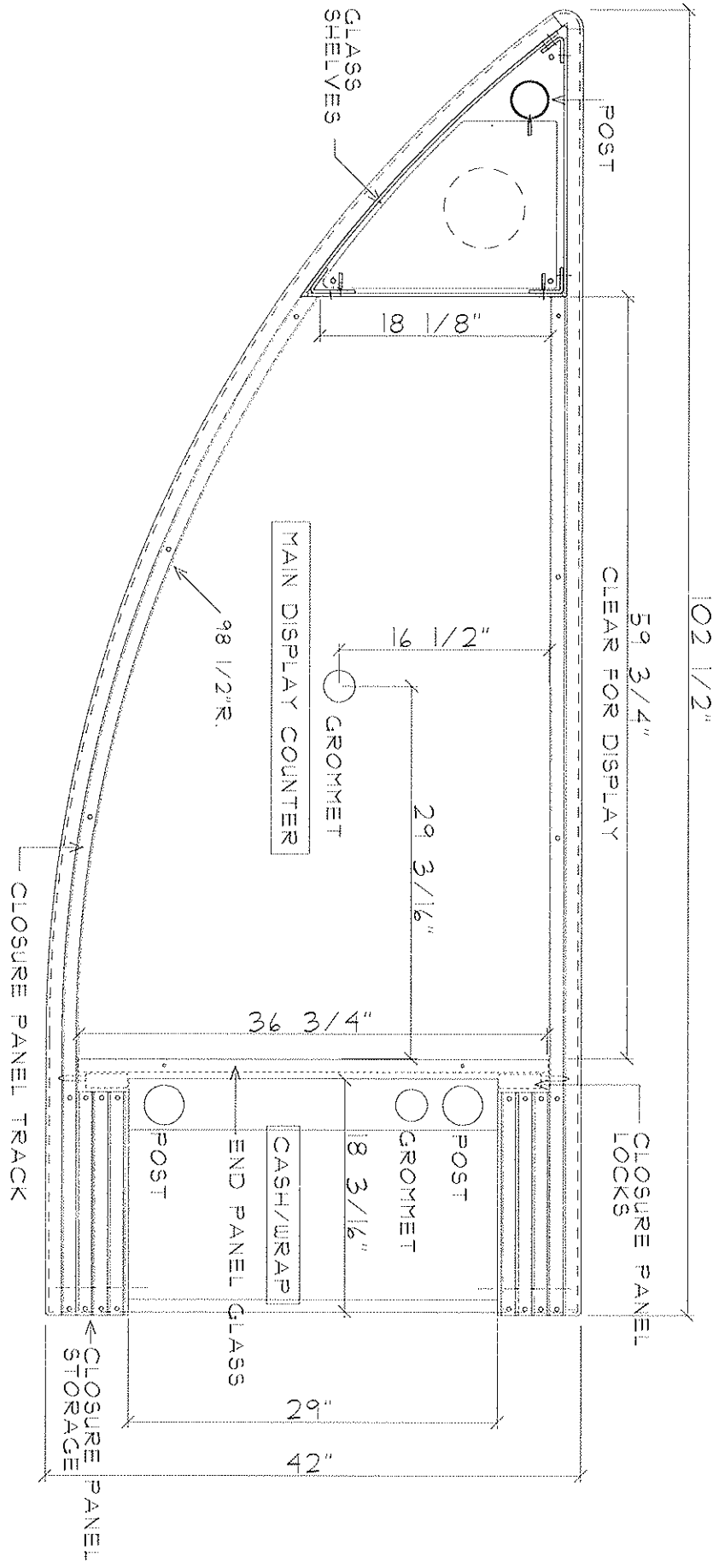

COUNTER PLAN
 NORTH BRIDGE RMU - LEFT
 Sand Mountain, Inc. - 6/1/04

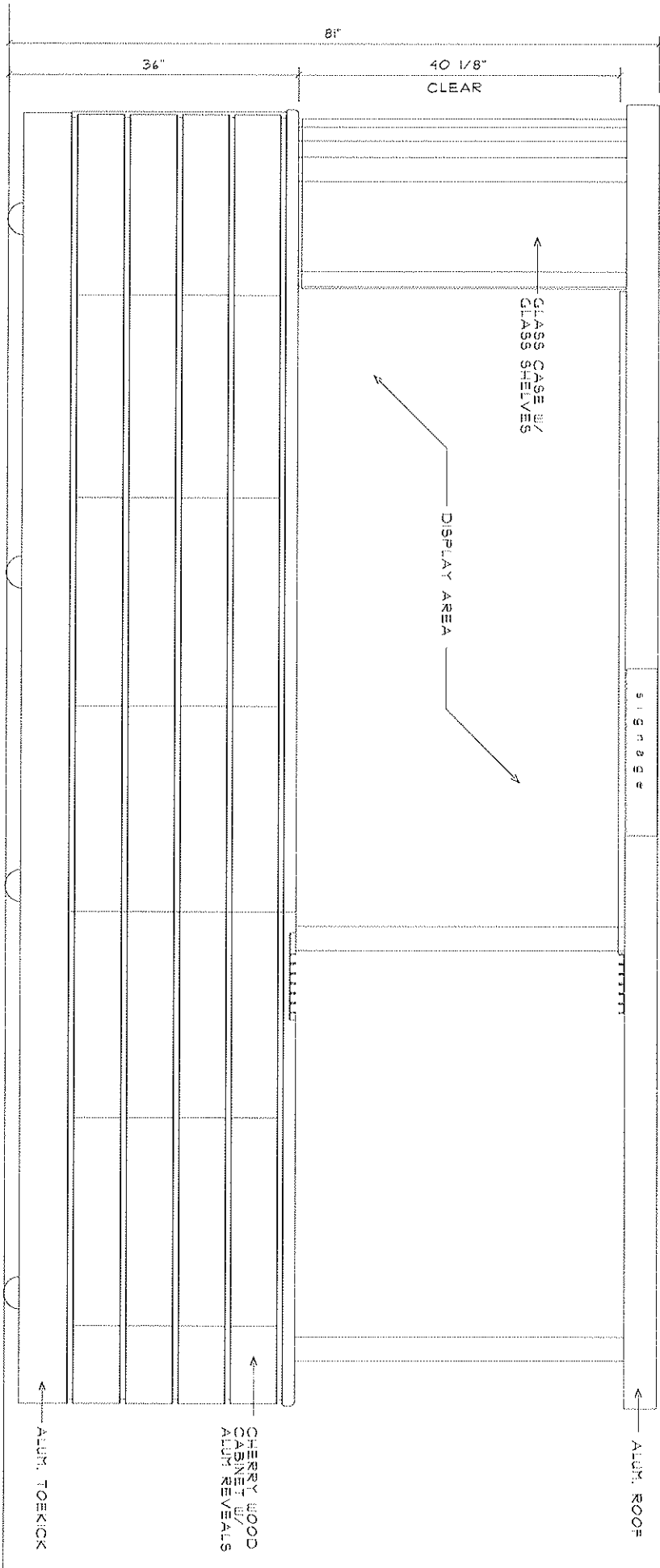

FRONT ELEVATION
 NORTH BRIDGE RNU-LARGE
 Sand Mountain, Inc. 6/1/04

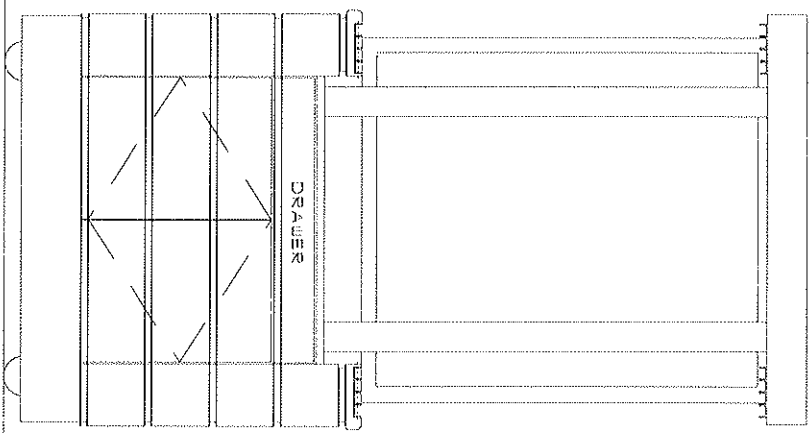

CASH/WRAP END
 NORTH BRIDGE RYU
 Sand Mountain, Inc. - 6/1/04

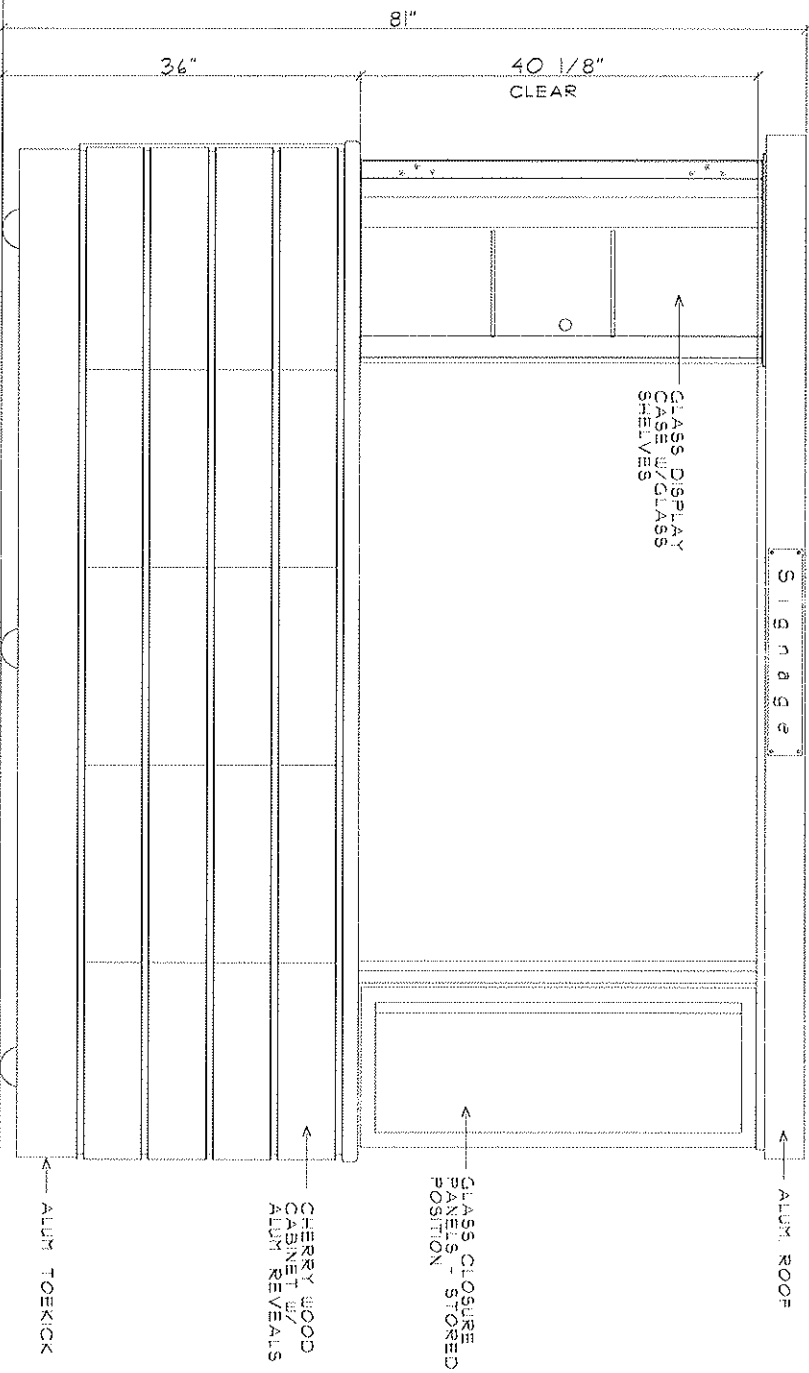

FRONT ELEVATION
 NORTH BRIDGE RYU
 Sand Mountain, Inc. - 6/1/04

